

TRIPOD EASEL SIMPLEX CLIP ON

INSTRUCTIONS • INSTRUCTIES • ISTRUZIONI • ANLEITUNG • INSTRUCCIONES • INSTRUÇÕES

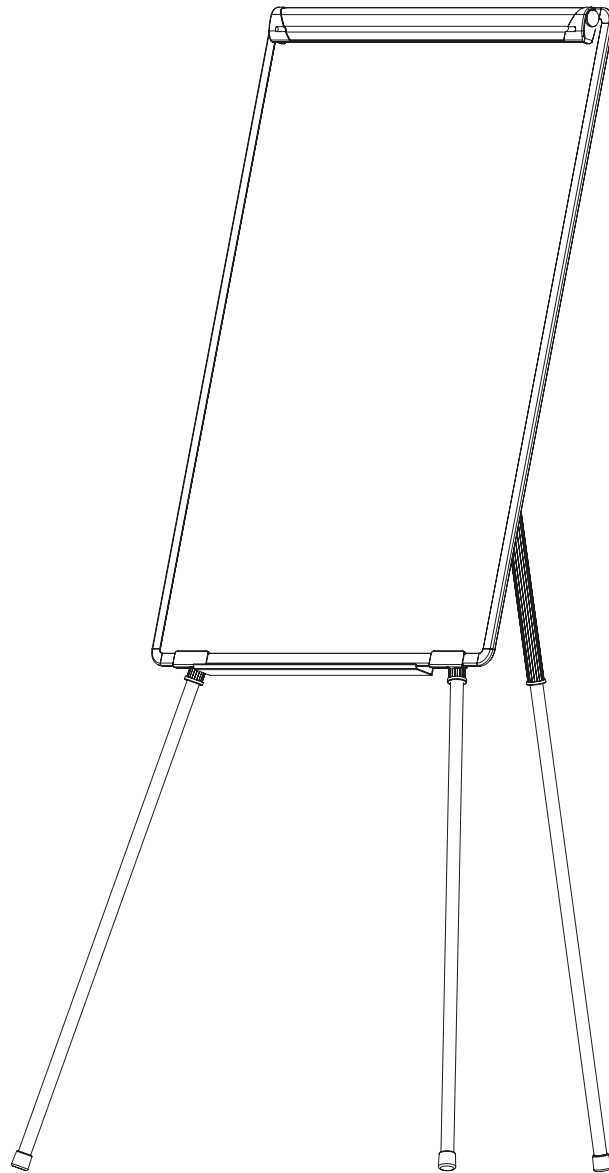

TRIPOD EASEL SIMPLEX CLIP ON

INSTRUCTIONS • INSTRUCTIES • ISTRUZIONI • ANLEITUNG • INSTRUCCIONES • INSTRUÇÕES

NOT INCLUDED

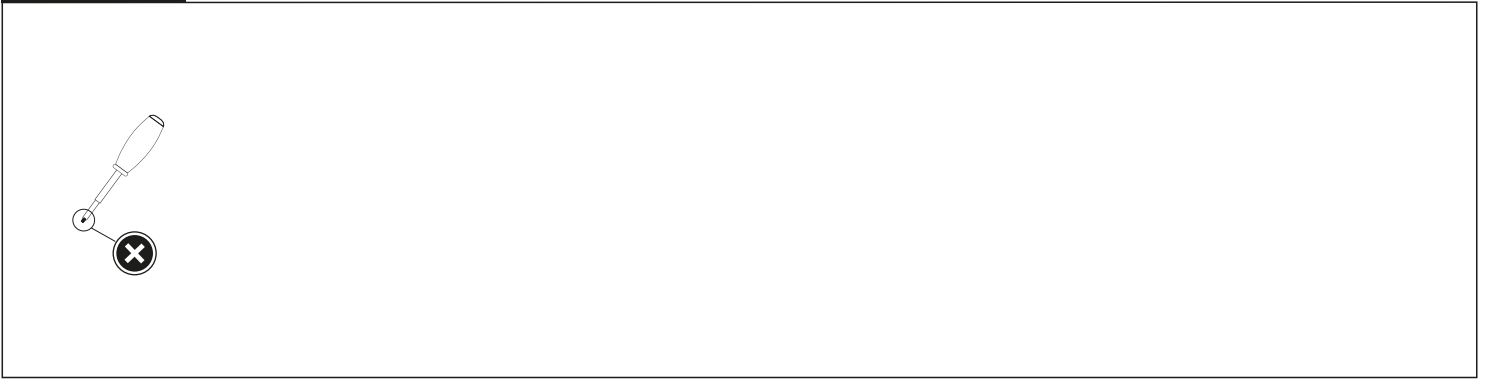

| | | | | | |
|-----------------|-----------------|----------------------|-----------------|-----------------|-----------------|
| A.2x | B.2x | C.2x | D.1x | E.1x | F.2x |
| G.1x | H.1x | I.2x (+1) | J.1x | K.1x | L.1x |
| M.1x | N.1x | O.2x | P.1x | Q.2x | R.2x |
| S.2x | | | | | |

WITH EXTENDABLE ARMS



TRIPOD EASEL SIMPLEX CLIP ON

INSTRUCTIONS • INSTRUCTIES • ISTRUZIONI • ANLEITUNG • INSTRUCCIONES • INSTRUÇÕES

1

2x.A.
2x.B.

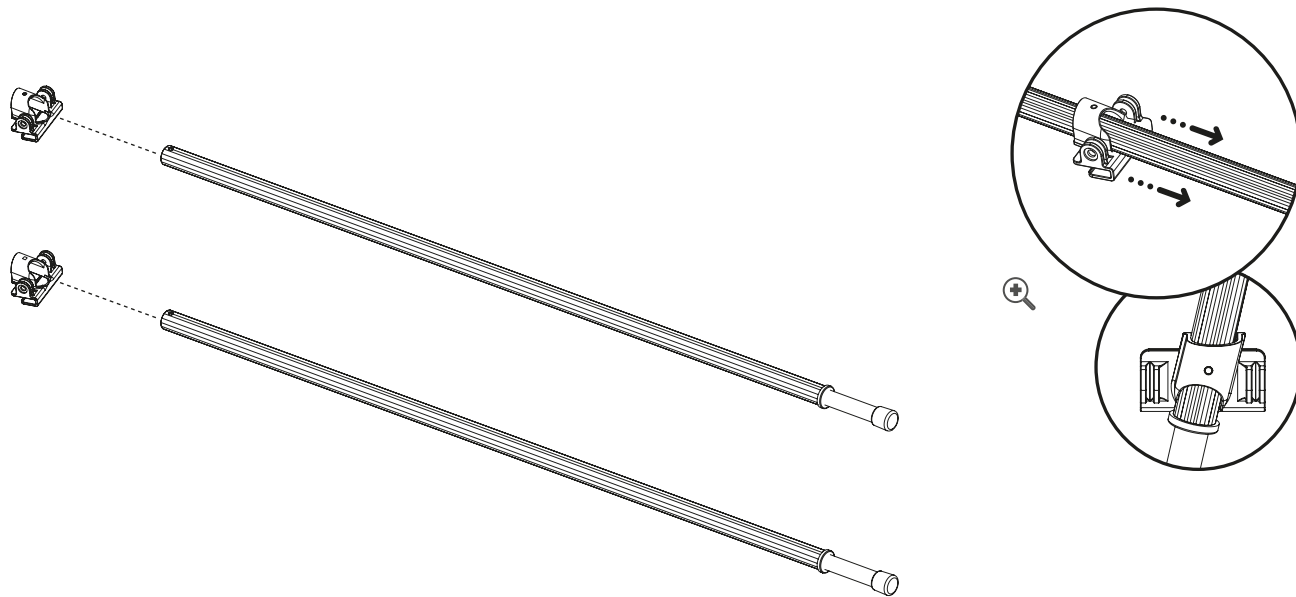

2

2x.C.
1x.D.
1x.E.
2x.F.
1x.G.
1x.H.

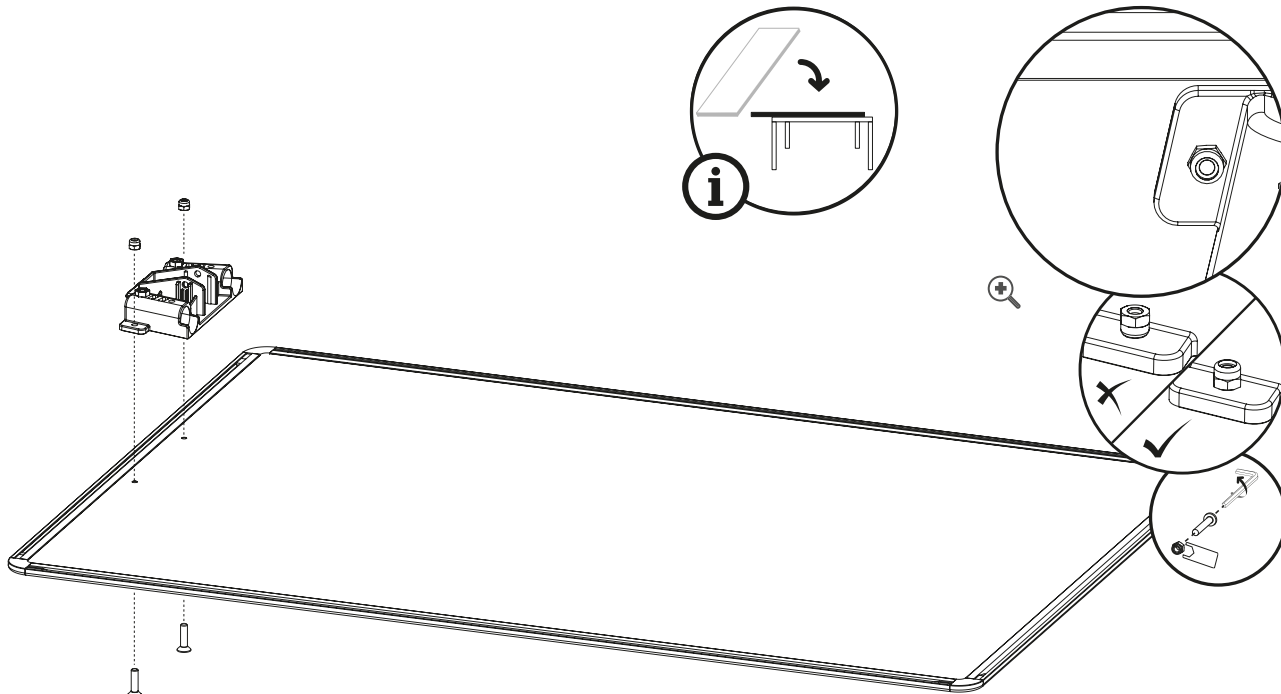

- | | | | | | | | | | |
|-----------------|-----------------|-----------------|-----------------|-----------------|-----------------|-----------------|-----------------|----------------------|-----------------|
| A.2x | B.2x | C.2x | D.1x | E.1x | F.2x | G.1x | H.1x | I.2x (+1) | J.1x |
| K.1x | L.1x | M.1x | N.1x | O.2x | P.1x | Q.2x | R.2x | S.2x | |

1001380290810_REV03



WITH EXTENSIBLE ARMS

TRIPOD EASEL SIMPLEX CLIP ON

INSTRUCTIONS • INSTRUCTIES • ISTRUZIONI • ANLEITUNG • INSTRUCCIONES • INSTRUÇÕES



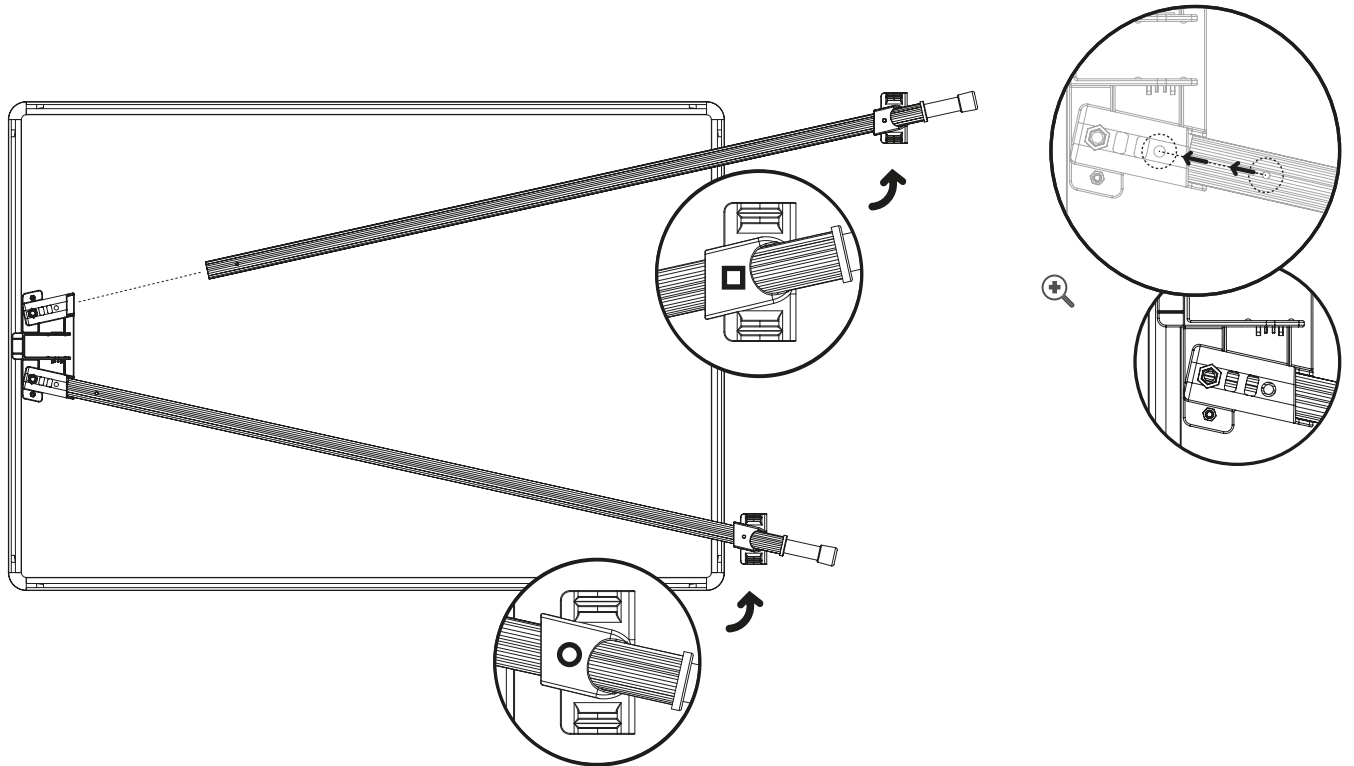





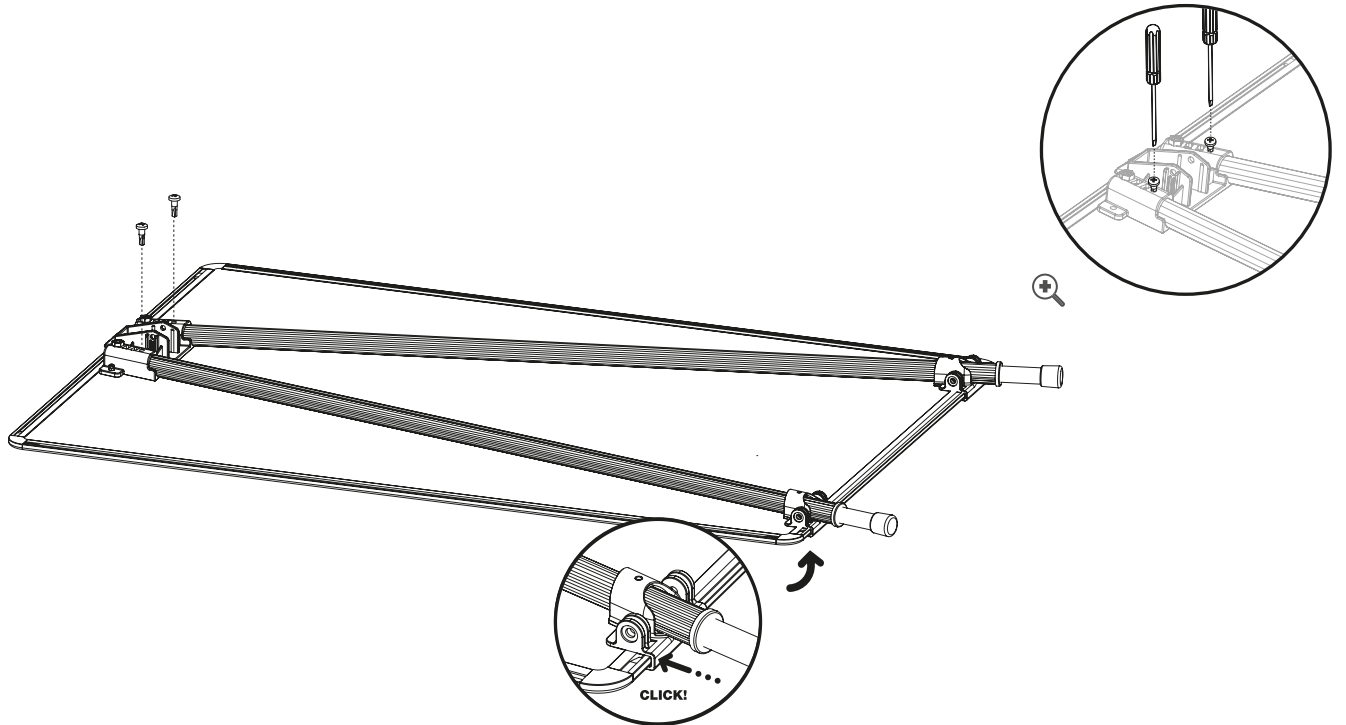









3



4

2x.



- | | | | | | | | | | |
|---|--|--|--|--|--|--|--|---|--|
| A.2x  | B.2x  | C.2x  | D.1x  | E.1x  | F.2x  | G.1x  | H.1x  | I.2x (+1)  | J.1x  |
| K.1x  | L.1x  | M.1x  | N.1x  | O.2x  | P.1x  | Q.2x  | R.2x  | S.2x  | |

WITH EXTENSIBLE ARMS

1001380290810_REV03



TRIPOD EASEL SIMPLEX CLIP ON

INSTRUCTIONS • INSTRUCTIES • ISTRUZIONI • ANLEITUNG • INSTRUCCIONES • INSTRUÇÕES

5



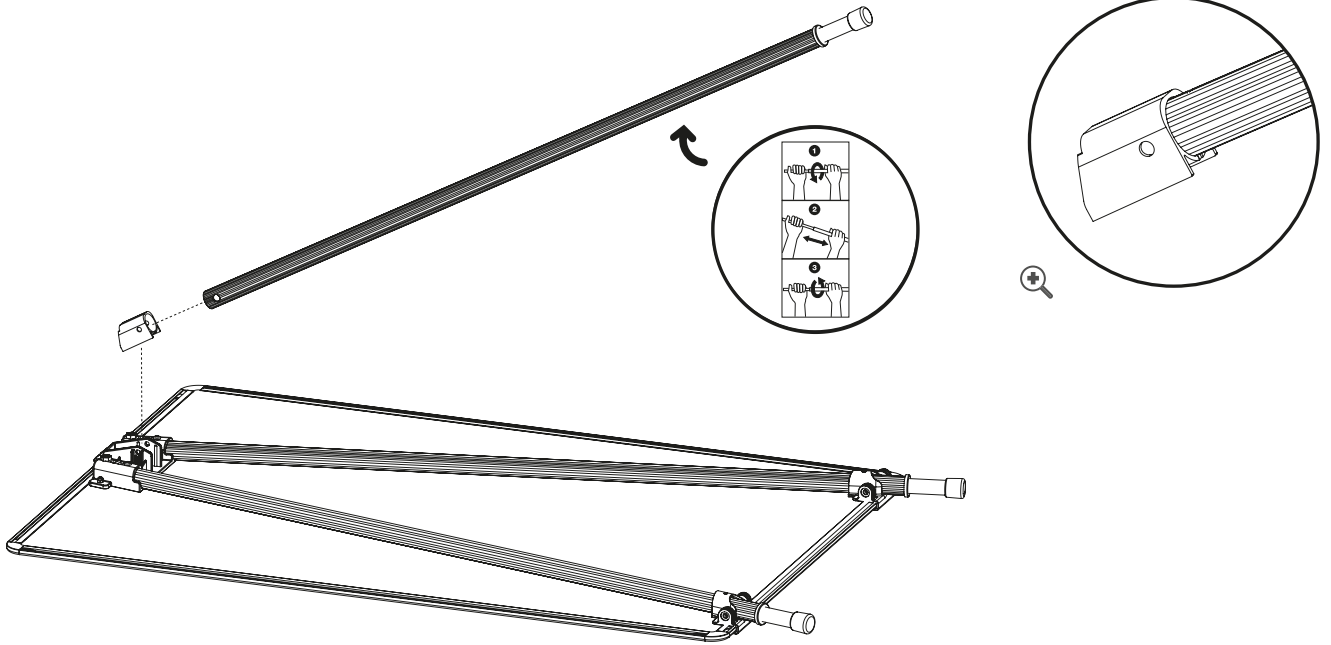





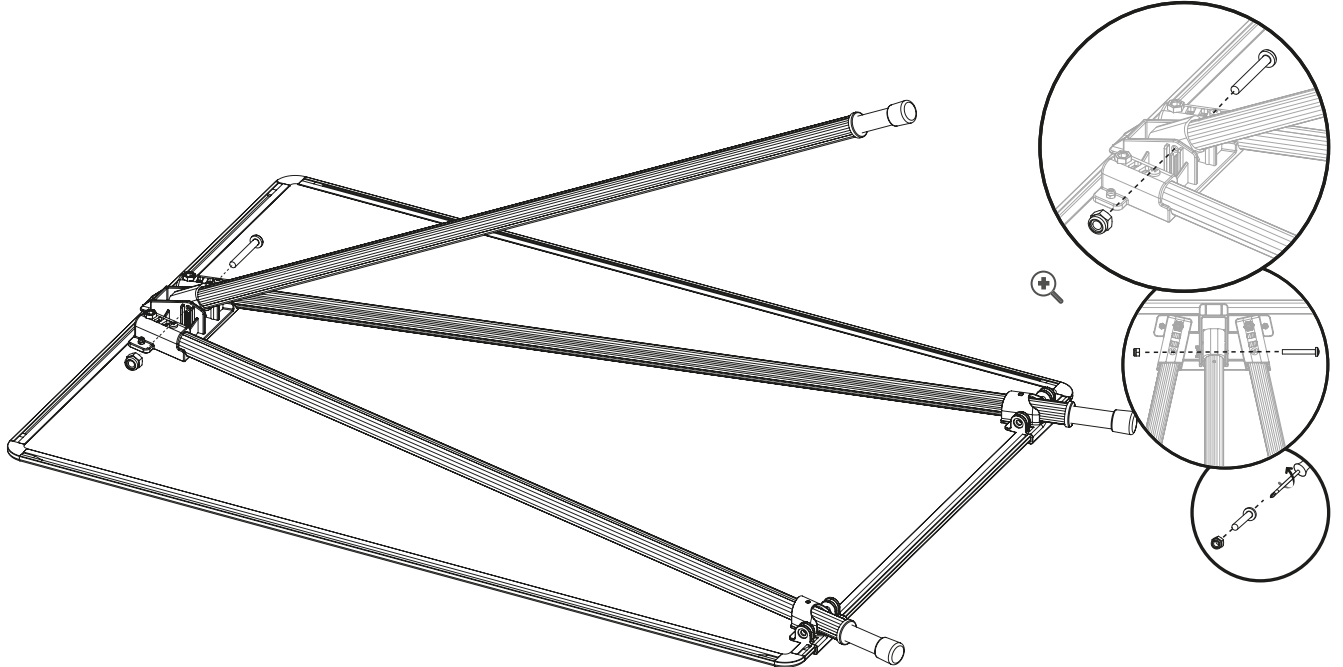









1xJ.
1xK.



6

1xL.
1xM.



- | | | | | | | | | | |
|---|--|--|--|--|--|--|--|---|--|
| A.2x  | B.2x  | C.2x  | D.1x  | E.1x  | F.2x  | G.1x  | H.1x  | I.2x (+1)  | J.1x  |
| K.1x  | L.1x  | M.1x  | N.1x  | O.2x  | P.1x  | Q.2x  | R.2x  | S.2x  | |

WITH EXTENSIBLE ARMS

1001380290810_REV03



TRIPOD EASEL SIMPLEX CLIP ON

INSTRUCTIONS • INSTRUCTIES • ISTRUZIONI • ANLEITUNG • INSTRUCCIONES • INSTRUÇÕES

7
1x.N.

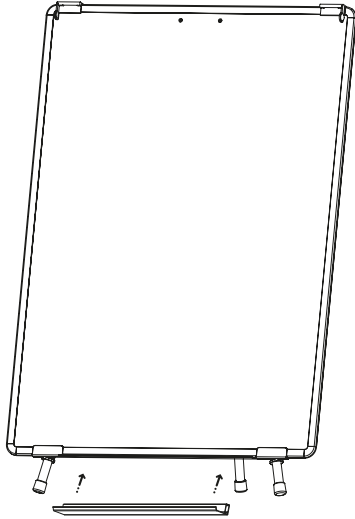
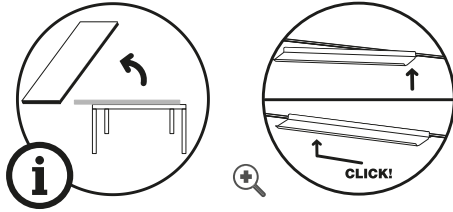





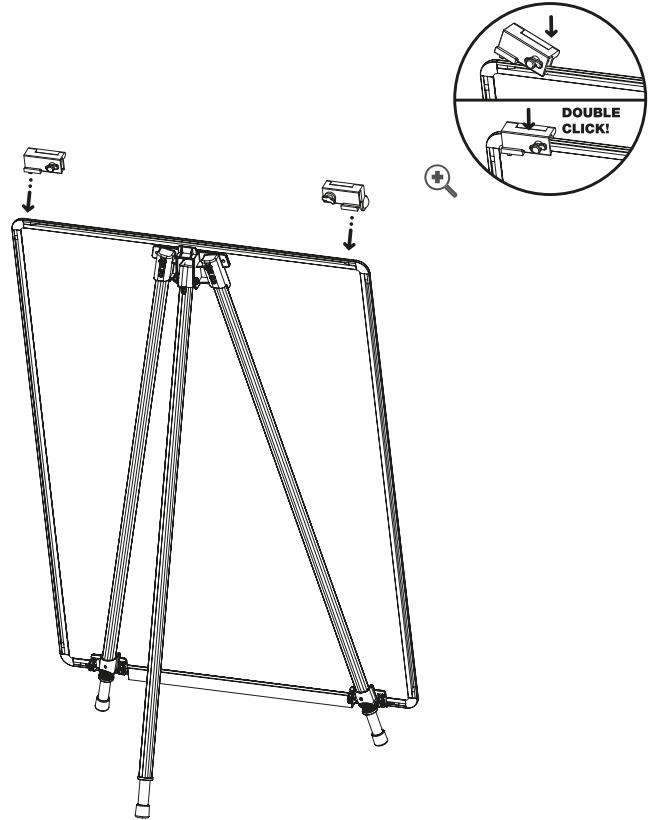



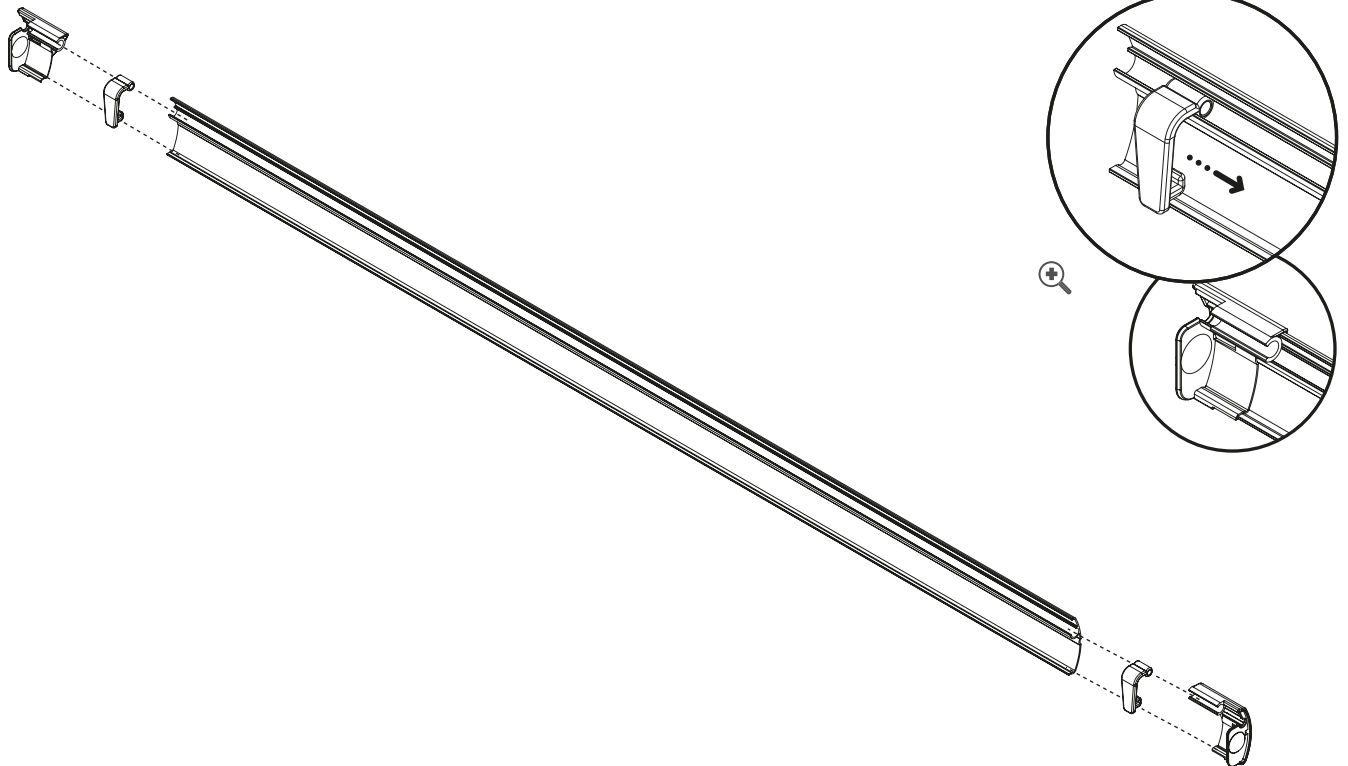











8
2x.O.

WITHOUT EXTENDABLE ARMS



9
1x.P.
2x.Q.
2x.R.



- | | | | | | | | | | |
|---|--|--|--|--|--|--|--|---|--|
| A.2x  | B.2x  | C.2x  | D.1x  | E.1x  | F.2x  | G.1x  | H.1x  | I.2x (+1)  | J.1x  |
| K.1x  | L.1x  | M.1x  | N.1x  | O.2x  | P.1x  | Q.2x  | R.2x  | WITH EXTENSIBLE ARMS | |
| | | | | | | | | S.2x  | |

1001380290810_REV03



TRIPOD EASEL SIMPLEX CLIP ON

INSTRUCTIONS • INSTRUCTIES • ISTRUZIONI • ANLEITUNG • INSTRUCCIONES • INSTRUÇÕES

10

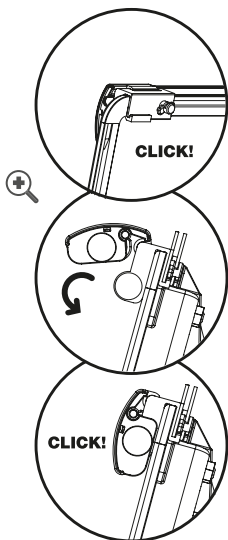
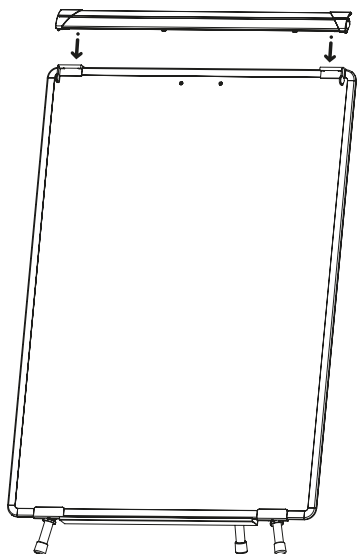

11

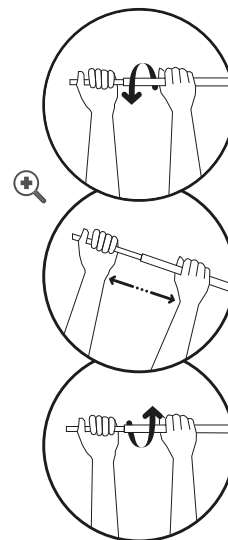
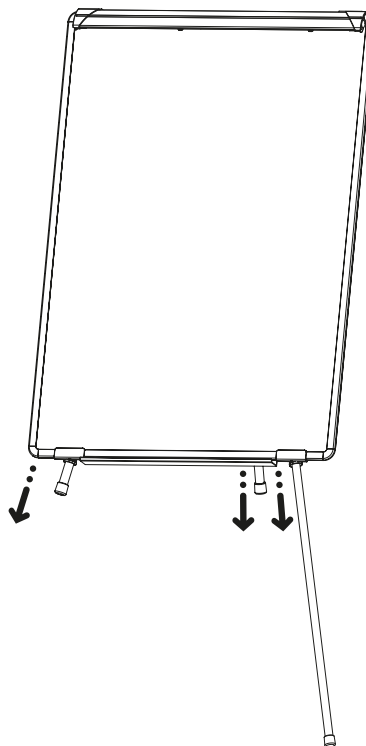

WITH EXTENDABLE ARMS





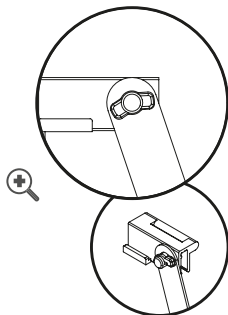
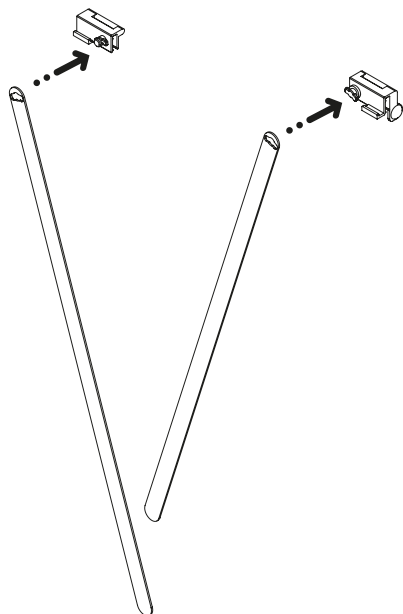



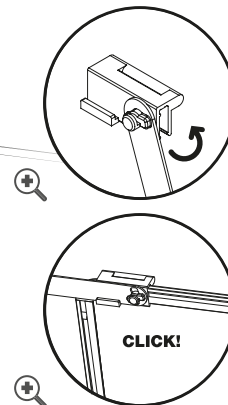
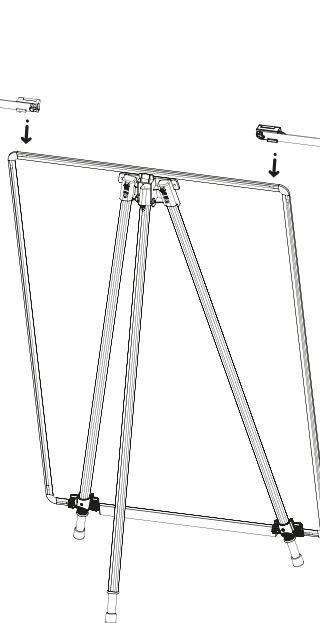









8

2xO.
2xS.



9



- | | | | | | | | | | |
|---|--|--|--|--|--|--|--|---|--|
| A.2x  | B.2x  | C.2x  | D.1x  | E.1x  | F.2x  | G.1x  | H.1x  | I.2x (+1)  | J.1x  |
| K.1x  | L.1x  | M.1x  | N.1x  | O.2x  | P.1x  | Q.2x  | R.2x  | S.2x  | |

WITH EXTENSIBLE ARMS

1001380290810_REV03



TRIPOD EASEL SIMPLEX CLIP ON

INSTRUCTIONS • INSTRUCTIES • ISTRUZIONI • ANLEITUNG • INSTRUCCIONES • INSTRUÇÕES

10

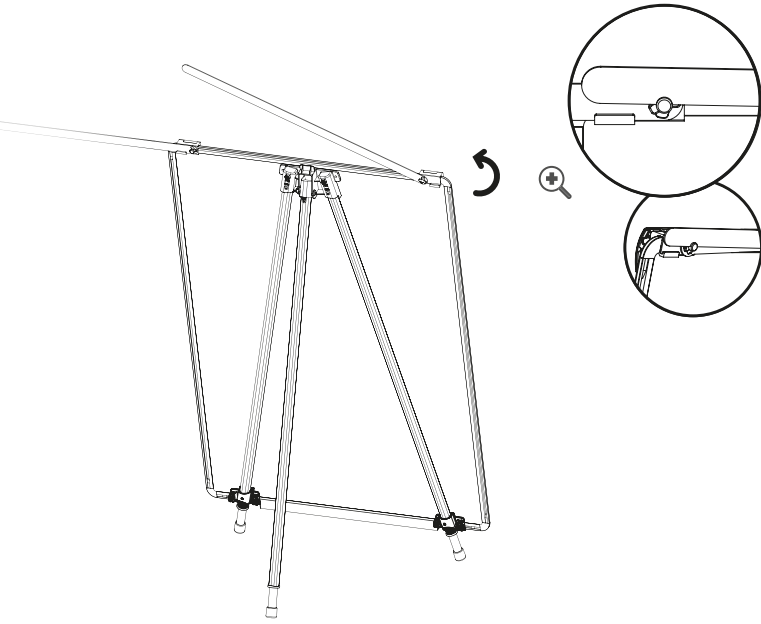

11

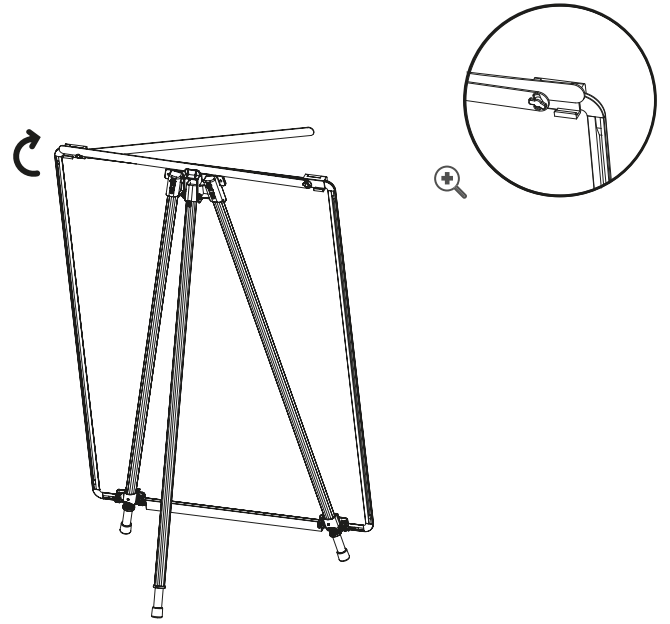

12

1x.P.
2x.Q.
2x.R.

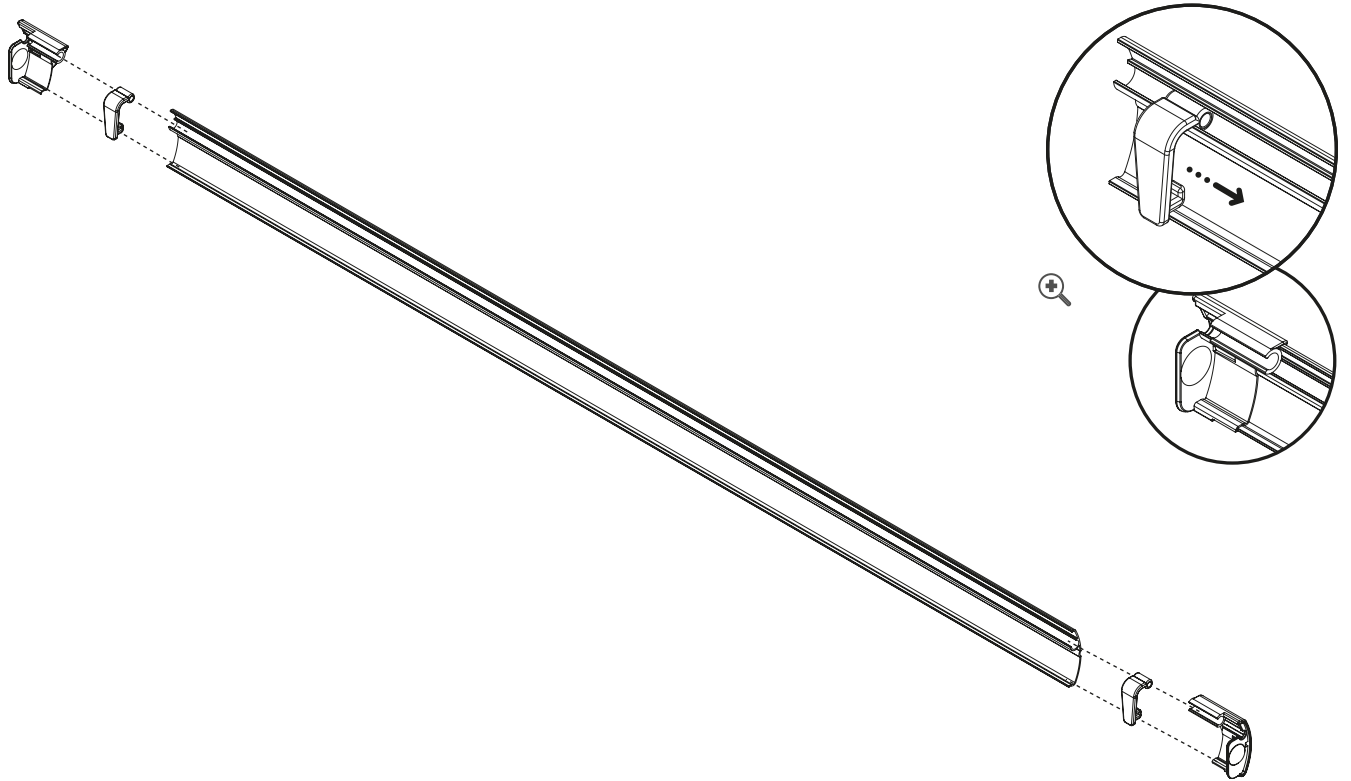

| | | | | | | | | | |
|-----------------|-----------------|-----------------|-----------------|-----------------|-----------------|-----------------|-----------------|----------------------|-----------------|
| A.2x | B.2x | C.2x | D.1x | E.1x | F.2x | G.1x | H.1x | I.2x (+1) | J.1x |
| K.1x | L.1x | M.1x | N.1x | O.2x | P.1x | Q.2x | R.2x | S.2x | |

WITH EXTENSIBLE ARMS

1001380290810_REV03



TRIPOD EASEL SIMPLEX CLIP ON





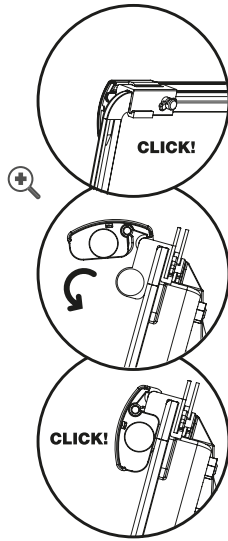
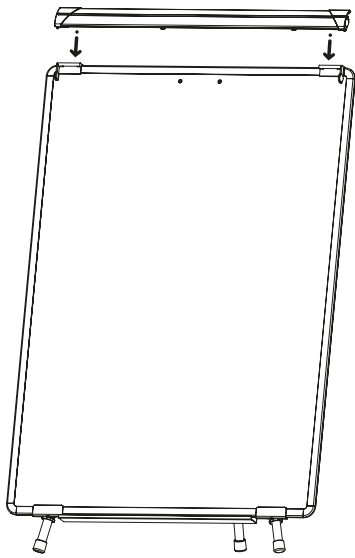



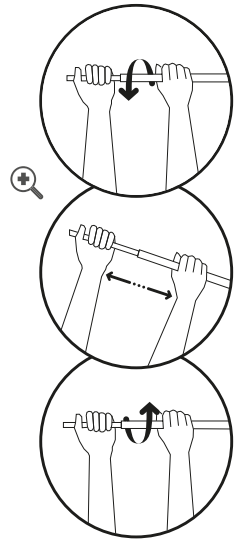
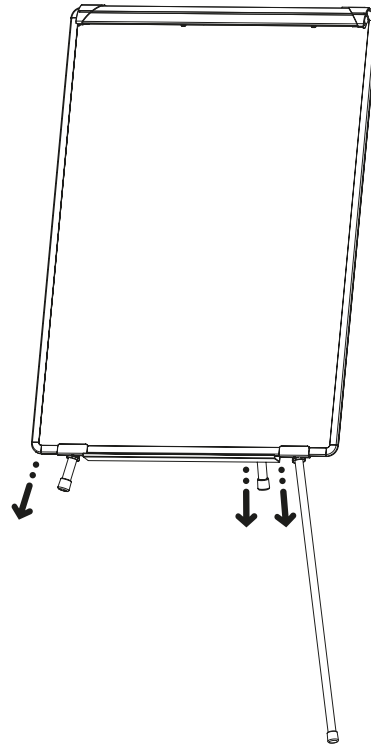









INSTRUCTIONS • INSTRUCTIES • ISTRUZIONI • ANLEITUNG • INSTRUCCIONES • INSTRUÇÕES

13



14



- | | | | | | | | | | |
|---|--|--|--|--|--|--|--|---|--|
| A.2x  | B.2x  | C.2x  | D.1x  | E.1x  | F.2x  | G.1x  | H.1x  | I.2x (+1)  | J.1x  |
| K.1x  | L.1x  | M.1x  | N.1x  | O.2x  | P.1x  | Q.2x  | R.2x  | S.2x  | |

WITH EXTENSIBLE ARMS

1001380290810_REV03

