

A large, stylized graphic of a gear or sunburst with several segments in shades of grey, white, and orange. The logo text is overlaid on this graphic.

**SPACERIGHT**  
europe ltd

## Sales Meeting

- \* Sales Figures
- \* Business Development
- \* Actions Required
- \* AOB

Display & Furniture Solutions  
2020/21

# About Us



Spaceright Europe Ltd is the UK's leading manufacturer of display and presentation products, dining solutions, early years furniture and storage.

We are the manufacturer and supplier of numerous trusted brands, and our products can be found in schools, nurseries and offices across the UK. Innovation, quality, service and design are at the forefront of everything we do and drive the continuing success of our business.

**SPACERIGHT**  
europe ltd

## Innovation

As the leading manufacturer in our field, we are dedicated to investing in new product development and technological efficiencies, to enable us to successfully deliver cutting edge solutions for our customers.

## Quality

We are committed to using the best quality materials and most skilled craftsmen to ensure we supply products which are manufactured to a high standard, making them durable, safe and reliable, whilst also representing excellent value.

## Service

Customer service is pivotal to our success and we strive to provide the very best expert advice, helpful product information and after sales support, as well as competitive pricing, quick lead times and a reliable delivery service.

## Design

Our history goes back over 100 years, meaning that our product knowledge and market insight is unparalleled, so when it comes to designing products and space planning, we are experts in our field.



# Contents

- 5 Dining Furniture
- 32 Writing Boards
- 55 Flip Chart Easels
- 61 WeatherShield Showcases & Signage
- 71 Fire Retardant Noticeboards
- 81 Noticeboards
- 97 Display & Presentation
- 109 Exhibition & Display Screens
- 121 Classroom Furniture & Storage





# Information

## Icon Guide

Fire Retardant	Accepts Pins	Weatherproof	Assembly Required	Magnetic	Lockable	Fully Assembled
Easy Clean	Dry Wipe	Revolves Horizontally	Revolves Vertically	Made in UK	Height Adjustable	Width Adjustable
5 Day Lead Time	2 Week Lead Time	4 Week Lead Time	3D Room Planning	1 Year Guarantee	2 Year Guarantee	
3 Year Guarantee	5 Year Guarantee	10 Year Guarantee	16 Year Guarantee	25 Year Guarantee	Lifetime Surface Guarantee	

## Ordering

Orders can be placed online, by email or fax. All orders are subject to our standard terms and conditions, a copy of which is available online or upon request. Prices are shown exclusive of VAT which will be applied at the current rate. Payment terms are 30 days net from invoice or proforma.

## Delivery

Product lead times are indicated throughout the catalogue. As a general rule most products are available within 5-10 working days, with the exception of our dining furniture and personalised items, which are delivered within 4 weeks. Delivery is free on orders over £99.00 (exl. VAT). For orders under £99.00 (exl. VAT) a £5.80 (exl. VAT) delivery charge will apply upto 20kg (additional charge for more than 20kgs). For Highlands and Islands, Channel Islands, Isle of Man and Northern Ireland, a surcharge will apply. All mobile dining furniture is delivered by our own transport (ground floor only).

## Guarantees

All of our products come with a guarantee, which represents our commitment to both quality and service. Our mobile dining tables have a 16 year guarantee (on table mechanism and welds), whilst some of our writing boards benefit from a surface guarantee of up to 25 years.

## Assembly

Our range includes fully assembled and self assemble products which are identified throughout the catalogue. Where a product is self-assemble, all the instructions, screws and other fixings, are in the box. In most cases we even supply the tools to do the job.

## Accreditations

Spaceright Europe Ltd, a member of British Educational Supplies Association (BESA), has approved quality management, health/safety management, and environmental management systems in place, giving us the following accreditations: ISO 9001:2008 ISO 14001:2008

## 3D Survey & Space Planning

We offer a completely free and comprehensive site survey and space planning service for our dining furniture range. So whether you have a detailed vision of what you want or need inspiration, we can provide a solution which is right for you. Please see page 31.

All sizes stated are external board measurements unless otherwise noted e.g. poster cases. Colours as shown in the catalogue may vary from the actual colours due to photography and printing process. Full terms and conditions are available on request or via our web site. Spaceright Europe Ltd operate a policy of continuous improvement, therefore we reserve the right to alter the design or specification of a product without notice. Spaceright Europe Ltd claim their right as publishers of the copyright to this catalogue, therefore no content may be reproduced without written consent. E and O E.



# Dining Furniture

Our flexible dining solutions enable schools to convert halls into multi-use areas effortlessly, without the need for heavy lifting.

In designing our range, we used our expert knowledge of schools and similar environments, to deliver a comprehensive range of dining solutions, which represent the very best in quality, versatility and value.

Our dining products benefit from the following:

- High quality manufacturing
- Choice of heights and designs
- Product guarantee
- Free site survey
- Free 3D space planning

## Dining Furniture Contents

	Page
Cube Tables and Benches	06-07
Fast Fold Tables and Benches	08-13
Primo Folding Tables	14-17
Mobile Folding Tables	18-25
Bench Units	26-29



# Dining Furniture

## Cube Table & Benches

Stylish and modern in design, the Cube table and bench range is the ideal solution for secondary, higher and further education establishments.

- Modern table and bench design
- Benches can be stored neatly underneath the table for space efficient storage
- Durable, sturdy construction with easy clean surface
- 50mm thick laminated table top
- White powder coated steel frame
- Choice of 2 top colours
- 5 year guarantee



**NEW**

Cube Table	Code
767(h) x 1510(w) x 610mm (d)	9SCTWHITE
767(h) x 1510(w) x 610mm (d)	9SCTOAK

**NEW**

Cube Bench Set (includes 2 x benches)	Code
430(h) x 1390(w) x 305mm (d)	9SCBWHITE
430(h) x 1390(w) x 305mm (d)	9SCBOAK

**NEW**

Cube Set (1 x table, 2 x benches)	Code
Set (Table and 2 x benches)	9SCSWHITE
Set (Table and 2 x benches)	9SCSOAK

### Colour Options



White Gloss  
9001



Moderno Oak  
9003

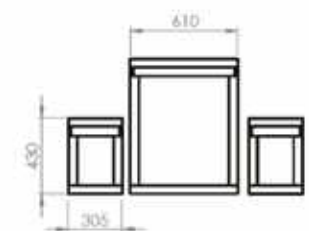
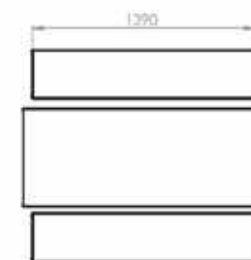
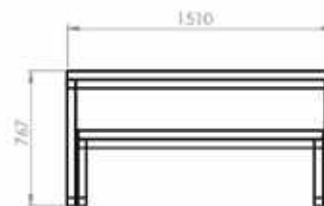

## Modern

With a 50mm thick table top and square shaped frame, the Cube table and bench range will bring a modern feel and fresh look to your dining area.



# Dining Furniture

## Fast Fold Rectangular Table and Benches

Slimline, space saving tables and benches with a unique folding mechanism, which allows the legs to fold neatly into the thinnest (40mm) frame on the market.

Exceptionally efficient storage with 10 tables and 20 benches requiring only 0.7m<sup>2</sup> of space when stored on the trolley.

- Rectangular tables and benches for everyday use
- Lightweight aluminium frame design with steel legs for strength and stability
- Both table and bench legs fold for efficient storage
- Ideal for schools, clubs and similar environments
- Choice of 6 table and bench colours
- 5 year warranty



Fast Fold Table 1220mm(L) x 610mm(W)	Code
460mm(h)	FFR4H0W1
530mm(h)	FFR4H1W1
635mm(h)	FFR4H2W1
710mm(h)	FFR4H3W1

Fast Fold Table 1220mm(L) x 685mm(W)	Code
460mm(h)	FFR4H0W2
530mm(h)	FFR4H1W2
635mm(h)	FFR4H2W2
710mm(h)	FFR4H3W2

Folding Bench 1220mm(L) x 305mm(W)	Code
260mm(h)	FFB4H0
330mm(h)	FFB4H1
375mm(h)	FFB4H2
450mm(h)	FFB4H3

Fast Fold Table 1525mm(L) x 610mm(W)	Code
460mm(h)	FFR5H0W1
530mm(h)	FFR5H1W1
635mm(h)	FFR5H2W1
710mm(h)	FFR5H3W1

Fast Fold Table 1525mm(L) x 685mm(W)	Code
460mm(h)	FFR5H0W2
530mm(h)	FFR5H1W2
635mm(h)	FFR5H2W2
710mm(h)	FFR5H3W2

Folding Bench 1525mm(L) x 305mm(W)	Code
260mm(h)	FFB5H0
330mm(h)	FFB5H1
375mm(h)	FFB5H2
450mm(h)	FFB5H3

Fast Fold Table 1830mm(L) x 610mm(W)	Code
460mm(h)	FFR6H0W1
530mm(h)	FFR6H1W1
635mm(h)	FFR6H2W1
710mm(h)	FFR6H3W1

Fast Fold Table 1830mm(L) x 685mm(W)	Code
460mm(h)	FFR6H0W2
530mm(h)	FFR6H1W2
635mm(h)	FFR6H2W2
710mm(h)	FFR6H3W2

Folding Bench 1830mm(L) x 305mm(W)	Code
260mm(h)	FFB6H0
330mm(h)	FFB6H1
375mm(h)	FFB6H2
450mm(h)	FFB6H3

### Colour Options



Patent No. 2560852B





### Lightweight

Designed for simplicity of use, the fast fold tables and benches are lightweight but sturdy, with an aluminium frame and steel legs for strength and stability. Thinnest (40mm) folding tables and benches on the market.

# Dining Furniture

## Fast Fold Trolley sets

Slimline, space saving table and bench sets supplied with a heavy duty steel trolley for efficient storage. Choose from the following sets: 10 tables plus 20 benches, 20 tables or 40 benches.

- Tables and benches have a unique folding mechanism, which allows the legs to fold neatly into the thinnest (40mm) frame on the market
- Each trolley set requires only 0.7m<sup>2</sup> of storage space
- Trolley is designed to easily fit through doors and has heavy duty locking castors
- Choice of 6 table and bench colours
- 5 year warranty



Trolley with 10 tables and 20 benches	Code
Table and bench length: 1220mm x Table width: 610mm / Bench width: 305mm	
Table Height: 530mm / Bench Height: 330mm	FFBUN2L4H1W1
Table Height: 635mm / Bench Height: 375mm	FFBUN2L4H2W1
Table Height: 710mm / Bench Height: 450mm	FFBUN2L4H3W1
<b>Table and bench length: 1220mm x Table width: 685mm / Bench width: 305mm</b>	
Table Height: 530mm / Bench Height: 330mm	FFBUN2L4H1W2
Table Height: 635mm / Bench Height: 375mm	FFBUN2L4H2W2
Table Height: 710mm / Bench Height: 450mm	FFBUN2L4H3W2
<b>Table and bench length: 1830mm x Table width: 610mm / Bench width: 305mm</b>	
Table Height: 530mm / Bench Height: 330mm	FFBUN2L6H1W1
Table Height: 635mm / Bench Height: 375mm	FFBUN2L6H2W1
Table Height: 710mm / Bench Height: 450mm	FFBUN2L6H3W1
<b>Table and bench length: 1830mm x Table width: 685mm / Bench width: 305mm</b>	
Table Height: 530mm / Bench Height: 330mm	FFBUN2L6H1W2
Table Height: 635mm / Bench Height: 375mm	FFBUN2L6H2W2
Table Height: 710mm / Bench Height: 450mm	FFBUN2L6H3W2

Trolley with 20 tables	Code
Table length: 1220mm x Table width: 610mm	
Table Height: 530mm	FFBUN1L4H1W1
Table Height: 635mm	FFBUN1L4H2W1
Table Height: 710mm	FFBUN1L4H3W1
<b>Table length: 1220mm x Table width: 685mm</b>	
Table Height: 530mm	FFBUN1L4H1W2
Table Height: 635mm	FFBUN1L4H2W2
Table Height: 710mm	FFBUN1L4H3W2
<b>Table length: 1830mm x Table width: 610mm</b>	
Table Height: 530mm	FFBUN1L6H1W1
Table Height: 635mm	FFBUN1L6H2W1
Table Height: 710mm	FFBUN1L6H3W1
<b>Table length: 1830mm x Table width: 685mm</b>	
Table Height: 530mm	FFBUN1L6H1W2
Table Height: 635mm	FFBUN1L6H2W2
Table Height: 710mm	FFBUN1L6H3W2

Trolley with 40 benches	Code
Bench length: 1220mm x Bench width: 305mm	
Bench Height: 330mm	FFBUN3L4H1
Bench Height: 375mm	FFBUN3L4H2
Bench Height: 450mm	FFBUN3L4H3
<b>Bench length: 1830mm x Bench width: 305mm</b>	
Bench Height: 330mm	FFBUN3L6H1
Bench Height: 375mm	FFBUN3L6H2
Bench Height: 450mm	FFBUN3L6H3



### Colour Options

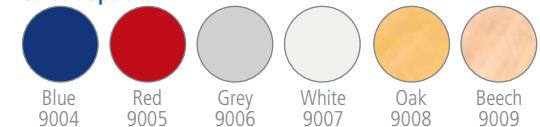

Patent No. 2560852B

### Fast Fold Rectangular Table and Bench Trolley

Designed to accommodate the Fast Fold rectangular tables and benches for transportation and storage. Unique design of tables and benches allows trolley to hold more tables and benches than any other on the market.

- Holds up-to 20 tables, 40 benches, or 10 tables with 20 benches
- Heavy duty single piece steel structure
- Strong locking castors
- Designed to easily fit through doors



Rectangular Table and Bench Trolley

Code

920(w) x 1125(h) x 760mm(d)

FFTROY



This holds  
all of this



# Dining Furniture

## Fast Fold Round Table

- Table legs fold into the frame allowing you to store more tables into the same area or trolley
- Round tables for everyday use
- Ideal for schools, clubs and similar environments
- Sturdy but lightweight design
- Strong aluminium framed edging
- Steel legs for stability
- 6 colours to choose from
- 5 year warranty



Fast Fold Round Table	Code
530(h) x 1200mm (dia)	FFCH1
635(h) x 1200mm (dia)	FFCH2
710(h) x 1200mm (dia)	FFCH3

## Colour Options



## Fast Fold Round Table Trolley

- Designed to accommodate the Fast Fold round table
- Once tables are in folded position, trolley holds up to 12 tables
- Tables stack upright as shown
- Tables are held in place with Velcro straps for safety
- Made from steel with locking castors



Round Fast Fold Table Trolley	Code
1504(w) x 900(h) x 740mm (d)	FFTROLLEYR



Patent No. 2560852B

### Multipurpose

Fast fold round tables can be used for a variety of different functions, whether its for dining, teaching or school events, you will find these tables hassle free, quick and easy to use.



# Dining Furniture

## 8 Seat Primo Round Mobile Folding Table

- Contemporary dining table with gloss or oak effect table top
- Designed for use in secondary, higher and further education establishments
- 50mm thick laminated table top and grey frame
- Fits through standard height doorway (1980mm) for storage and transportation
- Open position safety lock (to ensure table does not revert to folding position)
- Easy-clean intermediate lock for improved hygiene
- Transport and storage locking positions
- 3 seat options to choose from
- Adult height 767mm
- Heavy duty locking castors
- 3 modern table top options to choose from
- 16 year warranty on welds and mechanism



Moderno Oak Primo Mobile Folding Table		Code
767(h) x 2155mm (d)	Stool	9SRL60830PR03S
767(h) x 2155mm (d)	Seat	9SRL60830PR03
767(h) x 2155mm (d)	Full Back	9SRL60830PR03FB



White Gloss Primo Mobile Folding Table		Code
767(h) x 2155mm (d)	Stool	9SRL60830PR02S
767(h) x 2155mm (d)	Seat	9SRL60830PR02
767(h) x 2155mm (d)	Full Back	9SRL60830PR02FB



Watch the video

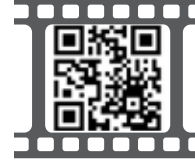

Scan the QR code



Black Gloss Primo Mobile Folding Table		Code
767(h) x 2155mm (d)	Stool	9SRL60830PR01S
767(h) x 2155mm (d)	Seat	9SRL60830PR01
767(h) x 2155mm (d)	Full Back	9SRL60830PR01FB

### Colour Options



Primo Folding Round

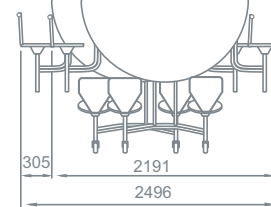
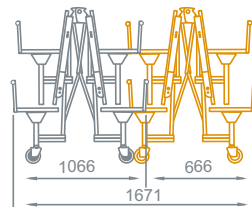
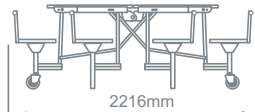
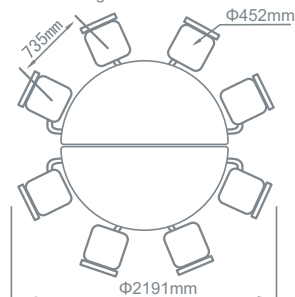

	29
A	767mm
B	435mm
C	1380mm

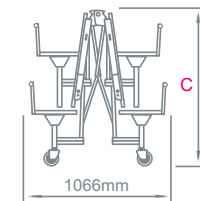
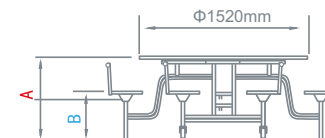

## Contemporary

Primo tables combine all the key features of our standard mobile tables with a contemporary style which is ideal for secondary, higher and further education establishments.



# Dining Furniture

## 12 Seat Primo Rectangular Mobile Folding Table

- Contemporary dining table with gloss or oak effect table top
- Designed for use in secondary, higher and further education establishments
- 50mm thick laminated table top and grey frame
- Fits through standard height doorway (1980mm) for storage and transportation
- Open position safety lock (to ensure table does not revert to folding position)
- Easy-clean intermediate lock for improved hygiene
- Transport and storage locking positions
- 3 seat options to choose from
- Adult height 767mm
- Heavy duty locking castors
- 3 modern table top options to choose from
- 16 year warranty on welds and mechanism

Watch the video



Scan the QR code



Seat Option



Stool Option



Full Back Option



Moderno Oak Primo Mobile Folding Table		Code
767(h) x 3080(w) x 1500mm (d)	Stool	9SRL101230PR03S
767(h) x 3080(w) x 1500mm (d)	Seat	9SRL101230PR03
767(h) x 3080(w) x 1500mm (d)	Full Back	9SRL101230PR03FB

White Gloss Primo Mobile Folding Table		Code
767(h) x 3080(w) x 1500mm (d)	Stool	9SRL101230PR02S
767(h) x 3080(w) x 1500mm (d)	Seat	9SRL101230PR02
767(h) x 3080(w) x 1500mm (d)	Full Back	9SRL101230PR02FB

Black Gloss Primo Mobile Folding Table		Code
767(h) x 3080(w) x 1500mm (d)	Stool	9SRL101230PR01S
767(h) x 3080(w) x 1500mm (d)	Seat	9SRL101230PR01
767(h) x 3080(w) x 1500mm (d)	Full Back	9SRL101230PR01FB

### Colour Options



### Model Rectangular 1012 Primo Table

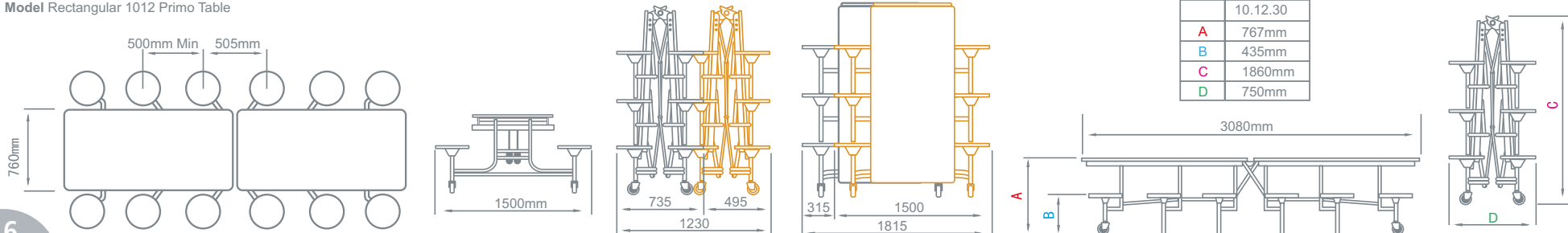



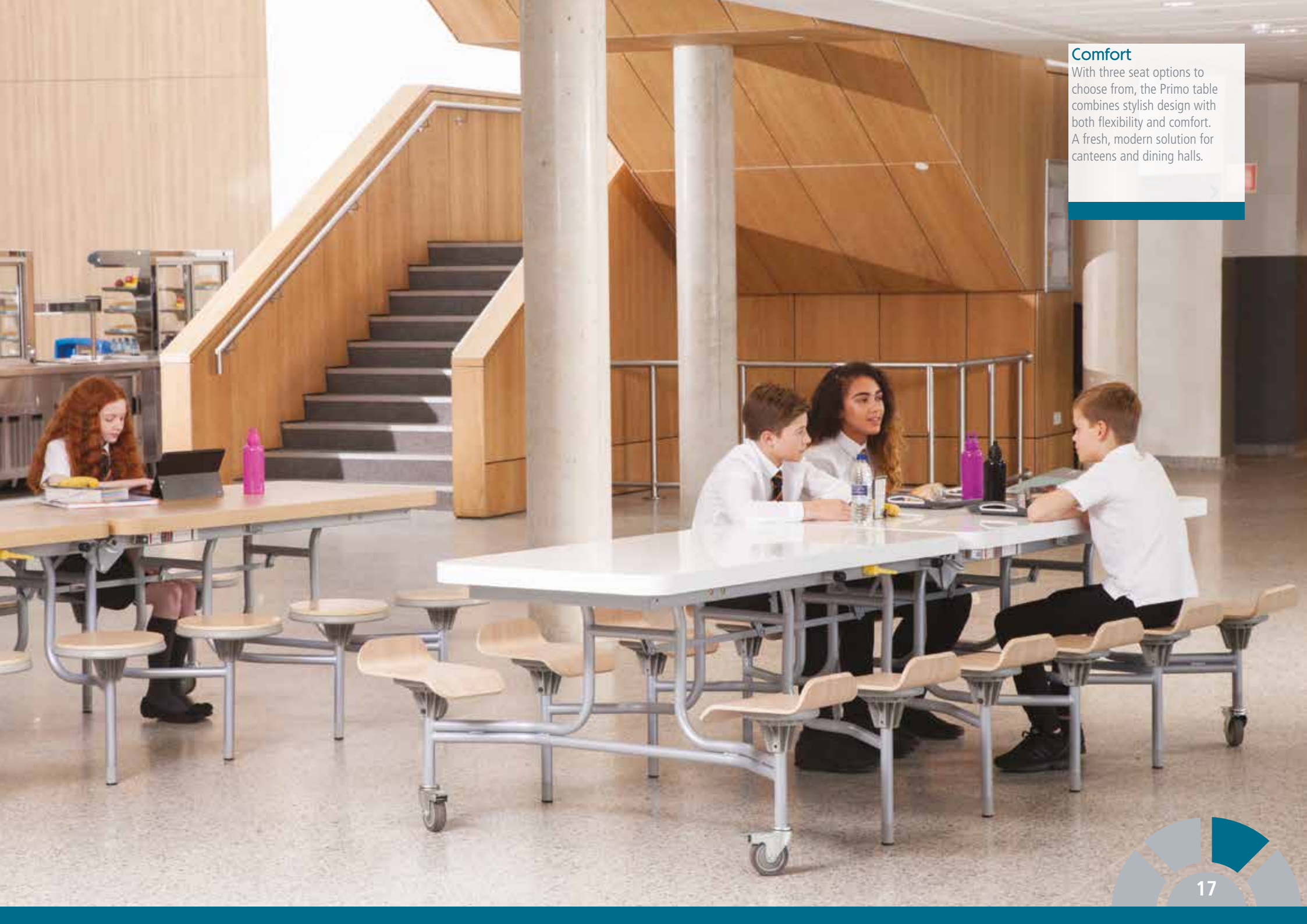

### Comfort

With three seat options to choose from, the Primo table combines stylish design with both flexibility and comfort. A fresh, modern solution for canteens and dining halls.

# Dining Furniture

## 8 Seat Round and Octagonal Mobile Folding Tables

- Mobile folding table with grey frame which is easy to fold, store and clean
- Laminated table top with tough edging and MDF core (water resistant and easy clean)
- Fits through standard height doorway (1980mm) for storage and transportation
- Open position safety lock (to ensure table does not revert to folding position)
- Easy-clean intermediate lock for improved hygiene
- Choice of two heights (primary and secondary)
- 16 year warranty on welds and mechanism
- Heavy duty locking castors
- 11 stool colours to choose from
- FIRA certified



### Round Mobile Folding Table (8 Seat Unit)

### Code

685(h) x 2155mm (d)	95RL60827
735(h) x 2155mm (d)	95RL60829

### Octagonal Mobile Folding Table (8 Seat Unit)

### Code

685(h) x 2155mm (d)	95RLOCT60827
735(h) x 2155mm (d)	95RLOCT60829

### Round Table Top Colour Option

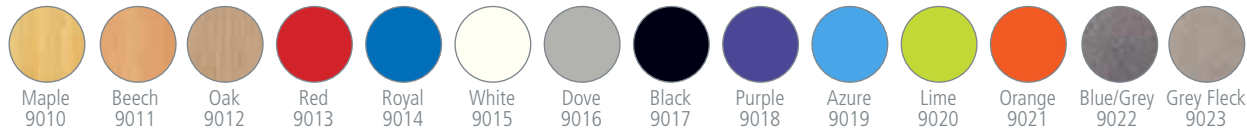

### Octagonal Table Top Colour Options



### Stool Colour Options

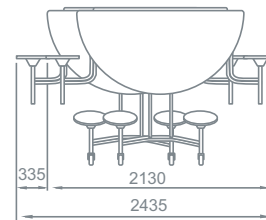
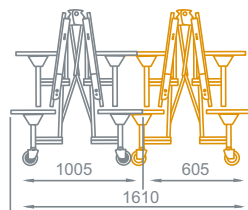
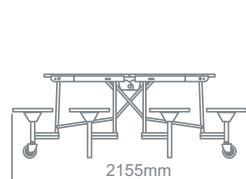
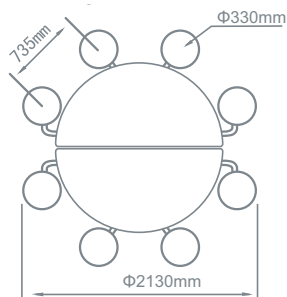

	27	29
A	685mm	735mm
B	375mm	425mm
C	1330mm	1380mm

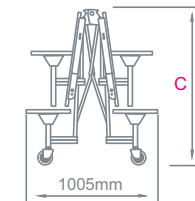
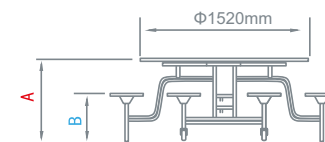



### Effortless

Our mobile folding tables make it quick and effortless to convert multi-use halls into dining areas without the need for heavy lifting. A perfect solution for busy schools and canteens.

# Dining Furniture

## 8 Seat Rectangular Mobile Folding Table

- Mobile folding table with grey frame which is easy to fold, store and clean
- Laminated table top with tough edging and MDF core (water resistant and easy clean)
- Fits through standard height doorway (1980mm) for storage and transportation
- Open position safety lock (to ensure table does not revert to folding position)
- Easy-clean intermediate lock for improved hygiene
- Transport and storage locking positions
- Choice of two heights (primary and secondary)
- 16 year warranty on welds and mechanism
- Heavy duty locking castors
- 14 table top colours to choose from
- 11 stool colours to choose from
- FIRA certified

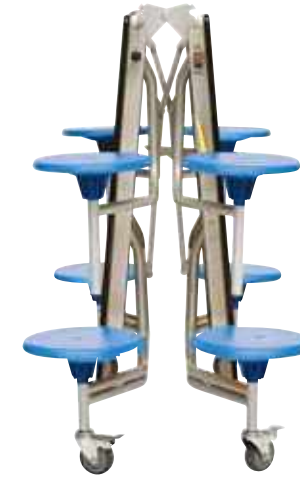

Rectangular Mobile Folding Table (8 Seat Unit)	Code
685(h) x 2380(w) x 1500mm (d)	9SRL80827
735(h) x 2380(w) x 1500mm (d)	9SRL80829

### Table Top Colour Option

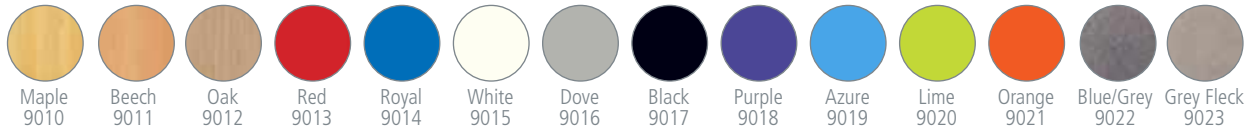

### Stool Colour Options



Model Rectangular 808

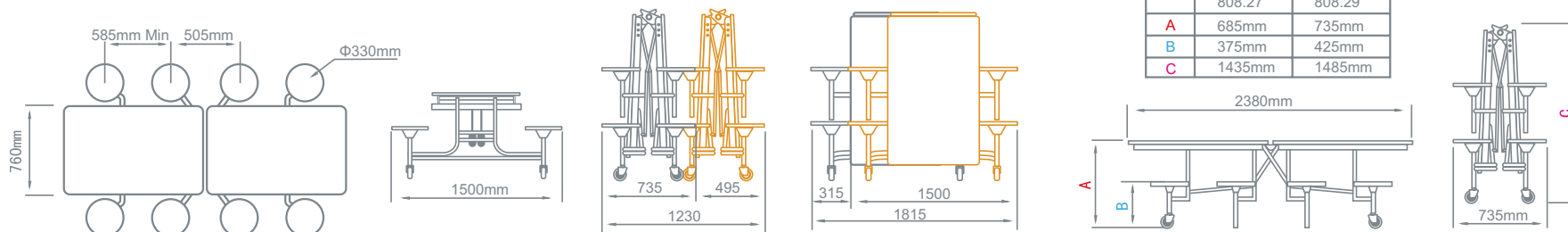



### Hygienic

Safety and cleanliness are important factors in the design of our mobile folding tables. Each has an open position safety lock to ensure the table does not revert to the folding position and an intermediate lock for improved hygiene.

# Dining Furniture

## 12 Seat Rectangular Mobile Folding Table

- Mobile folding table with grey frame which is easy to fold, store and clean
- Laminated table top with tough edging and MDF core (water resistant and easy clean)
- Fits through standard height doorway (1980mm) for storage and transportation
- Open position safety lock (to ensure table does not revert to folding position)
- Easy-clean intermediate lock for improved hygiene
- Transport and storage locking positions
- Choice of two heights (primary and secondary)
- 16 year warranty on welds and mechanism
- Heavy duty locking castors
- 14 table top colours to choose from
- 11 stool colours to choose from
- FIRA certified



Rectangular Mobile Folding Table (12 Seat Unit)

Code

685(h) x 3080(w) x 1500mm (d)

9SRL101227

735(h) x 3080(w) x 1500mm (d)

9SRL101229



### Table Top Colour Option

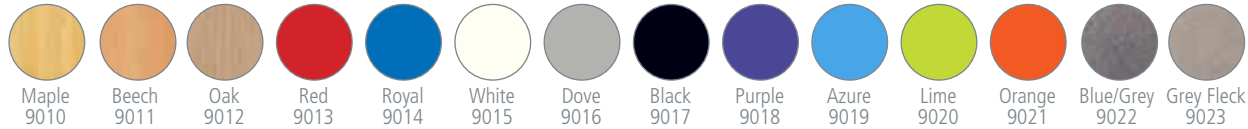

### Stool Colour Options



### Model Rectangular 1012

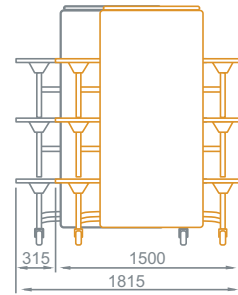
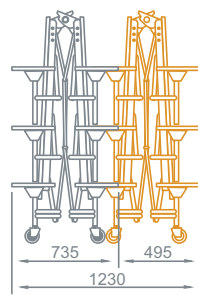
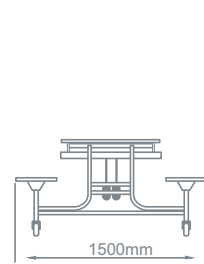
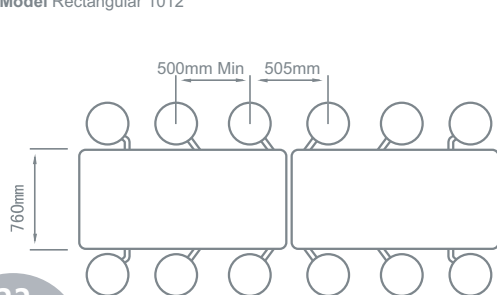

	10.12.27	10.12.29
A	685mm	735mm
B	375mm	425mm
C	1810mm	1860mm
D	735mm	735mm

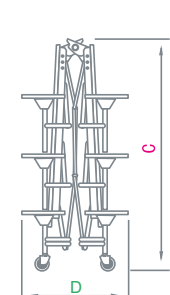
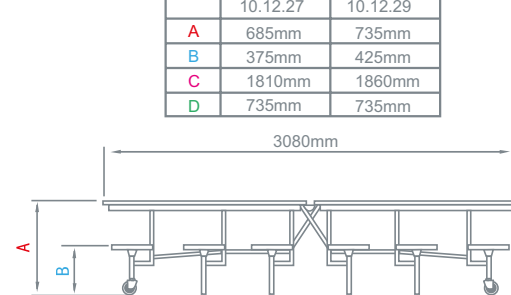

### Popular

The twelve seat dining unit is the most popular configuration amongst schools with fourteen table top colours to choose from and two height options. The sturdy and flexible design is functional, practical and easy to use.



# Dining Furniture

## 16 Seat Rectangular Mobile Folding Table

- Mobile folding table with grey frame which is easy to fold, store and clean
- Laminated table top with tough edging and MDF core (water resistant and easy clean)
- Fits through standard height doorway (1980mm) for storage and transportation
- Open position safety lock (to ensure table does not revert to folding position)
- Easy-clean intermediate lock for improved hygiene
- Transport and storage locking positions
- 16 year warranty on welds and mechanism
- Primary height 650mm
- Heavy duty locking castors
- 14 table top colours to choose from
- 11 stool colours to choose from
- FIRA certified



Rectangular Mobile Folding Table (16 Seat Unit)

Code

650(h) x 3280(w) x 1500mm (d)

9SRL101625

### Table Top Colour Option

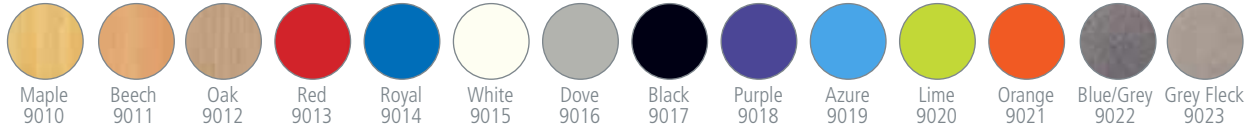

### Stool Colour Options



Model Rectangular 1016

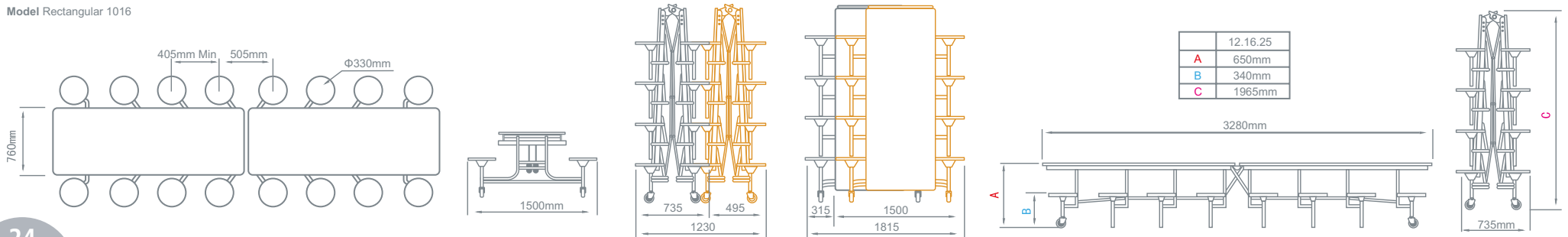



### Functional

Designed specifically for primary use, the sixteen seat mobile folding unit is the ideal dining solution for younger children, not only is it easy to clean but when not in use, is easy to store too.



# Dining Furniture

## Convertible Bench Unit - 3 benches in 1

- Versatile bench unit perfect for auditorium and classroom seating
- Join two units together to create a configuration ideal for cafeteria/dining use
- Laminated table top and bench with tough edging and MDF core (water resistant and easy clean)
- Each bench seats between 4-6 children (depending on age)
- Choice of two heights (primary and secondary)
- Heavy duty locking castors
- 14 colours to choose from
- FIRA certified
- 16 year warranty on welds and mechanism



### Convertible Bench Unit

685(h) x 2435(w) x 730mm (d)

735(h) x 2435(w) x 730mm (d)

### Code

9SLCB827

9SLCB829



Classroom Configuration



Auditorium Configuration

### Colour Option

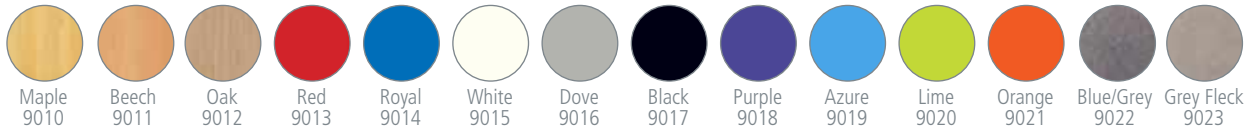

### Model Folding Convertible Bench Unit

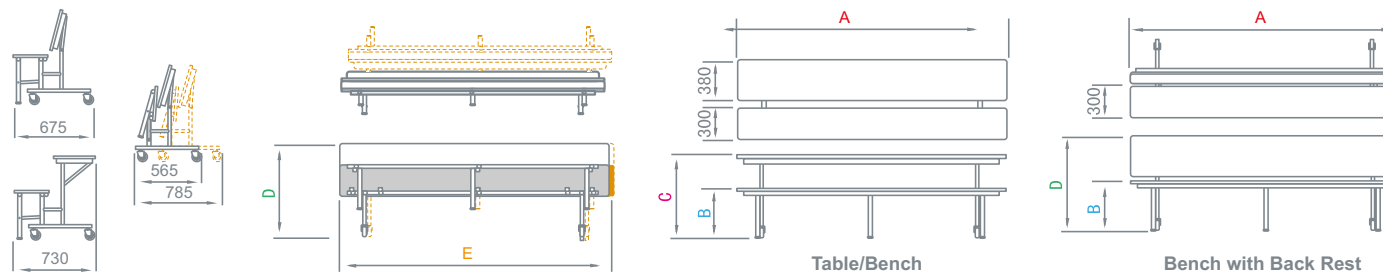

All sizes are in millimeters

	8ft - 27	8ft - 29
A	2435mm	2435mm
B	375mm	425mm
C	685mm	735mm
D	800mm	850mm
E	2485mm	2485mm

### Convertible

Versatile in design, the bench unit is effectively three benches in one. Ideal for auditorium style seating, it can also be converted to a classroom table and then, by joining two units together, is perfect for dining use.



Cafeteria Configuration (when two units are joined)

# Dining Furniture

## Mobile Folding Bench Unit

- Mobile folding bench which seats between 12-16 children (depending on age)
- Easily accessible for children, through six obstacle free entrances
- Laminated table top and bench with tough edging and MDF core (water resistant and easy clean)
- Fits through standard height doorway (1980mm) for storage and transportation
- Open position safety lock (to ensure table does not revert to folding position)
- Easy-clean intermediate lock for improve hygiene
- Choice of two heights (primary and secondary)
- 16 year warranty on welds and mechanism
- Heavy duty locking castors
- 14 colours to choose from
- FIRA certified



### Mobile Folding Bench

685(h) x 3080(w) x 1400mm (d)  
735(h) x 3080(w) x 1400mm (d)

### Code

9SLBU1027  
9SLBU1029

### Colour Option

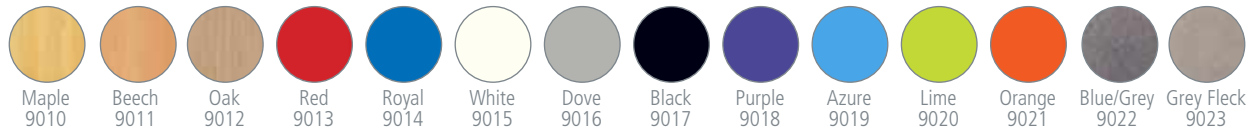

### Model Folding Rectangular Bench Unit

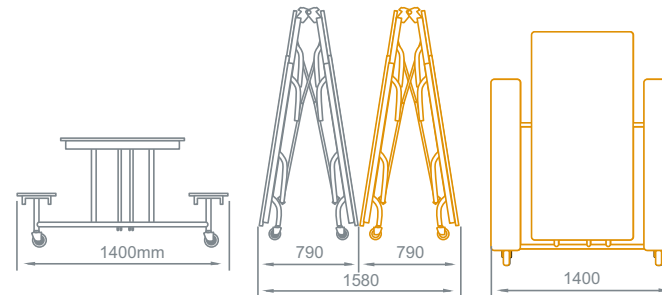
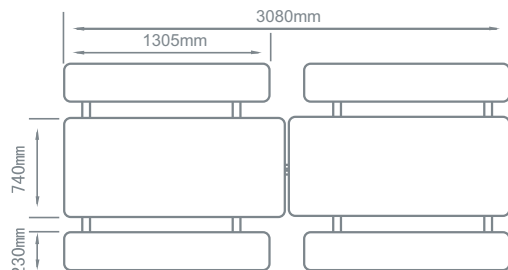

	27	29
A	685mm	735mm
B	375mm	425mm
C	1800mm	1850mm

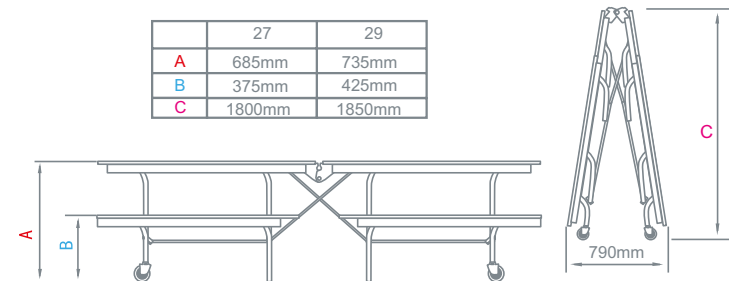

### Accessible

The mobile folding bench is ideal for busy lunch times, and seats between twelve and sixteen children. This unit has the added benefit of being easily accessible through six obstacle free entrances.



# Dining Furniture

Spaceright Europe Ltd are experts in the manufacture and supply of mobile folding tables with many years experience in delivering high value contracts and servicing the education sector.

We offer a completely free and comprehensive site survey and space planning service for our dining furniture range. So whether you have a detailed vision of what you want or need inspiration, we can provide a solution which is right for you.

## Required Maintenance

To keep your tables operating to the optimum level, they must be checked on an ongoing basis as follows:

- Regularly inspect table operation for smoothness and general stability.
- Clean table tops according to current food service hygiene practices after each use. Exterior components of tables should be inspected for food deposits and cleaned as required. The underside of the tables should be inspected for chewing gum and other food deposits.
- Periodically you should lubricate tables with a food grade silicon spray, which is required to pivot joints. We recommend lubrication every six months or more often if indicated by stiff operation or noise.

CAUTION:- Excessive use of water during cleaning may cause corrosion

## Folding Table Operating Instructions

### Moving The Folding Table



With travel lock engaged push from the seats as shown.



Do **NOT** push the surface of the table.



Avoid litter & obstacles on the floor.

### Opening The Folding Table



With your left hand pushing down the travel lock, push apart the stool unit with your right hand on the middle stool.



Continue opening by pressing down with both hands on the middle stools.



Continue opening by pressing down with both hands on the centre stools.

### Closing The Folding Table



Release locking bar by pressing down on the table surface, with right hand lift clear the lock.



Continue to lift using centre stools.



Using the middle stools push together to engage travel lock.

# 3D Space Planning

## Site Survey (Free of charge service)

To help with the buying process, we would be delighted to arrange a free site survey. Your dedicated Account Manager will visit you to discuss your requirements and take the necessary measurements.

This information will then be discussed between your Account Manager and our Product Design Engineers to produce layout plans.

## 3D Space Planning (Free of charge service)

One of the most important services we provide to our customers is delivering detailed, aesthetic designs of cafeteria/dining room layouts. To produce these, we employ qualified Product Design Engineers who are experts in creating bespoke dining solutions and space plans.

These designs are produced using modern 3D CAD (computer aided design) programmes to give a detailed idea of how the environment will look and feel. Using sophisticated modern 3D CAD engineering software, structural and finite element analysis is performed on all new designs to ensure that the most efficient and high performing solution is provided. These efforts result in high quality products at great value prices that our customers trust and that we are proud of.

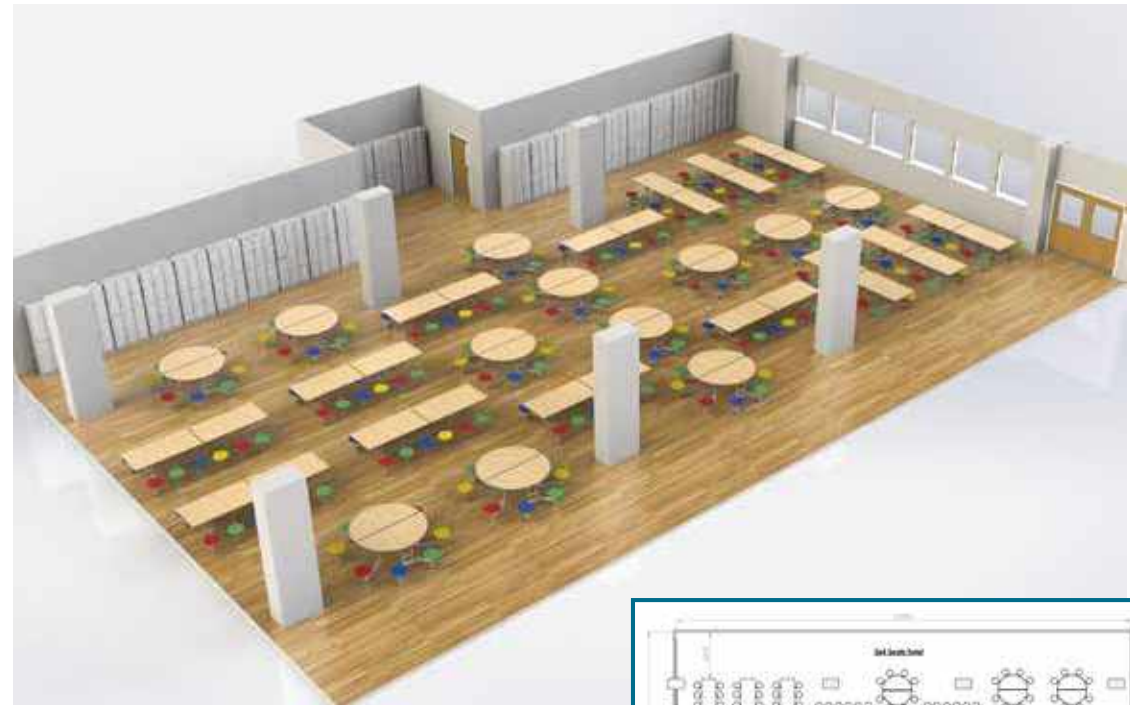

3D space plan for 14 x 12 seat rectangular and 12 x 8 seat round tables

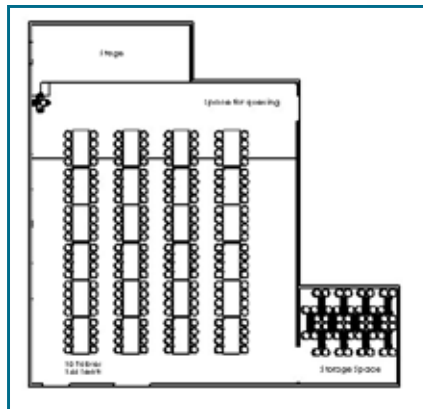
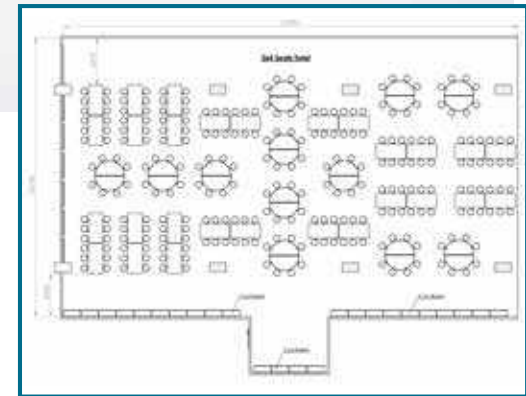

3D space plan for 12 x 12 seat rectangular tables

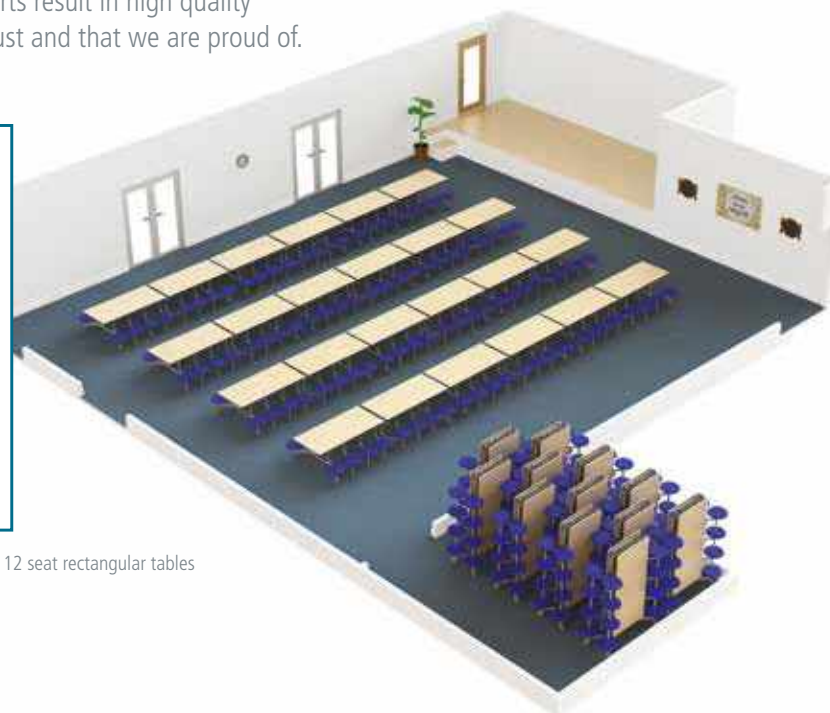

# Writing Boards

Writing boards are an effective way to present information, whether it be for education, training, or corporate use.

From traditional writing boards such as our renowned Wilson and Garden rollerboards, to efficient space saving solutions, we have a wide selection of writing boards to accommodate different requirements.

All of our writing boards feature a high quality, durable surface and benefit from a surface guarantee.

- High quality writing surface
- Designed to be practical and efficient
- Large selection of frame types and sizes
- Magnetic, non-magnetic and chalk surface options

## Writing Board Contents

	Page
Writing Boards	33-44
Writing Board Systems	45-46
Eco Writing and Chalkboards	47-48
Rollerboards	49-51
Glass Boards	52-54





# Writing Boards



## Non-Magnetic Writing Board

- Non-magnetic double-sided whiteboard
- Plain one side, grid on reverse
- Satin silver anodised aluminium frame
- Rounded safety corners and concealed corner fixing
- Pen ledge and wall fixings included
- Suitable for portrait or landscape use
- 5 year surface guarantee

## Non-Magnetic Writing Board

- Non-magnetic double-sided whiteboard
- Plain one side, grid on reverse
- Satin silver anodised aluminium frame
- Rounded safety corners and concealed corner fixing
- Pen ledge and wall fixings included
- Suitable for portrait or landscape use
- 10 year surface guarantee



5 Year Surface Guarantee	Code
900(w) X 600mm(h)	0106
1200(w) X 900mm(h)	0109
1200(w) X 1200mm(h)	0112
1500(w) X 1200mm(h)	0115
1800(w) X 1200mm(h)	0118
2400(w) X 1200mm(h)	0124

10 Year Surface Guarantee	Code
900(w) X 600mm(h)	0806
1200(w) X 900mm(h)	0809
1200(w) X 1200mm(h)	0812
1500(w) X 1200mm(h)	0815
1800(w) X 1200mm(h)	0818
2400(w) X 1200mm(h)	0824

## Non-Magnetic Frameless Colourmaster Writing Board

- Non-magnetic double-sided whiteboard with modern curved colour profile
- Plain one side, grid on reverse
- Ideal for mounting side by side
- Colour co-ordinated fixing kit included
- Suitable for portrait or landscape use
- 4 colour options to choose from
- 5 year surface guarantee

Non-Magnetic Writing Board	Code
900(w) X 600mm(h)	0206
1200(w) X 900mm(h)	0209
1500(w) X 1200mm(h)	0215
1800(w) X 1200mm(h)	0218
2400(w) X 1200mm(h)	0224



## Colour Options (Frameless Board)

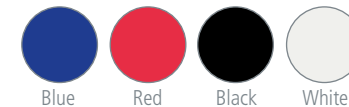

# Agenda

- Sales Figures
- Marketing Activity
- Future Actions
- AOB

## Practical

The double-sided design of this non-magnetic whiteboard brings a practical element to the product, adding value and increasing the life span. Our easy clean whiteboard surfaces are suitable for use with any standard dry wipe pens.

# Writing Boards



## Magnetic Writing Board (Coated Steel)

- Magnetic whiteboard constructed from coated steel
- Satin silver anodised aluminium frame
- Rounded safety corners and concealed corner fixing
- Pen ledge and wall fixings included
- Suitable for portrait or landscape use
- 5 year surface guarantee



Magnetic Writing Board	Code
900(w) X 600mm(h)	95151
1200(w) X 900mm(h)	95152
1200(w) X 1200mm(h)	95153
1500(w) X 1200mm(h)	95157
1800(w) X 1200mm(h)	95158
2400(w) X 1200mm(h)	95159



## Magnetic Writing Board (Vitreous Enamel Steel)

- Superior magnetic vitreous enamel steel writing board
- Durable anti-scratch resistant surface for heavy use
- Satin silver anodised aluminium frame
- Rounded safety corners and concealed corner fixing
- Pen ledge and wall fixings included
- Suitable for portrait or landscape use
- 25 year surface guarantee



Magnetic VES Writing Board	Code
900(w) X 600mm(h)	1306
1200(w) X 900mm(h)	1309
1200(w) X 1200mm(h)	1312
1500(w) X 1200mm(h)	1315
1800(w) X 1200mm(h)	1318
2400(w) X 1200mm(h)	1324



## Magnetic Projection Board

- Dual use vitreous enamel steel projection board and magnetic writing surface
- Semi-matt surface finish to reduce projection glare
- Satin silver anodised aluminium frame
- Rounded safety corners and concealed corner fixing
- Pen ledge and wall fixings are included
- Suitable for portrait or landscape use
- 25 year surface guarantee



Magnetic VES Projection Board	Code
1200(w) X 1200mm(h)	1112
1500(w) X 1200mm(h)	1115
1800(w) X 1200mm(h)	1118
2400(w) X 1200mm(h)	1124

## Writing Board Accessories



Dry Wipe Pens	
Size	Code
Pk 4	DMPENSTASS4



Mini Dusters	
Size	Code
Pk 30	MINIDUSTER30



Dusters	
Size	Code
Single	WBERAS1
Pk12	WBERAS12



Board Conditioner	
Size	Code
250ml Spray	COND.25
1.0lt Bottle	COND1
2.5lt Bottle	COND2.5



**Mag-notes**

- Re-useable magnetic drywipe notelets
- Suitable for use on magnetic/metal surfaces
- Ideal for office or education use
- Perfect for planning, presentations and more
- Pack of 40
- 10 of each colour: yellow, blue, pink, green
- 1 year guarantee

**NEW**

Mag-notes (Pack of 40)	Code
75(w) X 75mm(h)	95200/40



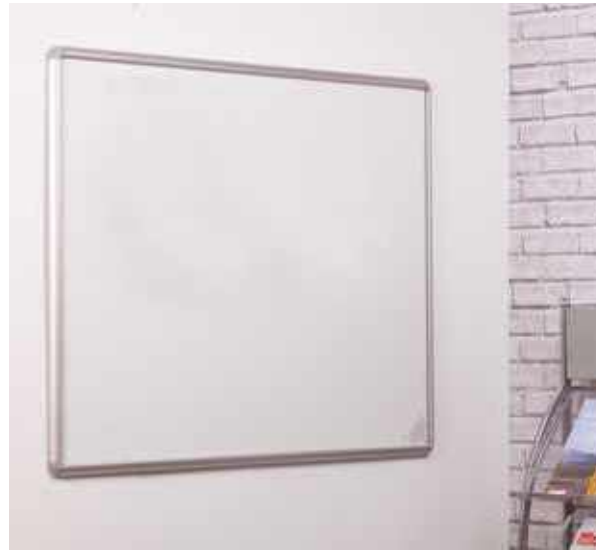

### Non-Magnetic SmartShield Writing Board

- Non-magnetic whiteboard with stylish frame
- Premium finish and modern design
- Choice of 2 frame colours: aluminium or blue
- Rounded safety corners and concealed corner fixing
- Pen ledge and wall fixings included
- Suitable for portrait or landscape use
- 5 year surface guarantee

### Magnetic SmartShield Writing Boards

- Magnetic whiteboard with stylish frame
- Premium finish and modern design
- Choice of 2 frame colours: aluminium or blue
- Rounded safety corners and concealed corner fixing
- Pen ledge and wall fixings included
- Suitable for portrait or landscape use
- 5 year surface guarantee

Non-Magnetic SmartShield Writing Board	Code
900(w) X 600mm(h)	4731
1200(w) X 900mm(h)	4732
1200(w) X 1200mm(h)	4733
1500(w) X 1200mm(h)	4734
1800(w) X 1200mm(h)	4735
2400(w) X 1200mm(h)	4736

Magnetic SmartShield Writing Board	Code
900(w) X 600mm(h)	4741
1200(w) X 900mm(h)	4742
1200(w) X 1200mm(h)	4743
1500(w) X 1200mm(h)	4744
1800(w) X 1200mm(h)	4745
2400(w) X 1200mm(h)	4746



Blue Frame



Aluminium Frame

# Agenda

- Review of previous minutes
- Quality review

## Flexible

Magnetic writing boards have the added benefit of being able to hold notices and display printed documents. These can be easily repositioned as required, and can be used alongside hand written information on the board surface.

# Writing Boards



## Non-Magnetic Mobile Writing Board

- Double-sided, non-magnetic writing board
- Plain one side, feint grid on reverse
- Mobile frame with locking castors and stability bar
- Portrait and landscape orientation available
- Height adjustable by 210 mm
- 5 year surface guarantee

Non-Magnetic Writing Board Landscape	Code
900(w) X 600mm(h)	1601L
1200(w) X 900mm(h)	1603L
1200(w) X 1200mm(h)	1605
1500(w) X 1200mm(h)	1607L
1800(w) X 1200mm(h)	1609L

Non-Magnetic Writing Board Portrait	Code
600(w) X 900mm(h)	1601P
900(w) X 1200mm(h)	1603P
1200(w) X 1500mm(h)	1607P



## Magnetic Mobile Writing Board

- Double-sided, magnetic writing board
- Plain both sides
- Mobile frame with locking castors and stability bar
- Portrait and landscape orientation available
- Height adjustable by 210 mm
- 5 year surface guarantee

Magnetic Writing Board Landscape	Code
900(w) X 600mm(h)	1611L
1200(w) X 900mm(h)	1613L
1200(w) X 1200mm(h)	1615
1500(w) X 1200mm(h)	1617L
1800(w) X 1200mm(h)	1619L

Magnetic Writing Board Portrait	Code
600(w) X 900mm(h)	1611P
900(w) X 1200mm(h)	1613P
1200(w) X 1500mm(h)	1617P

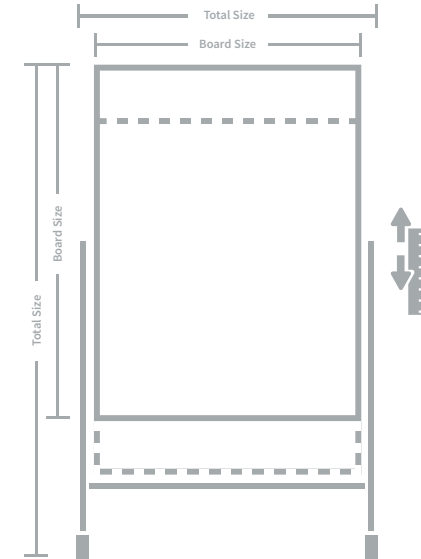

Board Size (w x h)	Total Size (w x h)
600 x 900 mm Portrait	640 x 1580 mm
900 x 600 mm Landscape	940 x 1420 mm
900 x 1200 mm Portrait	940 x 1730 mm
1200 x 900 mm Landscape	1240 x 1580 mm
1200 x 1200 mm Square	1240 x 1730 mm
1200 x 1500 mm Portrait	1240 x 1880 mm
1500 x 1200 mm Landscape	1540 x 1730 mm
1800 x 1200 mm Landscape	1840 x 1730 mm



### Adaptable

These mobile boards have two writing surfaces to maximise writing space. The sturdy frame and locking castors make it easy to transport the boards between different rooms or to position closer to the audience.

# Agenda

- Review of last meeting
- Annual review
- Points to note
- Date of next meeting





# Writing Boards

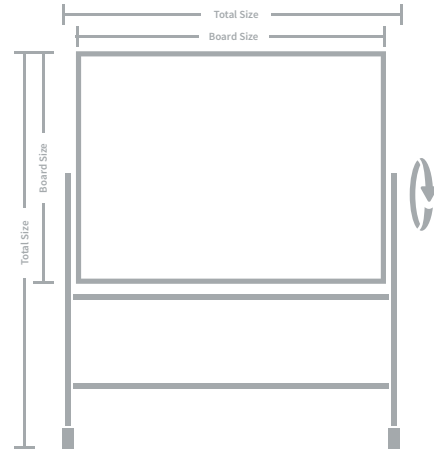

Swivel Board

## Mobile Swivel Writing Board

- Double-sided swivel board
- Magnetic: plain/plain surface, non-magnetic: plain/grid surface
- Rotates 360 degrees on the horizontal axis
- Tilt and lock in any position
- Mobile frame with locking castors and stability bar
- 5 year surface guarantee



Board Size (w x h)	Total Size (w x h)
900 x 1200 mm	1000 x 1935 mm
1200 x 900 mm	1300 x 1785 mm
1200 x 1200 mm	1300 x 1935 mm
1500 x 1200 mm	1600 x 1935 mm
1800 x 1200 mm	1900 x 1935 mm

Non-Magnetic Swivel Writing Board	Code
900(w) X 1200mm(h) Portrait	1260
1200(w) X 900mm(h) Landscape	1261
1200(w) X 1200mm(h)	1262
1500(w) X 1200mm(h) Landscape	1263
1800(w) X 1200mm(h) Landscape	1264

Magnetic Swivel Writing Board	Code
900(w) X 1200mm(h) Portrait	1220
1200(w) X 900mm(h) Landscape	1221
1200(w) X 1200mm(h)	1222
1500(w) X 1200mm(h) Landscape	1223
1800(w) X 1200mm(h) Landscape	1224

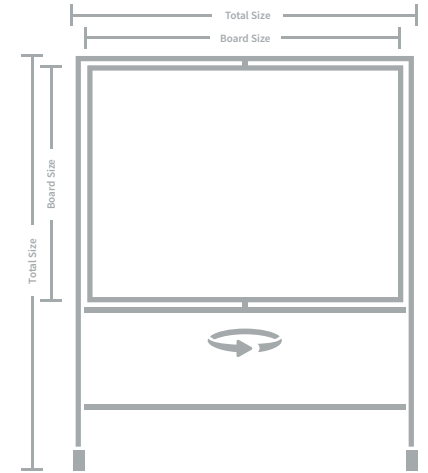

Pivot Board

## Mobile Pivot Writing Board

- Double-sided pivot board
- Magnetic: plain/plain surface, non-magnetic: plain/grid surface
- Assemble to rotate on either the vertical or horizontal axis
- Rotates 360 degrees in either direction
- Locks in any position
- Mobile frame with locking castors and stability bar
- 5 year surface guarantee



Board Size (w x h)	Total Size (w x h)
900 x 1200 mm	1000 x 1965 mm
1200 x 900 mm	1300 x 1965 mm
1200 x 1200 mm	1300 x 1965 mm
1500 x 1200 mm	1600 x 1965 mm
1800 x 1200 mm	1900 x 1965 mm

Non-Magnetic Pivot Writing Board	Code
900(w) X 1200mm(h) Portrait	1280
1200(w) X 900mm(h) Landscape	1281
1200(w) X 1200mm(h)	1282
1500(w) X 1200mm(h) Landscape	1283
1800(w) X 1200mm(h) Landscape	1284

Magnetic Pivot Writing Board	Code
900(w) X 1200mm(h) Portrait	1275
1200(w) X 900mm(h) Landscape	1276
1200(w) X 1200mm(h)	1277
1500(w) X 1200mm(h) Landscape	1278
1800(w) X 1200mm(h) Landscape	1279





## Sales Meeting

- Sales figures
- Business development
- Actions required



### Adjustable

The mobile pivot and swivel boards have two writing surfaces, with the added benefit of allowing you to angle the board and lock it in any position. The sturdy frame features locking castors and a stability bar.

# Writing Boards



## Music Stave Writing Board

- Ideal for teaching
- Non-magnetic surface
- Satin silver anodised aluminium frame
- Rounded safety corners and concealed corner fixing
- Pen ledge and wall fixings included
- 5 year surface guarantee

Writing Board with Music Staves	Code
900(w) X 600mm(h)	0131M
1200(w) X 900mm(h)	0132M
1200(w) X 1200mm(h)	0133M
1500(w) X 1200mm(h)	0134M
1800(w) X 1200mm(h)	0136M
2400(w) X 1200mm(h)	0138M



75mm Line Markings

## Non-Magnetic Lines/Square Writing Boards

- Writing boards with 75mm lines or 50mm squares
- Non-magnetic surface
- Perfect for teaching/training environments
- Satin silver anodised aluminium frame
- Rounded safety corners and concealed corner fixing
- Pen ledge and wall fixings included
- 5 year surface guarantee

Writing Board 50mm Squares	Code
900(w) X 600mm(h)	0131G50
1200(w) X 900mm(h)	0132G50
1200(w) X 1200mm(h)	0133G50
1500(w) X 1200mm(h)	0134G50
1800(w) X 1200mm(h)	0136G50
2400(w) X 1200mm(h)	0138G50

Writing Board 75mm Lines	Code
900(w) X 600mm(h)	0131L75
1200(w) X 900mm(h)	0132L75
1200(w) X 1200mm(h)	0133L75
1500(w) X 1200mm(h)	0134L75
1800(w) X 1200mm(h)	0136L75
2400(w) X 1200mm(h)	0138L75

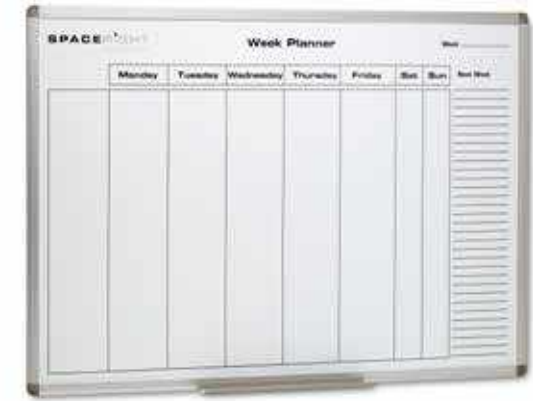

## Magnetic Planners

- 3 printed design options: weekly, monthly and annual
- Magnetic board surface 900(w) x 600mm(h)
- Spacious layout for notes and key coding
- Satin silver anodised aluminium frame
- Rounded safety corners and concealed corner fixing
- Pen ledge and wall fixings included
- 5 year surface guarantee



Magnetic Writing Board	Code
Weekly Planner	95602
Monthly Planner	95601
Yearly Planner	95600



Monthly Planner



Annual Planner



### Organised

Whether it's organising dates or organising information, these writing boards help you to present information in a clear, concise and efficient manner. Choose from weekly, monthly or annual.



# Writing Boards

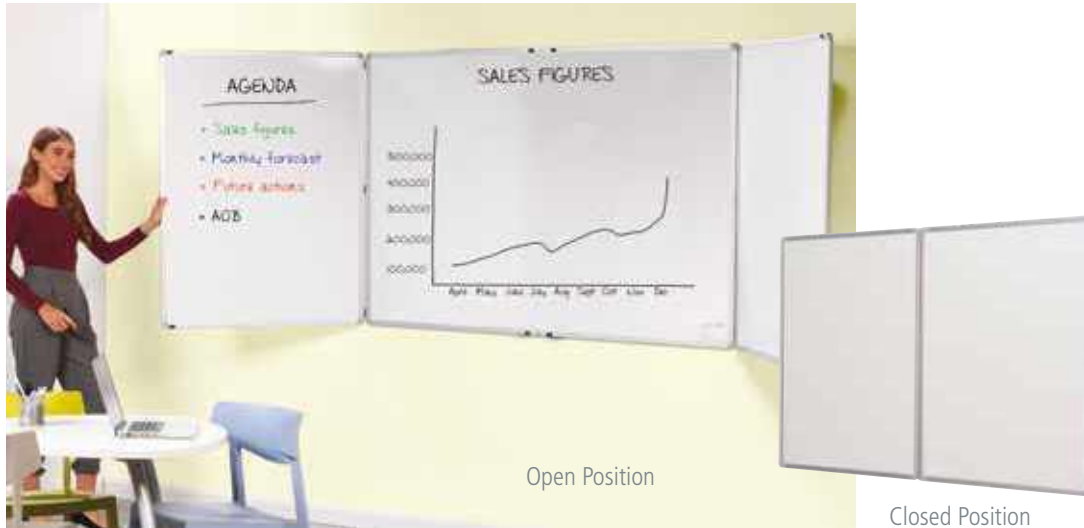

Open Position

Closed Position

## Spacesaving Writing Boards

- Folding whiteboard system designed to be space efficient
- Wings are double-sided, creating additional writing areas (plain board surface with feint grid on the outside of wings)
- Boards are available with either a single or double wing
- Non-magnetic surface
- Satin silver anodised aluminium frame
- Rounded safety corners and concealed corner fixing
- Pen ledge and wall fixings included
- 5 year surface guarantee

Spacesaving Writing Board	Code
600(w) X 900mm(h) (Single Wing)	6120
900(w) X 1200mm(h) (Single Wing)	6121
1200(w) X 1200mm(h) (Single Wing)	6122
1800(w) X 1200mm(h) (Twin Wings)	6182
2400(w) X 1200mm(h) (Twin Wings)	6242

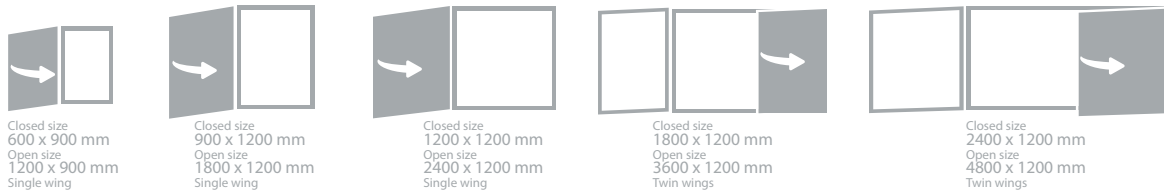

**Please make sure you have enough space to accommodate the open wings, these boards will double in width when wings are open. Minimum 1200mm clearance required from wall.**



Sliding Detail

## Sliding Writing Board System

- Sliding writing board system with non-magnetic surface
- Full back board with 1 or 2 sliding boards
- System fitted with 3 channels so sliding boards can overlap
- Nylon glides provide an easy sliding action
- White anodised aluminium frame
- Wall fixings included
- 5 year surface guarantee

### Sliding Writing Board System (1 sliding board) Code

Writing space 3300(w) X 1200mm (h)	
2400(w) X 1200mm(h) Board Size	2790

### Sliding Writing Board System (2 sliding board) Code

Writing space 4200(w) X 1200mm (h)	
2400(w) X 1200mm(h) Board Size	2791

## Writing Board Accessories

Dry Wipe Pens

Size	Code
Pk10 Black	DMPENSTBK10
Pk10 Blue	DMPENSTBU10
Pk10 Red	DMPENSTRD10
Pk10 Green	DMPENSTGN10

Board Cleaner

Size	Code
250ml Spray	DWS.25
1.0lt Bottle	DWC1
2.5lt Bottle	DWC2.5



**Mobile Presentation Board**

- Double-sided writing board with sturdy steel frame
- Magnetic dry wipe surface both sides
- 1200(w) X 1800mm(h) surface area
- Mobile design allows board to be easily transported between rooms or positioned close to the audience
- Ideal for use as partition or room divider
- Multiple boards can be butted together to form a larger surface area or partition
- Features 4 locking castors (plus 2 non-locking)
- 5 year surface guarantee

**NEW**

<b>Mobile Presentation Board</b>	<b>Code</b>
1300(w) X 1940mm(h)	2971



**Writing Board Accessories**



Dry Wipe Pens

Size	Code
Pk 4	DMPENSTASS4



Dusters

Size	Code
Single	WBERAS1
Pk12	WBERAS12



**NEW**

Mag-notes

Size	Code
Pk40	95200/40



# Writing Boards



## Chalk Writing Boards

- Chalk writing board with non-reflective surface
- Satin silver anodised aluminium frame
- Rounded safety corners and concealed corner fixing
- Chalk ledge and wall fixings included
- Non-magnetic
- Suitable for portrait or landscape use
- 5 year surface guarantee

Chalk Writing Board	Code
900(w) X 600mm(h)	1006
1200(w) X 900mm(h)	1009
1200(w) X 1200mm(h)	1012
1500(w) X 1200mm(h)	1015
1800(w) X 1200mm(h)	1018
2400(w) X 1200mm(h)	1024



## Eco Friendly Chalk Writing Board

- Chalk writing board with non-reflective surface
- Wood effect beech frame
- Constructed from a high proportion of recycled material
- Wall fixings included
- Non-magnetic
- Suitable for portrait or landscape use
- 5 year surface guarantee

Eco Friendly Chalk Writing Board	Code
900(w) X 600mm(h)	1031
1200(w) X 900mm(h)	1032
1200(w) X 1200mm(h)	1033
1500(w) X 1200mm(h)	1034
1800(w) X 1200mm(h)	1035
2400(w) X 1200mm(h)	1036



## Eco Friendly Writing Board

- Non-magnetic writing board
- Wood effect beech frame
- Constructed from a high proportion of recycled material
- Wall fixings included
- Suitable for portrait or landscape use
- 5 year surface guarantee

Eco Friendly Writing Board	Code
900(w) X 600mm(h)	1850
1200(w) X 900mm(h)	1851
1200(w) X 1200mm(h)	1852
1500(w) X 1200mm(h)	1853
1800(w) X 1200mm(h)	1854
2400(w) X 1200mm(h)	1855



## Writing Board Accessories

 <p>Chalk</p>		 <p>Chalk Duster</p>		 <p>Dry Wipe Pens</p>	
Colour	Code	Size	Code	Size	Code
White	CHLKOW100	Single	XLD	Pk 4	DMPENSTASS4
Assorted	CHLKOA100				

### Notable

Communicate in an effective manner using one of these boards and allow your message to be the most prominent feature. Simple but functional.

Staff  
Meeting 3pm



# Writing Boards



## Mobile Rollerboards

- Sturdy, durable, traditional construction
- Light wood veneered MDF frame
- 4 heavy duty castors
- 3 writing sections (plain dry wipe as standard)
- Other section options available at additional cost: 50mm square, 75mm lines, music staves, feint grid
- Writing surfaces can be replaced as required
- 1 year surface guarantee\*

Mobile Rollerboard (plain white)	Code
1293(w) X 1900mm(h) (3 section surface)	3210
1625(w) X 2315mm(h) (3 section surface)	3212



## Wall Mounted Rollerboards

- Sturdy, durable, traditional construction
- Light wood veneered MDF frame
- Wall fixings included
- 3 writing sections (plain dry wipe as standard)
- Other section options available at additional cost: 50mm square, 75mm lines, music staves, feint grid
- Writing surfaces can be replaced as required
- 1 year surface guarantee\*

Wall Mounted Rollerboard (plain white)	Code
1293(w) X 1877mm(h) (3 section surface)	3206B
1900(w) X 1320mm(h) (3 section surface)	3207



## Floor Standing Rollerboards

- Sturdy, durable, traditional construction, floor standing but fixed to wall
- Light wood veneered MDF frame
- Wall fixings included
- 3 or 4 writing sections depending on size (plain dry wipe as standard)
- Other section options available at additional cost: 50mm square, 75mm lines, music staves, feint grid
- Writing surfaces can be replaced as required
- 1 year surface guarantee\*

Floor Standing Rollerboard (plain white)	Code
1625(w) X 2277mm(h) (3 section surface)	3200
1927(w) X 2277mm(h) (3 section surface)	3201
2500(w) X 2277mm(h) (3 section surface)	3202
1625(w) X 2515mm(h) (4 section surface)	3203
1927(w) X 2515mm(h) (4 section surface)	3204
2500(w) X 2515mm(h) (4 section surface)	3205



\* Only when used with Spaceright approved pens and cleaner

For over 100 years rollerboards have played a pivotal role in education, and become a familiar feature in most classrooms and lecture theatres.

The sturdy and robust construction has become synonymous with reliability, whilst the revolving design offers versatility and the ability to present different information on each section. For this reason, rollerboards continue to be a core requirement for modern day teaching environments.

### Types of rollerboards:

- **Mobile**  
Ideal for small classrooms/teaching environments. The sturdy construction and mobile castors make it easy to move the rollerboard from room to room or within a room, as required.
- **Wall Mounted**  
The perfect solution for smaller spaces or where floor space is limited. The information on display is at a higher height than the mobile version and therefore more easily visible.
- **Floor Standing (fixed to wall)**  
Suitable for larger classrooms/teaching environments, the floor standing (wall fixed) rollerboard has large writing surfaces and is easily visible within a classroom, lecture theatre or similar. Each board has either 3 or 4 writing surface sections, depending on the size of the board.

For all of the above, plain white writing sections will be supplied as standard, however you can choose from the following types:  
50mm square, 75mm lines, music staves or feint grid (additional charge will apply).

Writing sections can easily be replaced as required. Please see page 28 for further information.



### Reliable

Rollerboards offer the ultimate reliable writing surface for education environments. Easy to clean and re-useable, each surface is made from high quality material for excellent performance.



### Replacement Sections

- Spaceright sections are suitable for any make of rollerboard and can be replaced as required
- Choose from: plain dry wipe, feint grid dry wipe, 50mm square dry wipe, 75mm lines dry wipe or music staves dry wipe
- Writing sections are easy to fit and fitting instructions are provided, however a fitting service is available if required (price on request)
- All sections carry a 1 year surface guarantee\*

Replacement Plain White Sections	Code
Width up to 1200mm(w)	9012
Width up to 1630mm(w)	9016
Width up to 1930mm(w)	9019
Width up to 2500mm(w)	9025

Replacement Ruled and Feint Grid Sections	Code
Width up to 1200mm(w)	9112
Width up to 1630mm(w)	9116
Width up to 1930mm(w)	9119
Width up to 2500mm(w)	9125

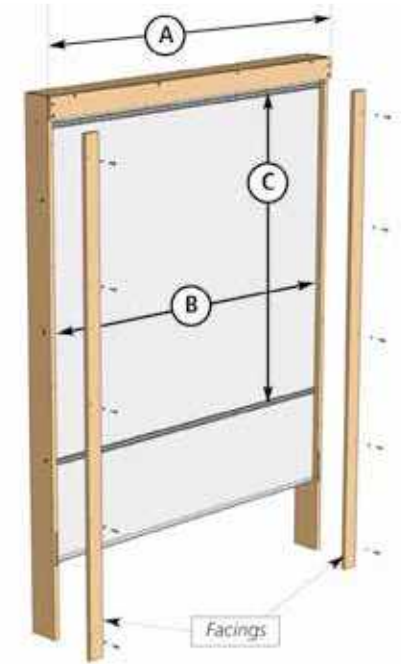

### Measuring Guide

To enable us to supply replacement writing sections made exactly to your requirements, we require the following key information:

1. Overall board width, including frame - A
2. Overall section width - B
3. Section height between connecting strip centres - C
4. Writing surface required for each section
5. If fitting is required, please also supply the location of the roller board e.g. Science lab

### Request an Inspection

If you have a requirement for new rollerboard surfaces or need help assessing the condition of your current board surfaces, we can help. Our qualified service team will visit and inspect your boards, leaving you a recommendation report on any maintenance/replacements required.

To book an inspection please call:

**0845 6017619**



# Writing Boards



Introduce a splash of colour with our stylish, magnetic, glass writing boards.

Made in the UK from recycled 4mm toughened safety glass with polished edges, these boards provide a durable, premium quality writing surface for presenting information.

The contemporary design makes an impressive visual impact and offers a refined alternative to conventional dry wipe boards. Our wall mounted glassboards are available in a variety of colours, with the option to create your own design.

- Stylish and contemporary design
- Made in the UK
- Magnetic surface for use with strong magnets
- Easy clean with dry wipe eraser
- Lifetime surface guarantee\*

\* Does not include accidental damage or misuse

## Wall Mounted Magnetic Glass Writing Board

- 4mm toughened safety glass
- 15 board colours to choose from
- 7 size options
- Contemporary chrome fixings
- Suitable for portrait or landscape use
- For best results use strong magnets
- Lifetime surface guarantee\*

## Customised Wall Mounted Magnetic Glass Writing Board

- 4mm toughened safety glass
- Choose any colour and any design
- 7 size options
- Contemporary chrome fixings
- Suitable for portrait or landscape use
- For best results use strong magnets
- Lifetime surface guarantee\*

Please see page 8 for further information on customisation

Wall Mounted Magnetic Glassboards	Code
600(w) X 450mm(h)	GW4S
900(w) X 600mm(h)	GW60
1000(w) X 650mm(h)	GW6S
1200(w) X 900mm(h)	GW90
1200(w) X 1200mm(h)	GW12
1500(w) X 1200mm(h)	GW15
1800(w) X 1200mm(h)	GW18

Customised Wall Mounted Glassboards	Code
600(w) X 450mm(h)	GWP4S
900(w) X 600mm(h)	GWP60
1000(w) X 650mm(h)	GWP6S
1200(w) X 900mm(h)	GWP90
1200(w) X 1200mm(h)	GWP12
1500(w) X 1200mm(h)	GWP15
1800(w) X 1200mm(h)	GWP18

## Colour Options





# Agenda

- Sales Figures
- How To Grow Sales
- Future Actions Required
- AOB

### Refined

With a frameless finish and polished edges, not only are our glass boards safe for use in an office or education environment, but they can be fitted side by side to create a seamless, large writing area.



## Design Your Own Glass Writing Board

Add a personal touch to any of the glass boards in our range by adding your logo, or if you are feeling creative, create your own unique glassboard design to incorporate your identity.

Sometimes business requirements mean that you need a product tailored to fulfil a particular task or convey a specific message. Our customised option allow you the flexibility to do just that, all you have to do is place your order telling us the size and style. We will then contact you to discuss your requirements and agree a design brief.

A proof will be sent for approval for all customised glassboards before print. From approval, the product lead time will be approximately 4 weeks. If at any point you'd like to discuss these products options in more detail, don't hesitate to contact us on **0845 6017619**.

*Please note all customised glassboards are non-returnable.*



Write'n' Wipe  
**Glassboards®**



# Flip Chart Easels

Easels are the quick, easy and efficient solution for presenting information to a group.

Whether it's for brainstorming, training, teaching or meetings, our range of easels is varied to suit different requirements. Mobile easels are perfect for moving from room to room and positioning close to the audience, whilst tripod and loop leg easels are ideal for storing away after use.

Within our range we offer both magnetic and non-magnetic surfaces and for additional display space, some of our easels have side bars to display multiple sheets at the same time.

Our easels also benefit from the following features:

- Strong, sturdy construction
- High quality dry wipe surface
- Height adjustable for flexibility
- Integrated flip chart clamp
- Pen ledge

## Flip Chart Easels Contents

	Page
Tripod Flip chart Easels	56-57
Mobile Flip chart Easels	58-59
Loop Leg Flip chart Easels	60





### Non-Magnetic Telescopic Flip Chart Easel

- Non-magnetic dry wipe surface
- 600(w) x 900mm(h) surface area
- Sturdy metal construction
- Telescopic leg design for easy storage
- Height adjustable by 700mm
- Foot print 600(w) x 750mm(d)
- Flip chart clamp (holds pads up to A1 size)
- Pen ledge
- 1 year surface guarantee

Non-Magnetic Flip Chart Easel	Code
600(w) X 1500mm(h)	3500

### 2 Clix Easel

- Non-magnetic dry wipe surface
- 600(w) x 900mm(h) surface area
- Simple two step operation
- No assembly required
- Incredibly stable metal construction
- Folds for easy storage
- Foot print 635(w) x 675mm(d)
- Flip chart clamp (holds pads up to A1 size)
- Full length pen ledge
- 2 colour options to choose from
- 1 year surface guarantee

Tripod 2 Clix Easel	Code
635(w) X 1600mm(h) Blue	95015
635(w) X 1600mm(h) Red	95016

### Colour Options (2 Clix Frame)

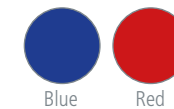





### Magnetic Telescopic Flip Chart Easel

- Magnetic dry wipe surface
- 700(w) x 1000mm(h) surface area
- Sturdy metal construction
- Telescopic leg design for easy storage
- Height adjustable by 700mm
- Foot print 700(w) x 750mm(d)
- Flip chart clamp (holds pads up to A1 size)
- Pen ledge
- 1 year surface guarantee



### Magnetic Telescopic Flip Chart Easel

Code

700(w) X 1700mm(h)

95010

**Effective**  
For effective display and presentation, telescopic easels are practical and easy to use. The sliding tubular design is sturdy in construction, height adjustable as required, and easy to store.



### Writing Board Accessories



Dry Wipe Pens

Size	Code
Pk 4	DMPENSTASS4



Dusters

Size	Code
Single	WBERAS1
Pk12	WBERAS12



**NEW**

Mag-notes

Size	Code
Pk40	95200/40



### Mobile Round Base Easel

- Choose from magnetic or non-magnetic surface
- 700(w) x 1000mm(h) surface area
- Height adjustable by 250mm
- Complete with side bars for displaying multiple sheets (3 x A1)
- Sturdy mobile base with 5 castors
- Foot print 700(w) x 600mm(d)
- Flip chart clamp (holds pads up to A1 size)
- Pen ledge
- White frame
- 1 year surface guarantee

#### Mobile Round Base Easel

700(w) X 1850mm(h) Non-magnetic

700(w) X 1850mm(h) Magnetic

#### Code

95111

95001



### Mobile Star Base Easel

- Choose from magnetic or non-magnetic surface
- 700(w) x 1000mm(h) surface area
- Height adjustable by 250mm
- Complete with side bars for displaying multiple sheets (3 x A1)
- Sturdy mobile star base with 5 castors
- Foot print 700(w) x 600mm(d)
- Flip chart clamp (holds pads up to A1 size)
- Pen ledge
- Black frame
- 1 year surface guarantee

#### Mobile Star Base Easel

700(w) X 1850mm(h) Non-magnetic

700(w) X 1850mm(h) Magnetic

#### Code

95333

95003





**UltraMate Magnetic Round Base Flip Chart Easel**

- Magnetic dry wipe surface
- 700(w) x 1000mm(h) surface area
- Height adjustable by 250mm
- Sturdy mobile base with 5 castors
- Foot print 700(w) x 600mm(d)
- Flip chart clamp (holds pads up to A1 size)
- Pen ledge
- 6 colour options to choose from
- 1 year surface guarantee

Magnetic Round Base UltraMate Easel	Code
700(w) X 1850mm(h) Black	95001BLK
700(w) X 1850mm(h) Blue	95001BL
700(w) X 1850mm(h) Red	95001R
700(w) X 1850mm(h) Green	95001GRN
700(w) X 1850mm(h) White	95001WH
700(w) X 1850mm(h) Grey	95001GRY

**Colour Options (UltraMate Round Base)**

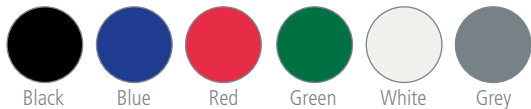

**Quality**  
 All of our easels benefit from a high quality dry wipe surface with the added advantage of an integrated flip chart clamp which can hold pads of up to A1 size. Ideal for meetings and presentations.



# Flip Chart Easels



## Ultramate Magnetic Loop Leg Flip Chart Easel

- Double-sided, magnetic dry wipe surface
- Lightweight, yet sturdy construction
- 700(w) x 1000mm(h) surface area
- Height adjustable by 700mm
- Surface tilts and rotates for ease of use
- Foot print 700(w) x 550mm(d)
- Flip chart clamp (holds pads up to A1 size)
- Pen ledge on one side
- 6 colour options to choose from
- 1 year surface guarantee

Ultramate Magnetic Loop Leg Easel	Code
700(w) X 1750mm(h) Black	95006
700(w) X 1750mm(h) Blue	95007
700(w) X 1750mm(h) Red	95008
700(w) X 1750mm(h) Green	95009GRN
700(w) X 1750mm(h) White	95009WH
700(w) X 1750mm(h) Grey	95009GRY

### Colour Options (Ultramate Loop Leg)

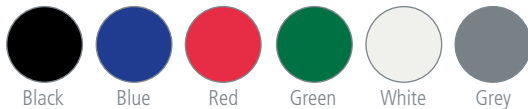

## Magnetic Conference Easel

- Magnetic white board surface
- Designed for high performance
- High quality aluminium frame
- 700(w) x 1000mm(h) surface area
- Height adjustable by 765mm
- Foot print 700(w) x 600mm(d)
- Legs interlock for easy carrying and storage
- Flip chart clamp (holds pads up to A1 size)
- Full length pen ledge
- 3 year surface guarantee



Magnetic Conference Easel	Code
700(w) X 1700mm(h)	95014

## Writing Board Accessories



Dry Wipe Pens

Size	Code
Pk 4	DMPENSTASS4



Dusters

Size	Code
Single	WBERAS1
Pk12	WBERAS12



NEW

Mag-notes

Size	Code
Pk40	95200/40

# WeatherShield Showcases & Signage

Present your information in a professional manner with the WeatherShield showcase and signage range.

Each showcase features gas strut assisted doors which will remain in position when opened for ease of use and hassle free changing of information. The double locking system and virtually shatterproof glazing ensures that information within the showcase is safe and secure.

All WeatherShield showcases and signs are made from strong, durable aluminium, and are suitable for a variety of businesses and institutions including: schools, universities, leisure centres, child care centres and more.

Within the range we have a selection of WeatherShield signs which can be personalised to allow you to convey your identity to staff, pupils and visitors.

## WeatherShield Contents

	Page
WeatherShield Outdoor Showcases	62-63
WeatherShield Outdoor Signage	64-67
Junior WeatherShield Welcome Signs	68-69
WeatherShield Outdoor Writing Board	70

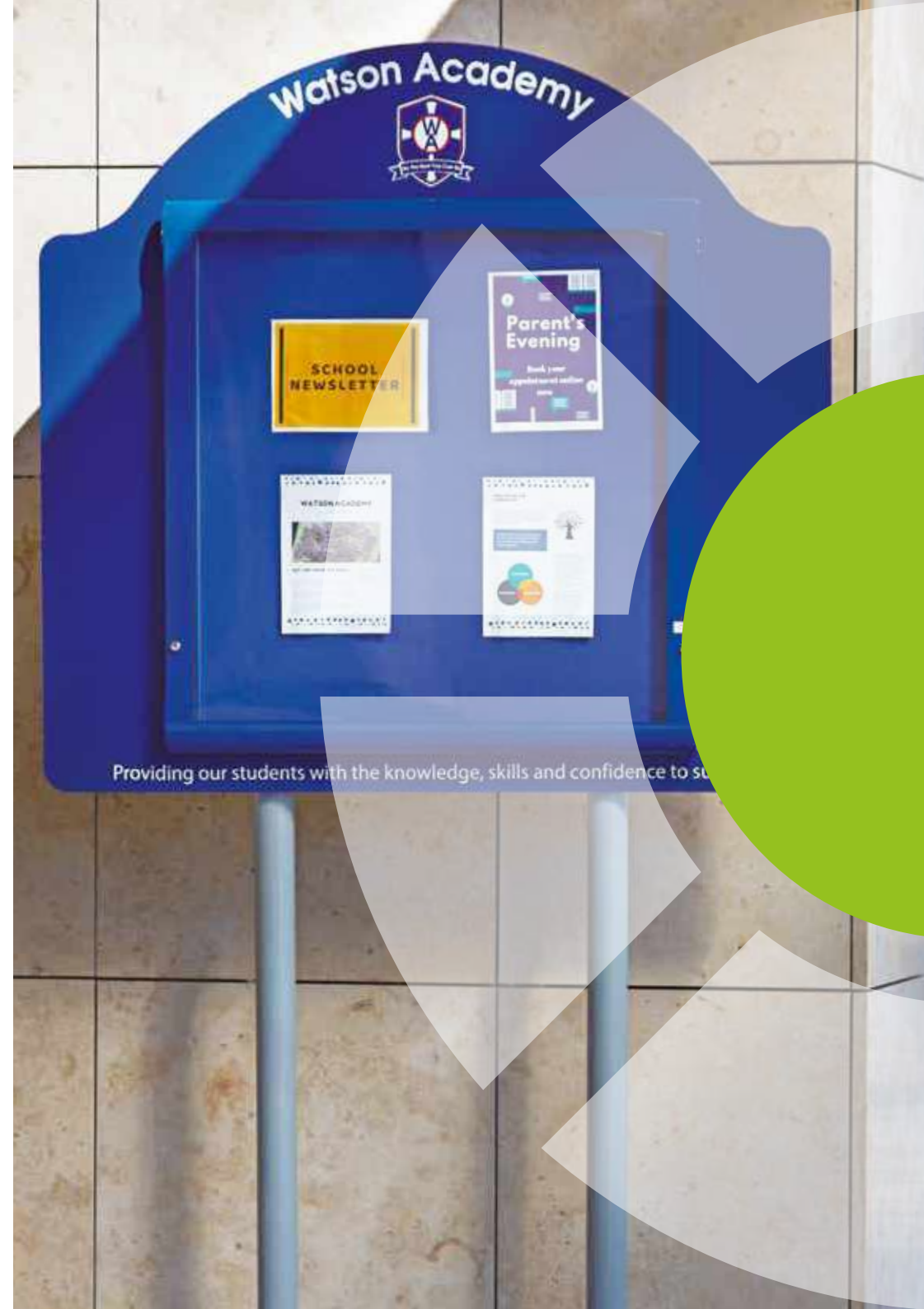

# WeatherShield Showcases & Signage



## WeatherShield Wall Mounted Outdoor Showcase

- Display information outdoors to visitors, staff and pupils
- Double seal and fully enclosed case protects from the elements and is IP55 certified (dust and water ingress)
- Virtually shatterproof PETG glazing
- Safe and secure double locking system
- Features gas strut assisted doors
- 5 colour options to choose from
- Wall fixings included
- Made in the UK
- 2 year product guarantee

WeatherShield Wall Mounted Showcase	Code
742(w) X 555mm(h)	7201
560(w) X 735mm(h)	7202
1005(w) X 735mm(h)	7203
780(w) X 1031mm(h)	7204
1005(w) X 1031mm(h)	7205
1220(w) X 1031mm(h)	7206
1423(w) X 1031mm(h)	7207



## WeatherShield Freestanding Outdoor Showcase

- Display information outdoors to visitors, staff and pupils
- Choose from sunken posts or surface mounted posts
- Grey aluminium powder coated legs
- Double seal and fully enclosed case protects from the elements and is IP55 certified (dust and water ingress)
- Virtually shatterproof PETG glazing
- Safe and secure double locking system
- Features gas strut assisted doors
- 5 colour options to choose from
- Made in the UK
- 2 year product guarantee

Freestanding Showcase (Sunken Posts)	Code
780(w) X 1031mm(h)	7401
1005(w) X 1031mm(h)	7402
1220(w) X 1031mm(h)	7403
1423(w) X 1031mm(h)	7404

Freestanding Showcase (Surface Posts)	Code
780(w) X 1031mm(h)	7411
1005(w) X 1031mm(h)	7412
1220(w) X 1031mm(h)	7413
1423(w) X 1031mm(h)	7414

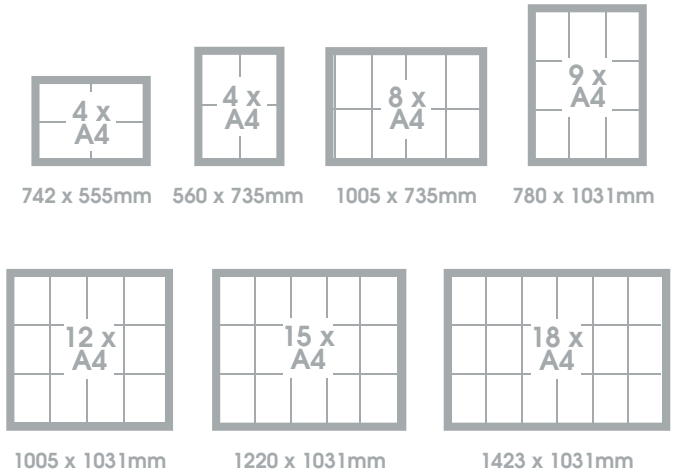

Surface Brackets

## Colour Options (Frame and Felt)



Red/Red Blue/Blue Green/Green Black/Grey Aluminium/Blue  
 Mix and match colour options are available on a non-refundable basis



For fitting instructions please see page 74.

## Impress

First impressions count. The WeatherShield showcase and signage range delivers your information to visitors, staff and pupils in a professional and eye catching manner that will make an impact.



# WeatherShield Showcases & Signage



## WeatherShield Contour Wall Mounted Outdoor Sign

- Personalised outdoor sign which incorporates name, logo or crest and footer text
- Double seal and fully enclosed showcase protects from the elements and is IP55 certified (dust and water ingress)
- Virtually shatterproof PETG glazing
- Safe and secure double locking system
- Features gas strut assisted doors
- 5 colour options to choose from
- Wall fixings included
- Made in the UK
- 2 year product guarantee

WeatherShield Contour Outdoor Sign	Code
750(w) X 1000mm(h) (4xA4 Landscape)	7480
750(w) X 1000mm(h) (4xA4 Portrait)	7481
1100(w) X 1400mm(h) (8xA4)	7482
1100(w) X 1400mm(h) (9xA4)	7483
1500(w) X 1400mm(h) (12xA4)	7408
1500(w) X 1400mm(h) (15xA4)	7484
1500(w) X 1400mm(h) (18xA4)	7485

## Colour Options (Frame and Felt)



## WeatherShield Contour Freestanding Outdoor Sign

- Personalised outdoor sign with name, logo or crest and footer text
- Choose from sunken posts or surface mounted posts
- Grey aluminium powder coated legs
- Double seal and fully enclosed showcase protects from the elements and is IP55 certified (dust and water ingress)
- Virtually shatterproof PETG glazing
- Safe and secure double locking system
- Features gas strut assisted doors
- 5 colour options to choose from
- Made in the UK
- 2 year product guarantee



Surface Brackets

Freestanding Contour Sign (Sunken Posts)	Code
750(w) X 1000mm(h) (4xA4 Landscape)	7450
750(w) X 1000mm(h) (4xA4 Portrait)	7451
1100(w) X 1400mm(h) (8xA4)	7452
1100(w) X 1400mm(h) (9xA4)	7453
1500(w) X 1400mm(h) (12xA4)	7406
1500(w) X 1400mm(h) (15xA4)	7454
1500(w) X 1400mm(h) (18xA4)	7455

Freestanding Contour Sign (Surface Posts)	Code
750(w) X 1000mm(h) (4xA4 Landscape)	7460
750(w) X 1000mm(h) (4xA4 Portrait)	7461
1100(w) X 1400mm(h) (8xA4)	7462
1100(w) X 1400mm(h) (9xA4)	7463
1500(w) X 1400mm(h) (12xA4)	7416
1500(w) X 1400mm(h) (15xA4)	7464
1500(w) X 1400mm(h) (18xA4)	7465

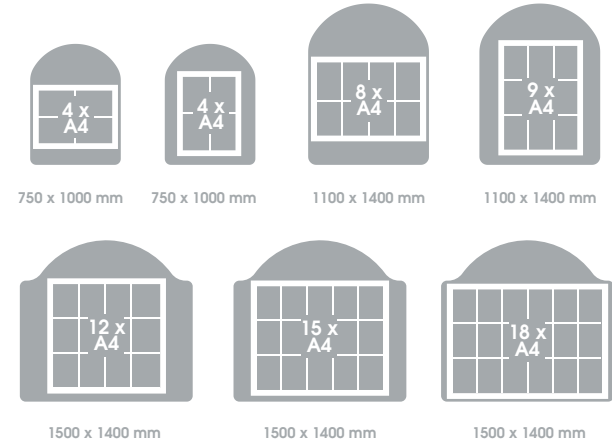

## Personalisation

WeatherShield Contour signs are personalised free of charge with your business/institution name, logo or crest and footer text (usually a mission statement). Simply select the size and colour required, then place your order. We will then contact you to confirm the details and request any artwork you may have. A proof will be supplied prior to print and the lead time is 4 weeks from artwork approval. All artwork is applied to the sign in waterproof vinyl. If at any point you have any queries, don't hesitate to contact us on 0845 6017619.

**Please note all personalised WeatherShield signs are non-returnable.**



For fitting instructions please see page 74.



### Promote

The WeatherShield Contour range effectively combines signage and display, allowing you to present information and notices outdoors, whilst promoting your school, university, college or business identity.



# WeatherShield Showcases & Signage



## WeatherShield Headline Wall Mounted Outdoor Sign

- Personalised outdoor sign with name
- Double seal and fully enclosed showcase protects from the elements and is IP55 certified (dust and water ingress)
- Name plate is 250mm high
- Virtually shatterproof PETG glazing
- Safe and secure double locking system
- Features gas strut assisted doors
- 5 colour options to choose from
- Wall fixings included
- Made in the UK
- 2 year product guarantee

WeatherShield Headline Outdoor Sign	Code
780(w) X 1281mm(h) (9xA4) single door	7472
1005(w) X 1281mm(h) (12xA4) single door	7473
1220(w) X 1281mm(h) (15xA4) single door	7474
1423(w) X 1281mm(h) (18xA4) single door	7475
1570(w) X 1281mm(h) (18xA4) double door	7476
2010(w) X 1281mm(h) (24xA4) double door	7477
2450(w) X 1281mm(h) (30xA4) double door	7478
2849(w) X 1281mm(h) (36xA4) double door	7479

## Colour Options (Frame and Felt)



## WeatherShield Headline Freestanding Outdoor Sign

- Personalised outdoor sign with name
- Choose from sunken posts or surface mounted posts
- Grey aluminium powder coated legs
- Double seal and fully enclosed showcase protects from the elements and is IP55 certified (dust and water ingress)
- Name plate is 250mm high
- Virtually shatterproof PETG glazing
- Safe and secure double locking system
- Features gas strut assisted doors
- 5 colour options to choose from
- Made in the UK
- 2 year product guarantee

Freestanding Headline Sign (Sunken Posts)	Code
780(w) X 1281mm(h) (9xA4) single door	7432
1005(w) X 1281mm(h) (12xA4) single door	7433
1220(w) X 1281mm(h) (15xA4) single door	7434
1423(w) X 1281mm(h) (18xA4) single door	7435
1570(w) X 1281mm(h) (18xA4) double door	7436
2010(w) X 1281mm(h) (24xA4) double door	7437
2450(w) X 1281mm(h) (30xA4) double door	7438
2849(w) X 1281mm(h) (36xA4) double door	7439

Freestanding Headline Sign (Surface Posts)	Code
780(w) X 1281mm(h) (9xA4) single door	7442
1005(w) X 1281mm(h) (12xA4) single door	7443
1220(w) X 1281mm(h) (15xA4) single door	7444
1423(w) X 1281mm(h) (18xA4) single door	7445
1570(w) X 1281mm(h) (18xA4) double door	7446
2010(w) X 1281mm(h) (24xA4) double door	7447
2450(w) X 1281mm(h) (30xA4) double door	7448
2849(w) X 1281mm(h) (36xA4) double door	7449

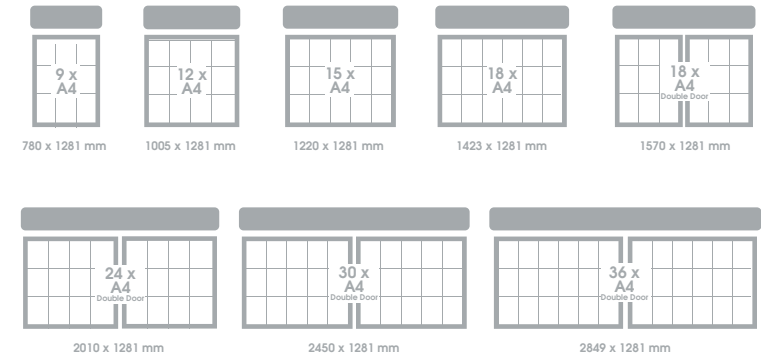

Surface Brackets



Post Fitment

## Personalisation

WeatherShield Contour signs are personalised free of charge with your business/institution name, logo or crest and footer text (usually a mission statement). Simply select the size and colour required, then place your order. We will then contact you to confirm the details and request any artwork you may have. A proof will be supplied prior to print and the lead time is 4 weeks from artwork approval. All artwork is applied to the sign in waterproof vinyl. If at any point you have any queries, don't hesitate to contact us on 0845 6017619.

**Please note all personalised WeatherShield signs are non-returnable.**



For fitting instructions please see page 74.

### Protect

WeatherShield Headline signage is perfect for displaying notices outdoors in a safe and secure environment. Information is protected from the elements in a waterproof showcase with a double locking system.

# Langland Community School



# WeatherShield Showcases & Signage



## WeatherShield Wall Mounted Landscape Welcome Sign

- Combined personalised signage and display showcase
- Ideal for schools, nurseries and childcare centres
- Sign backboard is heavy duty plastic which is weather and UV light resistant
- Double seal and fully enclosed showcase protects information/notices from the elements and is IP55 certified
- Aluminium showcase size is 742(w) X 555mm(h)
- Virtually shatterproof PETG glazing
- Safe and secure double locking system
- Features gas strut assisted door
- Wall fixings included
- Made in the UK
- 2 year product guarantee

WeatherShield Tree Welcome Sign	Code
1480(w) X 1480mm(h) (4xA4)	7424

WeatherShield Bee Welcome Sign	Code
944(w) X 1297mm(h) (4xA4)	7426

WeatherShield Star Welcome Sign	Code
1210(w) X 1310mm(h) (4xA4)	7429

WeatherShield Rainbow Welcome Sign	Code
1797(w) X 1054mm(h) (4xA4)	7427

## Personalisation

WeatherShield Junior signs are personalised free of charge with your school, nursery or institution name. Simply select the size and design required, then place your order. We will then contact you to confirm the details before processing your order. A proof will be supplied prior to print and the lead time is 4 weeks from artwork approval. If at any point you have any queries, don't hesitate to contact us on 0845 6017619.

**Please note all personalised WeatherShield signs are non-returnable.**



## WeatherShield Wall Mounted Portrait Welcome Sign

- Combined personalised signage and display showcase
- Ideal for schools, nurseries and childcare centres
- Sign backboard is heavy duty plastic which is weather and UV light resistant
- Double seal and fully enclosed showcase protects information/notices from the elements and is IP55 certified
- Aluminium showcase size is 560(w) X 735mm(h)
- Virtually shatterproof PETG glazing
- Safe and secure double locking system
- Features gas strut assisted door
- Wall fixings included
- Made in the UK
- 2 year product guarantee

WeatherShield Bear Welcome Sign	Code
933(w) X 1479mm(h) (4xA4)	7428

WeatherShield Monkey Welcome Sign	Code
902(w) X 1381mm(h) (4xA4)	7425





# WeatherShield Showcases & Signage



## WeatherShield Wall Mounted Magnetic Outdoor Showcase

- Display handwritten information or notices outdoors
- Magnetic dry wipe surface
- Double seal and fully enclosed case protects from the elements and is IP55 certified
- Virtually shatterproof PETG glazing
- Safe and secure double locking system
- Features gas strut assisted door
- 5 colour options to choose from
- Wall fixings included
- Made in the UK
- 2 year product guarantee



## WeatherShield Magnetic Showcase

### Code

742(w) X 555mm(h)	7221
560(w) X 735mm(h)	7222
1005(w) X 735mm(h)	7223
780(w) X 1031mm(h)	7224
1005(w) X 1031mm(h)	7225
1220(w) X 1031mm(h)	7226
1423(w) X 1031mm(h)	7227

## Colour Options (Frame)



## Writing Board Accessories

Dry Wipe Pens

Size	Code
Pk 4	DMPENSTASS4

Dusters

Size	Code
Single	WBERAS1
Pk 12	WBERAS12

Dry Wipe Pens

Size	Code
Pk 10 Black	DMPENSTBK10
Pk 10 Blue	DMPENSTBU10
Pk 10 Red	DMPENSTRD10
Pk 10 Green	DMPENSTGN10

## WeatherShield Fitting Instructions

- All WeatherShield showcases and signage products are supplied with full fitting instructions.
- Wall mounted WeatherShield products are supplied with wall fixings.
- Surface mounted WeatherShield products are supplied with two brackets that need to be fixed to a preformed concrete base, 600mm deep.
- Sunken post WeatherShield products should be installed in a 600mm deep hole and filled with postcrete.

Installation for WeatherShield showcase and signage products is available separately by quotation. For further information, please contact us on 0845 6017619.

# Fire Retardant Noticeboards

FlameShield is the market leading brand in fire retardant noticeboards.

The FlameShield noticeboard core and bonded textile are fire retardant as a composite, meeting Class 0 when assessed to BS 476 Parts 6 and 7 and comply with Class B-s1, d0 when tested to BS-EN13501-1: 2002.

Within the range we offer three types of noticeboard: unframed, aluminium framed and tamperproof.

The clear plastic doors used in tamperproof FlameShield noticeboards are tested separately, and conform to Class 1Y when assessed to BS 476 Part 7.

There are a variety of colour options to choose from including: primary colours and vibrant tones.

For further information on suitable use of these boards, please see pg. 80.

## FlameShield Contents

	Page
FlameShield Noticeboards	72-73
FlameShield Accents Noticeboards	74-75
FlameShield SmartShield Noticeboards	76-77
FlameShield Premium Showcase	78-79



# Fire Retardant Noticeboards



## FlameShield Unframed Noticeboard

- Noticeboard core and bonded textile are fire retardant as a composite, meeting Class 0 when assessed to BS 476 Parts 6 and 7, and comply with Class B-s1, d0 when tested to BS-EN13501-1: 2002
- Wrapped over edges which are fixed on reverse
- Suitable for pins and staples
- Ideal for portrait or landscape use
- Wall fixings included
- 5 primary colours to choose from
- 2 year product guarantee

FlameShield Unframed Noticeboard	Code
900(w) X 600mm(h)	7306H
1200(w) X 900mm(h)	7309H
1200(w) X 1200mm(h)	7312H
1500(w) X 1200mm(h)	7315H
1800(w) X 600mm(h)	7317H
1800(w) X 1200mm(h)	7318H
2400(w) X 1200mm(h)	7324H



## Colour Options



**NEW**



## FlameShield Aluminium Framed Noticeboard

- Noticeboard core and bonded textile are fire retardant as a composite, meeting Class 0 when assessed to BS 476 Parts 6 and 7, and comply with Class B-s1, d0 when tested to BS-EN13501-1: 2002
- Satin silver anodised aluminium frame
- Rounded safety corners and concealed corner fixing
- Suitable for pins and staples
- Ideal for portrait or landscape use
- Wall fixings included
- 5 primary colours to choose from
- 2 year product guarantee

FlameShield Framed Noticeboard	Code
900(w) X 600mm(h)	4806H
1200(w) X 900mm(h)	4809H
1200(w) X 1200mm(h)	4812H
1500(w) X 1200mm(h)	4815H
1800(w) X 1200mm(h)	4818H
2400(w) X 1200mm(h)	4824H

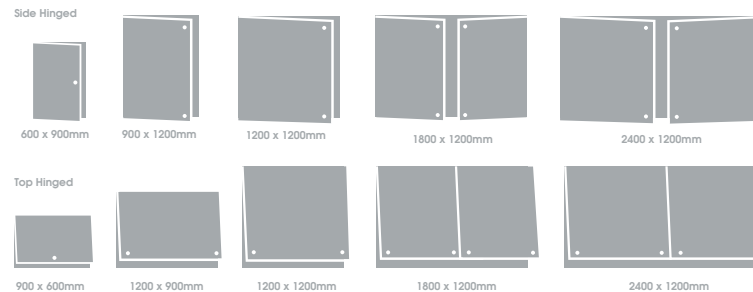

## FlameShield Tamperproof Noticeboard

- Noticeboard core and bonded textile are fire retardant as a composite, meeting Class 0 when assessed to BS 476 Parts 6 and 7, and comply with Class B-s1, d0 when tested to BS-EN13501-1: 2002
- The clear plastic doors are tested separately and conform to Class 1Y when assessed to BS 476 Part 7
- Satin silver anodised aluminium frame
- Rounded safety corners and concealed corner fixing
- Internal clearance between door and board is 20mm
- Single door models are suitable for portrait or landscape use
- Double door models are suitable for landscape use only
- Top hinged models have stays to hold doors open (landscape use only)
- Wall fixings included
- 5 primary colours to choose from
- 2 year product guarantee



FlameShield Side Hinged Noticeboard	Code
600(w) X 900mm(h)	5006H
900(w) X 1200mm(h)	5009H
1200(w) X 1200mm(h)	5012H
1800(w) X 1200mm(h)	5018H
2400(w) X 1200mm(h)	5024H

FlameShield Top Hinged Noticeboard	Code
900(w) X 600mm(h)	5006TH
1200(w) X 900mm(h)	5009TH
1200(w) X 1200mm(h)	5012TH
1800(w) X 1200mm(h)	5018TH
2400(w) X 1200mm(h)	5024TH





### Safety

FlameShield noticeboards are engineered to last and designed to meet the required standards, as a result you will find they are heavier, robust and more dense than a standard noticeboard.

# Fire Retardant Noticeboards



## Accents FlameShield Unframed Noticeboard

- Noticeboard core and bonded textile are fire retardant as a composite, meeting Class 0 when assessed to BS 476 Parts 6 and 7, and comply with Class B-s1, d0 when tested to BS-EN13501-1: 2002
- Wrapped over edges which are fixed on reverse
- Suitable for pins and staples
- Ideal for portrait or landscape use
- Wall fixings included
- 9 impressive colours to choose from
- 2 year product guarantee

Accents FlameShield Unframed Noticeboard	Code
900(w) X 600mm(h)	7306L
1200(w) X 900mm(h)	7309L
1200(w) X 1200mm(h)	7312L
1500(w) X 1200mm(h)	7315L
1800(w) X 1200mm(h)	7318L
2400(w) X 1200mm(h)	7324L



## Accents FlameShield Aluminium Framed Noticeboard

- Noticeboard core and bonded textile are fire retardant as a composite, meeting Class 0 when assessed to BS 476 Parts 6 and 7, and comply with Class B-s1, d0 when tested to BS-EN13501-1: 2002
- Satin silver anodised aluminium frame
- Rounded safety corners and concealed corner fixing
- Suitable for pins and staples
- Ideal for portrait or landscape use
- Wall fixings included
- 9 impressive colours to choose from
- 2 year product guarantee

Accents FlameShield Framed Noticeboard	Code
900(w) X 600mm(h)	4806L
1200(w) X 900mm(h)	4809L
1200(w) X 1200mm(h)	4812L
1500(w) X 1200mm(h)	4815L
1800(w) X 1200mm(h)	4818L
2400(w) X 1200mm(h)	4824L



## Accents FlameShield Tamperproof Noticeboard

- Noticeboard core and bonded textile are fire retardant as a composite, meeting Class 0 when assessed to BS 476 Parts 6 and 7, and comply with Class B-s1, d0 when tested to BS-EN13501-1: 2002
- The clear plastic doors are tested separately and conform to Class 1Y when assessed to BS 476 Part 7
- Satin silver anodised aluminium frame
- Rounded safety corners and concealed corner fixing
- Internal clearance between door and board is 20mm
- Single door models are suitable for portrait or landscape use
- Double door models are suitable for landscape use only
- Top hinged models have stays to hold doors open (landscape use only)
- Wall fixings included
- 9 impressive colours to choose from
- 2 year product guarantee

Accents FlameShield Side Hinged	Code
600(w) X 900mm(h)	5006L
900(w) X 1200mm(h)	5009L
1200(w) X 1200mm(h)	5012L
1800(w) X 1200mm(h)	5018L
2400(w) X 1200mm(h)	5024L

Accents FlameShield Top Hinged	Code
900(w) X 600mm(h)	5006TL
1200(w) X 900mm(h)	5009TL
1200(w) X 1200mm(h)	5012TL
1800(w) X 1200mm(h)	5018TL
2400(w) X 1200mm(h)	5024TL



## Colour Options

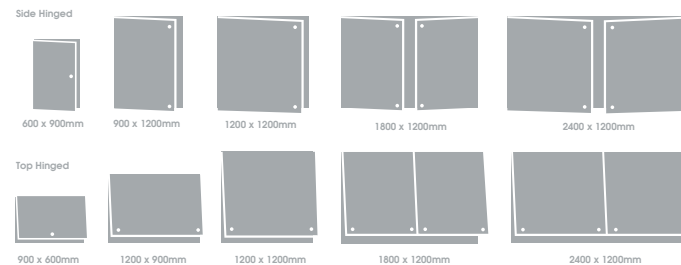
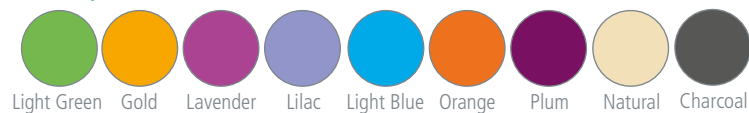



**Impact**  
Accents noticeboards make an impressive impact in any environment and with different styles to choose from, we are sure to have a solution perfect for you.

# Fire Retardant Noticeboards



## SmartShield FlameShield Aluminium Framed Noticeboard

- Noticeboard core and bonded textile are fire retardant as a composite, meeting Class 0 when assessed to BS 476 Parts 6 and 7, and comply with Class B-s1, d0 when tested to BS-EN13501-1: 2002
- Premium aluminium frame
- Contemporary and stylish in design
- Choice of 2 frame colours: aluminium or blue
- Smooth rounded safety corners and concealed corner fixing
- Suitable for pins and staples
- Ideal for portrait or landscape use
- Wall fixings included
- 4 primary board colours to choose from
- 2 year product guarantee



Aluminium Frame



Blue Frame

SmartShield Framed Noticeboard	Code
900(w) X 600mm(h)	4751
1200(w) X 900mm(h)	4752
1200(w) X 1200mm(h)	4753
1500(w) X 1200mm(h)	4754
1800(w) X 1200mm(h)	4755
2400(w) X 1200mm(h)	4756

## Colour Options (Board)

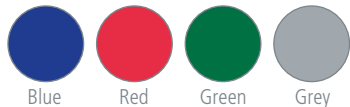

Blue

Red

Green

Grey



## SmartShield FlameShield Tamperproof Noticeboard

- Noticeboard core and bonded textile are fire retardant as a composite, meeting Class 0 when assessed to BS 476 Parts 6 and 7, and comply with Class B-s1, d0 when tested to BS-EN13501-1: 2002
- The clear plastic doors are tested separately and conform to Class 1Y when assessed to BS 476 Part 7
- Premium aluminium frame
- Contemporary and stylish in design
- Choice of 2 frame colours: aluminium or blue
- Smooth rounded safety corners and concealed corner fixing
- Internal clearance between door and board is 20mm
- Single door models are suitable for portrait or landscape use
- Double door models are suitable for landscape use only
- Wall fixings included
- 4 primary board colours to choose from
- 2 year product guarantee



Aluminium Frame



Blue Frame

SmartShield Tamperproof Noticeboard	Code
600(w) X 900mm(h)	4761
900(w) X 1200mm(h)	4762
1200(w) X 1200mm(h)	4763
1800(w) X 1200mm(h)	4765
2400(w) X 1200mm(h)	4766



## Side Hinged

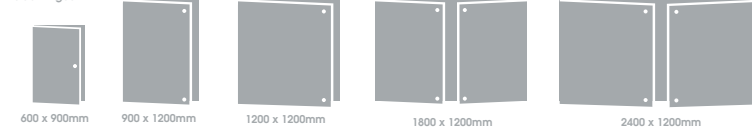



### Premium

SmartShield noticeboards are contemporary and stylish in design with a smooth, premium frame finish. Perfect for displaying information and notices in a modern and professional manner.

# Fire Retardant Noticeboards



## Premium Internal Showcase

- Superior quality internal showcase for displaying notices, information or pupils' work
- Noticeboard core and bonded textile are fire retardant as a composite, meeting Class 0 when assessed to BS 476 Parts 6 and 7, and comply with Class B-s1, d0 when tested to BS-EN13501-1: 2002
- The clear plastic doors are tested separately and conform to Class 1Y when assessed to BS 476 Part 7
- Safe and secure double locking system
- Features gas strut assisted doors
- 5 colour options to choose from
- Wall fixings included
- Made in the UK
- 2 year product guarantee

Premium Internal Showcase	Code
1005(w) X 735mm(h)	7110
780(w) X 1031mm(h)	7111
1005(w) X 1031mm(h)	7112
1220(w) X 1031mm(h)	7113
1423(w) X 1031mm(h)	7114

## Colour Options (Frame and Felt)



Mix and match colour options are available on a non-refundable basis

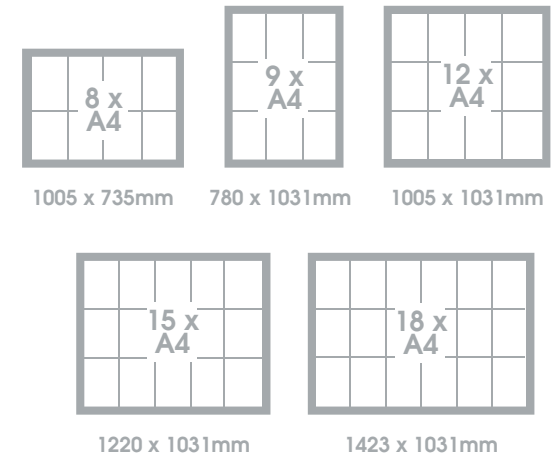

For fire regulations information please see page 84.



**Early Years**  
Ready for nursery?

If your child turns three during 2022 or in February 2023 they will be eligible for two hours of free early learning and child care at nursery. Some children aged two are also eligible, depending on your circumstances.

Applications for 'free' early ed should be submitted between: 01 January – 31 February 2022\*

To find out more about when your child becomes eligible, what choices you have for which nursery they attend visit [www.norfolk.gov.uk](http://www.norfolk.gov.uk)

- Go online at [www.norfolk.gov.uk](http://www.norfolk.gov.uk)
- Call 01603 623 430
- Pick up a leaflet at any East Angles Community School, Library or Community Hub.

To find out more about our other facilities and choose the services that will suit your family visit [www.norfolk.gov.uk](http://www.norfolk.gov.uk)

\* Applications for early ed should be submitted between: 01 January – 31 February 2022

**LEARN SOCIAL**  
**WHAT'S ON?**

TUESDAY	Don't Garden 8-8:30pm
WEDNESDAY	Irish Dancing Evening Grand Social Pubs - 8pm
THURSDAY	National Museum of Ireland Walk - 12pm - All welcome!
FRIDAY	Friday Football - 8pm - 11
SATURDAY	Gifted Mothership - 6:20 West at 8.15pm
SUNDAY	Steam Sports Club logans in Phoenix Park - 12pm

## Fire Retardant Noticeboards

The consequence of fire spread within circulation and escape routes presents a high risk to the building occupants. Materials and items on the walls of these areas should not propagate or accelerate a fire, therefore allowing the occupants the opportunity to exit safely. It is recommended that noticeboards used in these areas should be fire retardant.

**FlameShield** noticeboards are manufactured in the UK by Spaceright Europe Ltd.

The **FlameShield** noticeboard core and bonded textile are fire retardant as a composite, meeting **Class 0** when assessed to **BS 476 Parts 6 and 7** and comply with **Class B-s1, d0** when tested to **BS-EN13501-1: 2002**. The clear plastic doors used in tamperproof **FlameShield** noticeboards are tested separately, and conform to **Class 1Y** when assessed to **BS 476 part 7**.

**FlameShield** noticeboards are engineered to last and designed to meet the required standards, as a result you will find they are heavier, robust and more dense than a standard noticeboard.

Building owners may need to regularly review the fire risks in their premises to comply with their national regulations. Part of that review should consider the type and extent of noticeboard installed, the management of its use, the location of the noticeboard with respect to escape routes, and the other fire safety precautions within the building. Documents related to fire safety risk assessments can be found at:

<https://www.gov.uk/government/collections/fire-safety-law-and-guidance-documents-for-business> for example.





# Noticeboards

Displaying internal notices and information to staff, pupils and visitors requires an effective approach.

Our range of noticeboards offers versatility and style, with a variety of sizes, colour options and designs to choose from. In addition to our large selection of textile noticeboards with varying frame options, such as aluminium or solid wood, we also offer printed noticeboards in the form of our Pin Panelz range.

Pin Panelz is a unique concept in noticeboards and can be personalised to feature your school, college, club or business name.

All of our noticeboards are manufactured to a high standard and are supplied with wall fixings where applicable. Mobile boards feature locking castors and a stability bar.

## Noticeboard Contents

	Page
Noticeboards	86-91
Eco Noticeboards	92-95
Pin Panelz® Noticeboards	96-97
Specialist Noticeboards	98-100



# Noticeboards



## Unframed Noticeboard

- Felt fabric cover
- Wrapped over edges which are fixed on reverse
- Boards can be butted together to form large display surface
- Suitable for pins and staples
- Ideal for portrait or landscape use
- Wall fixings included
- 4 colours to choose from
- 2 year product guarantee

Unframed Noticeboard	Code
900(w) X 600mm(h)	2206
1200(w) X 900mm(h)	2209
1200(w) X 1200mm(h)	2212
1500(w) X 1200mm(h)	2215
1800(w) X 1200mm(h)	2218
2400(w) X 1200mm(h)	2224



## Aluminium Framed Noticeboard

- Satin silver anodised aluminium frame
- Felt fabric cover or cork
- Rounded safety corners and concealed corner fixing
- Suitable for pins and staples
- Ideal for portrait or landscape use
- Wall fixings included
- 5 colours to choose from
- 2 year product guarantee

Aluminium Framed Noticeboard	Code
900(w) X 600mm(h)	7506
1200(w) X 900mm(h)	7509
1200(w) X 1200mm(h)	7512
1500(w) X 1200mm(h)	7515
1800(w) X 1200mm(h)	7518
2400(w) X 1200mm(h)	7524



## Tamperproof Noticeboard

- Locking doors are virtually shatterproof PETG
- Satin silver anodised aluminium frame
- Felt fabric cover or cork
- Rounded safety corners and concealed corner fixing
- Internal clearance between door and board is 20mm
- Single door models are suitable for portrait or landscape use
- Double door models are suitable for landscape use only
- Top hinged models have stays to hold doors open (landscape use only)
- Suitable for pins and staples
- Wall fixings included
- 5 colours to choose from
- 2 year product guarantee



Side Hinged Tamperproof Noticeboard	Code
600(w) X 900mm(h)	7906
900(w) X 1200mm(h)	7909
1200(w) X 1200mm(h)	7912
1800(w) X 1200mm(h)	7918
2400(w) X 1200mm(h)	7924

Top Hinged Tamperproof Noticeboard	Code
900(w) X 600mm(h)	7906T
1200(w) X 900mm(h)	7909T
1200(w) X 1200mm(h)	7912T
1800(w) X 1200mm(h)	7918T
2400(w) X 1200mm(h)	7924T



## Colour Options

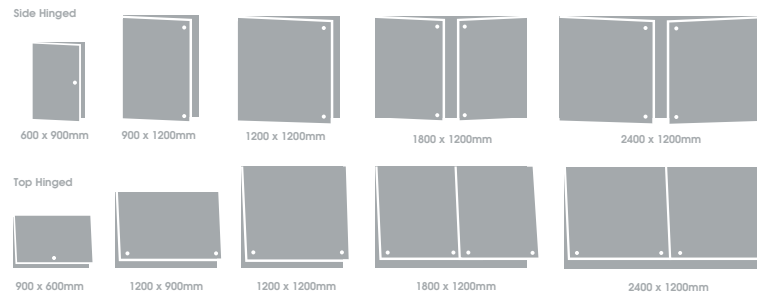



### Mobile Noticeboard

- Double-sided mobile noticeboard
- Satin silver anodised aluminium frame
- Felt fabric cover
- Mobile stand features locking castors and stability bar
- Height adjustable by 210mm
- Panels are freestanding and can be butted together
- Suitable for pins and staples
- Easy to assemble
- 4 primary colours to choose from
- 2 year product guarantee



#### Mobile Noticeboard

#### Code

900(w) X 1200mm(h) Portrait	1654P
1200(w) X 900mm(h) Landscape	1654L
1200(w) X 1200mm(h)	1655
1200(w) X 1500mm(h) Portrait	1657P
1500(w) X 1200mm(h) Landscape	1657L
1800(w) X 1200mm(h) Landscape	1659L



### Display

Mobile noticeboards are handy for creating temporary display areas, whether that be for a parents' evening or an open day. Multiple panels can be butted together to create a larger display area.

# Noticeboards



## Accents Unframed Noticeboard

- Felt fabric cover
- Wrapped over edges which are fixed on reverse
- Boards can be butted together to form large display surface
- Suitable for pins and staples
- Ideal for portrait or landscape use
- Wall fixings included
- 9 impressive colours to choose from
- 2 year product guarantee

Accents Unframed Noticeboard	Code
900(w) X 600mm(h)	8351
1200(w) X 900mm(h)	8352
1200(w) X 1200mm(h)	8353
1500(w) X 1200mm(h)	8354
1800(w) X 1200mm(h)	8355
2400(w) X 1200mm(h)	8356



## Accents Aluminium Framed Noticeboard

- Satin silver anodised aluminium frame
- Felt fabric cover
- Rounded safety corners and concealed corner fixing
- Suitable for pins and staples
- Ideal for portrait or landscape use
- Wall fixings included
- 9 impressive colours to choose from
- 2 year product guarantee

Accents Aluminium Framed Noticeboard	Code
900(w) X 600mm(h)	8306
1200(w) X 900mm(h)	8309
1200(w) X 1200mm(h)	8312
1500(w) X 1200mm(h)	8315
1800(w) X 1200mm(h)	8318
2400(w) X 1200mm(h)	8324



## Accents Tamperproof Noticeboard

- Locking doors are virtually shatterproof PETG
- Satin silver anodised aluminium frame
- Felt fabric cover
- Rounded safety corners and concealed corner fixing
- Internal clearance between door and board is 20mm
- Single door models are suitable for portrait or landscape use
- Double door models are suitable for landscape use only
- Top hinged models have stays to hold doors open (landscape use only)
- Suitable for pins and staples
- Wall fixings included
- 9 impressive colours to choose from
- 2 year product guarantee



Accents Side Hinged Tamperproof	Code
600(w) X 900mm(h)	8406
900(w) X 1200mm(h)	8409
1200(w) X 1200mm(h)	8412
1800(w) X 1200mm(h)	8418
2400(w) X 1200mm(h)	8424

Accents Top Hinged Tamperproof	Code
900(w) X 600mm(h)	8406T
1200(w) X 900mm(h)	8409T
1200(w) X 1200mm(h)	8412T
1800(w) X 1200mm(h)	8418T
2400(w) X 1200mm(h)	8424T



## Colour Options

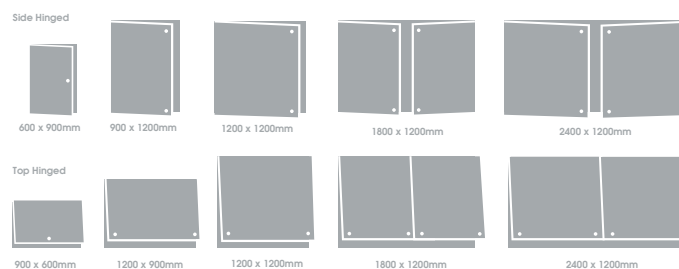
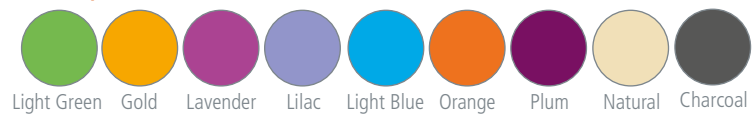



#### Accents Mobile Noticeboard

- Double-sided mobile noticeboard
- Satin silver anodised aluminium frame
- Felt fabric cover
- Mobile stand features locking castors and stability bar
- Height adjustable by 210mm
- Panels are freestanding and can be butted together
- Suitable for pins and staples
- Easy to assemble
- 9 impressive colours to choose from
- 2 year product guarantee



#### Accents Mobile Noticeboard

#### Code

900(w) X 1200mm(h) Portrait	8362P
1200(w) X 900mm(h) Landscape	8362L
1200(w) X 1200mm(h)	8363
1200(w) X 1500mm(h) Portrait	8364P
1500(w) X 1200mm(h) Landscape	8364L
1800(w) X 1200mm(h) Landscape	8365L



#### Bold

Make a bold statement with the Accents noticeboard range. The impressive colours bring a modern feel and fresh look to any office or education environment.

# Noticeboards



Aluminium Frame



Blue Frame

## SmartShield Aluminium Framed Noticeboard

- Premium aluminium framed board
- Contemporary and stylish in design
- Felt fabric cover
- Choice of 2 frame colours: aluminium or blue
- Smooth rounded safety corners and concealed corner fixing
- Suitable for pins and staples
- Ideal for portrait or landscape use
- Wall fixings included
- 4 primary board colours to choose from
- 2 year product guarantee

SmartShield Framed Noticeboard	Code
900(w) X 600mm(h)	4711
1200(w) X 900mm(h)	4712
1200(w) X 1200mm(h)	4713
1500(w) X 1200mm(h)	4714
1800(w) X 1200mm(h)	4715
2400(w) X 1200mm(h)	4716



## Colour Options

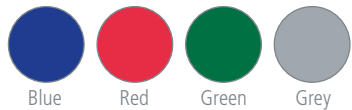

Aluminium Frame



Blue Frame

## SmartShield Tamperproof Noticeboard

- Premium tamperproof board
- Contemporary and stylish in design
- Locking doors are virtually shatterproof PETG
- Choice of 2 frame colours: aluminium or blue
- Felt fabric cover
- Smooth rounded safety corners and concealed corner fixing
- Internal clearance between door and board is 20mm
- Single door models are suitable for portrait or landscape use
- Double door models are suitable for landscape use only
- Suitable for pins and staples
- Wall fixings included
- 4 primary board colours to choose from
- 2 year product guarantee



SmartShield Tamperproof Noticeboard	Code
600(w) X 900mm(h)	4721
900(w) X 1200mm(h)	4722
1200(w) X 1200mm(h)	4723
1800(w) X 1200mm(h)	4725
2400(w) X 1200mm(h)	4726

Side Hinged

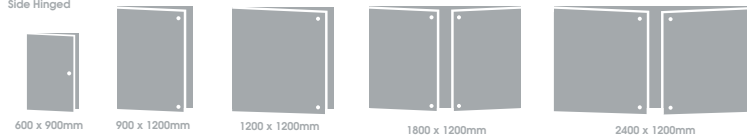

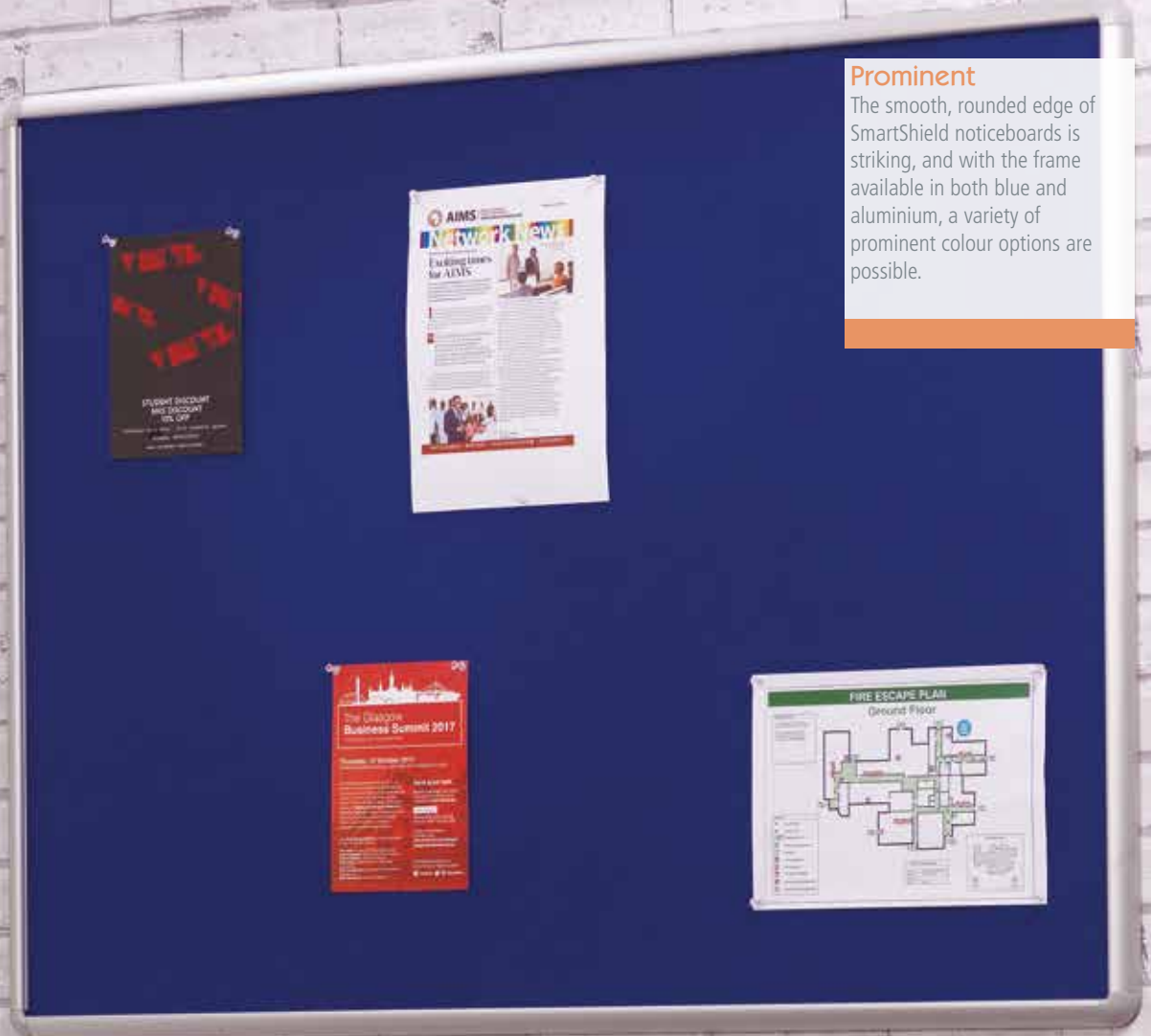

### Prominent

The smooth, rounded edge of SmartShield noticeboards is striking, and with the frame available in both blue and aluminium, a variety of prominent colour options are possible.

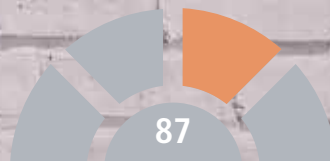

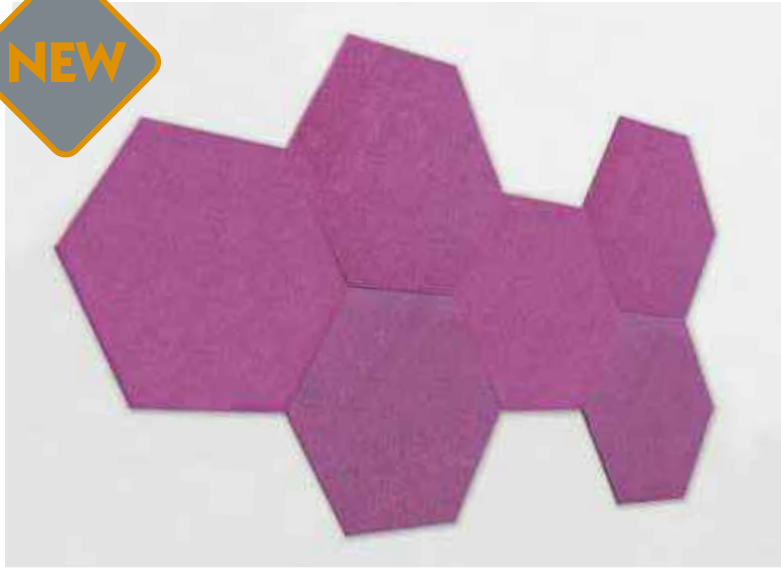

## Bottle Boards

- Eco-friendly hexagonal noticeboards
- Made from 100% polyester fibre with a minimum 75% recycled material (from plastic bottles)
- Lightweight with sound absorbing properties
- Safe, non-toxic and non-allergenic
- Suitable for pins and staples
- Ideal for educational and office environments
- Various configurations possible
- Wall fixings included
- 6 colours to choose from
- Pack of 6 (same colour)
- 1 year product guarantee

### Bottle Boards (Pack of 6)

600(w) X 515mm(h)

### Code

2104/06



Possible configurations with bottle boards (pack of 6):  
Overall dimensions shown

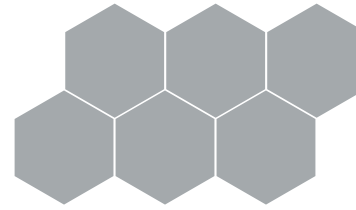

1802(w) x 1050mm(h)

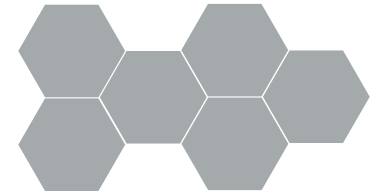

2100(w) x 1030mm(h)

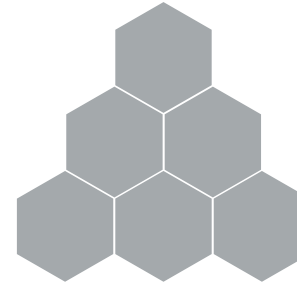

1545(w) x 1500mm(h)



1545(w) x 1500mm(h)



3000(w) x 772mm(h)



1050(w) x 1802mm(h)



1545(w) x 1200mm(h)



1545(w) x 1500mm(h)

## Colour Options







### Eco-friendly

Bottle Boards are an eco-friendly display solution, which can be used to bring colour and style to the interior of any office, school, college or university.

Various configurations are possible for added versatility.

# Noticeboards



## Eco Combination Board

- Environmentally friendly combination noticeboard
- Felt noticeboard / non-magnetic dry wipe
- Constructed from a high proportion of recycled material
- Wood effect beech frame
- Landscape orientation
- Wall fixings included
- 4 board colours to choose from
- 2 year product guarantee



Eco Combination Board	Code
900(w) X 600mm(h)	1860
1200(w) X 900mm(h)	1861
1200(w) X 1200mm(h)	1859
1500(w) X 1200mm(h)	1864
1800(w) X 1200mm(h)	1862
2400(w) X 1200mm(h)	1863



## Eco Noticeboard

- Environmentally friendly noticeboard
- Constructed from a high proportion of recycled material
- Felt fabric cover
- Wood effect beech frame
- Suitable for pins and staples
- Ideal for portrait or landscape use
- Wall fixings included
- 4 board colours to choose from
- 2 year product guarantee

Eco Noticeboard	Code
900(w) X 600mm(h)	1840
1200(w) X 900mm(h)	1841
1200(w) X 1200mm(h)	1842
1500(w) X 1200mm(h)	1843
1800(w) X 1200mm(h)	1844
2400(w) X 1200mm(h)	1845



## Eco Tamperproof Noticeboard

- Environmentally friendly tamperproof noticeboard
- Wood effect beech frame
- Felt fabric cover
- Virtually shatterproof plastic locking door
- Single door model
- Suitable for pins and staples
- Ideal for portrait or landscape use
- Wall fixings included
- 4 colours to choose from
- 2 year product guarantee



Eco Tamperproof Noticeboard	Code
600(w) X 900mm(h)	1865
900(w) X 1200mm(h)	1866

## Colour Options

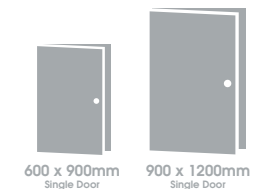
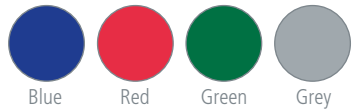



### Solid Wood Tamperproof Noticeboard

- Solid beech tamperproof noticeboard
- Handcrafted using wood from sustainable, managed sources
- Felt fabric cover
- Virtually shatterproof plastic locking door
- Internal clearance 50mm
- Single door model 600(w)x900mm(h) is suitable for portrait or landscape use
- Suitable for pins and staples
- Wall fixings included
- 4 colours to choose from
- 2 year product guarantee



Solid Wood Tamperproof Noticeboard	Code
600(w) X 900mm(h)	4400
900(w) X 1200mm(h)	4401
1200(w) X 1200mm(h)	4402
1500(w) X 1000mm(h)	4403



600 x 900mm  
Single Door

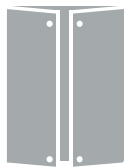

900 x 1200mm  
Twin Door



1200 x 1200mm  
Twin Door

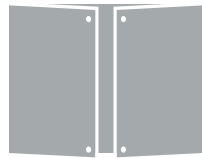

1500 x 1000mm  
Twin Door



### Sustainable

Within our eco-friendly range, this handcrafted solid wood tamperproof noticeboard stands out for its high quality construction. Made using wood from sustainable, managed resources.

# Noticeboards



## Pin Panelz Pantone Noticeboard

- Bold, colourful and stylish printed noticeboards
- Modern way to display information and notices
- Suitable for pins and Blu-Tack (pin holes are not self sealing)
- Fully recyclable
- Chrome wall fixings included
- Choose from a large selection of pantone colours
- 1 year product guarantee

Pin Panelz Pantone Noticeboard	Code
900(w) X 900mm(h)	PP09P***
1200(w) X 1200mm(h)	PP12P***



## Pin Panelz Personalised Noticeboard

- Personalise your display with Pin Panelz
- Panels can be printed with your business/institution name, logo or crest, in a colour of your choice
- Suitable for pins and Blu-Tack (pin holes are not self sealing)
- Fully recyclable
- Chrome wall fixings included
- Choose from a large selection of pantone colours
- 1 year product guarantee



Personalised Pin Panelz	Code
900(w) X 900mm(h)	SPPP09***
1200(w) X 1200mm(h)	SPPP12***



## Pin Panelz Primary Noticeboard

- Bold, colourful printed noticeboards with wave border
- Perfect backdrop for displaying work or notices
- Suitable for pins and Blu-Tack (pin holes are not self sealing)
- Fully recyclable
- Chrome wall fixings included
- 9 colourful boards to choose from
- 1 year product guarantee

Pin Panelz Primary Noticeboard	Code
900(w) X 900mm(h)	PP09PRIM***
1200(w) X 1200mm(h)	PP12PRIM***



## Colour Options (Pantone CMYK)

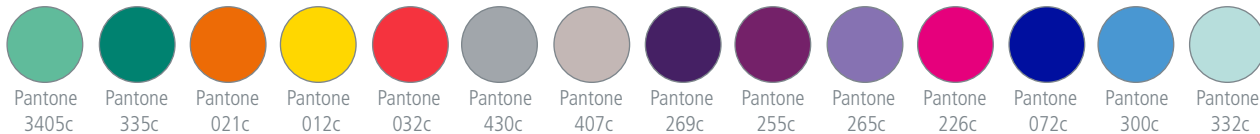

Other pantone CMYK colours are available upon request

## Colour Options (Primary CMYK)

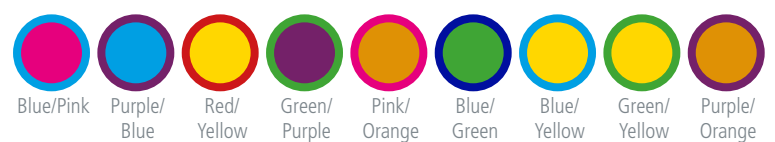

Pin Panelz is a unique concept in noticeboards. Vibrant, colourful and stylish, Pin Panelz provide a modern and fresh approach to displaying information which will enhance your environment.

Unlike standard noticeboards, Pin Panelz are printed which means the choice of colours is almost limitless. We have selected 14 of the most popular colours for the Pin Panelz Pantone range, however other colours are available, so if you need a specific colour to match your corporate identity or school crest, please get in touch.



### Personalisation

Pin Panelz can be personalised with your business/institution name, logo or crest, in a colour of your choice. Simply select the personalised Pin Panelz option, size and colour required, then place your order. We will then contact you to confirm the details and request any artwork you may have. A proof will be supplied prior to print and the lead time is 4 weeks from artwork approval. If at any point you have any queries, don't hesitate to contact us on 0845 6017619.

**Please note all personalised Pin Panelz are non-returnable.**



### Colourful

Bold, colourful and stylish, Pin Panelz provide a more modern way to enhance your display or work space. More versatile than a standard noticeboard, Pin Panelz don't just accept pins, they also accept Blu-Tack.



# Noticeboards



## Dual Pinup Pen Boards

- Combination noticeboard
- Felt noticeboard / non-magnetic dry wipe
- Satin silver anodised aluminium frame
- Rounded safety corners and concealed corner fixing
- Wall fixings included
- 4 colours to choose from
- 2 year product guarantee

Dual Pinup Pen Boards	Code
900(w) X 600mm(h)	0406
1200(w) X 900mm(h)	0409
1200(w) X 1200mm(h)	0412
1500(w) X 1200mm(h)	0415
1800(w) X 1200mm(h)	0418
2400(w) X 1200mm(h)	0424



## Tamperproof Pinup Pen Boards

- Tamperproof combination noticeboard
- Felt noticeboard / non-magnetic dry wipe
- Satin silver anodised aluminium frame
- Locking doors are virtually shatterproof PETG
- Internal clearance between door and board is 20mm
- Rounded safety corners and concealed corner fixing
- Wall fixings included
- 4 colours to choose from
- 2 year product guarantee



Tamperproof Pinup Pen Boards	Code
900(w) X 600mm(h)	0506
1200(w) X 900mm(h)	0509
1200(w) X 1200mm(h)	0512
1800(w) X 1200mm(h)	0518
2400(w) X 1200mm(h)	0524



## Mobile Pinup Pen Boards

- Double-sided combination mobile noticeboard
- Felt noticeboard / non-magnetic dry wipe
- Satin silver anodised aluminium frame
- Mobile stand features locking castors and stability bar
- Height adjustable by 210mm
- Panels are freestanding and can be butted together
- Suitable for pins and staples
- Easy to assemble
- 4 colours to choose from
- 2 year product guarantee



Mobile Pinup Pen Boards	Code
1200(w) X 900mm(h)	1909
1200(w) X 1200mm(h)	1912
1500(w) X 1200mm(h)	1915
1800(w) X 1200mm(h)	1918

## Colour Options



## Writing Board Accessories



Dry Wipe Pens

Size	Code
Pk 4	DMPENSTASS4



Dusters

Size	Code
Single	WBERAS1
Pk12	WBERAS12



Dry Wipe Pens

Size	Code
Pk10 Black	DMPENSTBK10
Pk10 Blue	DMPENSTBU10
Pk10 Red	DMPENSTRD10
Pk10 Green	DMPENSTGN10



Board Cleaner

Size	Code
250ml Spray	DWS.25
1.0lt Bottle	DWC1
2.5lt Bottle	DWC2.5



#### Safety Sliding Door Noticeboard

- Locking noticeboard engineered for safety
- Sliding doors are virtually shatterproof
- White powder coated aluminium casing
- Tamperproof design for secure display
- Internal clearance between door and board surface is 20mm
- Suitable for pins and staples
- Wall fixings included
- 4 board colours to choose from
- 2 year product guarantee



#### Safety Sliding Door Noticeboard

	Code
1200(w) X 1200mm(h)	2712
1800(w) X 1200mm(h)	2718
2400(w) X 1200mm(h)	2725



Sliding detail



#### Engineered

For secure display of information, the sliding noticeboard is the ultimate solution. Featuring an impressive white aluminium frame, this noticeboard was engineered for safety and built to last.

# Noticeboards



## Mobile Flip Chart Noticeboard Combi

- Double-sided combination mobile noticeboard
- Felt noticeboard on one side, magnetic dry wipe on reverse
- Satin silver anodised aluminium frame
- Mobile stand features locking castors and stability bar
- Pen ledge and flip chart clamp on dry wipe side
- Flip chart clamp (holds pads up to A1 size)
- Noticeboard suitable for pins and staples
- Panels are freestanding and can be butted together
- 4 colours to choose from
- 2 year product guarantee

Mobile Flip Chart Noticeboard Combi	Code
1200(w) X 900mm(h)	1640
1200(w) X 1200mm(h)	1641
1800(w) X 1200mm(h)	1643

## Colour Options

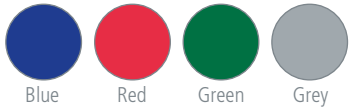

Blue

Red

Green

Grey





# Display & Presentation

Within schools, universities and businesses, there is often a requirement, not only to display notices and information, but to introduce key personnel, present literature and showcase awards.

We have a comprehensive range of products for doing all of that and more. From leaflet holders and trophy showcases, to poster display frames and leaflet dispensers, we have a solution whatever your requirements may be.

Crystal Wall display boards provide a fresh and modern approach to presenting key staff, pupils or team information to visitors, whilst our Colourama leaflet and brochure dispensers are designed to be durable and practical, with a range of soft pastel colours to choose from.

## Display & Presentation Contents

	Page
Crystal Wall Display Frames	98-101
Trophy Cabinets and Showcases	102-103
Poster Display Frames	104-105
Leaflet Dispensers	106-108



# Display & Presentation



## Crystal Wall Staff / Class Board

- Professional way to present staff or class pupils
- Simply print required pictures and slot into the pockets
- Board is made from 6mm virtually shatterproof PETG
- Pocket size 60(w) x 82mm(h)
- Pockets are self closing and re-useable
- Chrome stand off fixings supplied
- Depth including wall fixings is 30mm
- Optional nameplate board available
- 1 year product guarantee

9 pockets	Code
320(w) X 386mm(h)	CWSB01
20 pockets	Code
415(w) X 620mm(h)	CWSB02
35 pockets	Code
720(w) X 620mm(h)	CWSB03

## Crystal Wall Staff / Class Board (6 pockets)

- Professional way to present staff or class pupils
- Simply print required pictures and slot into the pockets
- Board is made from 6mm virtually shatterproof PETG
- Pockets are self closing and re-useable
- Chrome stand off fixings supplied
- Depth including wall fixings is 30mm
- Optional nameplate board available
- 1 year product guarantee

**NEW**

6 pockets (60(w) x 82mm(h) each)	Code
180(w) X 320mm(h)	CWPB02
6 pockets (90(w) x 132mm(h) each)	Code
250(w) X 450mm(h)	CWPB01

## Crystal Wall Notice Frame (12 pockets)

- Slick and professional way to display signs and notices
- Board is made from 6mm virtually shatterproof PETG
- Pocket sizes 6 x A4 and 6 x 90(w) x 130mm(h)
- Pockets are self closing and re-useable
- Chrome stand off fixings supplied
- Depth including wall fixings is 30mm
- 1 year product guarantee

**NEW**

Crystal Wall Notice Frame	Code
900(w) X 900mm(h)	CWPB04



Easy Fill Pockets

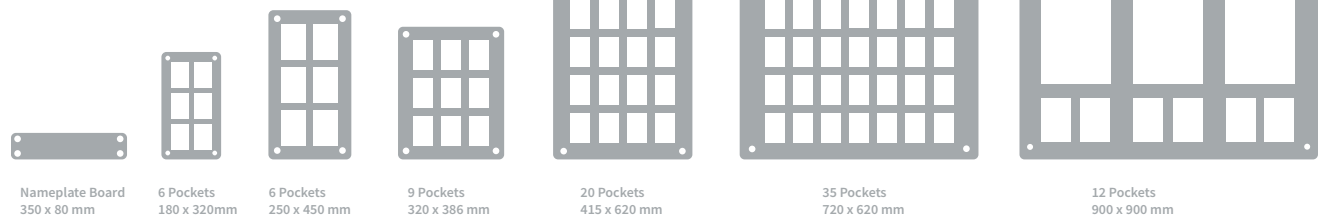

Nameplate Board  
350 x 80 mm

6 Pockets  
180 x 320mm

6 Pockets  
250 x 450 mm

9 Pockets  
320 x 386 mm

20 Pockets  
415 x 620 mm

35 Pockets  
720 x 620 mm

12 Pockets  
900 x 900 mm



### Crystal Wall Team Board

- 20 pocket display board
- Professional way to present teams
- Simply print required pictures and slot into the pockets
- Board is made from 6mm virtually shatterproof PETG
- Pocket size 90(w) x 132mm(h)
- Pockets are self closing and re-useable
- Chrome stand off fixings supplied
- Depth including wall fixings is 30mm
- Optional nameplate board available
- 1 year product guarantee

Crystal Wall Team Board	Code
539(w) X 870mm(h)	CWTB01



### Crystal Wall Nameplate

- Designed to accompany Crystal Wall Staff/Class and Team boards
- Features 2 plates of 3mm virtually shatterproof PETG
- Name slides between plates and is then fixed to wall
- Chrome 30mm stand off fixings supplied
- 1 year product guarantee

Crystal Wall Nameplate	Code
350(w) X 80mm(h)	CWNPB



### Informative

Crystal Wall display boards are a professional and modern way to present staff, class or team information to visitors. The picture pockets are easy to use and information can be changed as required.

# Display & Presentation



## Crystal Wall Notice Frame

- Slick and professional way to display signs and notices
- Designed for A5 and A4 signs
- Features 2 plates of 3mm virtually shatterproof PETG
- Sign/notice slides between plates and is then fixed to wall
- Chrome stand off fixings supplied
- Depth including wall fixings is 30mm
- 1 year product guarantee

### Crystal Wall Notice Frame

A5 - 210(w) X 272mm(h)  
A4 - 272(w) X 359mm(h)

### Code

CWNPBA5  
CWNPBA4



## Crystal Wall School Achievements Board (Landscape)

- An impressive way to display news and achievements
- Simply print required notices and slot into the pockets
- Board is made from 8mm virtually shatterproof PETG
- Pockets quantities/sizes: 7 x A4, 5 x A5 and 3 x 132(h) x 90mm(w)
- Includes personalisation pocket for name
- Pockets are self closing and re-useable
- Chrome stand off fixings supplied
- Depth including wall fixings is 30mm
- 1 year product guarantee

### School Achievements Board Landscape

1200(w) X 900mm(h)

### Code

CWDB01



## Crystal Wall School Achievements Board (Portrait)

- An impressive way to display news and achievements
- Simply print required notices and slot into the pockets
- Board is made from 8mm virtually shatterproof PETG
- Pockets quantities/sizes: 6 x A4, 6 x A5 and 6 x 132(h) x 90mm(w)
- Includes personalisation pocket for name
- Pockets are self closing and re-useable
- Chrome stand off fixings supplied
- Depth including wall fixings is 30mm
- 1 year product guarantee

### School Achievements Board Portrait

900(w) X 1200mm(h)

### Code

CWDB02



Easy Fill Pockets



Personalisation Pocket



Nameplate Board  
350 x 80 mm



A5 Notice Frame  
210 x 272 mm



A4 Notice Frame  
272 x 359 mm

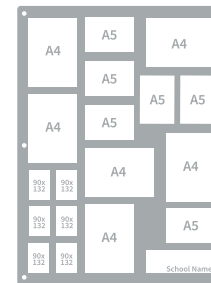

School Bulletin (portrait)  
900 x 1200 mm

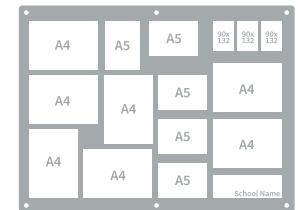

School Bulletin (Landscape)  
1200 x 900 mm

## Modern

Display achievements with pride using these modern and professional boards. Complete with chrome fixings and different sized, re-useable pockets, Crystal Wall is a versatile and easy to use product.



# Display & Presentation



## Wall Mounted Trophy Showcase

- Wall mounted cabinet for displaying trophies and awards
- Features white centre panel with anodised aluminium sides
- Ideal for mounting at eye level for effective display
- No floor space required so ideal for smaller areas
- Secure, locking PETG door
- 2 glass display shelves
- Strong and durable construction
- Heavy duty wall fixings included
- LED light version available with 3 downlights
- 10 year product guarantee

Wall Mounted Trophy Showcase 1200(w) X 1000(h) X 250mm(d)	Code
Without lights	4697
With LED lights	4697/1



## Floor Standing Trophy Showcase

- Prestigious and fitting showpiece to display trophies and awards
- High quality, sturdy, freestanding construction
- Showcase features a white centre panel with anodised aluminium sides
- Ideal for reception areas
- Secure, locking PETG door
- 3 glass display shelves
- LED light option available with 3 uplights and 3 downlights
- Footprint 1200(w) X 250mm(d)
- 10 year product guarantee

Floor Standing Trophy Showcase 1200(w) X 2000(h) X 250mm(d)	Code
Without lights	4696
With LED lights	4696/1



## Personalised Floor Standing Trophy Showcase

- Prestigious and fitting showpiece to display trophies and awards
- High quality, sturdy, freestanding construction
- Showcase features a white centre panel with anodised aluminium sides
- Centre panel is personalised to feature name and/or logo
- Ideal for reception areas
- Secure, locking PETG door
- 3 glass display shelves
- LED light option available with 3 uplights and 3 downlights
- Footprint 1200(w) X 250mm(d)
- 10 year product guarantee

Floor Standing Personalised Trophy Showcase 1200(w) X 2000(h) X 250mm(d)	Code
With graphic, without lights	4698
With graphic and LED lights	4698/1



Showcase internal detail

## Personalisation

The showcase is personalised with your business / institution name, logo or crest. Simply place your order and we will then contact you to confirm the details and request any artwork you may have. A proof will be supplied prior to print and the lead time is 4 weeks from artwork approval. If at any point you have any queries, don't hesitate to contact us on 0845 6017619.

**Please note all personalised trophy showcases are non-returnable.**



### Prestigious

The trophy showcase from Spaceright is a prestigious and fitting showpiece to display your trophies and awards. It's curved, contemporary design and soft lines will enhance your reception area whilst requiring minimal floor space.

# Display & Presentation



Opening Tool



## Poster Display Frame

- Spring loaded mitred poster case
- Snap open and close aluminium frame
- Recommended for indoor use
- Protective UV film
- 6 colour options to choose from
- Wall fixings included
- 1 year product guarantee

Aluminium Poster Display Frames	Code
A4 - 250(w) X 335mm(h)	4198
A3 - 310(w) X 435mm(h)	4197
A2 - 460(w) X 630mm(h)	4196
Poster - 545(w) X 800mm(h)	4192
A1 - 635(w) X 885mm(h)	4195
Poster - 700(w) X 1000mm(h)	4193
A0 - 885(w) X 1225mm(h)	4194

Colour Poster Display Frames	Code
A4 - 250(w) X 335mm(h)	4264
A3 - 310(w) X 435mm(h)	4263
A2 - 460(w) X 630mm(h)	4262
A1 - 635(w) X 885mm(h)	4261
A0 - 885(w) X 1225mm(h)	4260

## Secure Poster Display Frame

- Spring loaded mitred secure poster case
- Snap open and close frame
- Once frame is closed, use tool to re-open
- Opening tool supplied
- Recommended for indoor use
- Protective UV film
- Anodised aluminium
- Wall fixings included
- 1 year product guarantee

Secure Poster Display Frames	Code
A4 - 250(w) X 335mm(h)	4284
A3 - 310(w) X 435mm(h)	4283
A2 - 460(w) X 630mm(h)	4282
A1 - 635(w) X 885mm(h)	4281
A0 - 885(w) X 1225mm(h)	4285

## Tamperproof Poster Display Frame

- Spring loaded mitred tamperproof poster case
- Snap open and close frame
- Frame is locked using allen bolt
- Frame cannot be re-opened without the use of an allen key
- Recommended for indoor use
- Protective UV film
- Anodised aluminium
- Wall fixings included
- 1 year product guarantee



Tamperproof Poster Display Frames	Code
A4 - 250(w) X 335mm(h)	4289
A3 - 310(w) X 435mm(h)	4293
A2 - 460(w) X 630mm(h)	4292
A1 - 635(w) X 885mm(h)	4291
A0 - 885(w) X 1225mm(h)	4290
Poster 20" X 30" - 500(w) X 700mm(h)	4287
Poster 30" X 40" - 700(w) X 1000mm(h)	4288

## Colour Options (Poster Display Frame)

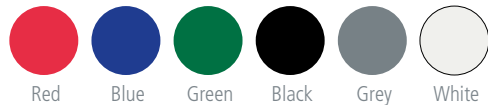

Unlocked

Locked





#### Poster Display A Frame

- Heavy duty aluminium structure
- Snap open and close aluminium frame
- Suitable for outdoor or indoor use
- Front opening 32mm profile
- Galvanised steel backing
- Chrome rounded corners
- Easy assembly
- 1 year product guarantee

#### Poster Display A Frames

#### Code

A2 - 400(w) X 574mm(h)	4021
A1 - 574(w) X 821mm(h)	4022
A0 - 821(w) X 1169mm(h)	4023
Poster 30" X 40" - 700(w) X 1000mm(h)	4020



#### Secure

These single poster display frames are a quick and easy way to present information and notices. Depending on where they are used, the secure and tamperproof options offer added security.

# Display & Presentation



## Eco Friendly Wall Mounted Leaflet Dispenser

- Strong, attractive and practical leaflet dispenser
- Wall mounted design with clear leaflet retainers
- Manufactured in wood from sustainable sources
- Depth from wall 100mm
- Inside pocket depth 15mm
- Easy to install
- Wall fixings supplied
- 4 pastel colours to choose from
- 5 year product guarantee

Wall Mounted Leaflet Dispensers	Code
4 x 1/3A4 - 110(w) X 525(h) X 100mm(d)	4439
4 x A5 - 180(w) X 525(h) X 100mm(d)	4438
3 x A4 - 235(w) X 525(h) X 100mm(d)	4436
6 x A4 - 460(w) X 525(h) X 100mm(d)	4437



## Eco-Friendly Rotating Leaflet / Brochure Dispenser

- Strong, attractive and practical rotating leaflet dispenser
- Manufactured in wood from sustainable sources
- Freestanding on sturdy metal base
- Inside pocket depth 20mm
- Overall height 1511mm
- 4 pastel colours to choose from
- 5 year product guarantee



Freestanding Leaflet Dispensers	Code
12 x A4 - 250(w) X 956(h) X 355mm(d)	4440
18 x A4 - 460(w) X 956(h) X 460mm(d)	4441
24 x A4 - 495(w) X 956(h) X 495mm(d)	4442

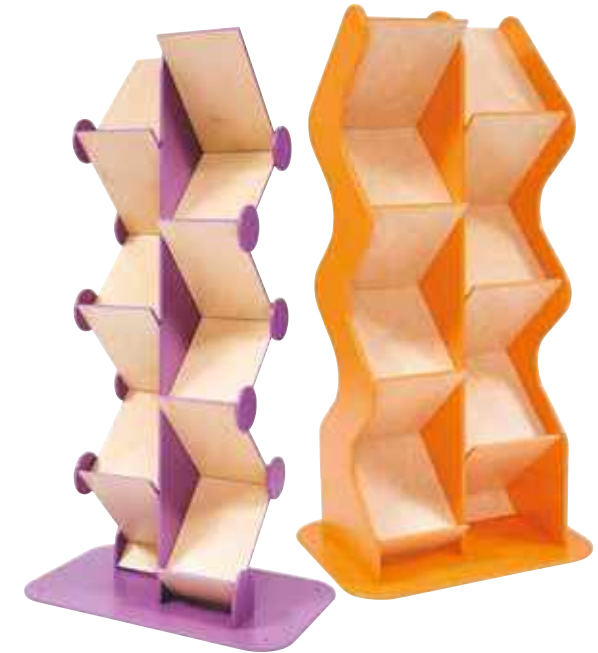

## Freestanding Book / Brochure Dispenser

- Strong, attractive and practical, zig-zag or wave brochure dispensers
- Manufactured in wood from sustainable sources
- Freestanding double-sided book/brochure dispenser
- 12 display locations
- Overall height 1530mm
- Floor fixing kit is supplied (recommended in public areas)
- 4 pastel colours to choose from
- 5 year product guarantee

12 x A4 Zig-Zag	Code
800(w) X 1530(h) X 500mm(d)	4430
12 x A4 Wave	Code
800(w) X 1530(h) X 500mm(d)	4432

## Colour Options

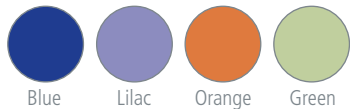



## Strong

Colourama is a range of strong and practical leaflet dispensers, available in four attractive pastel colours. There are various styles to choose from including: wall mounted, rotating or freestanding.



### Crystal Clear Wall Mounted Leaflet Dispenser

- Versatile and contemporary wall mounted leaflet dispenser
- High quality construction with various configurations
- Design maximises leaflet exposure and provides full height support
- High gloss, virtually shatterproof PETG back and sides
- Wall fixings included
- 2 colour options to choose from
- 2 year product guarantee

Wall Mounted Leaflet Dispensers	Code
8 x A4 - 462(w) X 750(h) X 175mm(d)	4530
16 x A4 - 914(w) X 750(h) X 175mm(d)	4531
12 x A5 - 487(w) X 630(h) X 175mm(d)	4532
16 x 1/3A4 - 462(w) X 600(h) X 175mm(d)	4533
6 x A5 - 487(w) X 350(h) X 110mm(d)	4534
12 x 1/3A4 - 688(w) X 350(h) X 110mm(d)	4535
6 and 6 x 1/3A4 - 688(w) X 750(h) X 110mm(d)	4536
6 x A4 - 688(w) X 450(h) X 110mm(d)	4537

## Crystal Clear Dispensers



### Colour Options



4530 - 8 x A4

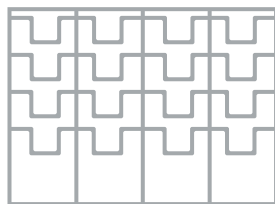

4531 - 16 x A4

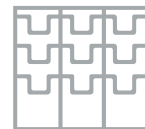

4532 - 12 x A5

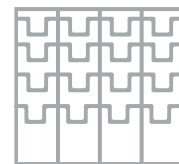

4533 - 16 x 1/3A4



4534 - 6 x A5

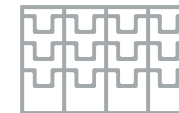

4535 - 12 x 1/3A4

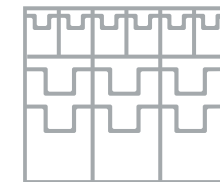

4536 - 6 x A4 & 6 x 1/3A4

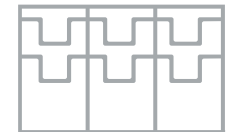

4537 - 6 x A4

# Exhibition & Display Screens

Flexible, easy to use, high quality exhibition and display solutions.

From partition screens to presentation kits, our versatile range of exhibition and display products are multi-purpose and ideally suited to a variety of different environments.

If you're looking to divide a room or a space, we have a great range of products which will enable you to do so in a quick and efficient manner.

Our exhibition systems and kits are ideal for creating a presentation area, whether that be for an open day, parents' evening or trade event.

## Exhibition & Display Contents

	Page
Mobile Display Systems	110-113
Exhibition and Display Panels	114-117
Fold-Up Display / Exhibition Systems	118-119
Exhibition Systems	120



# Exhibition & Display Screens



## Mobile Tri Screen

- Flexible, double-sided, mobile partitioning screen
- Ideal for dividing areas, exhibitions or displaying work
- Lightweight but sturdy structure
- Multiple configurations: straight line, bay, curved or right angle
- 3 panels with flexible gear hinges
- Each panel is 1800mm high
- Covered both sides with felt
- Suitable for pins
- Features locking castors and stability feet
- Folds flat for storage when not in use
- 4 colour options to choose from
- 2 year product guarantee

Mobile Tri Screen	Code
3600(w) X 1900mm(h)	2618

### Colour Options

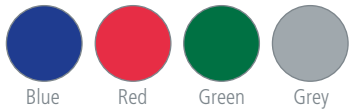

3600 x 1900 mm



Hinge Detail

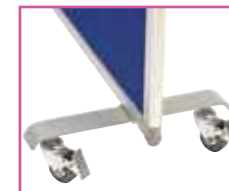

Locking Castors



Folds Flat



### Superior

Tri Screen is a superior exhibition and display product, not only does the sturdy construction make it reliable and easy to use, but the fabric and frame finish are aesthetically pleasing. Perfect for dividing areas, exhibitions or displaying work.



# Exhibition & Display Screens



## Mobile Insta-Wall

- Sound absorbing mobile partitioning
- Ideal for temporary partitioning of large rooms, reception areas and halls
- Fits neatly into its own self contained frame
- Easily folds away when not in use
- Lightweight but sturdy structure is safely and easily operated by one person
- Full length piano hinges connect each panel
- Lockable castors fitted to each panel
- Design ensures the system is completely stable in any position including: straight line, bays, curves or forming right angles
- Individual panel size 600(w) x 1800mm(h)
- Available as 3, 5 or 7 panels
- 3 colour options to choose from
- 2 year product guarantee

### Mobile Insta-Wall

	Code
1800(w) X 1940mm(h) (3 panel System)	2983
3000(w) X 1940mm(h) (5 panel System)	2985
4200(w) X 1940mm(h) (7 panel System)	2987

### Colour Options

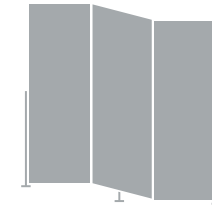
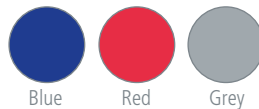

3 Panel 1800 x 1940 mm

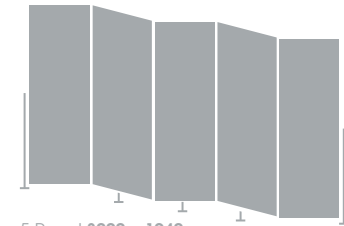

5 Panel 3000 x 1940 mm

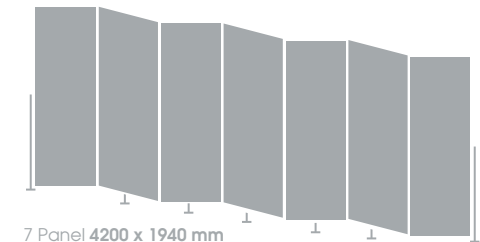

7 Panel 4200 x 1940 mm

Watch the video



Scan the QR code







### Perceptive

The perceptive design of Insta-Wall makes for a flexible and user friendly product. It can be used in a variety of different environments to partition rooms or areas and when not in use, the adjoining panels fold into the frame for efficient storage.



## SpaceDividers

- High quality, floor standing space dividers
- Ideal for dividing classrooms, or separate study areas
- Double-sided fabric cover
- Panels are acoustic and sound absorbing
- Screens are supplied as standard with button feet and a set of 2 foot plates
- Full range of linking options are available as accessories
- Variety of heights and widths available
- Stable and sturdy construction
- 30mm thick partitions
- 11 colours to choose from
- 1 year product guarantee

Standard Panel	Code
900(w) X 1200mm(h)	8100
1000(w) X 1200mm(h)	8101
1200(w) X 1200mm(h)	8102
1500(w) X 1200mm(h)	8103
1600(w) X 1200mm(h)	8104
1800(w) X 1200mm(h)	8105
900(w) X 1500mm(h)	8106
1000(w) X 1500mm(h)	8107
1200(w) X 1500mm(h)	8108
1500(w) X 1500mm(h)	8109
1600(w) X 1500mm(h)	8110
1800(w) X 1500mm(h)	8111
900(w) X 1800mm(h)	8112
1000(w) X 1800mm(h)	8113
1200(w) X 1800mm(h)	8114
1500(w) X 1800mm(h)	8115
1600(w) X 1800mm(h)	8116

Panel Accessories	Code
In Line Link Strip	8130
90° Link Strip	8131
Cross Link Strip	8132
T Foot Plate	8135
Disc Foot Plate	8136



90° Link Strip    Cross Link Strip    In Line Link Strip    Foot Plate



### Colour Options

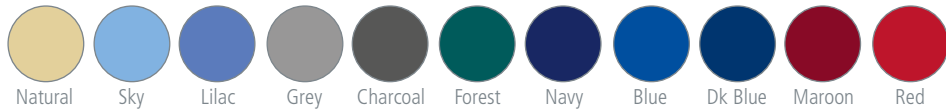

Natural    Sky    Lilac    Grey    Charcoal    Forest    Navy    Blue    Dk Blue    Maroon    Red



Please note all SpaceDividers are made to order and non-returnable.



### Curved SpaceDividers

- Sturdy, floor standing, curved space dividers
- Ideal for dividing classrooms, creating quiet or separate study areas
- Double-sided fabric cover
- Panels are acoustic and sound absorbing
- Screen are supplied as standard with button feet and a set of 2 foot plates
- Corner radius is 100mm
- Stable and sturdy construction
- 30mm thick partitions
- 11 colours to choose from
- 1 year product guarantee

Curved Panel	Code
1000(w) X 900mm(h)	8120
1000(w) X 1200mm(h)	8121
1200(w) X 1200mm(h)	8122
1500(w) X 1200mm(h)	8123
1600(w) X 1200mm(h)	8124
1800(w) X 1600mm(h)	8125



Curved Edge



Foot Plate



### Enhance

Our SpaceDivider collection offers true versatility with a finish which will blend with, and enhance, any surrounding. Both the standard screens and curved screens have an attractive silver edge, and the colour palette will compliment a variety of different environments.

# Exhibition & Display Screens



## Xib-it Pole and Panel Pinboard

- Pole and panel exhibition system with multiple uses
- Single or multiple boards clip together to create your own unique system
- Large aluminium framed panel 1500(w) x 1200mm(h) can be mounted in landscape or portrait format at any height and angle
- Each panel is provided with two poles and bases for side by side use
- Flexible clip system allows the second panel to clip and join directly to the pole of the first panel
- Ultra heavy duty metal bases for additional stability
- Double-sided pin board
- 3 colours to choose from
- 2 year product guarantee



### Xib-it Pinboard

Pinboard / Pinboard

### Code

5245

### Colour Options

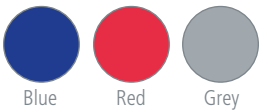

Blue

Red

Grey



## Xib-it Pole and Panel Whiteboard

- Pole and panel exhibition system with multiple uses
- Single or multiple boards clip together to create your own unique system
- Large aluminium framed panel 1200(w) x 1500mm(h) can be mounted in landscape or portrait format at any height and angle
- Each panel is provided with two poles and bases for side by side use
- Flexible clip system allows the second panel to clip and join directly to the pole of the first panel
- Ultra heavy duty metal bases for additional stability
- Double-sided magnetic whiteboard
- 2 year product guarantee



### Xib-it Whiteboard

Whiteboard / Whiteboard

### Code

5246

Possible configurations with Xib-it pinboard and whiteboard panels:

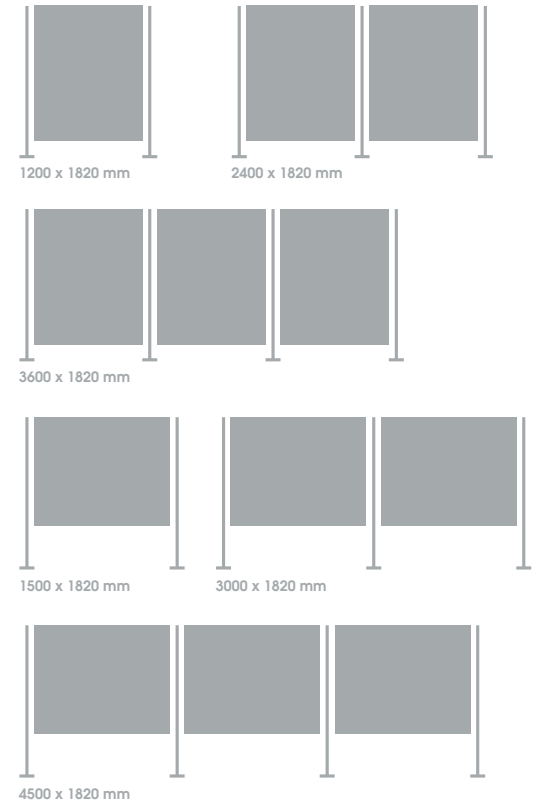

Pole clip



Pole clip insert



Pole clip twist



**Exhibit**  
Xib-it pole and panel boards allow you to create impressive exhibition displays. With a sturdy structure and simple clip system, the panels are easy to use and reconfigure.



# Exhibition & Display Screens

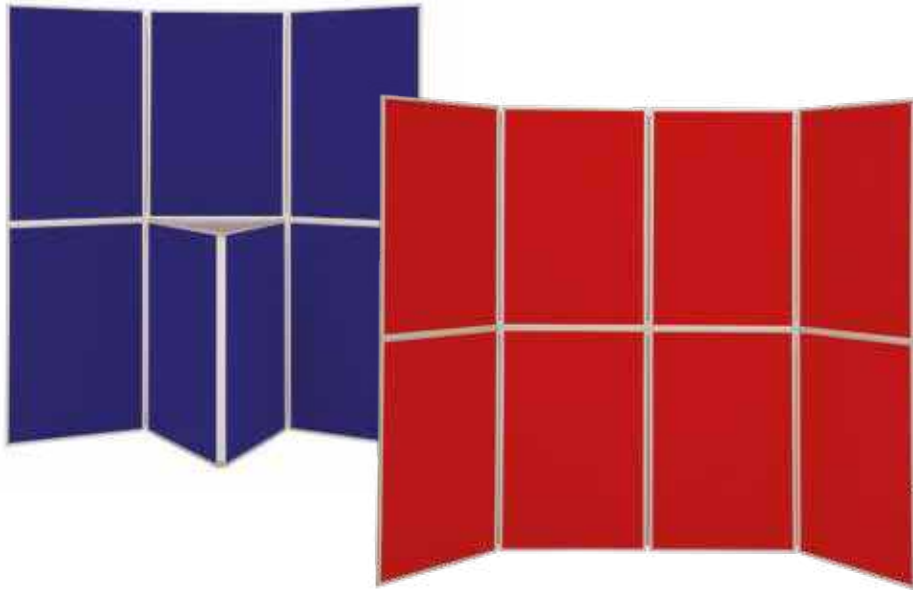

## Lightweight Fold-Up Display Screen

- Fold-up display screen system with lightweight panels
- Double-sided panels are 600(w) x 900mm(h) and hinged together in two sections (except desktop version)
- Easy to fold up, store, transport and erect
- Supplied with heavy-duty zip-up nylon storage and carrying bag
- 3 colours to choose from
- 1 year product guarantee

### Light Weight Fold-Up

	Code
1800(w) X 2050mm(h) (6 panel system)	5126
1800(w) X 2050mm(h) (7 panel system with shelf)	5127
2400(w) X 2050mm(h) (8 panel system)	5128

### Light Weight Fold-Up Portrait Desktop

Main panel size 600 x 900mm, hinged side panels 600 x 900mm, header panel 600 x 250mm.

	Code
1850(w) X 1150mm(h) (4 panel system)	5106

### Light Weight Fold-Up Landscape Desktop

Main panel size 900 x 600mm, hinged side panels 450 x 600mm, detachable header panel 900 x 250mm.

	Code
1850(w) X 850mm(h) (4 panel system)	5110



### Colour Options

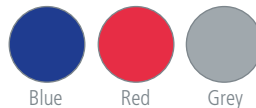

## Heavy Duty Fold-Up Display Screen

- Fold-up display screen system with heavy duty aluminium framed panels
- Double-sided panels are 600(w) x 900mm(h) and hinged together in two sections (except desktop version)
- Easy to fold up, store, transport and erect
- Supplied with heavy-duty zip-up nylon storage and carrying bag
- 3 colours to choose from
- 1 year product guarantee

### Heavy Duty Fold-Up

	Code
1800(w) X 2050mm(h) (6 panel system)	5136
1800(w) X 2050mm(h) (7 panel system with shelf)	5137
2400(w) X 2050mm(h) (8 panel system)	5138

### Heavy Duty Fold-Up Portrait Desktop

Main panel size 600 x 900mm, hinged side panels 600 x 900mm, header panel 600 x 250mm.

	Code
1850(w) X 1150mm(h) (4 panel system)	5135

### Heavy Duty Fold-Up Landscape Desktop

Main panel size 900 x 600mm, hinged side panels 450 x 600mm, detachable header panel 900 x 250mm.

	Code
1850(w) X 850mm(h) (4 panel system)	5134



4 Panel - Landscape  
1800 x 850mm

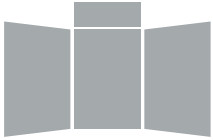

4 Panel - Portrait  
1800 x 1150mm

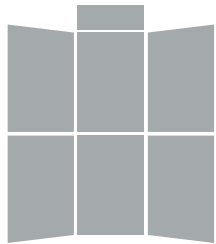

6 Panel - Portrait  
1800 x 2050 mm

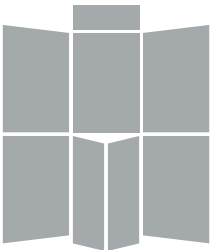

7 Panel - Portrait  
1800 x 2050 mm

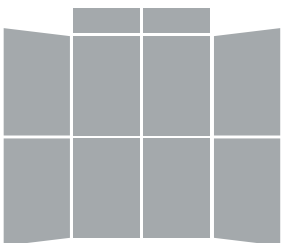

8 Panel - Portrait  
2400 x 2050 mm



### Convenient

Present a professional image at exhibitions and trade events with these handy display screens. Easy to set-up and transport, each one is supplied with a heavy-duty bag for convenient storage after use.



## Gallery Display Systems (40mm thick panels)

- Premium quality, robust display system which is versatile in design
- Use to permanently display work or create a semi-permanent project display
- Lightweight panels are easily portable, stable and suitable for heavy duty use
- Simple to use and quick to assemble
- Panels lock together in seconds with the panel key provided
- Easy to reconfigure for maximum versatility
- Double-sided blue and grey fabric panels (configuration allows for all blue or all grey)
- Dimensions shown below are for straight-line configuration
- 1 year product guarantee

Panel Systems	Code
2 Panel System 1800(w) X 1800mm(h)	5284
3 Panel System 2700(w) X 1800mm(h)	5285
4 Panel System 3600(w) X 1800mm(h)	5286
6 Panel System 5400(w) X 1800mm(h)	5287
Additional Panel 900(w) X 1800mm(h)	5283



2 panel system



3 panel system



4 panel system



6 panel system

Locking side      Grooved side

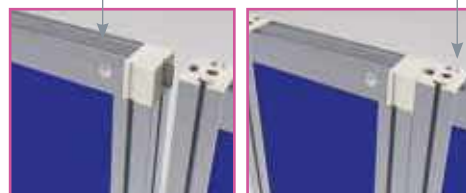

Each panel has a plain grooved side and a locking side, insert the locking side into the groove on the plain side and lock in place.

Provided key

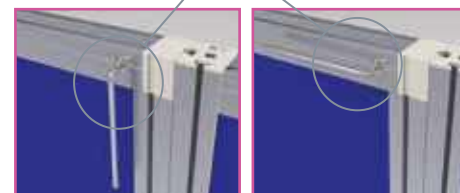

Lock in place with key provided for secure solid joint and repeat process for each panel.





# Classroom Furniture & Storage

A collection of products designed to enhance classroom and nursery environments.

Storage is an essential requirement in any classroom or nursery. Our Millhouse storage range is designed and manufactured in the UK with flexibility, durability and safety in mind.

In addition, we also have a vast selection of easels which inspire children to be creative and are effective in encouraging children to participate in group work. Children can write or draw their ideas on the board and then present their work to the rest of the class. Many of our easels are height adjustable to accommodate children of different ages.

## Classroom Furniture & Storage Contents

	Page
Tray and Shelf Storage	122-125
Drawer and Cupboard Storage	126-127
Junior Easels	128-135
Junior Partitions	136-137

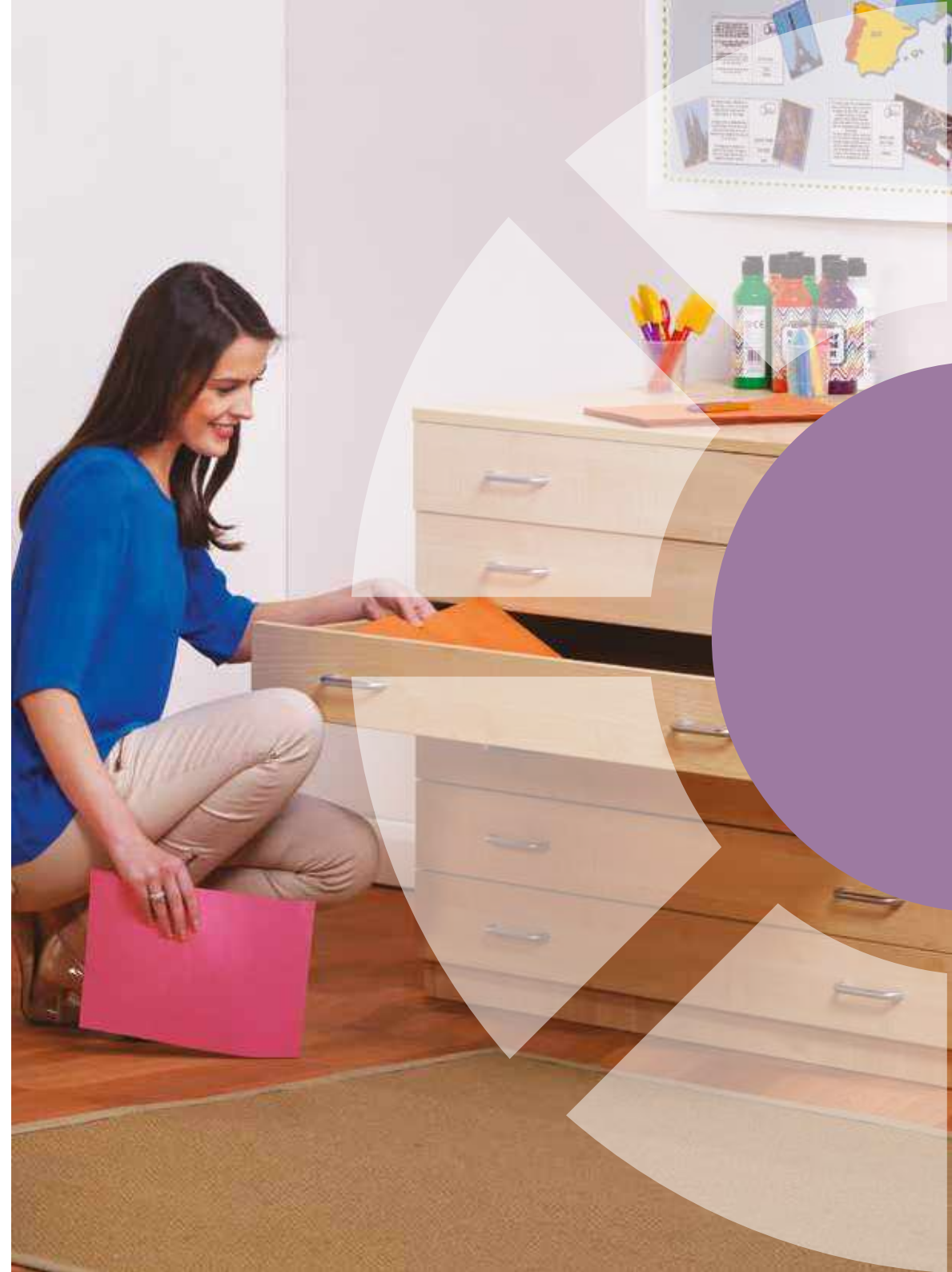

# Classroom Furniture & Storage



## Tray Storage Unit (1 column)

- Tray storage unit suitable for shallow and deep trays
- Premium MDF core with clear lacquered edges
- Heavy duty lockable castors with low noise, anti-scratch wheels
- Units are designed with flexible runners to house different depths of trays
- Compatible with Grattells F series trays
- Reverse features a loop nylon velcro fabric for display
- 9 tray colours to choose from
- Fully assembled
- 10 year product guarantee

### Tray Storage Unit (1 column)

Tray Storage Unit (1 column)	Code
360(w) X 730(h) X 465mm(d)	
3 deep trays	PT697
2 shallow, 2 deep trays	PT698
6 shallow trays	PT683



### Translucent Tray Colour



Blueberry Grape Kiwi Lemon Clear

### NEW

### Solid Tray Colour

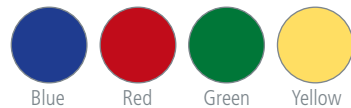

Blue Red Green Yellow



## Tray Storage Unit (2 column)

- Tray storage unit suitable for shallow and deep trays
- Premium MDF core with clear lacquered edges
- Heavy duty lockable castors with low noise, anti-scratch wheels
- Units are designed with flexible runners to house different depths of trays
- Compatible with Grattells F series trays
- Reverse features a loop nylon Velcro fabric for display
- 9 tray colours to choose from
- Fully assembled
- 10 year product guarantee

### Tray Storage Unit (2 column)

Tray Storage Unit (2 column)	Code
700(w) X 730mm(h) X 465mm(d)	
6 deep trays	PT692
4 shallow, 4 deep trays	PT693
12 shallow trays	PT684



## Tray Storage Unit (3 column)

- Tray storage unit suitable for shallow and deep trays
- Premium MDF core with clear lacquered edges
- Heavy duty lockable castors with low noise, anti-scratch wheels
- Units are designed with flexible runners to house different depths of trays
- Compatible with Grattells F series trays
- Reverse features a loop nylon Velcro fabric for display
- 9 tray colours to choose from
- Fully assembled
- 10 year product guarantee

### Tray Storage Unit (3 column)

Tray Storage Unit (3 column)	Code
1045(w) X 730mm(h) X 465mm(d)	
9 deep trays	PT647
6 shallow, 6 deep trays	PT650
18 shallow trays	PT644

### Tray Storage Unit (3 column)

Tray Storage Unit (3 column)	Code
1045(w) X 900mm(h) X 465mm(d)	
12 deep trays	PT648
6 shallow, 9 deep trays	PT651
24 shallow trays	PT645

### Tray Storage Unit (3 column)

Tray Storage Unit (3 column)	Code
1045(w) X 1080mm(h) X 465mm(d)	
15 deep trays	PT649
6 shallow, 12 deep trays	PT652
30 shallow trays	PT646





**Reconfigure**  
The flexible runners on these tray storage units maximise storage options and allow the units to be easily reconfigured. The loop nylon on the reverse of the units is ideal for displaying work and provides a tactile surface for children.

# Classroom Furniture & Storage



## 2 Column Shelf Storage

- Storage unit with space for 4 jumbo size trays
- Premium MDF core with clear lacquered edges
- Heavy duty lockable castors with low noise, anti-scratch wheels
- Reverse features a loop nylon Velcro fabric for display
- No built in runners, trays simply sit on shelf
- Available with and without trays
- 9 tray colours to choose from
- Fully assembled
- 10 year product guarantee

### 2 Column Shelf Storage

700(w) X 900(h) X 465mm(d)

	Code
Without trays	PT685
With trays	PT694

## 3 Column Shelf Storage

- Storage unit with space for 12 deep trays
- Premium MDF core with clear lacquered edges
- Heavy duty lockable castors with low noise, anti-scratch wheels
- Reverse features a loop nylon Velcro fabric for display
- No built in runners, trays simply sit on shelf
- Available with and without trays
- 9 tray colours to choose from
- Fully assembled
- 10 year product guarantee

### 3 Column Shelf Storage

1045(w) X 900(h) X 465mm(d)

	Code
Without trays	PT687
With trays	PT695

## 4 Column Shelf Storage

- Storage unit with space for 8 jumbo size trays
- Premium MDF core with clear lacquered edges
- Heavy duty lockable castors with low noise, anti-scratch wheels
- Reverse features a loop nylon Velcro fabric for display
- No built in runners, trays simply sit on shelf
- Available with and without trays
- 9 tray colours to choose from
- Fully assembled
- 10 year product guarantee

### 4 Column Shelf Storage

1386(w) X 900(h) X 465mm(d)

	Code
Without trays	PT686
With trays	PT696

### Translucent Tray Colour



### NEW

### Solid Tray Colour

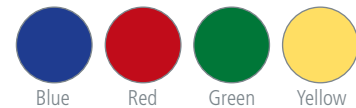

Clear Trays



Multi-coloured Trays



## Store

Flexible shelf storage solutions for nursery and classroom environments. There are no built-in runners, so the trays simply sit on the shelves. If you prefer the unit without trays, they are ideal for storing books and resources.



### Plan Chest

- 6 drawer plan chest made from durable, hardwearing, maple melamine
- High quality runners to ensure smooth operation
- Ideal storage solution for class resources
- Sturdy construction
- Perfect fit for A1 paper
- Fully assembled
- 5 year product guarantee

#### Plan Chest

1015(w) X 800(h) X 710mm(d)

#### Code

PT688



### Lockable Storage Cupboard

- 2 door, lockable storage cupboard
- Provides a secure storage solution for class resources or office files/books
- Made from maple melamine with solid beech features
- Features 3 shelves of which 2 are height adjustable
- Fully assembled
- 5 year product guarantee

#### NEW

#### Lockable Storage Cupboard

1000(w) X 1000(h) X 495mm(d)

#### Code

PT888



### Lockable Tall Storage Cupboard

- Lockable tall storage cupboard with 2 doors
- Provides a secure storage solution for class resources or office files/books
- Made from maple melamine with solid beech features
- Features 6 shelves of which 4 are height adjustable
- Fully assembled
- 5 year product guarantee

#### Lockable Tall Storage Cupboard

1000(w) X 1800(h) X 495mm(d)

#### Code

PT689



# Literacy Basics

**Nouns**  
are naming words.  
They can be a person, place or thing.

**Verbs**  
are doing words,  
such as actions or gestures.

**Proper Nouns**  
are the proper names  
for people, places and things.  
They always start with a capital letter.

**Adverbs**  
add description to the verb.  
They may add meaning; how? in what way?  
when? where? and to what extent.

**Adjectives**  
are describing words  
and give more information on the subject.

**Connectives**  
are joining words,  
and connect one sentence to another.



**Robust**  
With a robust and high quality construction, the plan chest and lockable storage cupboard are the ideal addition to any classroom. Both are delivered fully assembled to save time, effort and hassle.

# Classroom Furniture & Storage



## Little Acorns Share 'N' Write Desktop Easel

- Desktop easel with solid wood frame
- Suitable for use on the floor or on a desktop
- Double-sided design folds away for easy storage
- Display board size 600(w) x 450mm(h)
- Magnetic dry-wipe surface with a chalkboard on the reverse
- Features heavy duty steel carry handle and side stay
- Handy ledge on both sides for displaying a book or holding pens
- 10 year product guarantee



## Little Acorns Store 'N' Write Mobile Easel

- Mobile easel with solid wood frame
- Single sided magnetic whiteboard
- Display board size 600(w) x 900mm(h)
- Features heavy duty locking wheels
- Available with or without storage tray
- Full length pen ledge
- Foot print: 630(w) x 530mm(d)
- 10 year product guarantee



Storage Box



## Little Acorns Play 'N' Learn Mobile Easel

- Double-sided mobile easel with solid wood frame
- Magnetic dry-wipe surface with a chalkboard on the reverse
- Display board size 600(w) x 900mm(h)
- Sturdy and stable construction
- Includes large storage tray and paper roll holder
- Features heavy duty locking wheels for ease of movement
- Foot print: 630(w) x 600mm(d)
- 10 year product guarantee



Share 'N' Write	Code
White/Chalk 600(w) X 450mm(h)	3307

Store 'N' Write Easel	Code
630(w) X 1400(h) X 530mm(d)	3303

Store 'N' Write Easel with Storage	Code
630(w) X 1400(h) X 530mm(d)	3302

Play 'N' Learn	Code
630(w) X 1520(h) X 600mm(d)	3301



Paper Roll



Paint Pots

	Code
Paper Roll	3320
Paint Pots	3321







fin  
teeth  
tail



### Learn

Little Acorns products are beautifully made from solid wood. These premium products are designed with helpful features such as book ledges and storage trays which are ideal for supporting classroom learning.

# Classroom Furniture & Storage



## Little Rainbows Mobile Magnetic Display Easel

- Mobile adjustable easel with coloured steel frame
- Choose from single-sided or double-sided
- Display board size 600(w) x 900mm(h)
- Ergonomically designed with a 12.5 degree writing angle
- Magnetic dry wipe surface
- Features 4 locking castors for safety
- Integral flip chart clamp and big book display ledge
- Foot Print: 652(w) x 642mm(d) (single) and 652(w) x 664mm(d) (double)
- 2 colours to choose from
- 5 year surface guarantee

## Little Rainbows Store 'N' Write Big Book Board

- Big book board with sturdy steel frame and storage
- Magnetic or non-magnetic dry wipe writing surface
- Ergonomically designed with a 15 degree writing angle
- Display board size 600(w) x 900mm(h)
- Easy to transport with 2 locking castors
- Full length big book display ledge
- Foot Print: 600(w) x 450mm(d)
- 2 colours to choose from
- 5 year surface guarantee

## Little Rainbows Mobile Magnetic Display/Storage Easel

- Mobile adjustable easel with coloured steel frame
- Choose from single-sided or double-sided
- Display board size 900(w) x 900mm(h)
- Ergonomically designed with a 12.5 degree writing angle
- Magnetic dry wipe surface
- Features 4 locking castors for safety
- Integral flip chart clamp and big book display ledge
- Foot Print: 952(w) x 642mm(d) (single) and 952(w) x 664mm(d) (double)
- Supplied with 2 storage trays (red trays with blue frame, blue trays with red frame)
- 5 year surface guarantee

Mobile Magnetic Display Easel	Code
Single Sided 652(w) X 1350(h) X 642mm(d)	1679
Double-sided 652(w) X 1350(h) X 664mm(d)	1685

Non-magnetic Big Book Board	Code
600(w) X 1340(h) X 450mm(d)	1699

Magnetic Big Book Board	Code
600(w) X 1340(h) X 450mm(d)	1677

Mobile Magnetic Display/Storage Easel	Code
Single Sided 952(w) X 1450(h) X 642mm(d)	1678
Double-sided 952(w) X 1450(h) X 664mm(d)	1684

## Colour Options

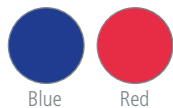

Blue

Red



Big Book Ledge



Big Book Storage



Flip Chart Clamp



Storage Trays

### Participate

Mobile magnetic easels are a great classroom resource, not only do they encourage children to be expressive but they can also be used for group activities. This Store 'N' Write big book board features a book ledge and storage tray.



# Classroom Furniture & Storage



## Little Rainbows Junior Mobile Writing Board

- Freestanding mobile writing board
- Double-sided with the choice of magnetic or non-magnetic surface
- Features 4 castors (2 locking) and stability bar
- Harlequin board frame with contrasting rounded safety corners
- Board can be height adjustable by 210mm
- Overall stand foot depth 540mm
- Blue steel frame
- 5 year surface guarantee



Non-magnetic	Code
600(w) X 900mm(h) Portrait	1670P
900(w) X 600mm(h) Landscape	1670L
900(w) X 1200mm(h) Portrait	1680P
1200(w) X 900mm(h) Landscape	1680L
1200(w) X 1500mm(h) Portrait	1690P
1500(w) X 1200mm(h) Landscape	1690L
Magnetic	Code
600(w) X 900mm(h) Portrait	1673P
900(w) X 600mm(h) Landscape	1673L
900(w) X 1200mm(h) Portrait	1683P
1200(w) X 900mm(h) Landscape	1683L
1200(w) X 1500mm(h) Portrait	1693P
1500(w) X 1200mm(h) Landscape	1693L

Board Size (w x h)	Total Size (w x h)
600 x 900 mm Portrait	640 x 1580 mm
900 x 600 mm Landscape	940 x 1420 mm
900 x 1200 mm Portrait	940 x 1730 mm
1200 x 900 mm Landscape	1240 x 1580 mm
1200 x 1500 mm Portrait	1240 x 1880 mm
1500 x 1200 mm Landscape	1540 x 1730 mm



## Little Rainbows Mobile Tilt 'N' Teach

- Rotating double-sided whiteboard
- Choice of magnetic or non-magnetic surface
- Display board size 900(w) x 600mm(h)
- Lockable in any position
- Features 4 lockable castors and stability bar
- Full length ledge for displaying big books
- 2 colours to choose from
- Aluminium frame
- Foot print: 1000(w) x 500mm(d)
- 5 year surface guarantee



Non-magnetic Mobile Tilt 'N' Teach	Code
1000(w) X 1300(h) X 500mm(d) Grey	1675
1000(w) X 1300(h) X 500mm(d) Red	1675/3

Magnetic Mobile Tilt 'N' Teach	Code
1000(w) X 1300(h) X 500mm(d) Grey	1676
1000(w) X 1300(h) X 500mm(d) Red	1676/3



### Rotating

Junior mobile writing boards are a handy class resource and the Mobile Tilt 'n' Teach has the flexibility of a rotating, double sided whiteboard which can lock in any position.

# Classroom Furniture & Storage



## Little Rainbows Read 'N' Write Board

- Aluminium framed board with easy carry handle
- Suitable for use on the floor or on a desktop
- Choice of magnetic or non-magnetic surface
- Display board size 900(w) x 600mm(h)
- Features heavy duty carry handle and side stay
- Full length big book ledge
- Folds flat for storage
- 5 year surface guarantee

Non-magnetic Read 'N' Write Board	Code
900(w) X 600mm(h)	3536

Magnetic Read 'N' Write Board	Code
900(w) X 600mm(h)	3537



## Little Rainbows Desktop Easel

- Aluminium framed desktop easel with rounded safety corners
- Suitable for use on the floor or on a desktop
- Choice of magnetic (aluminium frame) or non-magnetic (harlequin frame) surface
- Display board size 600(w) x 500mm(h)
- Anti-slip safety catch on side
- Integrated flip chart clamp
- Folds flat for storage
- 5 year surface guarantee

Non-magnetic Desktop Easel	Code
600(w) X 500mm(h) (Harlequin frame)	3502

Magnetic Desktop Easel	Code
600(w) X 500mm(h) (Aluminium frame)	3509



## Little Rainbows Twin Desktop Easel

- Double-sided, aluminium framed desktop easel
- Choice of magnetic or non-magnetic surface
- Suitable for use on the floor or on a desktop
- Display board size 600(w) x 450mm(h)
- Harlequin in colour with rounded safety corners
- Anti-slip safety catch on side
- Plastic bumpers prevent accidental slipping
- Folds flat for storage
- 5 year surface guarantee

Non-magnetic Desktop Easel	Code
600(w) X 450mm(h)	3515

Magnetic Desktop Easel	Code
600(w) X 450mm(h)	3518



Flip Chart Clamp

## Writing Board Accessories



Dry Wipe Pens

Size	Code
Pk 4	DMPENSTASS4



Mini Dusters

Size	Code
Pk 30	MINIDUSTER30



Junior Dry Wipe Pens

Size	Code
Pack of 10 Black	CLASSPACK PEN



Board Cleaner

Size	Code
250ml Spray	DWS.25
1.0lt Bottle	DWC1
2.5lt Bottle	DWC2.5



**Practical**  
Although designed with desktop use in mind, these easels can also be used on the floor depending on the activity or task. Various features have been incorporated in the design of the products to ensure they are practical and safe to use.



# Classroom Furniture & Storage



## Little Rainbows Freestanding Junior Partition

- Double-sided harlequin style aluminium framed partition
- Steel stabiliser feet
- Panels may be used landscape or portrait
- Partitions can be nested when not in use
- Felt finish suitable for pins
- 4 colour options to choose from
- 2 year product guarantee

Junior Partitions	Code
1200(w) X 900mm(h)	2901
1500(w) X 1200mm(h)	2904

### Colour Options (Little Rainbows Partitions)

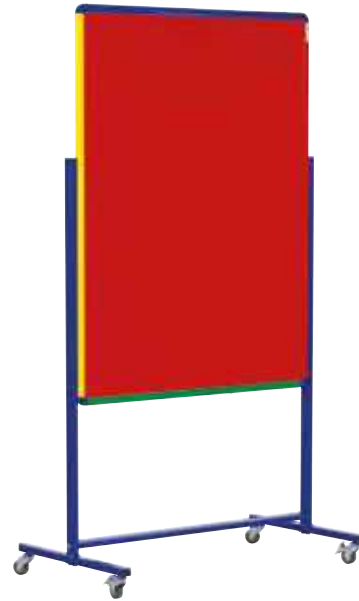
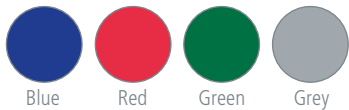

## Little Rainbows Junior Mobile Partition

- Double-sided, harlequin style aluminium framed partition
- Mobile blue steel frame with 4 locking castors
- Choice of landscape or portrait panels
- Height adjustable by 210mm
- Felt finish suitable for pins
- 4 colour options to choose from
- 2 year product guarantee

Board Size (w x h)	Total Size (w x h)
900 x 1200 mm Portrait	940 x 1730 mm
1200 x 900 mm Landscape	1240 x 1580 mm
1200 x 1500 mm Portrait	1240 x 1880 mm
1500 x 1200 mm Landscape	1540 x 1730 mm

Junior Mobile Partitions	Code
900(w) X 1200mm(h) Portrait	2902P
1200(w) X 900mm(h) Landscape	2902L
1200(w) X 1500mm(h) Portrait	2905P
1500(w) X 1200mm(h) Landscape	2905L



## Little Acorns Wooden Frame Junior Partition

- Double-sided solid wood display partition
- Steamed beech wood frame and foot plate from sustainable sources
- Supplied with glides and castors for static or mobile use
- Felt finish suitable for pins
- 5 colour options to choose from
- 10 year product guarantee

Wood Frame Junior Partitions	Code
1200(w) X 900mm(h)	4449
900(w) X 1200mm(h)	4450
1200(w) X 1200mm(h)	4451
1500(w) X 1200mm(h)	4452

### Colour Options (Little Acorns Partition)







**Space**  
Junior partitions are ideal for displaying work or dividing space within a classroom or nursery. Whether you create a cosy reading corner or play area, the robust design is well suited to education environments.

A large, stylized logo graphic consisting of several overlapping circular and semi-circular shapes in shades of grey, white, and orange. The word "SPACERIGHT" is written in a bold, sans-serif font across the center of the graphic, with "europe ltd" in a smaller font below it.

**SPACERIGHT**  
europe ltd

[www.spacerighteurope.com](http://www.spacerighteurope.com)

Spaceright Europe Ltd  
38 Tollpark Road, Wardpark East,  
Cumbernauld, G68 0LW  
T: 01236 853120 F: 01236 853123  
E: [sales@spacerighteurope.com](mailto:sales@spacerighteurope.com)

