

HOOVER

INSTRUCTION MANUAL

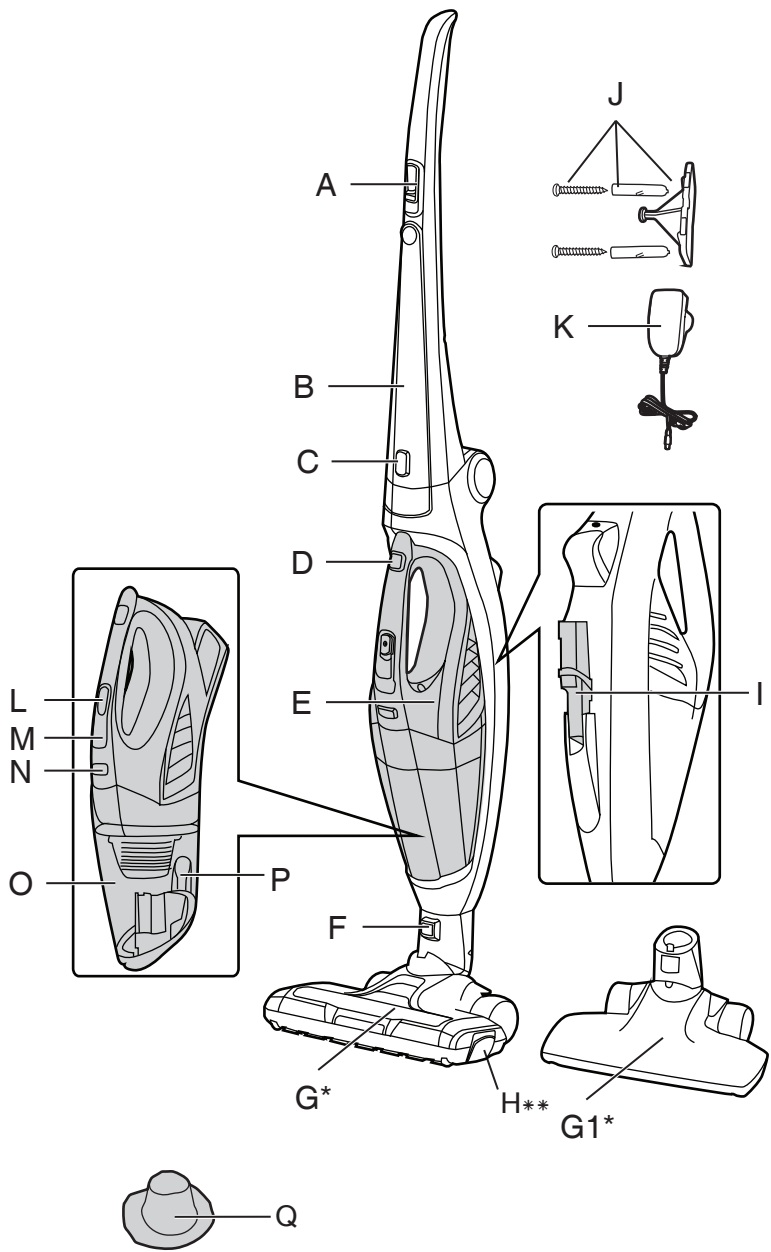

BORN INNOVATIVE



*Nozzle design may vary according to models **Motorized Nozzle only

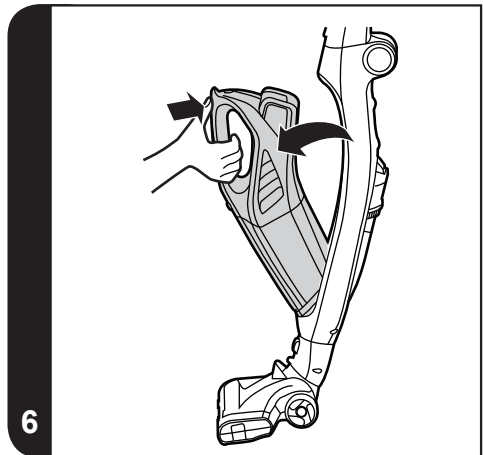
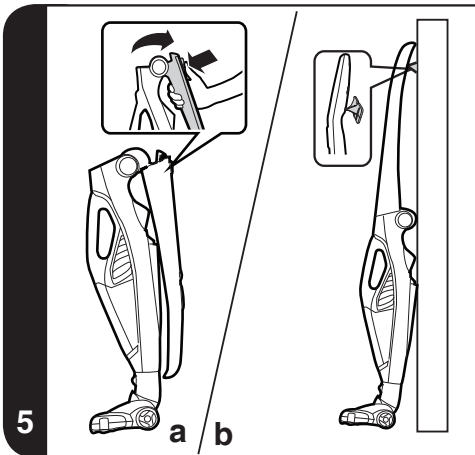
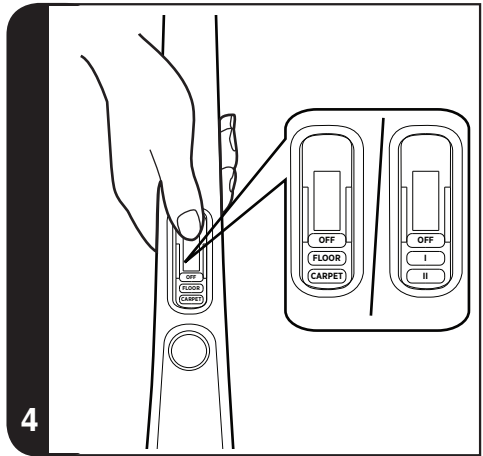
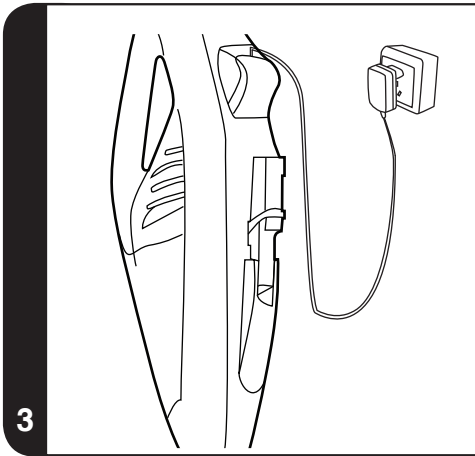
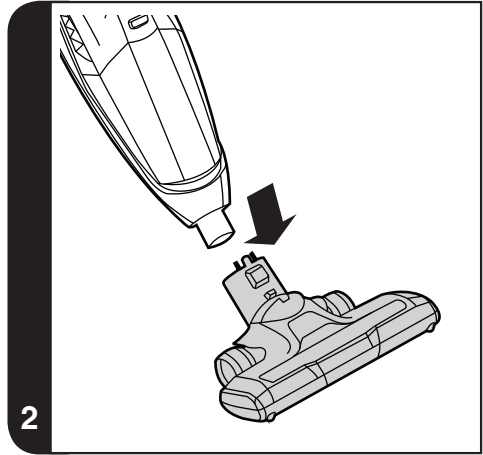
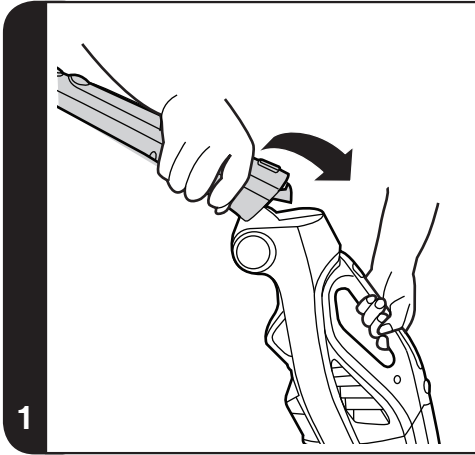

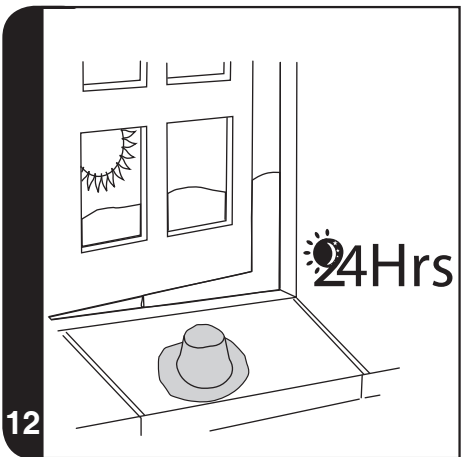
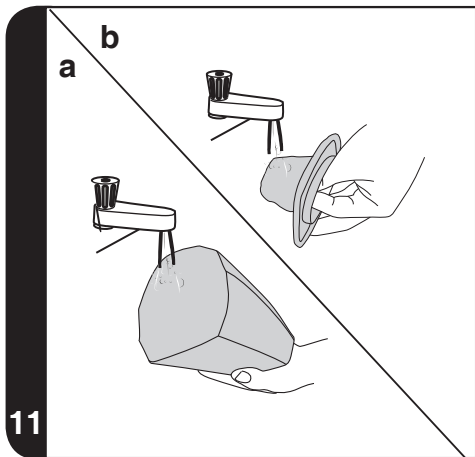
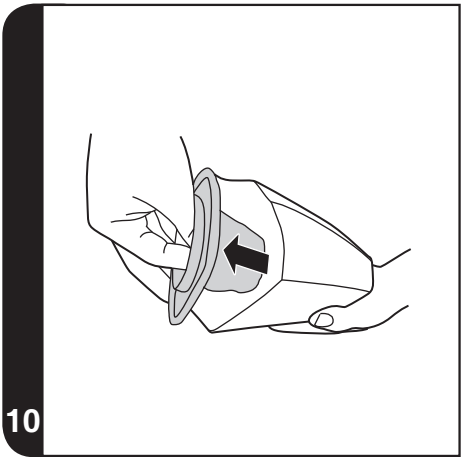
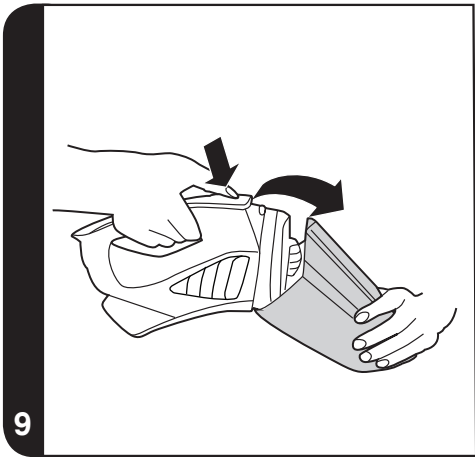
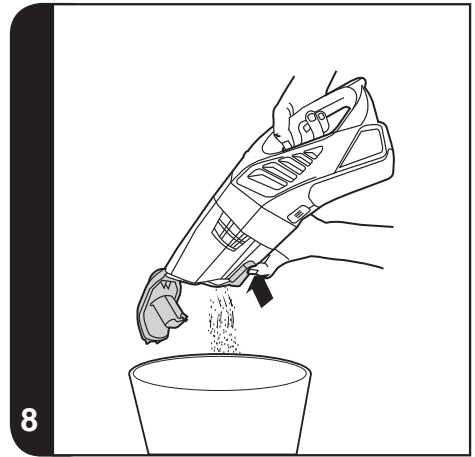
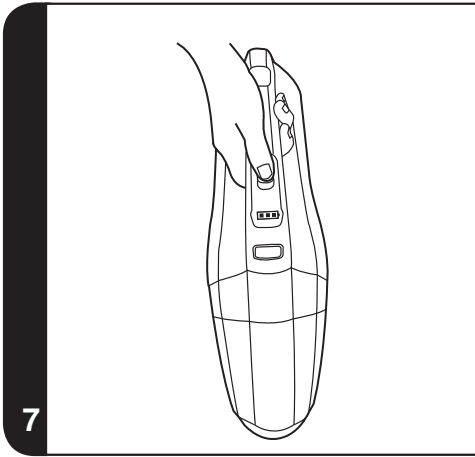

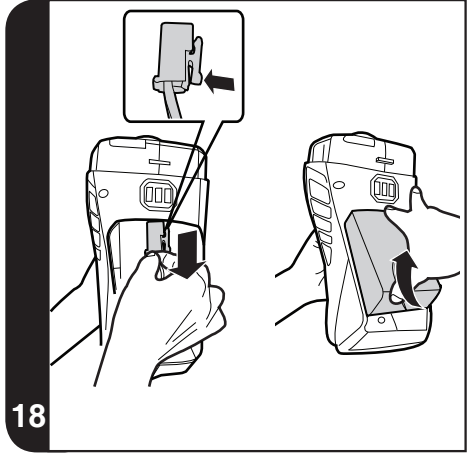
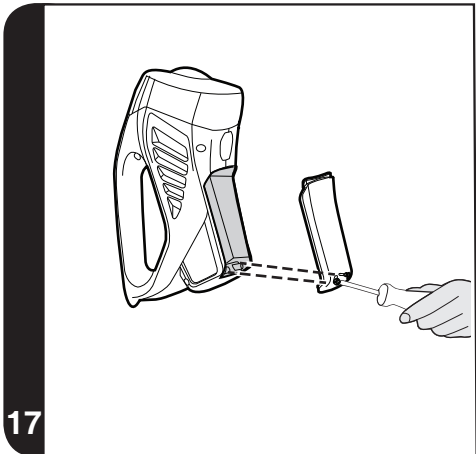
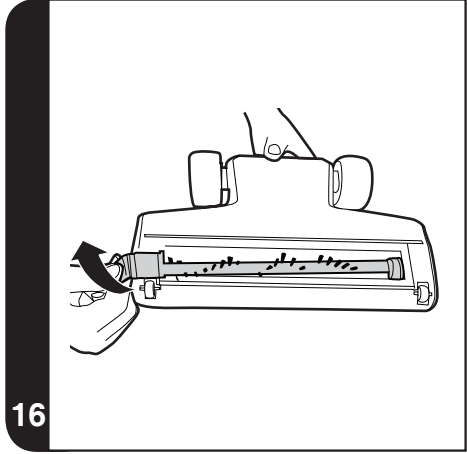
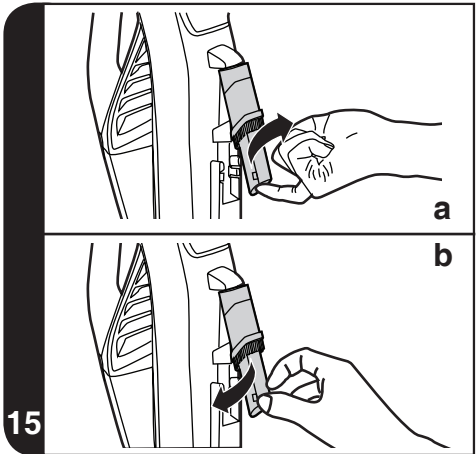
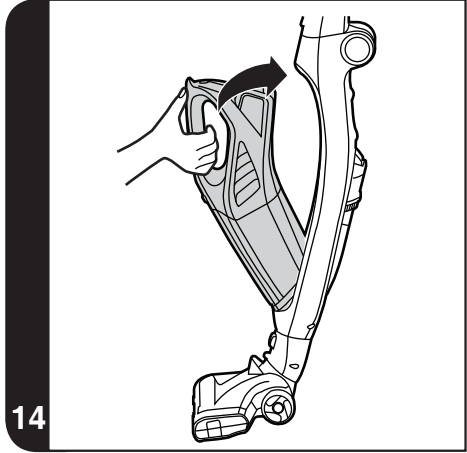
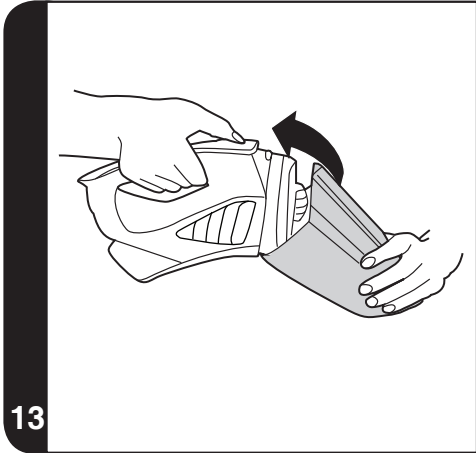

INSTRUCTIONS FOR SAFE USE

This appliance should only be used for domestic cleaning, as described in this user guide. Please ensure that this guide is fully understood before operating the appliance.

Always switch off and remove the charger from the socket before cleaning the appliance or any maintenance task.

This appliance can be used by children aged from 8 years and above and persons with reduced physical, sensory or mental capabilities or lack of experience and knowledge if they have been given supervision or instruction concerning use of the appliance in a safe way and understand the hazards involved. Children shall not play with the appliance. Cleaning and user maintenance shall not be made by children without supervision.

If the power cord is damaged stop using the appliance immediately. To avoid a safety hazard, an authorised Hoover service engineer must replace the power cord.

Keep hands, feet, loose clothing and hair away from rotating brushes.

Use only the original charger supplied with the appliance.

Check that your supply voltage is the same as that stated on the charger.

This appliance is supplied with a double insulated battery charger which is only suitable for insertion in a 230V (UK 240V) socket outlet.

Plug the charger in to a suitable socket outlet and connect the power cord connector to the DC socket on the appliance. **[3]**

For first use, charge your cleaner for 24Hrs. After first use the normal charging time is 12Hrs.

When the product is charging the middle indicator light will be red and will turn blue when fully charged.

During storage and charging, secure your appliance handle into the product holder.

Never charge the batteries in temperatures above 37°C or below 0°C.

When charging the appliance, the power switch must be off.

Do plug in the charger after use to recharge the batteries.

It is normal for the charger to become warm to the touch when charging. Do not unplug the charger by pulling on the power cord.

Unplug the charger in the event of prolonged absence (holidays, etc.). Recharge appliance again before use as batteries may self discharge over increased periods of storage.

If the appliance is to be disposed of the batteries must first be removed. The appliance must be disconnected from the supply mains when removing the battery. Dispose of the batteries safely. Used batteries should be taken to a recycling station and not disposed of with household waste. To remove the batteries, please contact the Hoover Customer Centre or proceed according to the following instructions.

Always fully discharge the batteries before removal and ensure charger is unplugged.

1. Run the unit until the batteries are completely empty. When the batteries are fully discharged, the indicator will flash about 20 times before cleaner switches off automatically.
2. Release the handheld unit from the main body of the cleaner. [6]
3. Press the dust container release button and remove the dust container. [9]
4. Remove 2 screws and open the unit.[17]
5. Disconnect the cables and remove the batteries from the housing. [18]

NOTE: Should you experience any difficulty in dismantling the unit or for more detailed information on treatment, recovery and recycling of this appliance, please contact your local city office or your household waste disposal service.

DO NOT expose the batteries to a room temperature above 40°C. Use only attachments, consumables or spares recommended or supplied by Hoover.

Static electricity: some carpets can cause a small build up of static electricity. Any static discharge is not hazardous to health.

Do not use your appliance out of doors or on any wet surface or for wet pick up.

Do not pick up hard or sharp objects, matches, hot ashes, cigarette ends or other similar items.

Do not spray with or pick up flammable liquids, cleaning fluids, aerosols or their vapours.

Do not run over the power cord when using your appliance or remove the plug by pulling on the power cord.

Do not continue to use your appliance or charger if it appears faulty.

Hoover service: To ensure the continued safe and efficient operation

of this appliance we recommend that any servicing or repairs are only carried out by an authorised Hoover service engineer.

Do not replace the batteries with non-rechargeable batteries.
Do frequently clean the dust cup and filter assembly.

The Environment

The symbol on this appliance indicates that this appliance may not be treated as household waste. Instead it must be handed over to the applicable collection point for the recycling of electrical and electronic equipment. Disposal must be carried out in accordance with local environmental regulations for waste disposal. For more detailed information about treatment, recovery and recycling of this appliance, please contact your local city office, your household and waste disposal service or the shop where you purchased the appliance.



This appliance complies with the European Directives 2014/35/EU, 2014/30/EU and 2011/65/EU.

CANDY HOOVER GROUP S.r.l. Via Privata Eden Fumagalli, 20861 Brugherio (MB) Italy

PRODUCT COMPONENTS

Main Cleaner

- A. On/Off Switch And Mode Selector
- B. Main Body
- C. Foldaway Handle Release Button
- D. Handheld Release Button
- E. Handheld Unit
- F. Nozzle Release Button
- G. Motorized Nozzle*
- G1. Floor Nozzle *
- H. Agitator Release Button**
- I. Crevice Tool / Dusting Brush
- J. Product Holder
- K. Charger

Handheld Cleaner

- L. On/Off Switch
- M. LED Indicator
- N. Dust Container Release Button
- O. Dust Container
- P. Dust Bin Flap release Button

Filter

- Q. Cloth Filter

PREPARING YOUR CLEANER

1. Unfold the handle to the main body until it locks in place. **[1]**
2. Attach the nozzle to the main body, push firmly until it locks in place. **[2]**
3. For first use, charge your cleaner for 24Hrs. After first use the normal charging time is 12Hrs.
4. When the product is charging the middle indicator light will be red and will turn blue when fully charged.
5. The product holder can be fixed to the wall using the screws provided. **[5b]**

NOTE: To remove the nozzle, press the nozzle release button and pull away from the main body.

NOTE: Use only the charger supplied with your cleaner to recharge.

IMPORTANT: When charging the cleaner, the On/Off switch must be OFF.

It is normal for the charger to become warm to touch when charging.

If the operating time reduces after repeated use let the cleaner run until it stops then recharge it for 24Hrs, repeat this monthly for optimum performance.

Unplug the charger in the event of prolonged absence (holidays, etc.). Recharge product again before use as battery may self discharge over increased periods of storage.

*Nozzle design may vary according to models

**Motorized Nozzle only

USING YOUR CLEANER

Main Cleaner With Motorized Nozzle [G]*

Turn the cleaner on by sliding the On/Off switch to the following settings [4]:

- **HARD FLOOR:** First position of On/Off switch ideal for hard floor surfaces, the cleaner is in the lower settings, and the agitator** and nozzle LED lights** are OFF.
- **CARPET:** Second position of On/Off switch ideal for carpets and rugs, the cleaner is in the higher settings, and the agitator** and nozzle LED lights **are ON.

Main Cleaner With Floor Nozzle [G1]*

Turn the cleaner on by sliding the ON/OFF switch forwards to one of the following settings [4]:

Power Level I: First position of On/Off switch. Ideal for simple cleaning tasks, the cleaner is in the lower setting.

Power Level II: Second position of On/Off switch. For tougher cleaning tasks, the cleaner is in the higher setting.

Handheld Cleaner

1. Press the handheld release button, lift the handheld unit from the main body. [6]
2. Turn the handheld cleaner on by sliding the On/Off switch forward. [7]

DISCHARGE INDICATOR: When the batteries are fully discharged, the indicator will flash about 20 times before cleaner switches off automatically.

Crevice Tool / Dusting Brush

The accessory is stored at the rear of the main body, they can be fitted directly onto the handheld unit.

Take it out from the rear of the main body before use, [15a] and put it back after use. [15b]

IMPORTANT: For storage, the product handle can be fixed into the holder [5b] or it can be folded for easy storage. [5a]

CLEANER MAINTENANCE

Emptying the Dust Container

Hold the handheld cleaning unit over a bin and press the dust bin release flap button to empty the dust container. [8]

Cleaning the Filter

1. Press the handheld unit release button, lift the handheld unit from cleaner main body. [6]
2. Press the dust container release button and remove the dust container. [9]
3. Lift the filter from the dust container. [10]
4. Wash the filter in lukewarm water and leave to dry for 24 Hrs. [11b,12] Once thoroughly dry return to the dust container.
5. If required, wash the dust container in lukewarm water. [11a] Ensure it is fully dry before returning to the main body of the cleaner.
6. Reassemble the handheld unit and return to the cleaner main body. [13,14]

NOTE: Do not use hot water or detergents when cleaning the filters. In the unlikely event of the filters becoming damaged, fit a genuine Hoover replacement. Do not try to use the product without a filter fitted.

IMPORTANT: For optimum performance, always keep your filter clean. We recommend that the filter should be washed at least once a month.

Changing and Cleaning the Agitator**

IMPORTANT: Always switch off the cleaner before changing the agitator.

1. Open the Agitator Release Button outward. [16]
2. Remove the Agitator. [16]
3. Replace with the new Agitator or clean it.
5. Re- fit the Agitator and press the Agitator Release Button until it locks in place.

Battery Replacement

When the batteries fail to maintain charge, please contact the Hoover Customer Service Centre to obtain a replacement battery.

WARNING: Only use approved replacement parts for your vacuum cleaner. Using parts not validated by

*Nozzle design may vary according to models **Motorized Nozzle only

Hoover are dangerous and will invalidate your guarantee.

WARNING: Always make sure your device is switched off before changing your batteries.

IMPORTANT: Always fully discharge the batteries before removal and ensure charger is unplugged.

1. Run the unit until the batteries are completely empty. When the battery is fully discharged, the indicator will flash about 20 times before the cleaner switches off automatically.
2. Release the handheld unit from the main body of the cleaner. **[6]**
3. Press the dust container release button and remove the dust container. **[9]**
4. Remove 2 screws and open the unit. **[17]**
5. Disconnect the cables and remove the batteries from the housing. **[18]**
6. Fit the new battery and re-assemble the vacuum cleaner by reversing steps 2 – 5 above.

End of Product Life Battery Disposal

If the vacuum cleaner or used battery is to be disposed of the batteries should be removed. Used batteries should be taken to a recycling station and not disposed with household waste. To remove the batteries, please contact the Hoover Customer Service Centre or proceed according to the following instructions:

IMPORTANT: Always fully discharge the batteries before removal and ensure charger is unplugged.

1. Run the unit until the batteries are completely empty.
2. Release the handheld unit from the main body of the cleaner. **[6]**
3. Press the dust container release button and remove the dust container. **[9]**
4. Remove 2 screws and open the unit. **[17]**
5. Disconnect the cables and remove the batteries from the housing. **[18]**

NOTE: Should you experience any difficulties in dismantling the unit or for more detailed information about treatment, recovery and recycling of this product, please contact your local city office, your household waste disposal service.

TROUBLE SHOOTING

Should you have any problem with you cleaner, follow this simple check list before calling the Hoover Customer Service Centre:

A. Cleaner does not switch on.

Check if the cleaner is charged.

B. Loss of suction or no suction

Empty the dust container and wash the filter.

Remove nozzle and check for any blockages in the duct.

C. Batteries cannot be charged.

This may be a result of very long storage periods (over half year).

Contact Hoover customer service to arrange battery replacement.

If the problem persists contact the Hoover customer service centre.

IMPORTANT INFORMATION

Always replace parts with genuine Hoover spares. These are available from your local Hoover dealer or direct from Hoover. When ordering parts always quote your model number.

Your guarantee

The guarantee conditions for this appliance are as defined by our representative in the country in which it is sold. Details regarding these conditions can be obtained from the dealer from whom the appliance was purchased. The bill of sale or receipt must be produced when making any claim under the terms of this guarantee.

IMPORTANT: The battery of this cleaner is guaranteed for 6 months from the date of purchase. After 6 months the customer is liable for the cost of a new battery.

Subject to change without notice.

*Nozzle design may vary according to models **Motorized Nozzle only



®

BORN INNOVATIVE

PRINTED IN P.R.C
48023151