



# Owner's Manual IPS LED MONITOR (LED MONITOR\*)

\*LG LED Monitors are LCD Monitors with LED Backlighting.

Please read the safety information carefully before using the product.

IPS LED Monitor (LED Monitor) Model List

27UK850

27BK85U

# CONTENTS

## 3 LICENSE

---

## 4 ASSEMBLING AND PREPARING

---

- 4 Product Components
- 5 Supported Drivers and Software
- 6 Component and Button Description
  - 6 - How to Use the Joystick Button
- 7 Input Connector
- 8 Moving and Lifting the Monitor
- 9 Installing the Monitor
  - 9 - Assembling the stand base
  - 10 - Using the cable holder
  - 11 - Installing onto a table
  - 12 - Adjusting the angle
  - 12 - Adjusting the Stand Height
  - 13 - Pivot Feature
  - 14 - Using the Kensington lock
  - 15 - Detaching the Stand Body
  - 15 - Installing the wall mount plate
  - 15 - Installing to a wall

## 17 USING THE MONITOR

---

- 17 Connecting to a PC
  - 17 - HDMI connection
  - 17 - DisplayPort connection
  - 18 - USB-C connection
- 18 Connecting to AV Devices
  - 18 - HDMI connection
- 19 Connecting Peripherals
  - 19 - USB Cable connection - PC
- 19 Connecting to External Devices
  - 19 - Connecting Headphones

## 20 USER SETTINGS

---

- 20 Activating the Main Menu
  - 20 - Main Menu Features
- 21 User Settings
  - 21 - Menu Settings

## 26 TROUBLESHOOTING

---

## 28 SPECIFICATIONS

---

- 28 27UK850/27BK85U
- 29 Factory Support Mode (Preset Mode, PC)
- 29 HDMI
- 29 DisplayPort / USB-C
- 30 HDMI Timing (Video)
- 30 Power LED

## LICENSE

Each model has different licenses. Visit [www.lg.com](http://www.lg.com) for more information on the license.



The terms HDMI and HDMI High-Definition Multimedia Interface, and the HDMI Logo are trademarks or registered trademarks of HDMI Licensing Administrator, Inc. in the United States and other countries.



VESA, VESA logo, DisplayPort compliance logo and DisplayPort compliance logo for dual-mode source devices are all registered trademarks of the Video Electronics Standards Association.



MaxxAudio and additional MAXX trademarks are trademarks and/or registered trademarks of Waves Audio Ltd.



The SuperSpeed USB Trident logo is a registered trademark of USB Implementers Forum, Inc.

USB Type-C™ and USB-C™ are trademarks of USB Implementers Forum.

The following content is only applied to the monitor which is sold in Europe market and which needs to meet the ErP Directive:

\* This monitor is set to be turned off automatically in 4 hours after you turned on display if there is no adjustment to display.

\* To make this setting be disabled, change the option to 'Off' in OSD menu of "Automatic Standby".

# ASSEMBLING AND PREPARING

## Product Components

Please check whether all the components are included in the box before using the product. If there are missing components, contact the retail store where you purchased the product. Note that the product and components may look different from those shown here.



**CD(Owner's Manual) /  
Card**



**Power Cord**

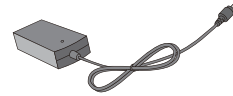

**AC-DC Adapter**

( Depending on the country )

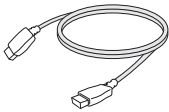

**HDMI Cable**  
( Depending on the coun-  
try )

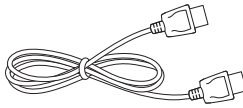

**DisplayPort Cable**

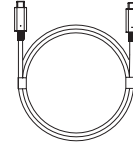

**USB C-C cable**

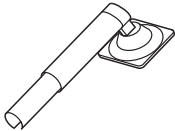

**Stand Body**



**Stand Base**



**Cable Holder**



### CAUTION

- Always use genuine components to ensure safety and product performance.
- The product warranty will not cover damage or injury caused by the use of counterfeit components.
- It is recommend that use the supplied components.
- If you use generic cables not certified by LG, the screen may not display or there may be image noises.



### NOTE

- Note that the components may look different from those shown here.
- Without prior notice, all information and specifications in this manual are subject to change to improve the performance of the product.
- To purchase optional accessories, visit an electronics store or online shopping site or contact the retail store where you purchased the product.

## Supported Drivers and Software

Check the drivers and software supported by your product and refer to the manuals on the CD enclosed in the product package.

Drivers and Software	Installation Priority	27UK850/27BK85U
Monitor Driver	Recommended	0
OnScreen Control	Recommended	0
Dual Controller	Optional	0
True Color Pro	Optional	0

- Required and Recommended: You can download and install the latest version from the enclosed CD or from the LGE website ([www.lg.com](http://www.lg.com)).
- Optional: You can download and install the latest version from the LGE website ([www.lg.com](http://www.lg.com)).

## Component and Button Description

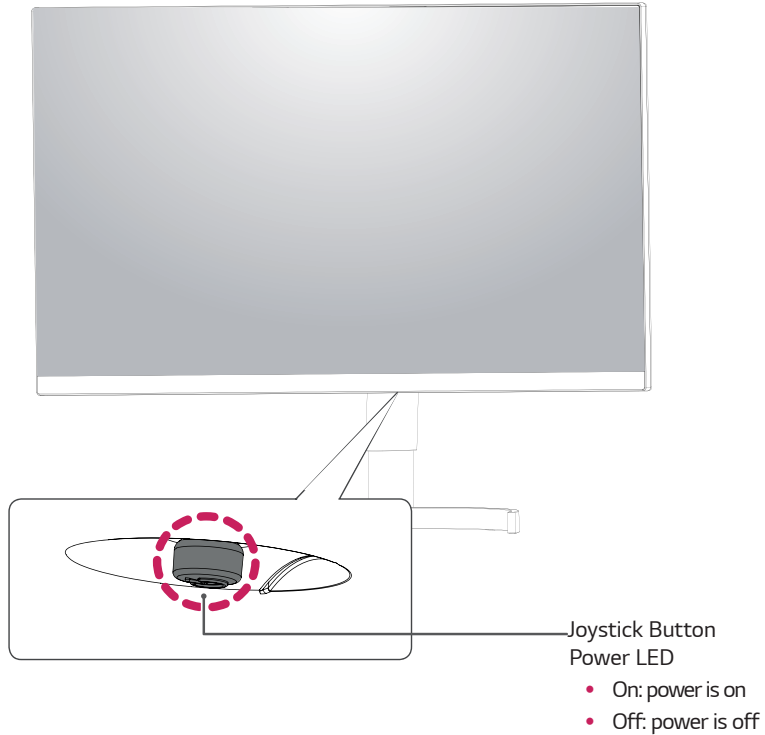

### How to Use the Joystick Button

You can easily control the functions of the monitor by pressing the joystick button or moving it left/right with your finger.

#### Basic Functions

		<b>Power on</b>	Press the joystick button once with your finger to turn on the monitor.
		<b>Power off</b>	Press and hold the joystick button once with your finger to turn off the monitor.
		<b>Volume Control</b>	You can control the volume by moving the joystick button left/right.



#### NOTE

- The joystick button is located at the bottom of the monitor.

## Input Connector

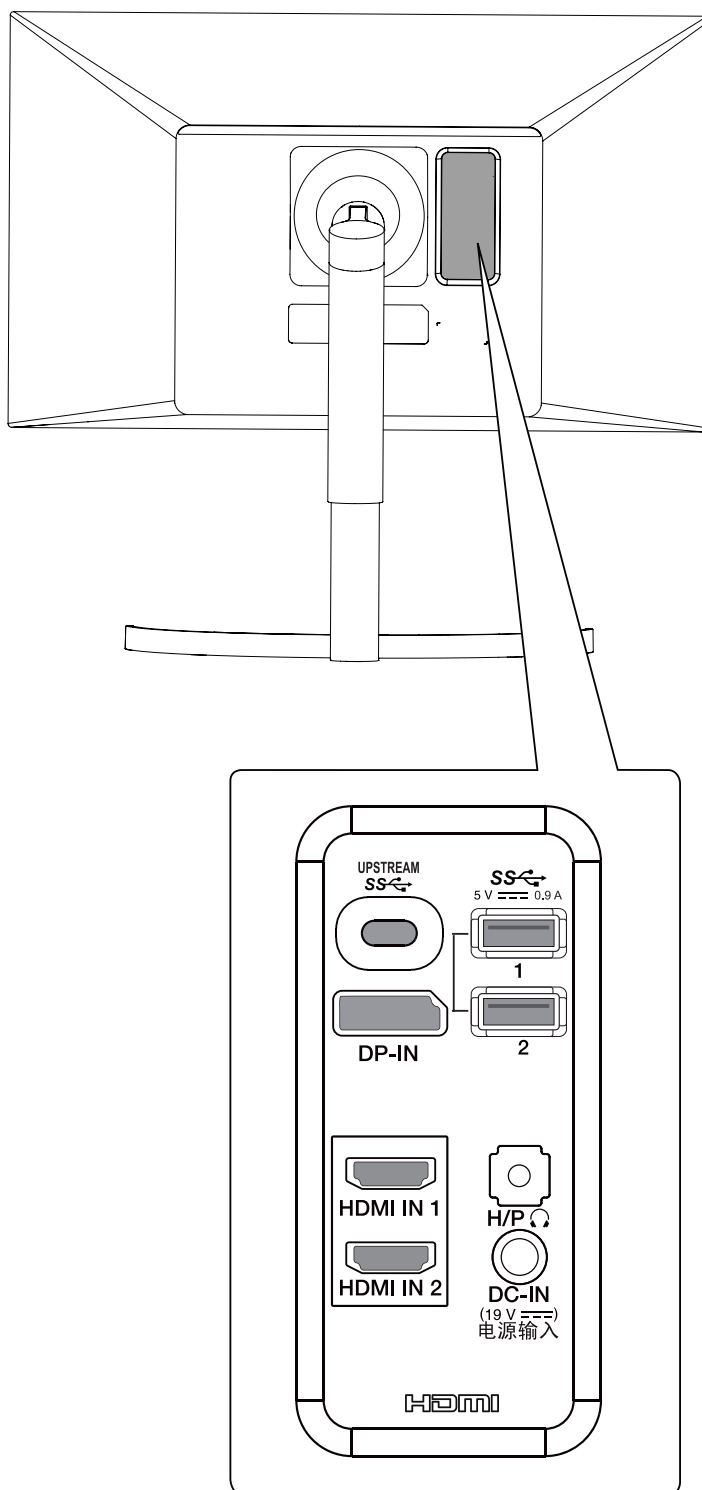

## Moving and Lifting the Monitor

When moving or lifting the monitor, follow these instructions to prevent the monitor from being scratched or damaged and to ensure safe transportation regardless of its shape or size.

- It is advisable to place the monitor in the original box or packing material before attempting to move it.
- Before moving or lifting the monitor, disconnect the power cord and all cables.
- Hold the top and bottom of the monitor frame firmly. Do not hold the screen itself.

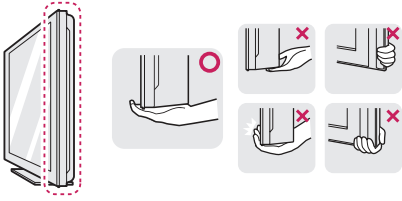

- When holding the monitor, the screen should face away from you to prevent it being scratched.

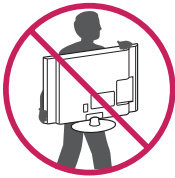

- When moving the monitor, avoid any strong shock or vibrations to the product.
- When moving the monitor, keep it upright, never turn the monitor on its side or tilt it sideways.

### CAUTION

- As far as possible, avoid touching the monitor screen. This may result in damage to the screen or some of the pixels used to create images.

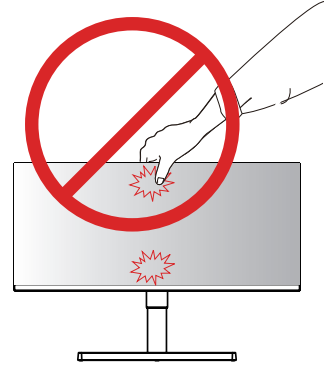

- If you use the monitor panel without the stand base, its joystick button may cause the monitor to become unstable and fall, resulting in damage to the monitor or human injury. In addition, this may cause the joystick button to malfunction.

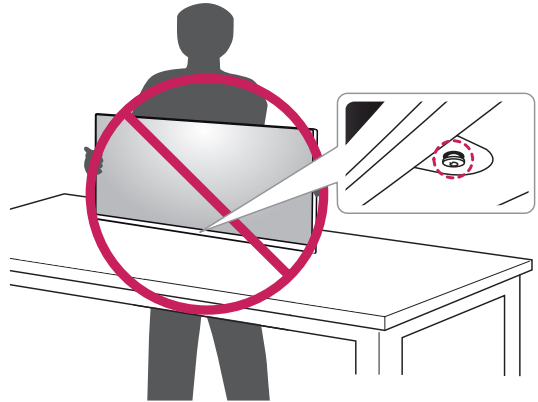



## Installing the Monitor

### Assembling the stand base

- 1 Please put a soft cloth on a low table or box to protect the screen of the monitor.

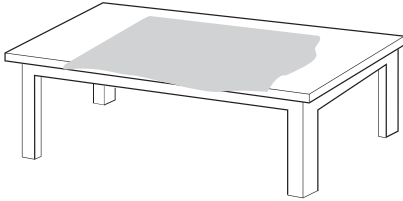

- 2 Please put the monitor on the soft cloth with the screen facing down.

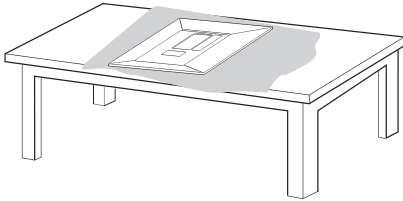

- 3 **1** Assemble the **Head** and **Stand body**.

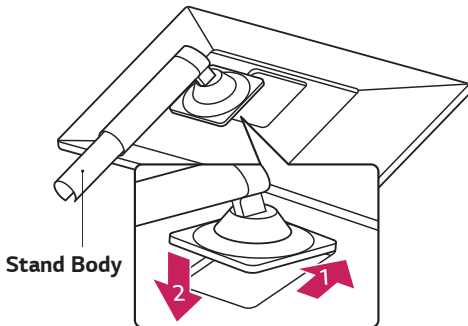

- 2 Assemble the **Stand body** and **Stand base**.

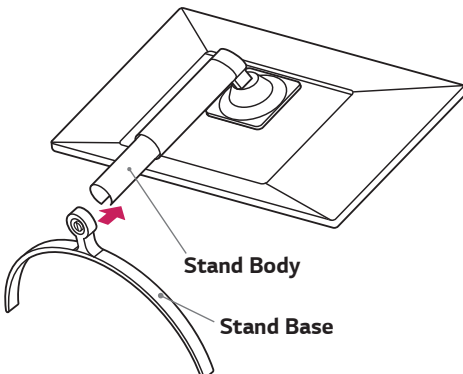

- 4 Turn the screw clockwise to secure the **stand base**.

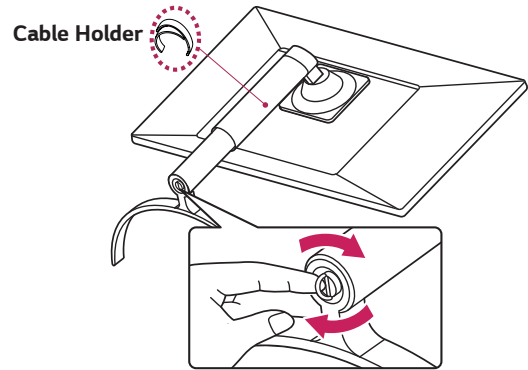

#### **CAUTION**

- To avoid injury to the fingers and foot when Assembly **Stand Body** and **Base**, should hold Base when assembly stand body and base.

#### **NOTE**

- Press the stand until the button reaches the top.

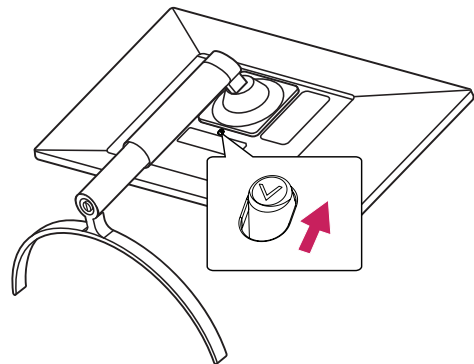

**CAUTION**

- Illustrations in this document represent typical procedures, so they may look different from the actual product.
- Do not carry the monitor upside down by just holding the stand base. This may cause the monitor to fall off the stand and could result in personal injury.
- When lifting or moving the monitor, do not touch the monitor screen. The force applied to the monitor screen may cause damage to it.
- Do not apply foreign substances (oils, lubricants, etc.) to the screw parts when assembling the product. (Doing so may damage the product.)
- Applying excessive force when tightening screws may cause damage to the monitor. Damage caused in this way will not be covered by the product warranty.

**NOTE**

- You can disassemble the stand in the reverse order of the assembly.

**Using the cable holder**

Arrange the cables using the cable holder as shown in the illustration.

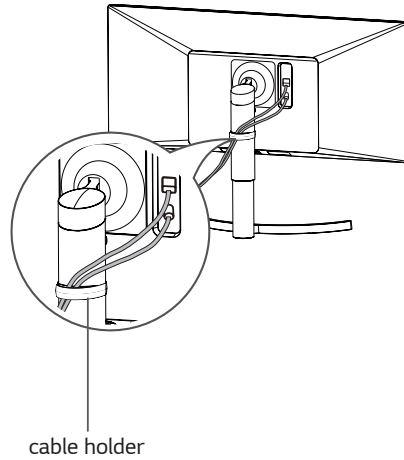

## Installing onto a table

- 1 Lift the monitor and place it on the table in an up-right position.

Place at least **100 mm** away from the wall to ensure sufficient ventilation.

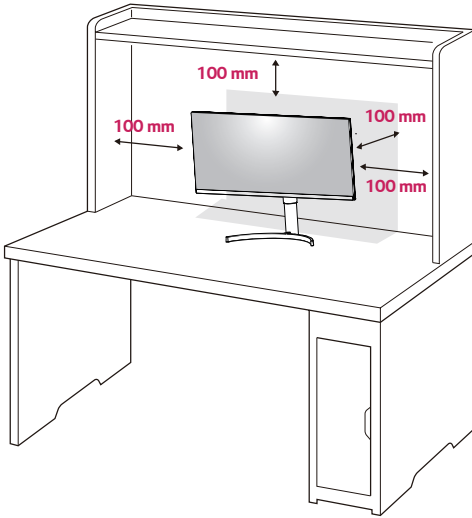

- 2 Connect the Power cord to the monitor, then plug the power cord into the wall outlet.

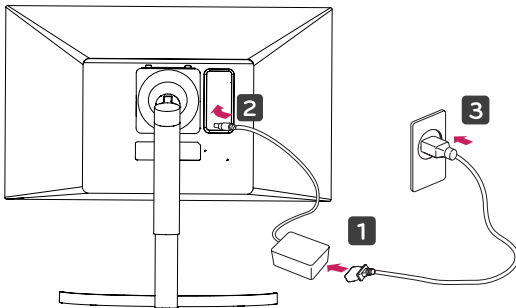

- 3 Press the joystick button on the bottom of the monitor to turn on the monitor.



### CAUTION

- Unplug the power cord prior to moving or installing the monitor. There is risk of electric shock.

## Cautions When Connecting Power Cord

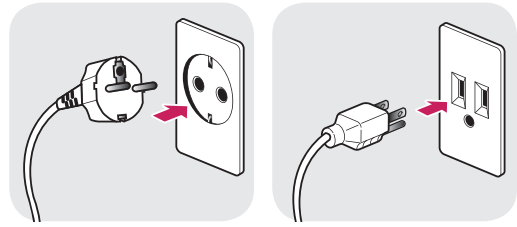

100-240 V~

- Make sure to use the power cord that is provided in the product package and connect it to a grounded power outlet.
- If you need another power cord, please contact your local dealer or the nearest retail store.

## Adjusting the angle

- 1 Place the monitor in an upright position, mounted on the stand base.
- 2 Adjust the angle of the screen. The angle of the screen can be adjusted forwards or backwards for a comfortable viewing experience.

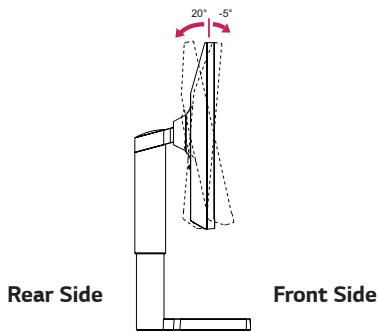

### **WARNING**

- To avoid injury to the fingers when adjusting the screen, do not hold the lower part of the monitor's frame as illustrated below.

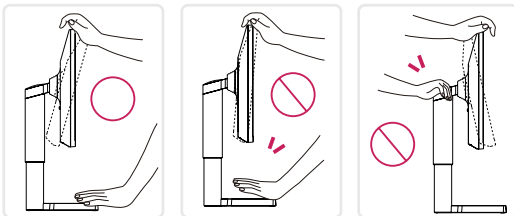

- Be careful not to touch or press the screen area when adjusting the angle of the monitor.

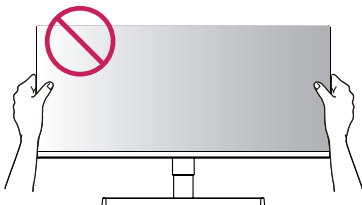

## Adjusting the Stand Height

- 1 Handle the monitor with both hands for safety.

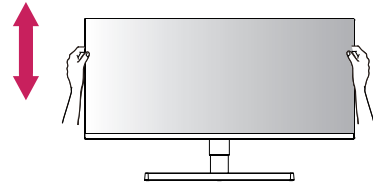

- 2 The height can be adjusted up to **110.0 mm**.

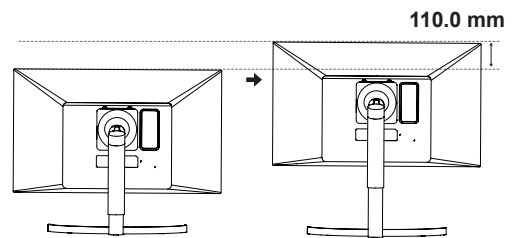

### **WARNING**

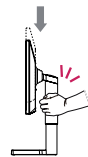

- Do not put your fingers or hand between the screen and the base (chassis) when adjusting the screen's height.

## Pivot Feature

The pivot feature allows the monitor to rotate 90° clockwise.

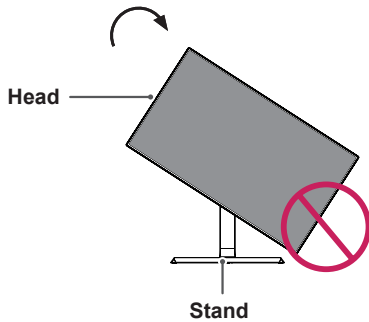

### WARNING

- To avoid scratching the stand base, make sure that when rotating the monitor using the pivot feature, the stand does not make contact with the monitor.

- 1 Raise the monitor to the maximum height.

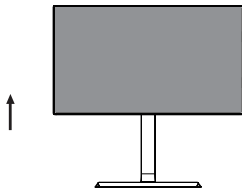

- 2 Adjust the angle of the monitor in the direction of the arrow as shown in the figure.

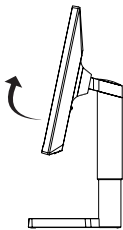

- 3 Rotate the monitor clockwise as shown in the figure.

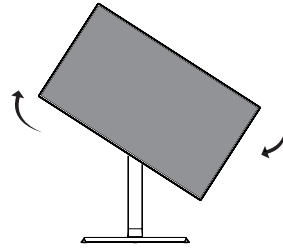

- 4 Complete the installation by rotating the monitor 90° as shown below.



### NOTE

- Auto Pivot feature of the display is not supported.
- The screen can be rotated easily using the screen pivot shortcut key provided with your Windows operating system. Note that some Windows versions and some graphics card drivers may use different settings for the screen pivot key or may not support the pivot key at all.

### WARNING

- Take care when rotating the monitor if the cable is connected.
- To avoid injury when rotating the display, do not place your fingers between the display and the stand base.

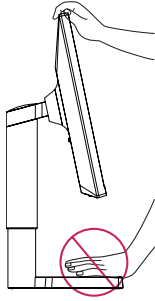

### NOTE

- The left or right side of the monitor head can be slightly rotated up or down (up to 3°). Adjust the horizontal level of the monitor head.

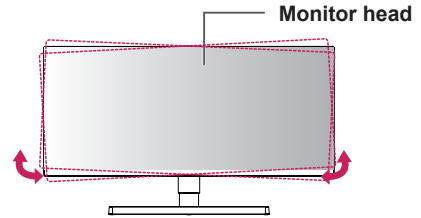

## Using the Kensington lock

The Kensington security system connector is located at the back of the Monitor set.

For more information on installation and usage, refer to the Kensington lock user manual or visit the website at <http://www.kensington.com>.

Connect the Kensington security system cable between the Monitor set and a table.

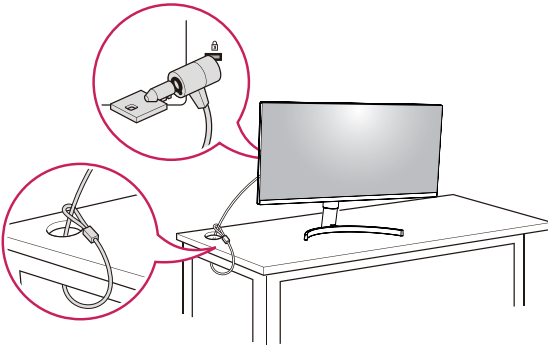

### NOTE

- Use of the Kensington lock is optional.  
The accessories can be purchased at your local electronics store.

## Detaching the Stand Body

- 1 Place the monitor's screen face down. To protect the screen from scratches, cover the surface with a soft cloth.
- 2 Remove the stand from the monitor by pressing the button on the bottom center of the back of the monitor.

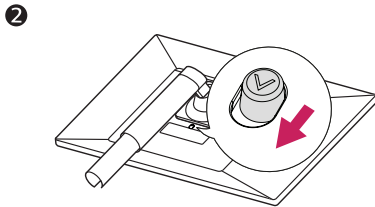
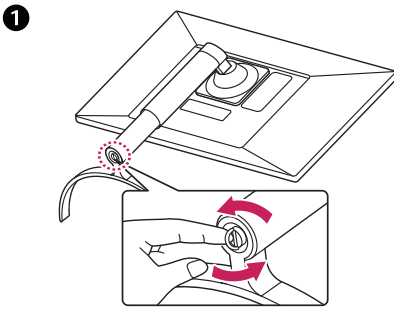

## Installing the wall mount plate

This monitor supports the specification of the standard wall mount plate or compatible device.

- 1 Place the screen face down. To protect the screen from scratches, cover the surface with a soft cloth.
- 2 Place the wall mount plate onto the monitor and align it with the screw holes.
- 3 Tighten the four screws to fix the plate to the monitor using a screwdriver.

### ! NOTE

- The wall mount plate is sold separately.
- For more information on installation, refer to the wall mount plate's installation guide.
- Be careful not to use excessive force when mounting the wall mount plate, as this can damage the monitor's screen.

## Installing to a wall

Install the monitor at least 100 mm away from the wall and leave about 100 mm of space at each side of the monitor to ensure sufficient ventilation. Detailed installation instructions can be obtained from your local retail store. Please refer to the manual to install and set up a tilting wall mounting bracket.

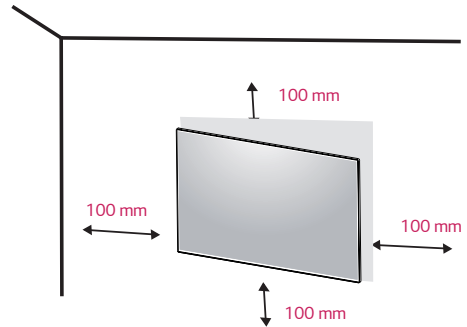

To install the monitor to a wall, attach a wall mounting bracket (optional) to the back of the monitor. Make sure that the wall mounting bracket is securely fixed to the monitor and to the wall.

- 1 If you use screw longer than standard, the monitor might be damaged internally.
- 2 If you use improper screw, the product might be damaged and drop from mounted position.  
In this case, LG Electronics is not responsible for it.

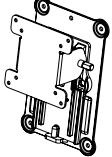
Wall Mount (A x B)	100 x 100
Standard screw	M4 x L10
Number of screws	4
Wall Mount Plate (Optional)	RW120 

- Wall Mount (A x B)

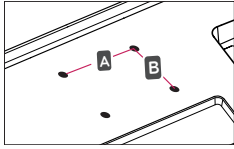

### CAUTION

- Unplug the power cord before moving or installing the monitor to avoid electric shocks.
- Installing the monitor on the ceiling or on a slanted wall may result in the monitor falling off, which could lead to injury. Please use the genuine LG wall mounting bracket. For more information, contact your local retail store or a qualified installer.
- Applying excessive force when fastening screws may cause damage to the monitor. Damage caused in this way will not be covered by the product warranty.
- Use the wall mounting bracket and screws that conform to the VESA standard. Damage caused by the use or misuse of inappropriate components will not be covered by the product warranty.
- Screw length from outer surface of back cover should be under Max. 8 mm.

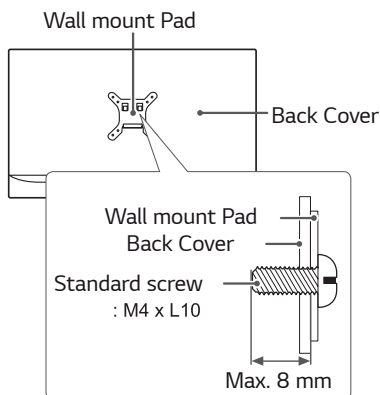

### NOTE

- Use the screws specified by the VESA standard.
- The wall mount kit includes the installation guide and all necessary parts.
- The wall mounting bracket is optional. The accessories can be purchased at your local retail store.
- The length of the screw may differ for each wall mounting bracket. Ensure the correct length screw is used.
- For more information, please refer to the user manual for the wall mounting bracket.



# USING THE MONITOR

## Connecting to a PC

- This monitor supports the \*Plug and Play feature.  
\*Plug and Play: A feature that allows you to add a device to your computer without having to reconfigure anything or install any manual drivers.

### HDMI connection

Transmits the digital video and audio signals from your PC and A/V devices to the monitor. Connect your PC and AV device to the monitor with the HDMI cable as illustrated below.

Press the menu button and then select the input option from the input menu.

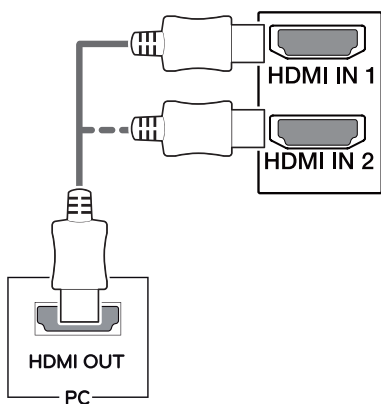

#### ! NOTE

- If you use HDMI PC, it can cause compatibility problem.
- Use a certified cable with the HDMI logo attached. If you do not use a certified HDMI cable, the screen may not display or a connection error may occur.
- Recommended HDMI cable types
  - High-Speed HDMI<sup>®</sup>/™ Cable
  - High-Speed HDMI<sup>®</sup>/™ Cable with Ethernet

### DisplayPort connection

Transmits the digital video and audio signals from your PC to the monitor. Connect your PC to the monitor using the Displayport cable as illustrated below.

Press the menu button and then select the input option from the input menu.

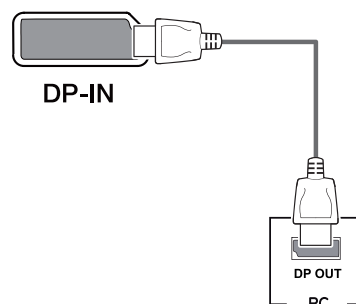

#### ! NOTE

- There may be no video or audio output depending on the DP version of the PC.
- If you use generic cables not certified by LG, the screen may not display or there may be image noises.
- For using Mini DP to DP (Mini DisplayPort to DisplayPort) cable, it is recommended that you use DisplayPort 1.2 cable.

## USB-C connection

Transmits digital video and audio signals from your PC to the monitor.

Connect the monitor to your PC using the USB-C cable as shown in the illustration below.

Press the menu button and then select the input option from the input menu.

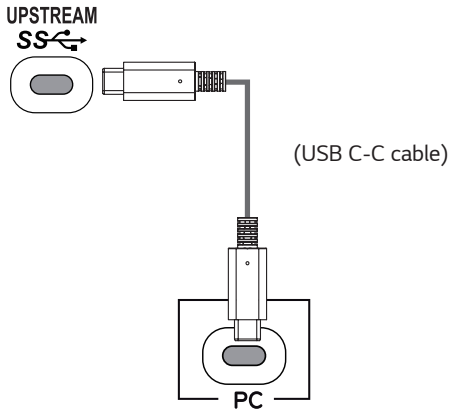

### ! NOTE

- PD(Power Delivery) and DP Alternate Mode(DP over USB-C) are supported via USB-C Port.
- Features may not work properly depending on the connected device's specifications and the environment.
- USB-C port is not for the Monitor Power source but for a PC power source.  
Connect Adapter to supply power to the Monitor

## Connecting to AV Devices

### HDMI connection

Transmits the digital video and audio signals from your PC and A/V devices to the monitor. Connect your PC and AV device to the monitor with the HDMI cable as illustrated below.

Press the menu button and then select the input option from the input menu.

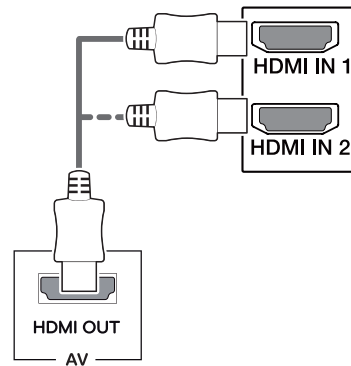

### ! NOTE

- Use a certified cable with the HDMI logo attached. If you do not use a certified HDMI cable, the screen may not display or a connection error may occur.
- Recommended HDMI cable types
  - High-Speed HDMI<sup>®/™</sup> Cable
  - High-Speed HDMI<sup>®/™</sup> Cable with Ethernet

## Connecting Peripherals

### USB Cable connection - PC

The USB port on the product functions as a USB hub.

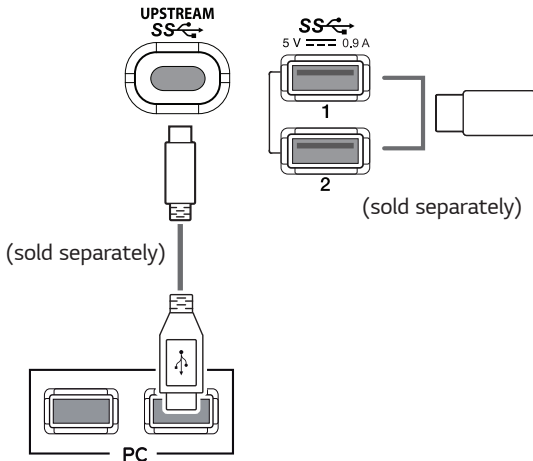

#### NOTE

- Make sure to install the most recent Windows OS service pack before using the product.
- Peripheral devices are sold separately.
- A keyboard, mouse, or USB device can be connected to the USB port.
- To use USB Downstream port of monitor, user must connect Upstream port of monitor to Host PC using USB C-C or USB C-A cable.
- When the USB C-C cable is connected between Upstream port of monitor and Host PC, the Downstream port of monitor support USB 2.0 device.
- When the USB C-A cable is connected between Upstream port of monitor and Host PC, the Downstream port of monitor support USB 3.0 device.  
However, Host PC must support USB 3.0 function.

#### CAUTION

Cautions When Using a USB Device

- A USB device with an automatic recognition program installed, or that uses its own driver, may not be recognized.
- Some USB devices may not be supported or may not work properly.
- It is recommended to use a USB hub or hard disk drive with power supplied. (If the power supply is not adequate, the USB device may not be recognized properly.)

## Connecting to External Devices

### Connecting Headphones

Connect peripherals to the monitor via the headphones port. Connect as illustrated.

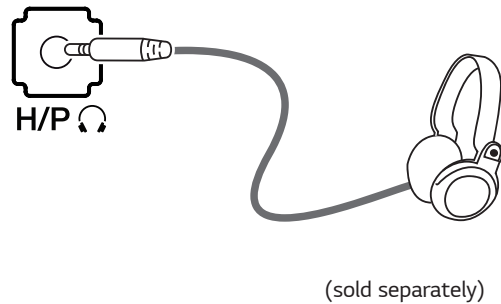

#### NOTE

- Peripheral devices are sold separately.
- If you use angled earphones, it may cause a problem with connecting another external device to the monitor. Therefore, it is recommended to use straight earphones.



Angled

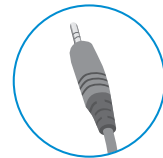

Straight



- Depending on the audio settings of the PC and external device, headphones and speaker functions may be limited.

# USER SETTINGS

## Activating the Main Menu

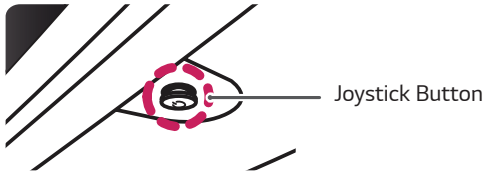
- 1 Press the joystick button on the bottom of the monitor.
- 2 To view the settings menu, press the joystick button at the bottom of the monitor and then enter the **Settings**.
- 3 Move the joystick up/down (▲/▼) and left/right(◀/▶) to set the options.
- 4 Press the joystick button once more to exit the main menu.



Button	Menu Status	Description
	<b>Main menu disabled</b>	Enables the main menu.
	<b>Main menu enabled</b>	Exits the main menu. (Holding down the button to turn off the monitor. You can turn off the monitor this way at any time, including when the OSD is on.)
	◀ <b>Main menu disabled</b>	Adjusts the monitor volume level.
	◀ <b>Main menu enabled</b>	Enters the <b>Input</b> feature.
	▶ <b>Main menu disabled</b>	Adjusts the monitor volume level.
	▶ <b>Main menu enabled</b>	Enters the <b>Settings</b> features.
	▲ <b>Main menu disabled</b>	Displays information on the current input.
	▲ <b>Main menu enabled</b>	Turns off the monitor.
	▼ <b>Main menu disabled</b>	Displays information on the current input.
	▼ <b>Main menu enabled</b>	Enters the <b>Game</b> features.

## Main Menu Features



Main Menu	Description
<b>Input</b>	Sets input mode.
<b>Power Off</b>	Turns off the monitor.
<b>Settings</b>	Configures the screen settings.
<b>Game</b>	Sets the game mode for gaming.
<b>Exit</b>	Exits the main menu.

## User Settings

### Menu Settings

- 1 To view the settings menu, press the joystick button at the bottom of the monitor and then enter the **Settings**.
- 2 Configure the options by moving the joystick up/down/left/right.
- 3 To return to the upper settings or set other settings items, move the joystick to ◀ or press (⌂).
- 4 If you want to exit the settings menu, move the joystick to ◀ until you exit.
  - When you enter the menu, instructions on how to use the button will appear in the bottom right corner of the screen.



Quick Settings



Input



Picture



Sound



General



#### CAUTION

- Your monitor's OSD (On Screen Display) may differ slightly from that shown in this manual.

Each option is described below.

Settings > Quick Settings	Description	
<b>Brightness</b>	Adjusts the color contrast and brightness of the screen.	
<b>Contrast</b>		
<b>Volume</b>	Adjusts the volume level.	
	 <b>NOTE</b> <ul style="list-style-type: none"> <li>• You can adjust Mute / Unmute by moving the joystick button to ▼ in the Volume menu.</li> </ul>	
<b>Color Temp</b>	<b>Custom</b>	The user can adjust it to red, green, or blue by customization.
	<b>Warm</b>	Sets the screen color to a reddish tone.
	<b>Medium</b>	Sets the screen color between a red and blue tone.
	<b>Cool</b>	Sets the screen color to a bluish tone.
<b>MaxxAudio</b>	<b>On</b>	MaxxAudio® by waves, recipient of a Technical GRAMMY Award® is a suite of studio-quality sound tools for a superior listening experience.
	<b>Off</b>	Disables the MaxxAudio function.

Settings > Input	Description	
<b>Input List</b>	Selects the input mode.	
<b>Aspect Ratio</b>	Adjusts the aspect ratio of the screen.	
	<b>Full Wide</b>	Displays the video in wide-screen, regardless of the video signal input.
	<b>Original</b>	Displays video according to the aspect ratio of the video signal input.
	<b>1:1</b>	The aspect ratio is not adjusted from the original.
	 <b>NOTE</b> <ul style="list-style-type: none"> <li>• The display may look the same for Full Wide , Original, and 1:1 options at the recommended resolution (3840 x 2160).</li> <li>• There is no 1:1 menu on <b>FreeSync</b> Mode. ( Go to <b>Picture</b> → <b>Game Adjust</b> → <b>FreeSync</b>, to set from <b>FreeSync Basic</b> or <b>Extended</b> to <b>Off</b>)</li> </ul>	

Picture Mode on SDR(Non-HDR) signal.

Settings > Picture	Description	
Picture Mode	Custom	Allows the user to adjust each element. The color mode of the main menu can be adjusted.
	Reader	Optimizes the screen for viewing documents. You can brighten the screen in the OSD menu.
	Photo	Optimizes the screen for photos.
	Cinema	Optimizes the screen for video.
	HDR Effect	Optimizes the screen for high dynamic range.
	Dark Room 1	This mode adjusts the brightness to the optimal level for working in a dark environment.
	Dark Room 2	This mode sets the brightness to a lower level than Dark Room 1.
	Color Weakness	This mode is for users who cannot distinguish between red and green. It enables users with color weakness to easily distinguish between the two colors.
	FPS Game 1	This mode is optimized for FPS games.
	FPS Game 2	It has a higher Black Stabilizer value than FPS Game 1. It is suitable for very dark FPS games.
	RTS Game	This mode is optimized for RTS Game.
	Custom (Game)	In this mode, users can customize various elements including game-related options.
	EBU	A standard TV PAL color space for broadcasting.
	REC709	A standard HDTV color space for broadcasting.
	SMPTE-C	A standard TV NTSC color space for broadcasting.
	Calibration 1	Adjusts to the last calibrated screen.
Calibration 2	Adjusts to the previously calibrated screen.	



### NOTE

- If the **picture mode** is changed, the screen may flicker or the resolution of your PC screen may be affected.
- **Calibration 2** : Installation of TRUE COLOR PRO and proceeding **Calibration** will enable this menu.



Picture Mode on HDR signal.

Settings > Picture	Description	
Picture Mode	HDR Vivid	Optimized the screen for HDR vivid colors.
	HDR Standard	Optimized the screen for HDR.
	HDR Game	Optimized the screen for HDR Games.
	HDR Cinema	Optimized the screen for HDR video.



### NOTE



- HDR content may not be operated properly depending on the Windows10 OS setting. Please check the HDR On / Off setting of Windows.
- When the HDR function is turned on, the characters or picture quality may be poor according to Graphic card performance.
- While the HDR function is on, screen flickering or cracking may occur when changing the monitor input or power on/off according to Graphic card performance.

Picture Adjust	<b>Brightness</b>	Adjusts the brightness of the screen.		
	<b>Contrast</b>	Adjusts the contrast of the screen.		
	<b>Sharpness</b>	Adjusts the sharpness of the screen.		
	<b>SUPER RESOLUTION+</b>	<b>High</b>	Optimized picture quality is displayed when a user wants crystal clear images. It is effective for high quality video or game.	
		<b>Middle</b>	The optimized picture quality is displayed when a user wants images between low and high modes for comfortable viewing. It is effective for UCC or SD video.	
		<b>Low</b>	The optimized picture quality is displayed when a user wants smooth and natural images. It is effective for slow-moving pictures or still images.	
		<b>Off</b>	Select this option for everyday viewing. SUPER RESOLUTION+ is turned off in this mode.	
		 <b>NOTE</b>		<ul style="list-style-type: none"> <li>Because this is a function to increase the sharpness of low resolution pictures, it is not recommended to use the function for normal text or for desktop icons. Doing so may result in unnecessarily high sharpness.</li> </ul>
	<b>Black Level</b>	Sets the offset level (for HDMI only). <ul style="list-style-type: none"> <li>Offset: as a reference for a video signal, this is the darkest color the monitor can display.</li> </ul>		
		<b>High</b>	Keeps the current contrast ratio of the screen.	
		<b>Low</b>	Lowers the black levels and raises the white levels from the current contrast ratio of the screen.	
	<b>HDMI ULTRA HD Deep Color</b>	Provides sharper images when connected to a device supporting ULTRA HD Deep Color.		
		<b>4K@60 Hz Support Format (HDMI ULTRA HD Deep Color On)</b>		
		<b>Resolution</b>	<b>Frame rate (Hz)</b>	<b>Color Depth / Chroma Sampling</b>
				<b>8 bit</b> <b>10 bit</b>
3840 x 2160		59.94 60.00	YCbCr 4:2:0	
			YCbCr 4:2:2	
			YCbCr 4:4:4	-
			RGB	-
<b>4K@30 Hz Support Format (HDMI ULTRA HD Deep Color Off)</b>				
<b>Resolution</b>		<b>Frame rate (Hz)</b>	<b>Color Depth / Chroma Sampling</b>	
		<b>8 bit</b> <b>10 bit</b>		
3840 x 2160	29.97 30.00	YCbCr 4:2:2		
		YCbCr 4:4:4	-	
		RGB	-	
 <b>NOTE</b>		<ul style="list-style-type: none"> <li>If the connected device does not support ULTRA HD Deep Color, the feature may not work properly.</li> <li>If a problem occurs, set the HDMI ULTRA HD Deep Color option to Off.</li> <li>HDMI ULTRA HD Deep Color option must be set for each HDMI port (HDMI IN 1, HDMI IN 2) separately.</li> <li>HDMI ULTRA HD Deep Color option can be changed with SET OSD Menu. (Settings - Picture - Picture Adjust - HDMI ULTRA HD Deep Color Off / On)</li> </ul>		
<b>DFC</b>	<b>On</b>	Adjusts the brightness automatically according to the screen.		
	<b>Off</b>	Disables the <b>DFC</b> feature.		

Game Adjust	Response Time	Sets a response time for displayed pictures based on the speed of the screen. For a normal environment, it is recommended that you use <b>Fast</b> . For a fast-moving picture, it is recommended that you use <b>Faster</b> . Setting to <b>Faster</b> may cause image sticking.		
		<b>Faster</b>	Sets the response time to faster.	
		<b>Fast</b>	Sets the response time to fast.	
		<b>Normal</b>	Sets the response time to normal.	
		<b>Off</b>	Does not use the response time improvement feature.	
	FreeSync	Provides seamless and natural images by synchronizing the vertical frequency of the input signal with that of the output signal.  <b>CAUTION</b>		
		<ul style="list-style-type: none"> <li>Supported Interface: DisplayPort,HDMI.</li> <li>Supported Graphic Card : A graphic card that supports AMD's FreeSync is necessary.</li> <li>Supported Version : Make sure to update the graphic card to the latest driver.</li> <li>For more information and requirement, refer to AMD website at <a href="http://www.amd.com/FreeSync">http://www.amd.com/FreeSync</a></li> </ul>		
		<b>Extended</b>	Enable wider frequency range of FreeSync function than basic mode. The screen may flicker during the game play.	
		<b>Basic</b>	Enable basic frequency range of FreeSync function.	
	Black Stabilizer	<b>Off</b>		
FreeSync function off.				
Color Adjust	Gamma	<b>Mode 1, Mode 2, Mode 3</b>	The higher the gamma value, the darker the image becomes. Likewise, the lower the gamma value, the lighter the image becomes.	
		<b>Mode 4</b>	If you do not need to adjust the gamma settings, select Mode 4.	
		The user can adjust it to red, green, or blue by customization.		
	Color Temp	<b>Custom</b>	The user can adjust it to red, green, or blue by customization.	
		<b>Warm</b>	Sets the screen color to a reddish tone.	
		<b>Medium</b>	Sets the screen color between a red and blue tone.	
		<b>Cool</b>	Sets the screen color to a bluish tone.	
	Red	You can customize the picture color using <b>Red</b> , <b>Green</b> , and <b>Blue</b> colors.		
	Green			
	Blue			
Six Color	Meets the user requirements for colors through adjusting the color and saturation of the six colors( <b>Red_Hue, Red_Saturation, Green_Hue, Green_Saturation, Blue_Hue, Blue_Saturation, Cyan_Hue, Cyan_Saturation, Magenta_Hue, Magenta_Saturation, Yellow_Hue, Yellow_Saturation</b> ) and saving the settings.			
	<b>Hue</b>	Adjusts the tone of the screen colors.		
	<b>Saturation</b>	Adjusts the saturation of the screen colors. The lower the value, the less saturated and brighter the colors become. The higher the value, the more saturated and darker the colors become.		
Picture Reset	<b>Do you want to Picture reset your settings?</b>			
	<b>No</b>	Cancel the select.		
	<b>Yes</b>	Returns to the default settings.		



Settings > Sound	Description	
<b>Volume</b>	Adjusts the volume level.	
	 <b>NOTE</b> <ul style="list-style-type: none"> <li>You can adjust <b>Mute / Unmute</b> by moving the joystick button to ▼ in the <b>Volume</b> menu.</li> </ul>	
<b>MaxxAudio</b>	<b>On</b>	MaxxAudio® by waves, recipient of a Technical GRAMMY Award® is a suite of studio-quality sound tools for a superior listening experience.
	<b>Off</b>	Disables the MaxxAudio function.

Settings > General	Description	
<b>Language</b>	Sets the menu screen to the desired language.	
<b>SMART ENERGY SAVING</b>	<b>High</b>	Saves energy using the high-efficiency SMART ENERGY SAVING feature.
	<b>Low</b>	Saves energy using the low-efficiency SMART ENERGY SAVING feature.
	<b>Off</b>	Disables the SMART ENERGY SAVING feature.
<b>Power LED</b>	Turns the power LED on the bottom of the monitor on or off.	
	<b>On</b>	The power LED turns on automatically.
	<b>Off</b>	The power LED turns off.
<b>Automatic Standby</b>	Feature that automatically turns off the monitor when there is no movement on the screen for a period of time. You can set a timer for the auto-off function. (Off, 4 H, 6 H, and 8 H)	
<b>DisplayPort 1.2</b>	Enables or disables DisplayPort 1.2.	
	 <b>NOTE</b> <ul style="list-style-type: none"> <li>Be sure to configure this option according to the DisplayPort version supported by your graphics card. Set this option to Disable if your graphics card does not support DisplayPort 1.2.</li> </ul>	
<b>Buzzer</b>	This feature lets you set the sound generated from Buzzer when your monitor powers on.	
	<b>On</b>	Enables your monitor's <b>Buzzer</b> .
	<b>Off</b>	Disables your monitor's <b>Buzzer</b> .
<b>OSD Lock</b>	This feature disables the configuration and adjustment of menus.	
	<b>On</b>	Enables OSD Lock.
	<b>Off</b>	Disables OSD Lock.
	 <b>NOTE</b> <ul style="list-style-type: none"> <li>All features are disabled except Brightness, Contrast, Volume, Input List, Aspect Ratio, OSD Lock and Information.</li> </ul>	
<b>OSD Size</b>	User can select OSD Size to Large or Small.	
<b>Deep Sleep Mode</b>	When Deep sleep mode is enabled, power consumption is minimized while the monitor is in standby mode.	
	<b>On</b>	Enables Deep sleep Mode.
	<b>Off</b>	Disables Deep sleep Mode.
	 <b>NOTE</b> <ul style="list-style-type: none"> <li>USB HUB functions will not work in standby mode while Deep sleep Mode is enabled in standby mode.</li> </ul>	
<b>Information</b>	The display information will be shown the Model, Serial Number, Total Power On Time, Resolution.	
<b>Reset</b>	<b>Do you want to reset your settings?</b>	
	<b>No</b>	Cancel the select.
	<b>Yes</b>	Returns to the default settings.

 **NOTE**

- Saving Data depends on the Panel. So, these values may be different from each panel and/or panel vendor. If the SMART ENERGY SAVING option is High or Low, monitor luminance become higher or lower depending on the source.

# TROUBLESHOOTING

Nothing is displayed on the screen.	
Is the monitor's power cord plugged in?	<ul style="list-style-type: none"> <li>• Check if the power cord is correctly plugged into the power outlet.</li> </ul>
Is the power LED on?	<ul style="list-style-type: none"> <li>• Check the power cable connection and press the power button.</li> </ul>
Is the power on and the power LED displaying white?	<ul style="list-style-type: none"> <li>• Check that the connected input is enabled (Settings &gt; Input &gt; Input list).</li> </ul>
Is the OUT OF RANGE message being displayed?	<ul style="list-style-type: none"> <li>• This occurs when signals transferred from the PC (graphics card) are out of the horizontal or vertical frequency range of the monitor. Please see the Product Specification section of this manual to set the appropriate frequency.</li> </ul>
Is the No Signal message being displayed?	<ul style="list-style-type: none"> <li>• This is displayed when the signal cable between the PC and the monitor is missing or disconnected. Check the cable and reconnect it.</li> </ul>

The OSD lock message is being displayed.	
Are some functions not available when you press the Menu button?	<ul style="list-style-type: none"> <li>• The OSD is locked. Go to Settings &gt; General and set OSD Lock to Off.</li> </ul>

The screen retains an image.	
Does image sticking occur even when the monitor is turned off?	<ul style="list-style-type: none"> <li>• Displaying a still image for a prolonged time may cause damage to the screen, resulting in the retention of the image.</li> <li>• To extend the lifetime of the monitor, use a screensaver.</li> </ul>

Screen display is unstable and shaky / Images displayed on the monitor leave shadow trails.	
Did you select the appropriate resolution?	<ul style="list-style-type: none"> <li>• If the selected resolution is HDMI 1080i 60/50 Hz (interlaced), the screen may be flickering. Change the resolution to 1080P or the recommended resolution.</li> </ul>



## NOTE

- **Vertical frequency** In order to display an image, the screen must be refreshed dozens of times per second, like a fluorescent lamp. The number of times the screen is refreshed per second is called vertical frequency, or refresh rate, and is represented by Hz.
- **Horizontal frequency** The time it takes to display one horizontal line is called the horizontal cycle. If 1 is divided by the horizontal interval, the result is the number of horizontal lines displayed per second. This is called horizontal frequency and is represented by kHz.
- LED can be lighted with Set OSD Menu.  
Settings – General – Power LED – On

 **NOTE**

- Check if the graphics card's resolution or frequency is within the range allowed by the monitor and set it to the recommended (optimal) resolution in **Control Panel > Display > settings**.
- Not setting the graphics card to the recommended (optimal) resolution may result in blurred text, a dimmed screen, a truncated display area, or misalignment of the display.
- The setting methods may be different depending on the computer or operating system, and some resolutions may not be available depending on the performance of the graphics card. If this is the case, contact the manufacturer of the computer or graphics card for assistance.
- Some graphics cards may not support 3840 x 2160 resolution. If the resolution cannot be displayed, contact the manufacturer of your graphics card.

<b>The display color is abnormal.</b>	
Does the display appear discolored (16 colors)?	<ul style="list-style-type: none"> <li>• Set the color to 24 bit (true color) or higher. In Windows, go to Control Panel &gt; Display &gt; Settings &gt; Color Quality.</li> </ul>
Does the display color appear unstable or monochrome?	<ul style="list-style-type: none"> <li>• Check if the signal cable is connected properly. Reconnect the cable or reinsert the PC's graphics card.</li> </ul>
Are there spots on the screen?	<ul style="list-style-type: none"> <li>• When using the monitor, pixilated spots (red, green, blue, white, or black) may appear on the screen. This is normal for an LCD screen. It is not an error, nor is it related to the monitor's performance.</li> </ul>

<b>Do you see an "Unrecognized monitor, Plug&amp;Play (VESA DDC) monitor found" message?</b>	
Have you installed the display driver?	<ul style="list-style-type: none"> <li>• Be sure to install the display driver from the display driver CD (or diskette) that comes with your display. Or, you can also download the driver from our web site: <a href="http://www.lg.com">http://www.lg.com</a>.</li> <li>• Make sure to check if the video card supports Plug&amp;Play function.</li> </ul>

<b>No sound from the headphone port or speaker.</b>	
Are images displayed using DisplayPort or HDMI input without sound?	<ul style="list-style-type: none"> <li>• Try increasing the volume using the button on the monitor.</li> <li>• Set the audio output of the PC to the monitor you are using. On Microsoft Windows, go to Control Panel &gt; Hardware and Sound &gt; Sound &gt; set the monitor as default device.</li> </ul>

# SPECIFICATIONS

## 27UK850/27BK85U

LCD Screen	Type	TFT (Thin Film Transistor) LCD (Liquid Crystal Display) Screen
	Sub Pixel Pitch	0.1554 mm x 0.1554 mm
Resolution	Maximum Resolution	3840 x 2160 @ 60 Hz
	Recommended Resolution	3840 x 2160 @ 60 Hz
Video Signal	Horizontal Frequency	30 kHz to 135 kHz
	Vertical Frequency	56 Hz to 61 Hz
Input Connector	HDMI IN1, HDMI IN2 , DP(DisplayPort) IN, H/P, USB-C,USB (SS⇄) 1/2	
Power input	19 V --- 7.0 A	
Power consumption (Typ.)	On mode: 32 W Typ. (ENERGY STAR® standard)* 50 W Typ. (Outgoing condition)** Sleep Mode ≤ 0.5 W Off Mode ≤ 0.3 W	
AC/DC adaptor	Type A16-140P1A, CHICONY POWER TECHNOLOGY(SUZHOU)CO.,LTD. Output: 19 V --- 7.37 A	
Environmental Conditions	Operating Condition	Temperature: 0 °C to 40 °C; Humidity: < 80%
	Storing Condition	Temperature: -20 °C to 60 °C; Humidity: < 85%
Dimension	Monitor Size (Width x Height x Depth)	
	With Stand	613.1 mm x 559.5 mm x 234.2 mm
	Without Stand	613.1 mm x 364.4 mm x 44.6 mm
Weight (Without Packaging)	With Stand	6.1 kg
	Without Stand	4.8 kg

The specifications are subject to change without notice.

\* The power consumption level can be different by operating condition and monitor setting.

\* The On mode power consumption is measured with ENERGY STAR® test standard.

\*\* The On mode power consumption is measured with LGE test standard (Full White pattern , Maximum resolution).

## Factory Support Mode (Preset Mode, PC)

### HDMI

Display Modes (Resolution)	Horizontal Frequency(kHz)	Vertical Frequency(Hz)	Polarity(H/V)	Remarks
640 x 480	31.469	59.94	-/-	
800 x 600	37.879	60.317	+/+	
1024 x 768	48.363	60	-/-	
1152 x 864	54.347	60.05	+/+	
1280 x 720	45	60	+/+	
1280 x 800	49.702	59.810	-/+	
1280 x 1024	63.981	60.02	+/+	
1600 x 900	60	60	+/+	
1920 x 1080	67.5	60	+/-	
2560 x 1440	88.79	59.95	+/-	
3840 x 2160	67.5	30	+/-	
3840 x 2160	135	60	+/-	When HDMI ULTRA HD Deep Color is set to ON

### DisplayPort / USB-C

Display Modes (Resolution)	Horizontal Frequency(kHz)	Vertical Frequency(Hz)	Polarity(H/V)	Remarks
640 x 480	31.469	59.94	-/-	
800 x 600	37.879	60.317	+/+	
1024 x 768	48.363	60	-/-	
1152 x 864	54.347	60.05	+/+	
1280 x 720	45	60	+/+	
1280 x 800	49.702	59.810	-/+	
1280 x 1024	63.981	60.02	+/+	
1600 x 900	60	60	+/+	
1920 x 1080	67.5	60	+/-	
2560 x 1440	88.79	59.95	+/-	
3840 x 2160	66.66	30	+/-	
3840 x 2160	133.32	60	+/-	

## HDMI Timing (Video)

Factory support mode (Preset Mode)	Horizontal Frequency(kHz)	Vertical Frequency(Hz)	Remarks
480p	31.5	60	
720p	45.0	60	
1080p	67.5	60	
2160p	135	60	When HDMI ULTRA HD Deep Color is set to ON

## Power LED

Mode	LED Color
On Mode	White (For a few seconds)
Sleep Mode	Off
Off Mode	Off



To obtain the source code under GPL, LGPL, MPL, and other open source licenses, that is contained in this product, please visit <http://opensource.lge.com>. In addition to the source code, all referred license terms, warranty disclaimers and copyright notices are available for download. LG Electronics will also provide open source code to you on CD-ROM for a charge covering the cost of performing such distribution (such as the cost of media, shipping, and handling) upon email request to [opensource@lge.com](mailto:opensource@lge.com). This offer is valid for three (3) years from the date on which you purchased the product.

This device meets the EMC requirements for home appliances (Class B) and is intended for home usage. This device can be used in all regions. Read the owner's manual (CD) carefully and keep it at hand. Please note that the label attached to the product provides information for technical support.

**MODEL** \_\_\_\_\_

**SERIAL** \_\_\_\_\_

ENERGY STAR is a set of power-saving guidelines issued by the U.S. Environmental Protection Agency (EPA).



As an ENERGY STAR Partner LGE U. S. A., Inc. has determined that this product meets the ENERGY STAR guidelines for energy efficiency.

Refer to [ENERGY STAR.gov](http://ENERGY STAR.gov) for more information on the ENERGY STAR program.