

# Acer Projector

H7850/V7850/H6815/V6815/E270/V270/  
E8615/E8615C/HE-4K20/HT-4K20/  
ET-4K15/HT-4K15/M550/V550/  
GM834/HV834/VH-735/TH-735/D4K1701/  
D4K1702/D4K1735/D4K1732

User's Guide

Copyright © 2017. Acer Incorporated.  
All Rights Reserved.

Acer Projector User's Guide  
Original Issue: 03/2017

Changes may be made periodically to the information in this publication without obligation to notify any person of such revisions or changes. Such changes will be incorporated in new editions of this manual or supplementary documents and publications. This company makes no representations or warranties, either expressed or implied, with respect to the contents hereof and specifically disclaims the implied warranties of merchantability or fitness for a particular purpose.

Record the model number, serial number, purchase date and place of purchase information in the space provided below. The serial number and model number are recorded on the label affixed to your projector. All correspondence concerning your unit should include the serial number, model number and purchase information.

No part of this publication may be reproduced, stored in a retrieval system, or transmitted, in any form or by any means, electronically, mechanically, by photocopy, recording or otherwise, without the prior written permission of Acer Incorporated.

Model number: \_\_\_\_\_

Serial number: \_\_\_\_\_

Date of purchase: \_\_\_\_\_

Place of purchase: \_\_\_\_\_

Acer and the Acer logo are registered trademarks of Acer Incorporated. Other companies' product names or trademarks are used herein for identification purposes only and belong to their respective companies.

"HDMI™, the HDMI logo and High-Definition Multimedia Interface are trademarks or registered trademarks of HDMI Licensing LLC."



# Information for your safety and comfort

Read these instructions carefully. Keep this document for future reference. Follow all warnings and instructions marked on the product.

## Turning the product off before cleaning

Unplug this product from the wall outlet before cleaning. Do not use liquid cleaners or aerosol cleaners. Use a damp cloth for cleaning.

## Caution for plug as disconnecting device

Observe the following guidelines when connecting and disconnecting power to the external power supply unit:

- Install the power supply unit before connecting the power cord to the AC power outlet.
- Unplug the power cord before removing the power supply unit from the projector.
- If the system has multiple sources of power, disconnect power from the system by unplugging all power cords from the power supplies.

## Caution for Accessibility

Be sure that the power outlet you plug the power cord into is easily accessible and located as close to the equipment operator as possible. When you need to disconnect power to the equipment, be sure to unplug the power cord from the electrical outlet.



### Warnings!

- Do not use this product near water.
- Do not place this product on an unstable cart, stand or table. If the product falls, it could be seriously damaged.
- Slots and openings are provided for ventilation to ensure reliable operation of the product and to protect it from overheating. These openings must not be blocked or covered. The openings should never be blocked by placing the product on a bed, sofa, rug or other similar surface.
- This product should never be placed near or over a radiator or heat register, or in a built-in installation unless proper ventilation is provided.
- Never push objects of any kind into this product through cabinet slots as they may touch dangerous voltage points or short-out parts that could result in a fire or electric shock. Never spill liquid of any kind onto or into the product.
- To avoid damage of internal components and to prevent battery leakage, do not place the product on a vibrating surface.

- Never use it under sporting, exercising, or any vibrating environment which will probably cause unexpected short current or damage rotor devices, lamp.

## Using electrical power

- This product should be operated from the type of power indicated on the marking label. If you are not sure of the type of power available, consult your dealer or local power company.
- Do not allow anything to rest on the power cord. Do not locate this product where people will walk on the cord.
- If an extension cord is used with this product, make sure that the total ampere rating of the equipment plugged into the extension cord does not exceed the extension cord ampere rating. Also, make sure that the total rating of all products plugged into the wall outlet does not exceed the fuse rating.
- Do not overload a power outlet, strip or receptacle by plugging in too many devices. The overall system load must not exceed 80% of the branch circuit rating. If power strips are used, the load should not exceed 80% of the power strip's input rating.
- This product's AC adapter is equipped with a three-wire grounded plug. The plug only fits in a grounded power outlet. Make sure the power outlet is properly grounded before inserting the AC adapter plug. Do not insert the plug into a non-grounded power outlet. Contact your electrician for details.



.....

**Warning! The grounding pin is a safety feature. Using a power outlet that is not properly grounded may result in electric shock and/or injury.**



.....

**Note: The grounding pin also provides good protection from unexpected noise produced by other nearby electrical devices that may interfere with the performance of this product.**

- Use the product only with the supplied power supply cord set. If you need to replace the power cord set, make sure that the new power cord meets the following requirements: detachable type, UL listed/CSA certified, VDE approved or its equivalent, 4.5 meters (15 feet) maximum length.

## Product servicing

Do not attempt to service this product yourself, as opening or removing covers may expose you to dangerous voltage points or other risks. Refer all servicing to qualified service personnel.

Unplug this product from the wall outlet and refer servicing to qualified service personnel when:

- the power cord or plug is damaged, cut or frayed
- liquid was spilled into the product
- the product was exposed to rain or water
- the product has been dropped or the case has been damaged
- the product exhibits a distinct change in performance, indicating a need for service
- the product does not operate normally after following the operating instructions



.....

**Note: Adjust only those controls that are covered by the operating instructions, since improper adjustment of other controls may result in damage and will often require extensive work by a qualified technician to restore the product to normal condition.**



.....

**Warning! For safety reasons, do not use non-compliant parts when adding or changing components. Consult your reseller for purchase options.**

Your device and its enhancements may contain small parts. Keep them out of the reach of small children.

## Additional safety information

- Do not look into the projector's lens when the lamp is on. The bright may hurt your eyes.
- Turn on the projector first and then signal sources
- Do not place the product in following environments:
  - Space that is poorly ventilated or confined. At least 50cm clearance from walls and free flow of air around the projector is necessary.
  - Locations where temperatures may become excessively high, such as inside of a car with all windows rolled up.
  - Locations where excessive humidity, dust, or cigarette smoke may contaminate optical components, shortening the life span and darkening the image.
  - Locations near fire alarms.
  - Locations with an ambient temperature above 40 °C/104 °F.
  - Locations where the altitudes are higher than 10000 feet.
- Unplug immediately if there is something wrong with your projector. Do not operate if smoke, strange noise or odor comes out of your projector. It might cause fire or electric shock. In this case, unplug immediately and contact your dealer.
- Do not keep using this product to break or drop it. In this case contact your dealer for inspection.
- Do not face the projector lens to the sun. It can lead to fire.
- When switching the projector off, suggest to ensure the projector completes its cooling cycle before disconnecting power.
- Do not frequently turn off the main power abruptly or unplug the projector during operation. The best way is to wait for the fan to turn off

before turning main power off.

- Do not touch air outlet grille and bottom plate which becomes hot.
- Do not look into the air outlet grille when projector is operating. It may hurt your eyes.
- Always open the lens shutter or remove the lens cap when the projector is on.
- Do not block the projector lens with any object when the projector is under operation as this could cause the object to become heated and deformed or even cause a fire. To temporarily turn off the lamp, press **HIDE** on the remote control.
- The lamp becomes extremely hot during operation. Allow the projector to cool for approximately 45 minutes prior to removing the lamp assembly for replacement.
- Do not operate lamps beyond the rated lamp life. It could cause it to break on rare occasions.
- Never replace the lamp assembly or any electronic components unless the projector is unplugged.
- The product will detect the life of the lamp itself. Please be sure to change the lamp when is showing warning message.
- When changing the lamp, please allow unit to cool down, and follow all changing instructions.
- Reset the "Lamp Hour Reset" function from the Onscreen display "Management" menu after replacing the lamp module.
- Do not attempt to disassemble this projector. There are dangerous high voltages inside which may hurt you. The only user serviceable part is the lamp which has its own removable cover. Refer servicing only to suitable qualified professional service personnel.
- Do not stand the projector on end vertically. It may cause the projector to fall over, causing injury or damage.
- This product is capable of displaying inverted images for ceiling mount installation. Only use acer ceiling mount kit for mounting the projector and ensure it is securely installed.
- The projector should be placed in a horizontal way by means of desktop or ceiling mount mode only, and its tilt angles should not exceed 6 degrees, otherwise it would cause dramatical decrease of lamp life or severe safety concern of system malfunction.



## Caution for Listening

To protect your hearing, follow these instructions.

- Increase the volume gradually until you can hear clearly and comfortably.
- Do not increase the volume level after your ears have adjusted.
- Do not listen to music at high volumes for extended periods.
- Do not increase the volume to block out noisy surroundings.
- Decrease the volume if you can't hear people speaking near you.

## Disposal instructions

Do not throw this electronic device into the trash when discarding. To minimize pollution and ensure utmost protection of the global environment, please recycle. For more information on the Waste from Electrical and Electronics Equipment (WEEE) regulations, visit

<http://www.acer-group.com/public/Sustainability/sustainability01.htm>



## Mercury advisory

For projectors or electronic products containing an LCD/CRT monitor or display:

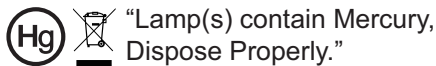

Lamp(s) inside this product contain mercury and must be recycled or disposed of according to local, state or federal laws. For more information, contact the Electronic Industries Alliance at [www.eiae.org](http://www.eiae.org). For lamp-specific disposal information, check [www.lamprecycle.org](http://www.lamprecycle.org)



## Do not stare into the beam, RG2

"As with any bright source, do not stare into the direct beam, RG2 IEC 62471-5:2015"

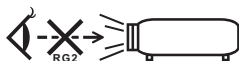

# First things first

## Usage Notes

Do:

- Turn off the product before cleaning.
- Use a soft cloth moistened with mild detergent to clean the display housing.
- Disconnect the power plug from AC outlet if the product is not being used for a long period of time.

Don't:

- Block the slots and openings on the unit provided for ventilation.
- Use abrasive cleaners, waxes or solvents to clean the unit.
- Use under the following conditions:
  - In extremely hot, cold or humid environments.
  - In areas susceptible to excessive dust and dirt.
  - Near any appliance that generates a strong magnetic field.
  - Place In direct sunlight.

## Precautions

Follow all warnings, precautions and maintenance as recommended in this user's guide to maximize the life of your unit.



### Warning:

- Do not look into the projector's lens when the lamp is on. The bright light may hurt your eyes.
- To reduce the risk of fire or electric shock, do not expose this product to rain or moisture.
- Please do not open or disassemble the product as this may cause electric shock.
- When changing the lamp, please allow unit to cool down, and follow all changing instructions.
- This product will detect the life of the lamp itself. Please be sure to change the lamp when it shows warning messages.
- Reset the "Lamp Hour Reset" function from the Onscreen display "Management" menu after replacing the lamp module.
- When switching the projector off, please ensure the projector completes its cooling cycle before disconnecting power.
- Turn on the projector first and then the signal sources.
- Do not use lens cap when projector is in operation.
- When the lamp reaches the end of its life, it will burn out and may make a loud popping sound. If this happens, the projector will not turn back on until the lamp module has been replaced. To replace the lamp, follow the procedures listed under "Replacing the Lamp".



Information for your safety and comfort	iii
First things first	viii
Usage Notes	viii
Precautions	viii
Introduction	1
Product Features	1
Package Overview	2
Projector Overview	3
Projector Outlook	3
Control Panel	5
Remote Control Layout	6
MHL (Mobile High-Definition Link) Control	8
Getting Started	9
Connecting the Projector	9
Turning the Projector On/Off	11
Turning on the Projector	11
Turning the projector off	12
Adjusting the Projected Image	13
Adjusting the Height of Projected Image	13
How to optimize image size and distance	14
How to get a preferred image size by adjusting distance and zoom	16
How to get a preferred image position by adjusting lens shift	18
User Controls	20
Onscreen Display (OSD) Menus	20
Color	21
Image	23
Setting	26
Management	27
Audio	28
Acer LAN webpage management	29
How to login in	29

# Contents

Home	30
Control Panel	30
Network Setting	31
Alert Setting	31
Logout	32
<b>Appendices</b>	<b>33</b>
Troubleshooting	33
LED & Alarm Definition Listing	37
Replacing the Lamp	38
Ceiling Mount Installation	39
Specifications	42
Compatibility modes	45
<b>Regulations and safety notices</b>	<b>53</b>

# Introduction

## Product Features

This product is a single-chip DLP® projector. Outstanding features include:

- DLP® technology
- Native 3840x2160 resolution  
Full/4:3/16:9/L.Box/Anamorphic 2.35:1 aspect ratio supported
- High brightness and contrast ratio
- Versatile display modes (Bright, Standard, sRGB\*, Rec. 709\*, Movie, Dark Cinema, Game, Sports, Silent, ISF Night\*, ISF Day\*, User) enable optimum performance in any situation
- HDTV (480i/p, 576i/p, 720p, 1080i/p, 2160p) supported
- Lower power consumption and economy (ECO) mode extend lamp life
- Acer EcoProjecton Technology delivers Intelligent power management approach and physical efficiency improvement
- Equipped with HDMI™ & MHL connection supporting HDCP
- Smart detection delivers quick, intelligent source detection
- Multi-language onscreen display (OSD) menus
- Manual focus projection lens zooms up to 1.3x / 1.6x
- 1.25x digital zoom
- Microsoft® Windows® 2000, XP, Vista®, Windows 7, Windows 8.1, Windows 10, Macintosh® OS compliant, ChromeOS Compliant
- Support MHL V2.1 signal display
- Auto image re-sizing to 4K Addressable Pixels full screen
- Built-in Two 5 Watts speakers
- Manual lens vertical shift adjustment



.....  
**Note:** (\*) Functions vary depending on model definition.

## Package Overview

This projector comes with all the items shown below. Check to make sure your unit is complete. Contact your dealer immediately if any thing is missing.



Projector



Power cord

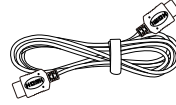

HDMI cable



User's guide (option)

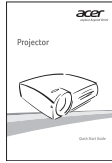

Quick start guide



Carrying case  
(option)



Remote control

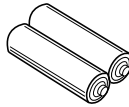

AAA battery x2  
(option)

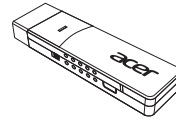

WirelessCAST  
(option)

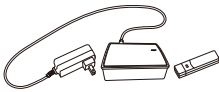

WirelessHD-Kit  
(option)



**Note:** When projecting a 4K2K/60Hz signal, use an HDMI Premium certified 4K2K/60Hz cable supporting 18Gbps bandwidth.



Trust the cable with the label

# Projector Overview

## Projector Outlook

Front / upper side

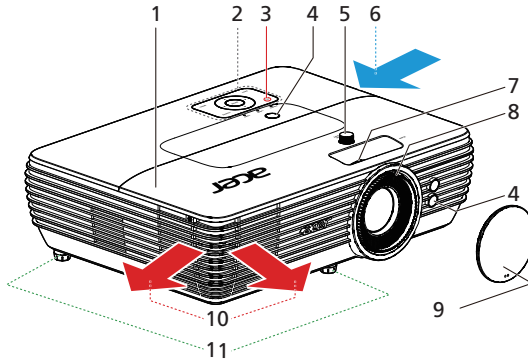

#	Description	#	Description
1	Lamp cover	7	Zoom ring
2	Control panel	8	Focus ring
3	Power button	9	Lens cap
4	Remote control receiver	10	Air outlet
5	Lens shift control ring	11	Tilt adjusting wheels
6	Air inlet		

## Right / Rear side

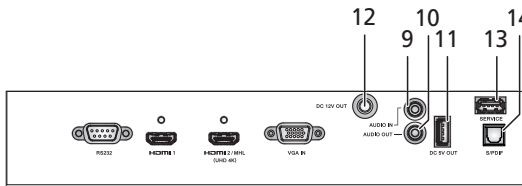
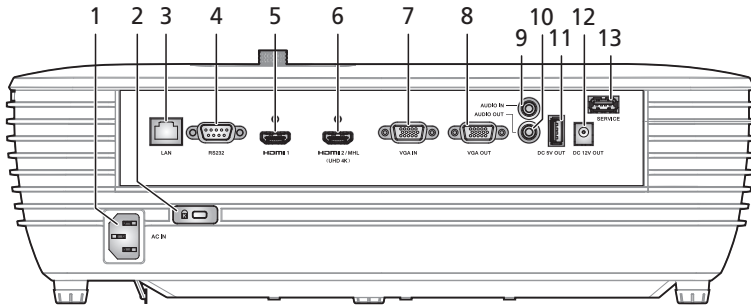

#	Description	#	Description
1	Power socket	8	Monitor loop-through output connector
2	Kensington™ lock port	9	Audio in connector
3	LAN (RJ45 Port for 10/100M Ethernet)	10	Audio out connector
4	RS232 connector	11	5V DC output connector
5	HDMI 1 connector	12	12V DC output connector
6	HDMI 2/MHL connector	13	Service connector (for firmware upgrade)
7	PC analog signal/HDTV/component video input connector	14	S/PDIF connector



**Note:** Functions vary depending on model definition.

## Control Panel

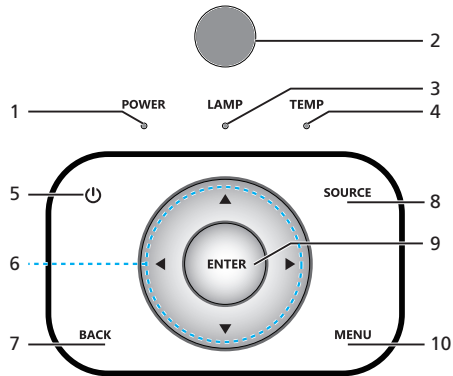

#	Icon	Function	Description
1	POWER	POWER	Power Indicator LED
2		IR Receiver	Remote control receiver.
3	LAMP	LAMP	Lamp Indicator LED
4	TEMP	TEMP	Temp Indicator LED
5		POWER	See the contents in " <b>Turning the Projector On/Off</b> " section.
6		Four directional select keys	Use ▲▼▶◀ to select items or make adjustments to your selection.
7	BACK	BACK	Returns to the previous operation.
8	SOURCE	SOURCE	Changes the active source.
9	ENTER	ENTER	Confirm your selection of items.
10	MENU	MENU	Press " <b>MENU</b> " to launch the Onscreen display (OSD) menu or exit the OSD menu.







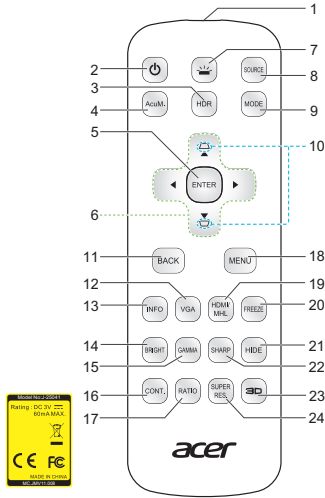











.....  
**Note:** Functions vary depending on model definition.

## Remote Control Layout



#	Icon	Function	Description
1		Infrared transmitter	Sends signals to the projector.
2		POWER	Refer to the " <b>Turning the Projector On/Off</b> " section.
3		HDR	Compatible with the latest HDR format, which delivers crisp, clear images with sharp changes in brightness, and provides realistic images with enhanced details, extended depth of field, and rich color gamut. HDR has 4 levels and each level suits different type of content, including dark and bright scene. <Note> If the HDR option is adjusted under the SDR (Standard Dynamic Range) signal, the screen is an abnormal color.
4		AcuMotion	Activate AcuMotion to provide a smoother image when viewing video content.
5		Select/Enter	Confirm your selection of items.
6		Four directional select keys	Use up, down, left, right buttons to select items or make adjustments to your selection.
7		Backlight	Remote backlight.
8		SOURCE	Changes the active source.



#	Icon	Function	Description
9		MODE	Press " <b>MODE</b> " to select the display mode from Bright, Standard, sRGB*, Rec. 709*, Movie, Dark Cinema, Game, Sports, Silent, ISF Night*, ISF Day*, User. <Note> (*) Functions vary depending on model definition.
10		KEystone	Adjusts the image to compensate for distortion caused by tilting the projector.
11		BACK	Returns to the previous operation.
12		VGA	Press " <b>VGA</b> " to change source to the VGA connector. This connector supports analog RGB, YPbPr (480p/576p/720p/1080i), YCbCr (480i/576i) and RGB sync.
13		Information	Display the projector information for Model Name, Input Source, Signal Type, Display Mode, Software Version and QR Code on the screen.
14		Brightness	Adjust the brightness of the image.
15		GAMMA	Effects the representation of dark scenery. With greater gamma value, dark scenery looks brighter.
16		Contrast	Adjusting the contrast changes the amount of black and white in the image.
17		Aspect Ratio	To choose the desired aspect ratio.
18		MENU	Press " <b>MENU</b> " to launch the Onscreen display (OSD) menu or exit the OSD menu.
19		HDMI™/MHL	To change source to HDMI/MHL.
20		FREEZE	To pause the screen image.
21		HIDE	Momentarily turns off the video. Press " <b>HIDE</b> " to hide the image, press again to display the image.
22		Sharpness	Adjusts the sharpness of the image.
23		3D	Press "3D" to select 3D models.
24		Super Resolution	Adjust the edges of the projected image in order to provide more perceived details.



**Note:** Functions vary depending on model definition.

## MHL (Mobile High-Definition Link) Control

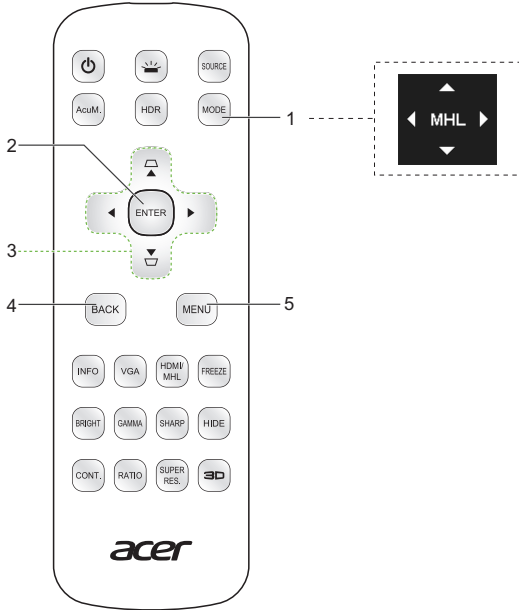

#	Icon	Function	Description
1		MODE	<ul style="list-style-type: none"> <li>Press "MODE" button for one second to activate the MHL Control Mode.</li> <li>To exit, press the "MODE" button again.</li> </ul>
2		Select/Enter	Press to select/enter the file.
3		Four directional select keys	Use up, down, left, right buttons to select items or make adjustments to your selection.
4		Back/Exit	<ul style="list-style-type: none"> <li>Press "BACK" to go back one menu step.</li> <li>To exit the file.</li> </ul>
5		MENU	Press to launch the root menu.



**Note:** Functions vary depending on model definition.

# Getting Started

## Connecting the Projector

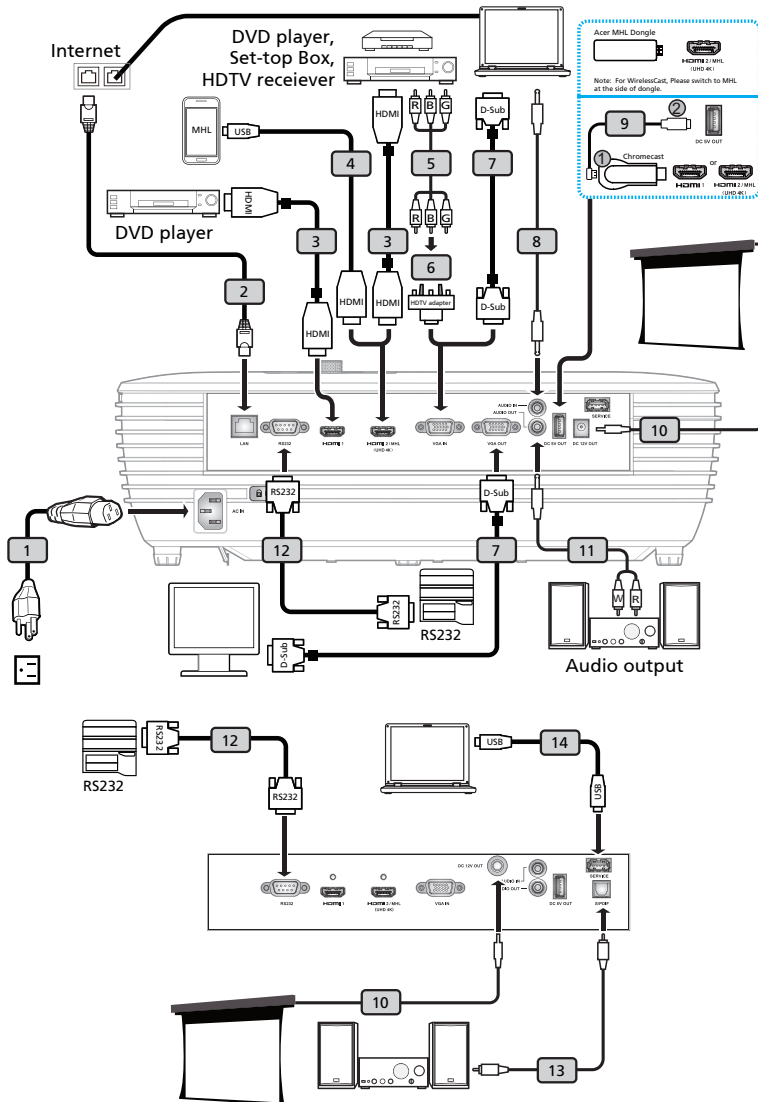

#	Description	#	Description
1	Power cord	8	Audio cable Jack/Jack
2	LAN cable	9	USB cable for charging device
3	HDMI cable	10	12V DC cable
4	MHL cable (MicroUSB to HDMI)	11	Audio cable Jack/RCA
5	3 RCA component cable	12	RS232 cable
6	VGA to component/HDTV adapter	13	S/PDIF cable
7	VGA cable	14	USB cable



.....

**Note 1:** To ensure the projector works well with your computer, please make sure the timing of the display mode is compatible with the projector.

**Note 2:** Functions vary depending on model definition.

**Note 3:** USB cable needs powered extender if the length is over 5 m.

**Note 4:** Some smartphones require a converter (supplied by smartphone maker) to enable the MHL function.

**Note 5:** USB DC 5V out connector support 5V/1.5A power output for HDMI dongle charging only when MHL source is not detected.

**Note 6:** DC 12V out connector support 12V/100mA power for screen control only.

# Turning the Projector On/Off

## Turning on the Projector

- 1 Ensure that the power cord and signal cable are securely connected. The Power indicator LED will flash red.
- 2 Turn on the projector by pressing "**Power**" button on the control panel or remote control, and the Power indicator LED will turn blue.
- 3 Turn on your source (computer, notebook, video player ,etc.). The projector will detect your source automatically.
  - If the screen displays "Lock" and "Source" icons, it means the projector is locked onto a specific source type and there is no such type of input signal detected.
  - If the screen displays "No Signal", please make sure the signal cables are securely connected or press source direct key.
  - If you connect to multiple sources at the same time, use the "Source" button on either control panel or the remote control or direct source key on the remote control to switch between inputs.

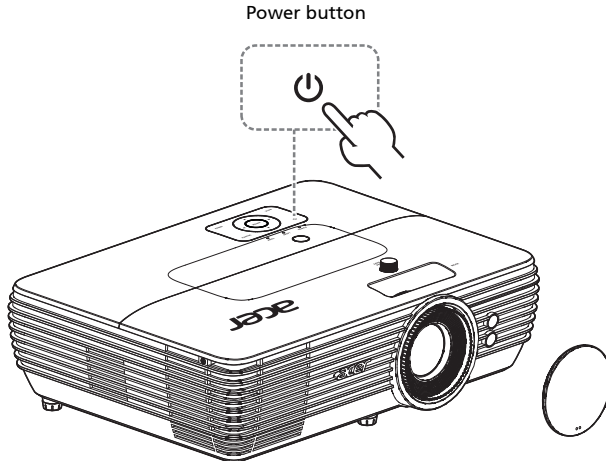

## Turning the projector off

- 1 To turn the projector off, press and hold the power button. This message appears: **"Please press the power button again to complete the shutdown process."** Press the power button again.
- 2 The LED power indicator will turn RED and blink rapidly after the projector is turned off, and the fan(s) will continue to operate for about 10 seconds to ensure that the system cools properly.
- 3 Once the system has finished cooling, the LED power indicator will stop blinking and turn solid red to indicate standby mode.
- 4 It is now safe to unplug the power cord.



### Warning indicators:

- **"Projector Overheated. Lamp will automatically turn off soon."**  
This onscreen message indicates that the projector has overheated. The lamp will automatically turn off, the projector will automatically shut down, and the LED temp indicator will turn solid red. Contact your local dealer or service center.
- **"Fan failed. Lamp will automatically turn off soon."**  
This onscreen message indicates that the fan has failed. The lamp will automatically turn off, the projector will automatically shut down, and the LED temp indicator will blink. Contact your local dealer or service center.



**Note 1:** Whenever the projector automatically shuts down and the LED lamp indicator turns solid red, contact your local reseller or service center.

**Note 2:** Functions vary depending on model definition.

**Attention!** The projector will enter a two minute cool down period to ensure continued optimal lamp operation.

**Attention!** Please do not turn off projector within 1 minute after power on.

## Adjusting the Projected Image

### Adjusting the Height of Projected Image

The projector is equipped with elevator feet for adjusting the height of image.

To raise/lower the image:

Use Tilt adjusting wheel to fine-tune the display angle.

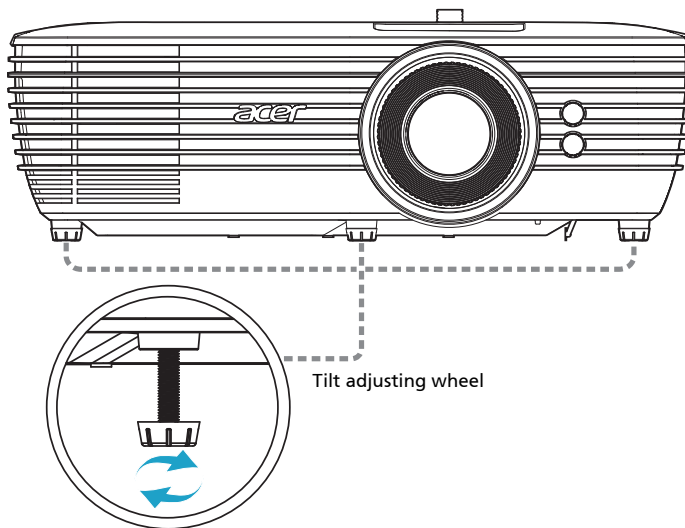

## How to optimize image size and distance

Consult the table below to find the optimal image sizes achievable when the projector is positioned at a desired distance from the screen.

- H7850/V7850/E270/V270/HE-4K20/HT-4K20/M550/V550/D4K1701/D4K1702 series

If the projector is 2.0 m from the screen, good image quality is possible for image sizes between 41" and 65".



**Note:** Remind as below figure, the space of 81 cm height is required when located at 2 m distance.

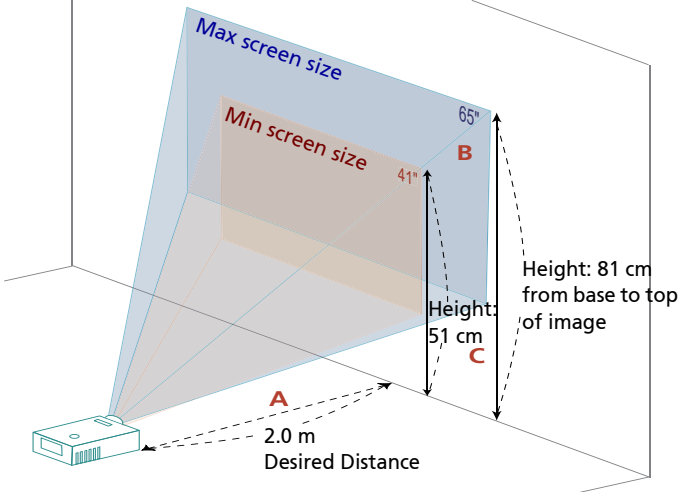

Desired Distance (m) <A>	Screen size			Screen size		
	(Min zoom)			(Max zoom)		
	Diagonal (inch) <B>	W (cm) x H (cm)	From base to top of image (cm) <C>	Diagonal (inch) <B>	W (cm) x H (cm)	From base to top of image (cm) <C>
1.0	20.00	45 x 25	25	33	72 x 40	40
1.3	26	59 x 33	33	42	94 x 53	53
2.0	41	90 x 51	51	65	144 x 81	81
2.5	51	113 x 63	63	81	181 x 101	101
3.0	61	135 x 76	76	97	216 x 121	121
3.5	71	158 x 89	89	114	252 x 142	142
4.0	81	180 x 101	101	130	288 x 162	162
5.0	102	225 x 127	127	162	360 x 202	202
6.0	122	270 x 152	152	195	432 x 243	243
7.0	142	315 x 177	177	227	504 x 283	283
8.0	163	360 x 203	203	260	576 x 324	324
9.0	183	405 x 228	228	292	647 x 364	364
9.3	189	419 x 236	236	302	669 x 376	376

Zoom Ratio: 1.6x



- H6815/V6815/E8615/E8615C/ET-4K15/HT-4K15/GM834/HV834/VH-735/  
TH-735/D4K1735/D4K1732 series

If the projector is 2 m from the screen, good image quality is possible for image sizes between 57" and 75".



**Note:** Remind as below figure, the space of 98 cm height is required when located at 2 m distance.

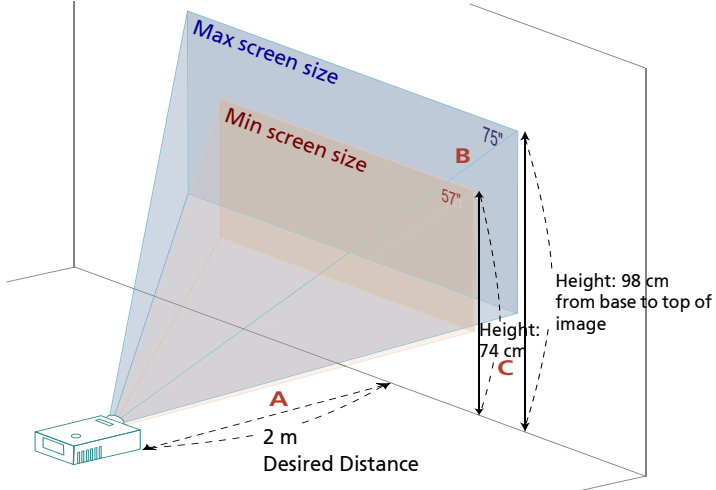

Desired Distance (m) <A>	Screen size		Top	Screen size		Top
	(Min zoom)			(Max zoom)		
	Diagonal (inch) <B>	W (cm) x H (cm)	From base to top of image (cm) <C>	Diagonal (inch) <B>	W (cm) x H (cm)	From base to top of image (cm) <C>
1	28	63 x 35	37	37	83 x 46	49
2	57	126 x 71	74	75	165 x 93	98
2.5	71	157 x 88	93	93	207 x 116	122
3	85	189 x 106	111	112	248 x 139	146
3.5	99	220 x 124	130	131	289 x 163	171
4	114	252 x 142	149	149	331 x 186	195
5	142	314 x 177	186	187	413 x 232	244
6	170	377 x 212	223	224	496 x 279	293
7	199	440 x 248	260	261	579 x 325	342
8.04	228	506 x 284	299	300	664 x 374	392

Zoom Ratio: 1.3x

## How to get a preferred image size by adjusting distance and zoom

The table below shows how to achieve a desired image size by adjusting either the position or the zoom ring.

- H7850/V7850/E270/V270/HE-4K20/HT-4K20/M550/V550/D4K1701/D4K1702 series

To obtain an image size of 60" set the projector at a distance 1.8 m and 2.9 m from the screen.

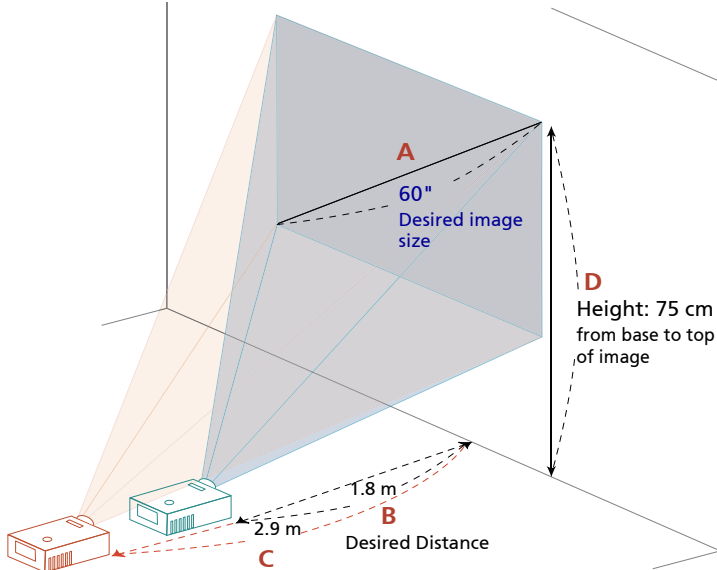

Desired Image Size		Distance (m)		Top (cm)
Diagonal (inch) <A>	W (cm) x H (cm)	Max zoom <B>	Min zoom <C>	From base to top of image <D>
20	44 x 25		1.0	25
26.45	59 x 33	0.8	1.3	33
60	133 x 75	1.8	2.9	75
70	155 x 87	2.2	3.4	87
80	177 x 100	2.5	3.9	100
90	199 x 112	2.8	4.4	112
100	221 x 125	3.1	4.9	125
120	266 x 149	3.7	5.9	149
150	332 x 187	4.6	7.4	187
200	443 x 249	6.2	9.8	249
250	553 x 311	7.7	12.3	311
300	664 x 374	9.2	14.7	374
303.2	671 x 378	9.3		378

Zoom Ratio: 1.6x

- H6815/V6815/E8615/E8615C/ET-4K15/HT-4K15/GM834/HV834/VH-735/TH-735/D4K1735/D4K1732 series

To obtain an image size of 60" set the projector at a distance 1.6 m and 2.1 m from the screen.

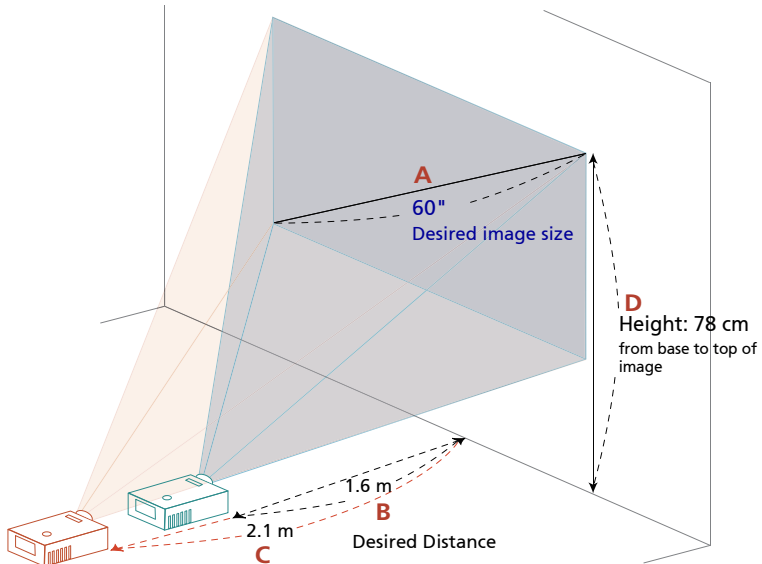

Desired Image Size		Distance (m)		Top (cm)
Diagonal (inch) <A>	W (cm) x H (cm)	Max zoom <B>	Min zoom <C>	From base to top of image <D>
37.5	83 x 47	1.0	1.3	49
40	89 x 50	1.1	1.4	52
50	111 x 62	1.3	1.8	65
60	133 x 75	1.6	2.1	78
70	155 x 87	1.9	2.5	92
80	177 x 100	2.1	2.8	105
90	199 x 112	2.4	3.2	118
100	221 x 125	2.7	3.5	131
120	266 x 149	3.2	4.2	157
150	332 x 187	4.0	5.3	196
200	443 x 249	5.4	7.0	262
250	553 x 311	6.7	8.8	327
300	664 x 374	8.04	10.6	392

Zoom Ratio: 1.3x

## How to get a preferred image position by adjusting lens shift

The projector is equipped with lens shift for adjusting the position of projected image up and down without requiring you to physically move the projector.

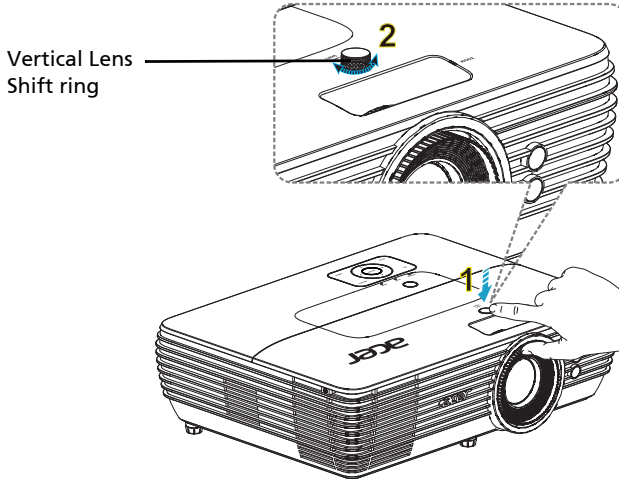

**Note:** The figures shown in this section are for reference only not approximate value. The figures between units can be different due to assembly tolerance.

H7850/V7850/E270/V270/HE-4K20/HT-4K20/M550/V550/D4K1701/D4K1702 series:

The vertical height can be adjusted between 0% and 15% of the image height. (The typical vertical image offset is fixed at 15% of the image height above the center of the projector lens.)

H6815/V6815/E8615/E8615C/ET-4K15/HT-4K15/GM834/HV834/VH-735/TH-735/D4K1735/D4K1732 series:

The vertical height can be adjusted between 0% and 10% of the image height. (The typical vertical image offset is fixed at 10% of the image height above the center of the projector lens.)

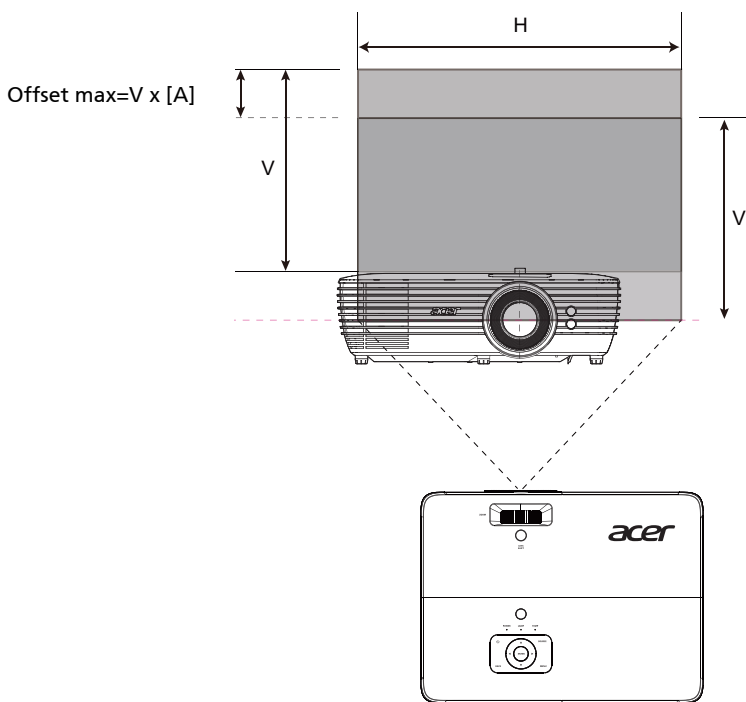







Offset	H7850/V7850/E270/V270/HE-4K20/ HT-4K20/M550/V550/D4K1701/D4K1702	H6815/V6815/E8615/E8615C/ ET-4K15/HT-4K15/ GM834/HV834/VH-735/TH-735/ D4K1735/D4K1732
	max [A]	max [A]
V	15%	10%

# User Controls

## Onscreen Display (OSD) Menus

The projector has multilingual OSD that allow you to make image adjustments and change a variety of settings.

### Using the OSD menus

- To open the OSD menu, press **"MENU"** on the remote control or control panel.
- When the OSD is displayed, use the   keys to select any item in the main menu. After selecting the desired main menu item, press **"ENTER"** to enter submenu for feature setting.
- Use the   keys to select the desired item and adjust the settings by using the   keys.
- Select the next item to be adjusted in the submenu and adjust as described above.
- Press **"BACK"** on the remote control or control panel, the screen will return to the main menu.
- To exit OSD, press **"BACK"** on the remote control or control panel. The OSD menu will close and the projector will automatically save the new settings.

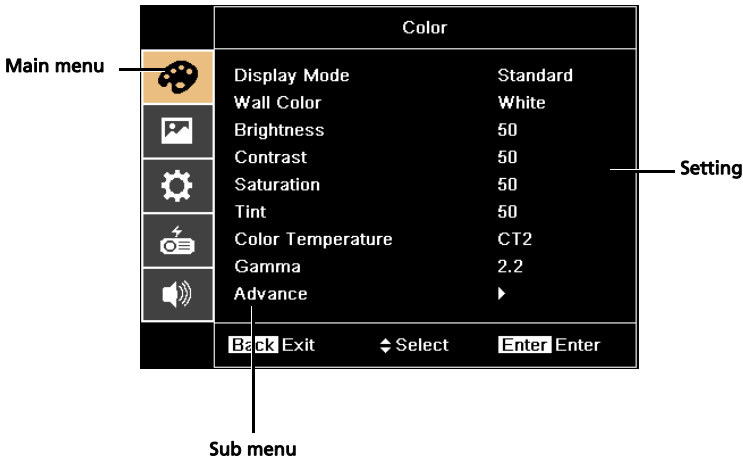

**Note 1:** Some of the following OSD settings may not be available. Please refer to the actual OSD of your projector.

**Note 2:** Functions vary depending on model definition.

## Color

Display Mode	<p>There are many factory presets optimized for various types of images.</p> <ul style="list-style-type: none"> <li>• Bright: For brightness optimization.</li> <li>• Standard: For common environment.</li> <li>• sRGB: standard RGB color space.</li> <li>• Movie: For brighter and general movie/video/photo playing.</li> <li>• Dark Cinema: For dark movie content.</li> <li>• Game: For game content.</li> <li>• Sports: For sport picture.</li> <li>• Silent: For silent environment.</li> <li>• Rec. 709: standard Rec. 709 color space.</li> <li>• ISF Day: Calibrate and optimize the projection image based on bright environment by an ISF Certified technician.</li> <li>• ISF Night: Calibrate and optimize the projection image based on dark environment by an ISF Certified technician.</li> <li>• User: Memorize user's settings.</li> </ul>
Wall color	<p>Use this function to choose a proper color according to the wall. There are several choices, including white, light yellow, light blue, pink, dark green. It will compensate the color deviation due to the wall color to show the correct image tone.</p>
Brightness	<p>Adjust the brightness of the image.</p> <ul style="list-style-type: none"> <li>• Press ◀ to darken the image.</li> <li>• Press ▶ to lighten the image.</li> </ul>
Contrast	<p>"Contrast" controls the difference between the lightest and darkest parts of the picture. Adjusting the contrast changes the amount of black and white in the image.</p> <ul style="list-style-type: none"> <li>• Press ◀ to decrease the contrast.</li> <li>• Press ▶ to increase the contrast.</li> </ul>
Saturation	<p>Adjusts a video image from black and white to fully saturated color.</p> <ul style="list-style-type: none"> <li>• Press ◀ to decrease the amount of color in the image.</li> <li>• Press ▶ to increase the amount of color in the image.</li> </ul>
Tint	<p>Adjusts the color balance of red and green.</p> <ul style="list-style-type: none"> <li>• Press ◀ to increase the amount of green in the image.</li> <li>• Press ▶ to increase the amount of red in the image.</li> </ul>
Color Temperature	<p>Use this function to choose CT1, CT2, CT3.</p>
Gamma	<p>Effects the representation of dark scenery. With greater gamma value, dark scenery looks brighter.</p>

Advanced	<p>RGB Gain/Bias Adjusts the red gain/green gain/blue gain/red bias/green bias/blue bias for color optimization.</p>
	<p>AcuEngine: Adjust the AcuEngine parameters.</p> <ul style="list-style-type: none"> <li>• AcuColor: Use to significantly increase the image's vividness.</li> <li>• AcuMotion: Activate AcuMotion to provide a smoother image when viewing video content.</li> <li>• AcuMotion Demo: This feature enables you to see the difference in the image quality between the raw unprocessed image and the image processed as processed by the AcuMotion. Use this mode to check the adjustments that you make to the AcuMotion settings.</li> </ul>
	<p>Dynamic Black Choose "On" to automatically optimize the display of dark movie scenes enabling them to be shown in incredible detail.</p>
	<p>HDR Compatible with the latest HDR format, which delivers crisp, clear images with sharp changes in brightness, and provides realistic images with enhanced details, extended depth of field, and rich color gamut. HDR has 4 levels and each level suits different type of content, including dark and bright scene. &lt;Note&gt; If the HDR option is adjusted under the SDR (Standard Dynamic Range) signal, the screen is an abnormal color.</p>
	<p>ISF 1. The certified ISF technician will calibrate and optimize the projection image according to your actual environment. The ISF input password will be kept by technician only. 2. "ISF Day" and "ISF Night" will not be shown in display mode if projector equipped with ISF function has not been calibrated by an ISF certified technician. For more information, please go to ISF official website: <a href="https://www.imagingscience.com">https://www.imagingscience.com</a> and contact the dealer located in your country. 3. The ISF calibration will be charged and guaranteed by ISF certified calibrator, and thereby Acer is not responsible for the calibration service.</p>
<p>Reset Reset one or all settings under the Display Mode menu which include Brightness, Contrast, Saturation, Tint, Color Temperature, Gamma, RGB Gain / Bias, AcuEngine, and Sharpness.</p>	













**Note 1:** "Saturation" and "Tint" functions are not supported under computer or HDMI mode.

**Note 2:** Functions vary depending on model definition.



# Image

Projection	<ul style="list-style-type: none"> <li>•  <b>Front:</b> The factory default setting.</li> <li>•  <b>Rear:</b> When you select this function, the projector reverses the image so you can project from behind a translucent screen.</li> <li>•  <b>Rear Ceiling:</b> When you select this function, the projector reverses and inverts the image at same time. You can project from behind a translucent screen with ceiling mounted projection.</li> <li>•  <b>Ceiling:</b> When you select this function, the projector inverts the image for ceiling-mounted projection.</li> </ul>
Aspect Ratio	<p>Use this function to choose your desired aspect ratio.</p> <ul style="list-style-type: none"> <li>• <b>Auto:</b> Keep the image with original width-highth ratio and maxi mize the image to fit native horizontal or vertical pixels.</li> <li>• <b>Full:</b> Resize image to fit full screen by width (3840 pixels) and height (2160 pixels).</li> <li>• <b>4:3:</b> The image will be scaled to fit the screen and displayed using a 4:3 ratio.</li> <li>• <b>16:9:</b> The image will be scaled to fit the width of the screen and the height adjusted to display the image using a 16:9 ratio.</li> <li>• <b>L.Box:</b> Keep original signal aspect ratio and zoom in by 1.333 times.</li> <li>• <b>Anamorphic 2.35:1:</b> Stretches the image vertically to fit anamorphic lens. Keeps the image with original width ratio and resizes the its height to 1.321875 ties of the original image.</li> </ul>
Sharpness	<p>Adjusts the sharpness of the image.</p> <ul style="list-style-type: none"> <li>• Press  to decrease the sharpness.</li> <li>• Press  to increase the sharpness.</li> </ul>
Keystone	<p>Adjust image distortion caused by tilting projection.</p> 
Super Resolution	<p>Adjust the edges of the projected image in order to provide more perceived details.</p>

Signal	H. Position (Horizontal position) <ul style="list-style-type: none"> <li>Press  to move the image left.</li> <li>Press  to to move the image right.</li> </ul>
	V. Position (Vertical position) <ul style="list-style-type: none"> <li>Press  to move the image left.</li> <li>Press  to to move the image right.</li> </ul>
	Frequency "Frequency" changes the projector's refresh rate to match the frequency of your computer's graphics card. If you can see a vertical flickering bar in the projected image, use this function to make the necessary adjustments.
	Tracking Synchronizes the signal timing of the projector with the graphics card. If you experience an unstable or flickering image, use this function to correct it.
HDMI	HDMI Color Range Adjust the color range of the HDMI image data to correct color display error. <ul style="list-style-type: none"> <li>Auto: Automatically adjust by information from player.</li> <li>Limited Range: Process the input image as limited color range data.</li> <li>Full Range: Process the input image as full color range data.</li> </ul>
	HDMI Scan Info Adjust the overscan ratio of the HDMI image on screen. <ul style="list-style-type: none"> <li>Auto: Automatically adjust by information from player.</li> <li>Underscan: Always no overscan on HDMI image.</li> <li>Overscan: Always keep overscan on HDMI image.</li> </ul>
3D	3D Choose "On" to enable DLP 3D function. <ul style="list-style-type: none"> <li>On: Choose this item while using DLP 3D glasses, 120Hz 3D capable graphics cards with corresponding SW player.</li> <li>Off: Turn off 3D mode.</li> </ul>
	3D L/R Invert If you see a discrete or overlapping image while wearing DLP 3D glasses, you may need to execute "Invert" to get best match of left/right image sequence to get the correct image (for DLP 3D).



**Note 1:** "H. Position", "V. Position", "Frequency" and "Tracking" functions are not supported under HDMI or Video mode.

**Note 2:** "HDMI Color Range" and "HDMI Scan Info" functions are only supported under HDMI mode.

**Note 3:** Functions vary depending on model definition.

**Note 4:** It needs correct settings on graphic card 3D application program for correct 3D display.

**Note 5:** The SW players, such as Stereoscopic Player and DDD TriDef Media Player can support 3D format files. You can download these three players on web page below,

- Stereoscopic Player (Trial):

[http://www.3dtv.at/Downloads/Index\\_en.aspx](http://www.3dtv.at/Downloads/Index_en.aspx)

- DDD TriDef Media Player (Trial):

<http://www.tridef.com/download/TriDef-3-D-Experience-4.0.2.html>

**Note 6:** "3D L/R Invert" is only available when 3D is enabled.

**Note 7:** There has reminder screen if 3D still enable when power on projector.  
Please adjust setting depended on your purpose.



## Setting

Source Selection	Manual by source menu, Auto by Smart Detection.
Auto Screen	Default is "On" , the down/up move of electronic screen will be related with power on/off of Projector.
DC 5V Out	Default is "On". Choose "Off" to Disable DC 5V OUT connection. <Note> 5V/1.5A power output if MHL source is not detected. Warning!The DC 5V Out may happen power conflict if connecting to PC and result in electric shock and/or injury.
VGA OUT (Standby)	Default is "Off". Choose "On" to enable VGA OUT connection.
Test Pattern	Default is "Off" to disable this function. Choose "On" to enable test pattern for installation.
LAN	LAN Standby Default is "Off". Choose "On" to enable LAN control under standby mode.
	LAN IP Identify IP address.
	LAN Mask Identify Mask address.
	LAN Reset Reset LAN function.
Information	Display the projector information for Model Name, Input Source, Signal Type, Display Mode, Software Version and QR code on the screen.
	Scan QR code linking to Acer projector portal via mobile. 
Reset	Press the "ENTER" button and choose "Yes" to return the parameters on all menus to the factory default settings.



**Note:** Functions vary depending on model definition.



## Management

ECO Mode	Choose "On" to dim the projector lamp which will lower power consumption, extend the lamp life and reduce noise. Choose "Off" to return normal mode.
High Altitude	Choose "On" to turn on High Altitude mode. Operate the fans at full speed continuously to allow for proper high altitude cooling of the projector.
Auto Shutdown	The projector will automatically shutdown when there is no signal input after the allocated time. (default is 15 minutes)
Menu Display Time (Seconds)	Choose the OSD menu display time. (Default is 15 seconds). Select "Manual" to turn off main menu/one direct-key menu manually by user.
AC Power On	Choose "On" to power on projector while AC power plug in.
Lamp	Lamp Hour Elapse Displays the lamp's elapsed operating time (in hours).
	Lamp Reminding Activate this function to display a reminder to change the lamp 30 hours before its expected end-of-life.
	Lamp Hour Reset Choose "Yes" and press "ENTER" to turn the lamp hour counter to 0 hours.
Language	Choose the multilingual OSD menu. Use the   key to select your preferred menu language. • Press "ENTER" to confirm the selection.



**Note:** Functions vary depending on model definition.

## Audio

Volume	<ul style="list-style-type: none"><li>• Press  to decrease the volume.</li><li>• Press  to increase the volume.</li></ul>
Mute	<ul style="list-style-type: none"><li>• Choose "On" to mute the volume.</li><li>• Choose "Off" to restore the volume.</li></ul>



.....

**Note:** Functions vary depending on model definition.

# Acer LAN webpage management

## How to login in

Open browser and enter the Server IP address by 192.168.100.10 to find below homepage of acer LAN webpage management. A password is needed to login in before using.

Select a user. **Administrator** is with high authority that can process more operations such as network setting and alert setting. Default password of administrator is "admin". And **User** is with normal authority with default password by "user". Click Login button to enter into homepage with correct password.

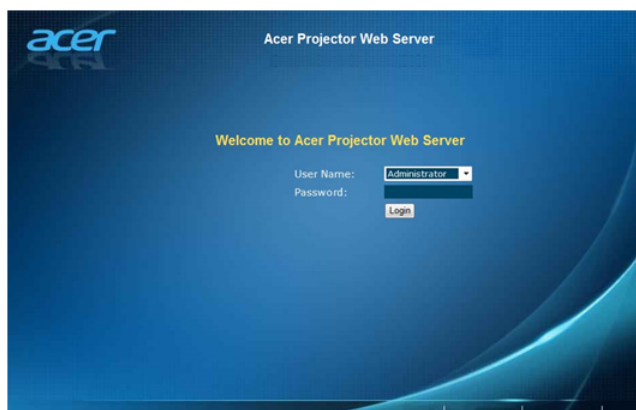

# Home

Home page shows connection status and you can find three main functions listed, **Control Panel**, **Network Setting** and **Alert Setting**.

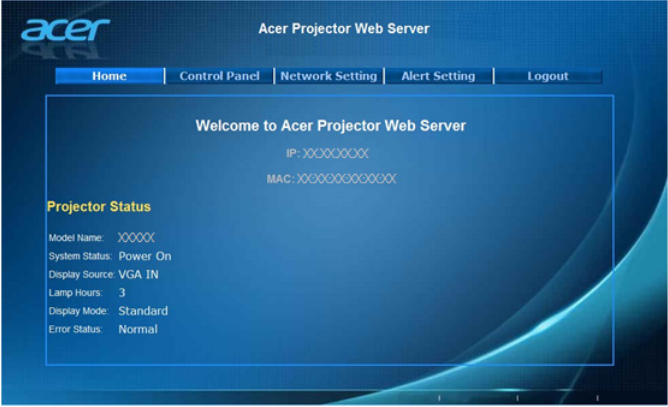

**Note:** Alert Setting and Network Setting are only for Administrator account.

# Control Panel

Enduser can control and adjust projector setting value via this page.





## Network Setting

Enduser can set IP address and password as wish. After change network configurations or password, projector will reboot automatically after press "Apply".

## Alert Setting

Enduser can send mail with error message right away if projector has problem.

## Logout

After tap Logout, you will return to login page within 5 seconds.

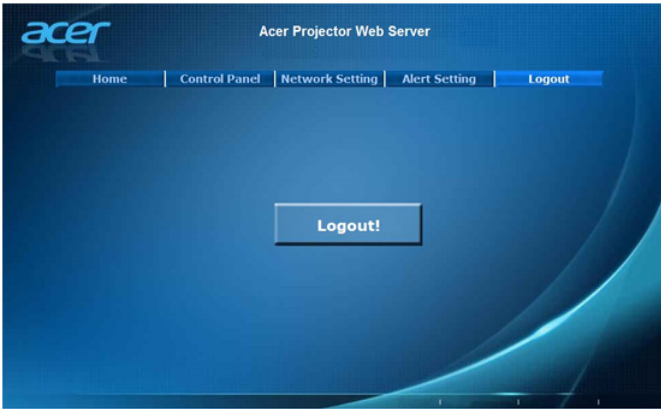

.....  
**Note:** Functions vary depending on model definition.

# Appendices

## Troubleshooting

If you experience a problem with your Acer projector, refer to the following troubleshooting guide. If the problem persists, please contact your local reseller or service center.

### Image Problems and Solutions

#	Problem	Solution
1	No image appears onscreen	<ul style="list-style-type: none"> <li>• Connected as described in the "Getting Started" section.</li> <li>• Ensure none of the connector pins are bent or broken.</li> <li>• Check if the projector lamp has been securely installed. Please refer to the "Replacing the Lamp" section.</li> <li>• Make sure you have removed the lens cap and the projector is switched on.</li> </ul>
2	Partial, scrolling or incorrectly displayed image (for PC (Microsoft® Windows® 2000, XP, Vista®, Windows 7, Windows 8.1, Windows 10, Macintosh® OS compliant, ChromeOS Compliant))	<ul style="list-style-type: none"> <li>• For an incorrectly displayed image:             <ul style="list-style-type: none"> <li>• Open "My Computer", open the "Control Panel", and then double-click the "Display" icon.</li> <li>• Select the "Settings" tab.</li> <li>• Verify that your display resolution setting is lower than or equal to WUXGA-RB (1920 x 1200).</li> <li>• Click the "Advanced Properties" button.</li> </ul> </li> <li>• If the problem still appears, change the monitor display you are using and follow the steps below:             <ul style="list-style-type: none"> <li>• Verify that the resolution setting is lower than or equal to WUXGA-RB (1920 x 1200).</li> <li>• Click the "Change" button under the "Monitor" tab.</li> <li>• Click "Show all devices". Next, select "Standard monitor types" under the SP box, and choose the resolution mode you need under the "Models" box.</li> <li>• Verify that the resolution setting of the monitor display is lower than or equal to WUXGA-RB (1920 x 1200).</li> </ul> </li> </ul>

3	Partial, scrolling or incorrectly displayed image (For notebooks)	<ul style="list-style-type: none"> <li>• For an incorrectly displayed image:             <ul style="list-style-type: none"> <li>• Follow the steps for item 2 (above) to adjust the resolution of your computer.</li> <li>• Press the toggle output settings. Example: [Fn]+[F4], Compaq [Fn]+[F4], Dell [Fn]+[F8], Gateway [Fn]+[F4], IBM [Fn]+[F7], HP [Fn]+[F4], NEC [Fn]+[F3], Toshiba [Fn]+[F5]</li> </ul> </li> <li>• If you experience difficulty changing resolutions or your monitor freezes, restart all equipment including the projector.</li> </ul>
4	The screen of the notebook computer is not displaying your presentation	<ul style="list-style-type: none"> <li>• If you are using a Microsoft® Windows® based notebook: Some notebook PCs may deactivate their own screens when a second display device is in use. Each has a different way to be reactivated. Refer to your computer's manual for detailed information.</li> <li>• If you are using an Apple® Mac® OS based notebook: In System Preferences, open Display and select Video Mirroring "On".</li> </ul>
5	Image is unstable or flickering	<ul style="list-style-type: none"> <li>• Adjust the "Tracking" to correct it. Refer to the "Image" section for more information.</li> <li>• Change the display color depth settings on your computer.</li> </ul>
6	Image has vertical flickering bar	<ul style="list-style-type: none"> <li>• Use "Frequency" to make an adjustment. Refer to the "Image" section for more information.</li> <li>• Check and reconfigure the display mode of your graphics card to make it compatible with the projector.</li> </ul>
7	Image is out of focus	<ul style="list-style-type: none"> <li>• Make sure the lens cap is removed.</li> <li>• Adjusts the focus ring on the projector lens.</li> <li>• Make sure the projection screen is within the required distance of 3.3 to 30.3 feet (1.0 to 9.2 meters) (H7850/V7850/E270/V270/HE-4K20/HT-4K20/M550/V550/D4K1701/D4K1702 series) / 3.3 to 26.4 feet (1.0 to 8.0 meters) (H6815/V6815/E8615/E8615C/ET-4K15/HT-4K15/GM834/HV834/VH-735/TH-735/D4K1735/D4K1732 series) from the projector. Refer to the "How to get a preferred image size by adjusting distance and zoom" section for more information.</li> </ul>

8	Image is stretched when displaying a "widescreen" DVD title	<p>When you play a DVD encoded in anamorphic or 16:9 aspect ratio you may need to adjust the following settings:</p> <ul style="list-style-type: none"> <li>• If you play a 4:3 format DVD title, please change the format to 4:3 in the projector OSD.</li> <li>• If the image is still stretched, you will also need to adjust the aspect ratio. Set up the display format to 16:9 (wide) aspect ratio on your DVD player.</li> <li>• If you play an Letterbox (LBX) format DVD title, please change the format to Letterbox (LBX) in the projector OSD.</li> </ul>
9	Image is too small or too large	<ul style="list-style-type: none"> <li>• Adjust the zoom ring on the projector.</li> <li>• Move the projector closer to or further from the screen.</li> <li>• Press "MENU" on the remote control. Go to "Image -&gt; Aspect Ratio" and try different settings or press "RATIO" on the remote control to adjust directly.</li> </ul>
10	Image has slanted sides	<ul style="list-style-type: none"> <li>• If possible, reposition the projector so that it is centered on the screen.</li> </ul>
11	Image is reversed	<ul style="list-style-type: none"> <li>• Select "Image --&gt; Projection" on the OSD and adjust the projection direction.</li> </ul>

OSD Messages

#	Condition	Message Reminder
1	Message	<ul style="list-style-type: none"> <li>Fan Fail - the system fan is not working.  <div style="background-color: black; color: white; padding: 5px; text-align: center;"> <b>Fan Fail.</b>                      Lamp will automatically turn off soon.                 </div> </li> <li>Projector Overheated - the projector has exceeded its recommended operating temperature and must be allowed to cool down before it may be used. Please check the following message.  <div style="background-color: black; color: white; padding: 5px;">                     Projector overheated, system will turn off automatically soon, please:                      1. Check if operation ambient temperature between 5 degree and 40 degree.                      2. Check if filter needs to be cleaned.                      3. Check if inlet or outlet is blocked.                      4. Check if high altitude mode is set when the projector operating at high altitude area.                 </div> </li> <li>Replace the lamp - the lamp is about to reach its maximum lifetime. Prepare to replace it soon.  <div style="background-color: black; color: white; padding: 5px; text-align: center;">                     Lamp is approaching the end of its useful life in full power operation.                      Replacement suggested!                 </div> </li> </ul>

Problems with the Projector

#	Condition	Solution
1	The projector stops responding to all controls	If possible, turn off the projector, then unplug the power cord and wait at least 30 seconds before reconnecting power.
2	Lamp burns out or makes a popping sound	When the lamp reaches the end of its useful life, it will burn out and may make a loud popping sound. If this happens, the projector will not turn on until the lamp module has been replaced. To replace the lamp, follow the procedures in the "Replacing the Lamp" section.

# LED & Alarm Definition Listing

## LED Messages

Message	Lamp_LED	Temp_LED	Power LED	
	Red	Red	Red	Blue
Input power plug	Flash ON to OFF 100ms	Flash ON to OFF 100ms	Flash ON to OFF 100ms	--
Standby	--	--	ON	--
Power button ON	--	--	--	ON
Lamp retry	--	--	--	Quick Flashing
Power off (Cooling state)	--	--	Quick Flashing	--
Power button OFF (cooling completed; standby mode)	--	--	ON	--
Error (thermal failure)	--	ON	--	ON
Error (fan lock)	--	Quick Flashing	--	ON
Error (lamp breakdown)	ON	--	--	ON
Error (color wheel fail)	Quick Flashing	--	--	ON

## Replacing the Lamp

Use a screwdriver to remove the screw(s) from the cover, and then pull out the lamp.

The projector will detect the lamp life. You will be shown a warning message "**Lamp is approaching the end of its useful life in full power operation. Replacement suggested!**" When you see this message, change the lamp as soon as possible. Make sure the projector has been cooling down for at least 30 minutes before changing the lamp.



**Warning:** The lamp compartment is hot! Allow it to cool down before changing the lamp.

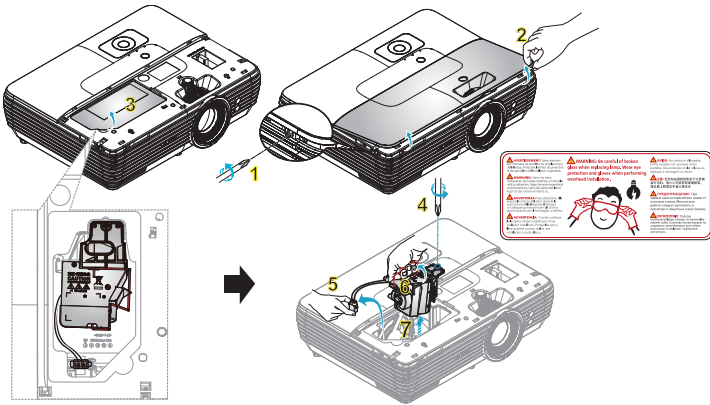

### To Change the Lamp

Turn off the projector by pressing the Power button.

Allow the projector at least 30 minutes to cool down.

Disconnect the power cord.

- 1 Use a screwdriver to remove the screw from the cover. (Illustration #1)  
Push to the direction of the arrow and push up the cover.. (Illustration #2)  
Remove the protector. (Illustration #3)
- 2 Remove the screw that secure the lamp module. (Illustration #4)  
Pull out the lamp plug. (Illustration #5)  
Lift the handle so that it stands up. (Illustration #6)
- 3 Pull out the lamp module by force. (Illustration #7)

To replace the lamp module, use a new lamp and reverse the above steps.



**Warning:** To reduce the risk of personal injury, do not drop the lamp module or touch the lamp bulb. The bulb may shatter and cause injury if it is dropped.



## Ceiling Mount Installation

If you wish to install the projector using a ceiling mount, please refer to the steps below:

- 1 Drill four holes into a solid, structural ceiling member, and secure the ceiling mount base to the ceiling.

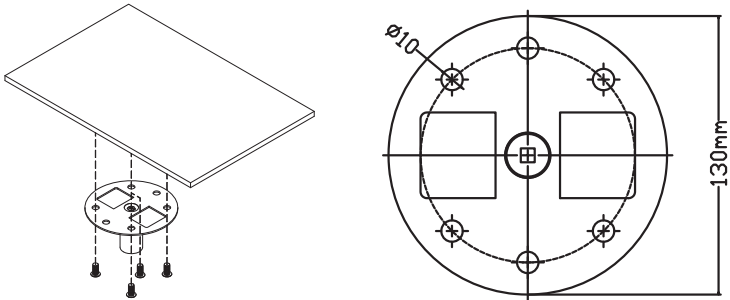

- 2 Choose the length combination based on actual environment. (CM-015 doesn't include Type 2 and Type 3.)

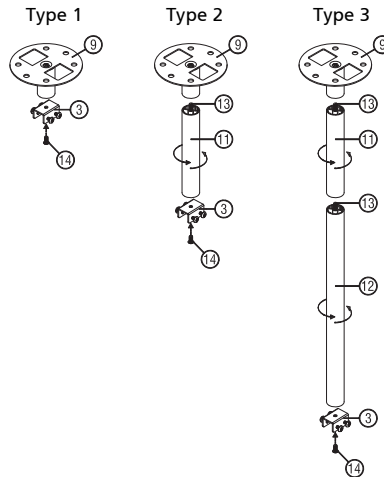

- 3 Type 1:  
For the standard size use three bracket screws to mount the projector to the ceiling mount bracket.  
Type 2 and Type 3:  
Alternatively, for the larger size, use the sliding extensions for more supports.

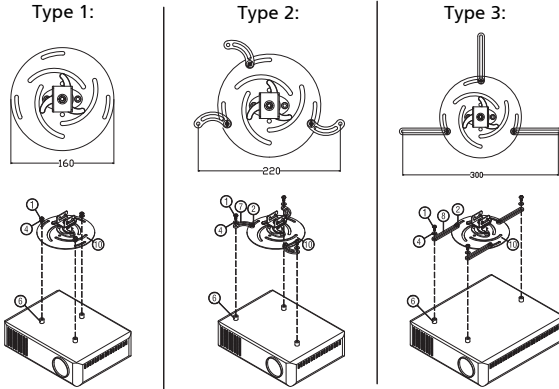

**Note:** It is recommended that you keep a reasonable space between the bracket and the projector to allow for proper heat distribution.

- 4 Connect the main body connector to the projector bracket (illustration 1), and then screw up four screws (illustration 2).

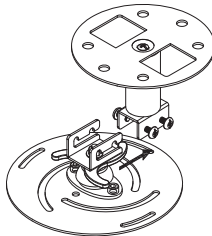

Illustration 1

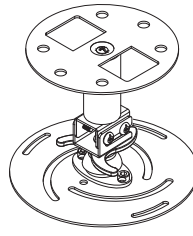
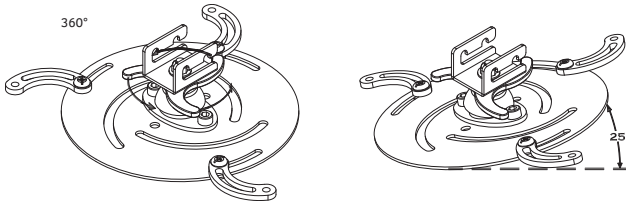
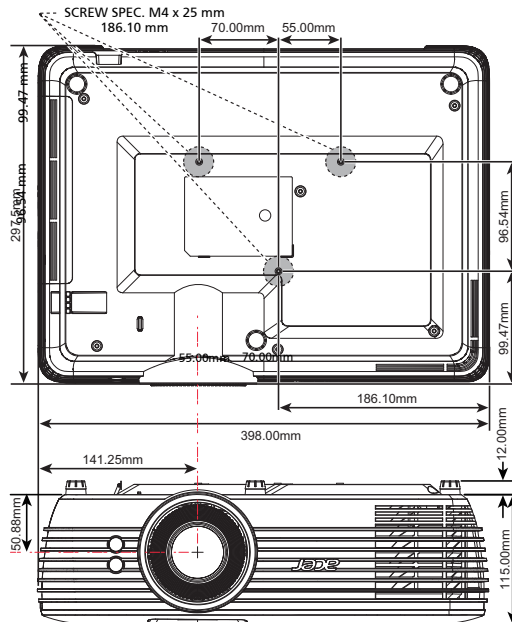

Illustration 2

- 5 Adjust the angle and positioning as necessary.



Screw Type B		Washer Type	
Diameter (mm)	Length (mm)	Large	Small
4	25	V	V



# Specifications

The specifications listed below are subject to change without notice. For final specs, please refer to Acer's published marketing specifications.

Projection system	DLP® 4K UHD
Resolution	Native 3840x2160 resolution <ul style="list-style-type: none"> <li>• Maximum: UXGA (1600 x 1200), WSXGA+ (1680x1050), 1080p(1920x1080), WUXGA-RB (1920 x 1200), UHD(3840x2160),4K(4120x2160)</li> </ul>
Computer compatibility	IBM PC and compatibles, Apple Macintosh, iMac and VESA standards: SXGA, XGA, VGA, SVGA, SXGA+, WXGA, WXGA+, WSXGA +
Video compatibility	HDTV (720p, 1080i, 1080p), EDTV (480p, 576p), SDTV (480i, 576i), 2160p
Aspect ratio	Auto, Full, 4:3, 16:9, L.Box, Anamorphic 2.35:1
Displayable colors	1.07 billion colors
Optical zoom ratio	<ul style="list-style-type: none"> <li>• H7850/V7850/E270/V270/HE-4K20/HT-4K20/M550/V550/D4K1701/D4K1702 series: 1.6X</li> <li>• H6815/V6815/E8615/E8615C/ET-4K15/HT-4K15/GM834/HV834/VH-735/TH-735/D4K1735/D4K1732 series: 1.3X</li> </ul>
Throw ratio	<ul style="list-style-type: none"> <li>• H7850/V7850/E270/V270/HE-4K20/HT-4K20/M550/V550/D4K1701/D4K1702 series: 1.39 ~ 2.22:1 (65" @2m)</li> <li>• H6815/V6815/E8615/E8615C/ET-4K15/HT-4K15/GM834/HV834/VH-735/TH-735/D4K1735/D4K1732 series: 1.21 ~ 1.59:1 (75" @2.0m)</li> </ul>
Projection lens	<ul style="list-style-type: none"> <li>• H7850/V7850/E270/V270/HE-4K20/HT-4K20/M550/V550/D4K1701/D4K1702 series: F = 2.50 ~ 3.26, f = 20.91mm ~ 32.62mm, Manual Zoom &amp; Focus</li> <li>• H6815/V6815/E8615/E8615C/ET-4K15/HT-4K15/GM834/HV834/VH-735/TH-735/D4K1735/D4K1732 series: F = 1.94 ~ 2.23, f = 12.81mm ~ 16.74mm, Manual Zoom &amp; Focus</li> </ul>
Projection screen size (diagonal)	<ul style="list-style-type: none"> <li>• H7850/V7850/E270/V270/HE-4K20/HT-4K20/M550/V550/D4K1701/D4K1702 series: 20" (52cm) ~ 300" (762cm)</li> <li>• H6815/V6815/E8615/E8615C/ET-4K15/HT-4K15/GM834/HV834/VH-735/TH-735/D4K1735/D4K1732 series: 37" (94cm)~ 300" (762cm)</li> </ul>
Projection distance	<ul style="list-style-type: none"> <li>• H7850/V7850/E270/V270/HE-4K20/HT-4K20/M550/V550/D4K1701/D4K1702 series: 1.0m ~ 9.2m (3.3' ~ 30.3')</li> <li>• H6815/V6815/E8615/E8615C/ET-4K15/HT-4K15/GM834/HV834/VH-735/TH-735/D4K1735/D4K1732 series: 1.0m ~ 8.0m (3.3' ~ 26.4')</li> </ul>

Horizontal scan rate	15 - 135 kHz
Vertical refresh scan rate	24 - 120 Hz
Lamp type	240 W user-replaceable lamp
Audio	Internal speaker with 5W x 2 output
Weight	5.5 Kg (12.1 lbs)
Dimensions (W x D x H)	398 mm X 297.5 mm X 127 mm (15.7" x 11.7" x 5.0")
Digital zoom	1.25X
Power supply	AC input 100 - 240 V auto-switching power supply
Power consumption	<ul style="list-style-type: none"> <li>• H7850/V7850/E270/V270/HE-4K20/HT-4K20/M550/V550/D4K1701/D4K1702 series: Normal mode: 325W ± 10% @ 110VAC ECO mode: 235W ± 10% @ 110VAC Standby mode &lt; 0.5W</li> <li>• H6815/V6815/E8615/E8615C/ET-4K15/HT-4K15/GM834/HV834/VH-735/TH-735/D4K1735/D4K1732 series: Normal mode: 310W ± 10% @ 110VAC ECO mode: 230W ± 10% @ 110VAC Standby mode &lt; 0.5W</li> </ul>
Operating temperature	0°C to 40°C / 32°F to 104°F
Standard package contents	<ul style="list-style-type: none"> <li>• AC power cord x1</li> <li>• HDMI cable x1</li> <li>• Remote control x1</li> <li>• AAA battery x2 (for remote control) (option)</li> <li>• User's guide (CD-ROM) x1</li> <li>• Quick start guide x1</li> <li>• Carrying case x1 (option)</li> </ul>

I/O connectors	H7850/V7850/E270/V270/ HE-4K20/ HT-4K20/M550/V550/D4K1701/ D4K1702	H6815/V6815/E8615/E8615C/ ET-4K15/ HT-4K15/GM834/HV834/VH-735/ TH-735/D4K1735/D4K1732
Power socket	V	V
VGA IN	V	V
HDMI1	V	V
HDMI2/MHL	V	V
RJ45 LAN input	V	X
VGA output	V	X
RS232	V	V
3.5 mm audio jack input	V	V
3.5 mm audio jack output	V	V
5V DC output	V	V
12V DC output	V	V
Service connector	V	V
S/PDIF output	X	V



**Note:** Design and specifications are subject to change without notice.

# Compatibility modes

## A. VGA Analog

### 1 VGA Analog - PC Signal

Modes	Resolution	V.Frequency [Hz]	H.Frequency [KHz]
VGA	640x480	60	31.5
	640x480	72	37.9
	640x480	75	37.5
	640x480	85	43.3
	640x480	120	61.9
SVGA	800x600	56	35.1
	800x600	60	37.9
	800x600	72	48.1
	800x600	75	46.9
	800x600	85	53.7
XGA	800x600	120	77.4
	1024x768	60	48.4
	1024x768	70	56.5
	1024x768	75	60.0
	1024x768	85	68.7
SXGA	1024x768	120	99.0
	1152x864	70	63.8
	1152x864	75	67.5
	1152x864	85	77.1
	1280x1024	60	64.0
QuadVGA	1280x1024	72	77.0
	1280x1024	75	80.0
	1280x1024	85	91.1
	1280x960	60	60.0
	1280x960	75	75.2
SXGA+	1400x1050	60	65.3
UXGA	1600x1200	60	75.0
PowerBook G4	640x480	60	31.4
PowerBook G4	640x480	66.6(67)	34.9
PowerBook G4	800x600	60	37.9
PowerBook G4	1024x768	60	48.4
PowerBook G4	1152x870	75	68.7
PowerBook G4	1280x960	75	75.0
i Mac DV (G3)	1024x768	75	60.0

## 2 VGA Analog - Extended Wide timing

Modes	Resolution	V.Frequency [Hz]	H.Frequency [KHz]
WXGA	1280x768	60	47.8
	1280x768	75	60.3
	1280x768	85	68.6
	1280x720	60	44.8
	1280x800-RB	120	101.6
	1280x800	120	92.9
	1280x800	60	49.6
	1920x1200	60	74
	1440x900	60	59.9
	1680x1050	60	65.3
WSXGA+	1920x1080 (1080P)	60	67.5
	1366x768	60	47.7
	1920x1200-RB	59.9	74.00

## 3 VGA Analog -Component Signal

Modes	Resolution	V.Frequency [Hz]	H.Frequency [KHz]
480i	720x480(1440x480)	59.94 (29.97)	15.7
576i	720x576(1440x576)	50(25)	15.6
480p	720x480	59.94	31.5
576p	720x576	50	31.3
720p	1280x720	60	45.0
720p	1280x720	50	37.5
1080i	1920x1080	60(30)	33.8
1080i	1920x1080	50(25)	28.1
1080p	1920x1080	23.97/24	27.0
1080p	1920x1080	60	67.5
1080p	1920x1080	50	56.3
Graphic source monitor range limits	Horizontal scan rate:		15k-104kHz
	Vertical scan rate:		24-120 Hz
	Max. pixel rate:		Analog:170MHz

## B. HDMI1.4 Digital

### 1 HDMI - PC Signal

Modes	Resolution	V.Frequency [Hz]	H.Frequency [KHz]
VGA	640x480	60	31.5



	640x480	72	37.9
	640x480	75	37.5
	640x480	85	43.3
	640x480	120	61.9
SVGA	800x600	56	35.1
	800x600	60	37.9
	800x600	72	48.1
	800x600	75	46.9
	800x600	85	53.7
	800x600	120	77.4
XGA	1024x768	60	48.4
	1024x768	70	56.5
	1024x768	75	60.0
	1024x768	85	68.7
	1024x768	120	99.0
SXGA	1152x864	70	63.8
	1152x864	75	67.5
	1152x864	85	77.1
	1280x1024	60	64.0
	1280x1024	72	77.0
	1280x1024	75	80.0
	1280x1024	85	91.1
QuadVGA	1280x960	60	60.0
	1280x960	75	75.2
SXGA+	1400x1050	60	65.3
UXGA	1600x1200	60	75.0
PowerBook G4	640x480	60	31.4
PowerBook G4	640x480	66.6(67)	34.9
PowerBook G4	800x600	60	37.9
PowerBook G4	1024x768	60	48.4
PowerBook G4	1152x870	75	68.7
PowerBook G4	1280x960	75	75.0
i Mac DV (G3)	1024x768	75	60.0

## 2 HDMI - Extended Wide timing

Modes	Resolution	V.Frequency [Hz]	H.Frequency [KHz]
WXGA	1280x768	60	47.8
	1280x768	75	60.3
	1280x768	85	68.6
	1280x720	60	44.8
	1280x800-RB	120	101.6
	1280x800	120	92.9
	1280x800	60	49.6

	1440x900	60	59.9
	1920x1200	60	74
WSXGA+	1680x1050	60	65.3
	1920x1080 (1080P)	60	67.5
	1920x1080	120	135
	1366x768	60	47.7
WUXGA	1920x1200-RB	59.9	74.0
UHD	3840x2160	30.0	67.5

### 3 HDMI - Video Signal

Modes	Resolution	V.Frequency [Hz]	H.Frequency [KHz]
480i	720(1440)x480 4:3	59.94(29.97)	15.7
480i	720(1440)x480 16:9	59.94(29.97)	15.7
480i	2880x480 16:9	59.94(29.97)	15.7
576i	720(1440)x576 4:3	50(25)	15.6
576i	720x576(1440x576) 16:9	50(25)	15.6
576i	2880x576 16:9	50(25)	16.6
480p	720x480 4:3	59.9	31.5
480p	720x480 16:9	59.9	31.5
480p	1440x480 16:9	59.9	31.5
576p	720x576 4:3	50	31.3
576p	720x576 16:9	50	31.3
576p	1440x576 16:9	50	31.3
720p	1280x720	60	45.0
720p	1280x720	50	37.5
1080i	1920x1080	60(30)	33.8
1080i	1920x1080	50(25)	28.1
1080p	1920x1080	23.97/24	27.0
1080p	1920x1080	60	67.5
1080p	1920x1080	50	56.3
1080p	1920x1080	25	28.1
1080p	1920x1080	30	33.8
UHD	3840x2160	24.0	54.0
UHD	3840x2160	25.0	56.3
UHD	3840x2160	30.0	67.5
4K2K	4096x2160	24.0	54.0
4K2K	4096x2160	25.0	56.3
4K2K	4096x2160	30.0	67.5

Graphic source monitor range limits	Horizontal scan rate:	15k-135kHz
	Vertical scan rate:	24-120 Hz
	Max. pixel rate:	Digital:300MHz

## C. HDMI2.0 Digital

### 1 HDMI - PC Signal

Modes	Resolution	V.Frequency [Hz]	H.Frequency [KHz]
VGA	640x480	60	31.5
	640x480	72	37.9
	640x480	75	37.5
	640x480	85	43.3
SVGA	800x600	56	35.1
	800x600	60	37.9
	800x600	72	48.1
	800x600	75	46.9
	800x600	85	53.7
XGA	800x600	120	77.4
	1024x768	60	48.4
	1024x768	70	56.5
	1024x768	75	60.0
	1024x768	85	68.7
SXGA	1024x768	120	99.0
	1152x864	70	63.8
	1152x864	75	67.5
	1152x864	85	77.1
	1280x1024	60	64.0
QuadVGA	1280x1024	72	77.0
	1280x1024	75	80.0
	1280x1024	85	91.1
	1280x960	60	60.0
SXGA+	1280x960	75	75.2
	1400x1050	60	65.3
UXGA	1600x1200	60	75.0
PowerBook G4	640x480	60	31.4
PowerBook G4	640x480	66.6(67)	34.9
PowerBook G4	800x600	60	37.9
PowerBook G4	1024x768	60	48.4
PowerBook G4	1152x870	75	68.7
PowerBook G4	1280x960	75	75.0
i Mac DV (G3)	1024x768	75	60.0

## 2 HDMI - Extended Wide timing

Modes	Resolution	V.Frequency [Hz]	H.Frequency [KHz]
WXGA	1280x768	60	47.8
	1280x768	75	60.3
	1280x768	85	68.6
	1280x720	60	44.8
	1280x800-RB	120	101.6
	1280x800	120	92.9
	1280x800	60	49.6
	1440x900	60	59.9
	1920x1200	60	74.0
	WSXGA+	1680x1050	60
1920x1080 (1080P)		60	67.5
1920x1080		120	135
1366x768		60	47.7
WUXGA	1920x1200-RB	59.9	74.0
UHD	3840x2160	60.0	135.0

## 3 HDMI - Video Signal

Modes	Resolution	V.Frequency [Hz]	H.Frequency [KHz]
480i	720(1440)x480 4:3	59.94(29.97)	15.7
480i	720(1440)x480 16:9	59.94(29.97)	15.7
480i	2880x480 16:9	59.94(29.97)	15.7
576i	720(1440)x576 4:3	50(25)	15.6
576i	720x576(1440x576) 16:9	50(25)	15.6
576i	2880x576 16:9	50(25)	16.6
480p	720x480 4:3	59.9	31.5
480p	720x480 16:9	59.9	31.5
480p	1440x480 16:9	59.9	31.5
576p	720x576 4:3	50	31.3
576p	720x576 16:9	50	31.3
576p	1440x576 16:9	50	31.3
720p	1280x720	60	45.0
720p	1280x720	50	37.5
1080i	1920x1080	60(30)	33.8
1080i	1920x1080	50(25)	28.1
1080p	1920x1080	23.97/24	27.0

1080p	1920x1080	60	67.5
1080p	1920x1080	50	56.3
1080p	1920x1080	25	28.1
1080p	1920x1080	30	33.8
UHD	3840x2160	24.0	54.0
UHD	3840x2160	25.0	56.3
UHD	3840x2160	30.0	67.5
UHD	3840x2160	50.0	112.5
UHD	3840x2160	60.0	135.0
4K2K	4096x2160	24.0	54.0
4K2K	4096x2160	25.0	56.3
4K2K	4096x2160	30.0	67.5
4K2K	4096x2160	50.0	112.5
4K2K	4096x2160	60.0	135.0
Graphic source monitor range limits	Horizontal scan rate:		15k-135kHz
	Vertical scan rate:		24-120 Hz
	Max. pixel rate:		Digital:600MHz

## D. MHL Digital

Modes	Resolution	V.Frequency [Hz]	H.Frequency [KHz]
VGA	640x480	59.94/60	31.5
480i	720x480 (1440x480)	59.94/60	15.7
480i_4x	2880x480i	59.94/60	15.7
576i	720x576 (1440x576)	50(25)	15.6
576i_4x	2880x576i	50(25)	15.6
480p	720x480	59.94/60	31.5
480p_2x	1440x480	59.94/60	31.5
576p	720x576	50	31.3
576p_2x	1440x576	50	31.3
720p	1280x720	59.94/60	45.0
720p	1280x720	50	37.5
1080i	1920x1080	60(30)	33.8
1080i	1920x1080	50(25)	28.1
1080p	1920x1080	23.97/24	27.0
1080p	1920x1080	25	28.1
1080p	1920x1080	29.97/30	33.8
Graphic source monitor range limits	Horizontal scan rate:		15k-50 kHz
	Vertical scan rate:		24-60 Hz
	Max. pixel rate:		Digital: 75 MHz



**Note:** Functions vary depending on model definition.

# Regulations and safety notices

## FCC notice

This device has been tested and found to comply with the limits for a Class B digital device pursuant to Part 15 of the FCC rules. These limits are designed to provide reasonable protection against harmful interference in a residential installation. This device generates, uses, and can radiate radio frequency energy and, if not installed and used in accordance with the instructions, may cause harmful interference to radio communications.

However, there is no guarantee that interference will not occur in a particular installation. If this device does cause harmful interference to radio or television reception, which can be determined by turning the device off and on, the user is encouraged to try to correct the interference by one or more of the following measures:

- Reorient or relocate the receiving antenna.
- Increase the separation between the device and receiver.
- Connect the device into an outlet on a circuit different from that to which the receiver is connected.
- Consult the dealer or an experienced radio/television technician for help.

## Notice: Shielded cables

All connections to other computing devices must be made using shielded cables to maintain compliance with FCC regulations.

## Notice: Peripheral devices

Only peripherals (input/output devices, terminals, printers, etc.) certified to comply with the Class B limits may be attached to this equipment. Operation with non-certified peripherals is likely to result in interference to radio and TV reception.

## Caution

Changes or modifications not expressly approved by the manufacturer could void the user's authority, which is granted by the Federal Communications Commission, to operate this device.

## Operation conditions

This device complies with Part 15 of the FCC Rules. Operation is subject to the following two conditions: (1) this device may not cause harmful interference, and (2) this device must accept any interference received, including interference that may cause undesired operation.

## Notice: Canadian users

This Class B digital apparatus complies with Canadian ICES-003.

## Remarque à l'intention des utilisateurs canadiens

Cet appareil numérique de la classe B est conforme à la norme NMB-003 du Canada.

Compliant with Russian/ Ukraine regulatory certification



### Radio device regulatory notice



-----

**Note:** The regulatory information below is for models with wireless LAN and/or Bluetooth only.

### General

This product complies with the radio frequency and safety standards of any country or region in which it has been approved for wireless use. Depending on configurations, this product may or may not contain wireless radio devices (such as wireless LAN and/or Bluetooth modules).

### Canada — Low-power license-exempt radio communication devices (RSS-247)

- a Common information  
Operation is subject to the following two conditions:
  1. This device may not cause interference, and
  2. This device must accept any interference, including interference that may cause undesired operation of the device.
- b Operation in 2.4 GHz band  
To prevent radio interference to the licensed service, this device is intended to be operated indoors and installation outdoors is subject to licensing.

### List of applicable countries

This device must be used in strict accordance with the regulations and constraints in the country of use. For further information, please contact the local office in the country of use. Please see <http://ec.europa.eu/enterprise/rtte/implem.htm> for the latest country list.





**Acer Incorporated**  
8F, 88, Sec. 1, Xintai 5th Rd., Xizhi  
New Taipei City 221, Taiwan

## Declaration of Conformity

We,

**Acer Incorporated**

8F, 88, Sec. 1, Xintai 5th Rd., Xizhi, New Taipei City 221, Taiwan

And,

**Acer Italy s.r.l.**

Via Lepetit, 40, 20020 Lainate (MI) Italy

Tel: +39-02-939-921 ,Fax: +39-02 9399-2913

www.acer.it

**Product:** DLP Projector  
**Trade Name:** Acer  
**Model Number:** D4K1701/D4K1702/D4K1735/D4K1732  
**Marketing name:** H7850/V7850/H6815/V6815/E270/V270/E8615/E8615C/HE-4K20/  
HT-4K20/ET-4K15/HT-4K15/M550/V550/GM834/HV834/VH-735/TH-735

We, Acer Incorporated, hereby declare under our sole responsibility that the product described above is in conformity with the relevant Union harmonization legislations as below Directive and following harmonized standards and/or other relevant standards have been applied:

**EMC Directive: 2014/30/EU**

<input checked="" type="checkbox"/> EN 55032:2012+AC:2013, Class B	<input checked="" type="checkbox"/> EN 61000-3-2:2014, Class A
<input checked="" type="checkbox"/> EN 55024:2010+A1:2015	<input checked="" type="checkbox"/> EN 61000-3-3:2013

**R&TTE Directive: 1999/5/EC (until Jun 12, 2017)**

**RED Directive: 2014/53/EU (From Jun 13, 2017)**

<input type="checkbox"/> EN 300 328 V1.8.1	<input type="checkbox"/> EN 301 511 V9.0.2	<input type="checkbox"/> EN 301 489-7 V1.3.1
<input type="checkbox"/> EN 301 893 V1.7.1	<input type="checkbox"/> EN 301 908-1 V6.2.1	<input type="checkbox"/> EN 301 489-17 V2.2.1
<input type="checkbox"/> EN 300 440-1 V1.6.1	<input type="checkbox"/> EN 301 908-2 V6.2.1	<input type="checkbox"/> EN 301 489-24 V1.5.1
<input type="checkbox"/> EN 300 440-2 V1.4.1	<input type="checkbox"/> EN 301 908-13 V6.2.1	<input type="checkbox"/> EN 50360:2001
<input type="checkbox"/> EN 302 291-1 V1.1.1	<input type="checkbox"/> EN 301 489-1 V1.9.2	<input type="checkbox"/> EN 50566:2013
<input type="checkbox"/> EN 302 291-2 V1.1.1	<input type="checkbox"/> EN 301 489-3 V1.6.1	<input type="checkbox"/> EN 62479:2010
		<input type="checkbox"/> EN 62311:2008
		<input type="checkbox"/> EN 62209-1:2006
		<input type="checkbox"/> EN 62209-2:2010

**LVD Directive: 2014/35/EU**

<input checked="" type="checkbox"/> EN 60950-1:2006/A11:2009/A1:2010/A12:2011/A2:2013
<input type="checkbox"/> EN 50332-1:2000
<input type="checkbox"/> EN 50332-2:2003

**RoHS Directive: 2011/65/EU**

<input checked="" type="checkbox"/> EN 50581:2012
---

**ErP Directive: 2009/125/EC**

<input type="checkbox"/> Regulation (EU) No. 617/2013	<input type="checkbox"/> Regulation (EC) No. 278/2009; EN 50563:2011
<input checked="" type="checkbox"/> Regulation (EC) No. 1275/2008; EN 50564:2011	

Year to begin affixing CE marking 2017.

**RU Jan / Sr. Manager**  
**Acer Incorporated (Taipei, Taiwan)**

**Jan. 15, 2018**

**Date**



**Acer America Corporation**  
333 West San Carlos St.,  
Suite 1500  
San Jose, CA 95110  
U. S. A.  
Tel: 254-298-4000  
Fax: 254-298-4147  
www.acer.com



## Federal Communications Commission Declaration of Conformity

This device complies with Part 15 of the FCC Rules. Operation is subject to the following two conditions: (1) this device may not cause harmful interference, and (2) this device must accept any interference received, including interference that may cause undesired operation.

The following local Manufacturer / Importer is responsible for this declaration:

<b>Product:</b>	DLP Projector
<b>Model Number:</b>	D4K1701/D4K1702/D4K1735/D4K1732
<b>Machine Type:</b>	H7850/V7850/H6815/V6815/E270/V270/E8615/ E8615C/HE-4K20/HT-4K20/ET-4K15/HT-4K15/ M550/V550/GM834/HV834/VH-735/TH-735
<b>Name of Responsible Party:</b>	Acer America Corporation
<b>Address of Responsible Party:</b>	333 West San Carlos St. Suite 1500 San Jose, CA 95110 U. S. A.
<b>Contact Person:</b>	Acer Representative
<b>Phone No.:</b>	254-298-4000
<b>Fax No.:</b>	254-298-4147