

**32BDL4051D**

**43BDL4051D**

**49BDL4051D**

**55BDL4051D**

**V1.01**



[www.philips.com/welcome](http://www.philips.com/welcome)

User Manual (English)

**PHILIPS**

**Signage***Solutions*

# Safety Instructions

## Safety precautions and maintenance



**WARNING:** Use of controls, adjustments or procedures other than those specified in this documentation may result in exposure to shock, electrical hazards and/or mechanical hazards.

### Read and follow these instructions when connecting and using your display:

#### Operation:

- Keep the display out of direct sunlight and away from stoves or any other heat sources.
- Keep the display away from oil, otherwise the plastic cover may be damaged.
- Remove any object that could fall into ventilation holes or prevent proper cooling of the display's electronics.
- Do not block the ventilation holes on the cabinet.
- When positioning the display, make sure the power plug and outlet are easily accessible.
- When turning off the display by detaching the power cord, wait 6 seconds before re-attaching the power cord for normal operation.
- Ensure the use of an approved power cord provided by Philips at all times. If your power cord is missing, please contact your local service center.
- Do not subject the display to severe vibration or high impact conditions during operation.
- Do not knock or drop the display during operation or transportation.
- The eye bolt is for usage in short-time maintenance and installation. We suggest not to use the eye bolt for more than 1 hour. Prolong usage is prohibited. Please keep a clear safety area under the display while using the eye bolt.

#### Maintenance:

- To protect your display from possible damage, do not put excessive pressure on the LCD panel. When moving your display, grasp the frame to lift; do not lift the display by placing your hand or fingers on the LCD panel.
- Unplug the display if you are not going to use it for an extensive period of time.
- Unplug the display if you need to clean it with a slightly damp cloth. The screen may be wiped with a dry cloth when the power is off. However, never use organic solvent, such as, alcohol, or ammonia-based liquids to clean your display.
- To avoid the risk of shock or permanent damage to the set, do not expose the display to dust, rain, water or an excessively moist environment.
- If your display becomes wet, wipe it with dry cloth as soon as possible.
- If a foreign substance or water gets in your display, turn the power off immediately and disconnect the power cord. Then remove the foreign substance or water; and send the unit to the maintenance center.
- Do not store or use the display in locations exposed to heat, direct sunlight or extreme cold.
- In order to maintain the best performance of your display and ensure a longer lifetime, we strongly recommend using the display in a location that falls within the following temperature and humidity ranges.
  - Temperature: 0-40°C 32-104°F
  - Humidity: 20-80% RH
- LCD panel temperature need to be 25 degrees Celsius at all time for better luminance performance.

**IMPORTANT:** Always activate a moving screen saver program when you leave your display unattended. Always activate a periodic screen refresh application if the unit will display unchanging static content. Uninterrupted display of still or static images over an extended period may cause "burn in", also known as "after-imaging" or "ghost imaging", on your screen. This is a well-known phenomenon in LCD panel technology. In most cases, the "burned in" or "after-imaging" or "ghost imaging" will disappear gradually over a period of time after the power has been switched off.

**WARNING:** Severe "burn-in" or "after-image" or "ghost image" symptoms will not disappear and cannot be repaired. This is also not covered under the terms of your warranty.

#### Service:

- The casing cover should be opened only by qualified service personnel.
- If there is any need for repair or integration, please contact your local service center.
- Do not leave your display under direct sunlight.



If your display does not operate normally, having followed the instructions set out in this document, please contact a technician or your local service center.

## Stability Hazard.

The device may fall, causing serious personal injury or death. To prevent injury, this device must be securely attached to the floor/wall in accordance with the installation instructions.

## Read and follow these instructions when connecting and using your display:



- Unplug the display if you are not going to use it for an extensive period of time.
- Unplug the display if you need to clean it with a slightly damp cloth. The screen may be wiped with a dry cloth when the power is off. However, never use alcohol, solvents or ammonia-based liquids.
- Consult a service technician if the display does not operate normally when you have followed the instructions in this manual.
- The casing cover should be opened only by qualified service personnel.
- Keep the display out of direct sunlight and away from stoves or any other heat sources.
- Remove any object that could fall into the vents or prevent proper cooling of the display's electronics.
- Do not block the ventilation holes on the cabinet.
- Keep the display dry. To avoid electric shock, do not expose it to rain or excessive moisture.
- When turning off the display by detaching the power cable or DC power cord, wait for 6 seconds before re-attaching the power cable or DC power cord for normal operation..
- To avoid the risk of shock or permanent damage to the set do not expose the display to rain or excessive moisture.
- When positioning the display, make sure the power plug and outlet are easily accessible.
- **IMPORTANT:** Always activate a screen saver program during your application. If a still image in high contrast remains on the screen for an extended period of time, it may leave an 'after-image' or 'ghost image' on the front of the screen. This is a well-known phenomenon that is caused by the shortcomings inherent in LCD technology. In most cases the afterimage will disappear gradually over a period of time after the power has been switched off. Be aware that the after-image symptom cannot be repaired and is not covered under warranty.
- If provided with a 3-pin attachment plug on the power cord, plug the cord into a grounded (earthed) 3-pin outlet. Do not disable the power cord grounding pin, for example, by attaching a 2-pin adapter. The grounding pin is an important safety feature.



## EU Declaration of Conformity

This device complies with the requirements set out in the Council Directive on the Approximation of the Laws of the Member States relating to Electromagnetic Compatibility (2014/30/EU), Low-voltage Directive (2014/35/EU), RoHS directive (2011/65/EU), and Radio Equipment Directive (2014/53/EU).

This product has been tested and found to comply with the harmonized standards for Information Technology Equipment, these harmonized standards published under Directives of Official Journal of the European Union.

## ESD Warnings

When user close to the monitor may cause the equipment discharge and reboot to the display of main menu.

## Warning:

This equipment is compliant with Class A of EN55032/CISPR 32. In a residential environment this equipment may cause radio interference.

## Federal Communications Commission (FCC) Notice (U.S. Only)



**NOTE:** This equipment has been tested and found to comply with the limits for a Class A digital device, pursuant to part 15 of the FCC Rules. These limits are designed to provide reasonable protection against harmful interference when the equipment is operated in a commercial environment. This equipment generates, uses, and can radiate radio frequency energy and, if not installed and used in accordance with the instruction manual, may cause harmful interference to radio communications. Operation of this equipment in a residential area is likely to cause harmful interference in which case the user will be required to correct the interference at his own expense.



Changes or modifications not expressly approved by the party responsible for compliance could void the user's authority to operate the equipment.

Use only an RF shielded cable that was supplied with the display when connecting this display to a computer device.

To prevent damage which may result in fire or shock hazard, do not expose this appliance to rain or excessive moisture.

This device complies with Part 15 of the FCC Rules. Operation is subject to the following two conditions: (1) This device may not cause harmful interference, and (2) this device must accept any interference received, including interference that may cause undesired operation.

Envision Peripherals Inc.  
490 N McCarthy Blvd, Suite #120  
Milpitas, CA 95035  
USA

## Europe – EU Declaration of Conformity

This device complies with the essential requirements of the Radio Equipment Directive (2014/53/EU). The following test methods have been applied in order to prove presumption of conformity with the essential requirements of the Radio Equipment Directive (2014/53/EU):

- EN60950-1/EN62311/EN300328/EN301893/EN301489

## Europe Statement

### IMPORTANT NOTE:

The device is restricted to indoor use only when operating in the 5150 to 5350MHz frequency range.

	AT	BE	BG	HR	CY	CZ	DK
	EE	FI	FR	DE	EL	HU	IE
	IT	LV	LT	LU	MT	NL	PL
	PT	RO	SK	SI	ES	SE	UK

### Radiation Exposure Statement:

This equipment complies with CE radiation exposure limits set forth for an uncontrolled environment. This equipment should be installed and operated with minimum distance 20cm between the radiator & body.

The frequency, mode and the maximum transmitted power in EU are listed below:

2412-2472MHz(802.11g 6Mbps): 19.98dBm

2402-2480MHz (EDR 3Mbps): 9.65dBm

2402-2480MHz (LE 1Mbps): 9.80dBm

5180-5240/5260-5320/5500-5700MHz (802.11 ac VHT40 MCS0/NSS1): 22.95dBm

## Taiwan:

### 低功率電波輻射性電機管理辦法

第十二條 經型式認證合格之低功率射頻電機，非經許可，公司、商號或使用者均不得擅自變更頻率、加大功率或變更原設計之特性及功能。

第十四條 低功率射頻電機之使用不得影響飛航安全及干擾合法通信；經發現有干擾現象時，應立即停用，並改善至無干擾時方得繼續使用。

前項合法通信，指依電信法規定作業之無線電通信。

低功率射頻電機須忍受合法通信或工業、科學及醫療用電波輻射性電機設備之干擾。

### Caution:

Any changes or modifications not expressly approved by the party responsible for compliance could void the user's authority to operate this equipment.

This transmitter must not be co-located or operating in conjunction with any other antenna or transmitter.

Operations in the 5GHz products are restricted to indoor usage only.

## Radiation Exposure Statement:

This equipment complies with FCC radiation exposure limits set forth for an uncontrolled environment. This equipment should be installed and operated with minimum distance 20cm between the radiator & your body.

## Canada:

Industry Canada statement:

This device complies with RSS-247 of the Industry Canada Rules. Operation is subject to the following two conditions: (1) This device may not cause harmful interference, and (2) this device must accept any interference received, including interference that may cause undesired operation.

Ce dispositif est conforme à la norme CNR-247 d'Industrie Canada applicable aux appareils radio exempts de licence. Son fonctionnement est sujet aux deux conditions suivantes: (1) le dispositif ne doit pas produire de brouillage préjudiciable, et (2) ce dispositif doit accepter tout brouillage reçu, y compris un brouillage susceptible de provoquer un fonctionnement indésirable.

## Radiation Exposure Statement:

This equipment complies with ISED radiation exposure limits set forth for an uncontrolled environment. This equipment should be installed and operated with minimum distance 20cm between the radiator & your body.

Déclaration d'exposition aux radiations: Cet équipement est conforme aux limites d'exposition aux rayonnements ISED établies pour un environnement non contrôlé. Cet équipement doit être installé et utilisé avec un minimum de 20 cm de distance entre la source de rayonnement et votre corps.

## Polish Center for Testing and Certification Notice

The equipment should draw power from a socket with an attached protection circuit (a three-prong socket). All equipment that works together (computer, display, printer, and so on) should have the same power supply source.

The phasing conductor of the room's electrical installation should have a reserve short-circuit protection device in the form of a fuse with a nominal value no larger than 16 amperes (A).

To completely switch off the equipment, the power supply cable must be removed from the power supply socket, which should be located near the equipment and easily accessible.

A protection mark "B" confirms that the equipment is in compliance with the protection usage requirements of standards PN-93/T-42107 and PN-89/E-06251.

### ***Wymagania Polskiego Centrum Badań i Certyfikacji***

Urządzenie powinno być zasilane z gniazda z przyłączonym obwodem ochronnym (gniazdo z kolkiem). Współpracujące ze sobą urządzenia (komputer, monitor, drukarka) powinny być zasilane z tego samego źródła.

Instalacja elektryczna pomieszczenia powinna zawierać w przewodzie fazowym rezerwową ochronę przed zwarciami, w postaci bezpiecznika o wartości znamionowej nie większej niż 16A (amperów).

W celu całkowitego wyłączenia urządzenia z sieci zasilania, należy wyjąć wtyczkę kabla zasilającego z gniazdka, które powinno znajdować się w pobliżu urządzenia i być łatwo dostępne.

Znak bezpieczeństwa "B" potwierdza zgodność urządzenia z wymaganiami bezpieczeństwa użytkownika zawartymi w PN-93/T-42107 i PN-89/E-06251.

### ***Pozostałe instrukcje bezpieczeństwa***

- Nie należy używać wtyczek adapterowych lub usuwać kolka obwodu ochronnego z wtyczki. Jeżeli konieczne jest użycie przedłużacza to należy użyć przedłużacza 3-żyłowego z prawidłowo połączonym przewodem ochronnym.
- System komputerowy należy zabezpieczyć przed nagłymi, chwilowymi wzrostami lub spadkami napięcia, używając eliminatora przepięć, urządzenia dopasowującego lub bezzakłóceńowego źródła zasilania.
- Należy upewnić się, aby nic nie leżało na kablach systemu komputerowego, oraz aby kable nie były umieszczone w miejscu, gdzie można byłoby na nie nadeptywać lub potykać się o nie.
- Nie należy rozlewać napojów ani innych płynów na system komputerowy.
- Nie należy wpychać żadnych przedmiotów do otworów systemu komputerowego, gdyż może to spowodować pożar lub porażenie prądem, poprzez zwarcie elementów wewnętrznych.
- System komputerowy powinien znajdować się z dala od grzejników i źródeł ciepła. Ponadto, nie należy blokować otworów wentylacyjnych. Należy unikać kładzenia luźnych papierów pod komputer oraz umieszczania komputera w ciasnym miejscu bez możliwości cyrkulacji powietrza wokół niego.

## Electric, Magnetic and Electromagnetic Fields (“EMF”)

1. We manufacture and sell many products targeted at consumers, which, like any electronic apparatus, in general have the ability to emit and receive electromagnetic signals.
2. One of our leading Business Principles is to take all necessary health and safety measures for our products, to comply with all applicable legal requirements and to stay well within the EMF standards applicable at the time of producing the products.
3. We are committed to develop, produce and market products that cause no adverse health effects.
4. We confirm that if its products are handled properly for their intended use, they are safe to use according to scientific evidence available today.
5. We play an active role in the development of international EMF and safety standards, enabling us to anticipate further developments in standardization for early integration in its products.

### Information for U.K. only

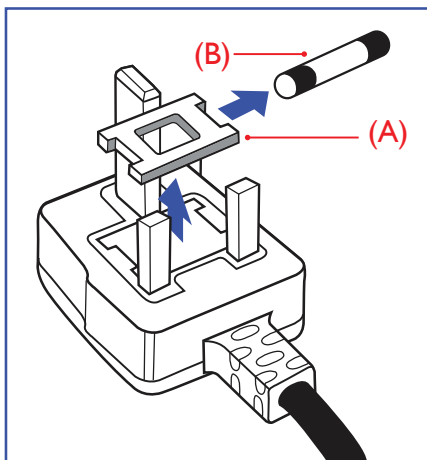

#### **WARNING - THIS APPLIANCE MUST BE EARTHED.**

##### **Important:**

This apparatus is supplied with an approved moulded 13A plug. To change a fuse in this type of plug proceed as follows:+

1. Remove fuse cover and fuse.
2. Fit new fuse which should be a BS 1362 5A, A.S.T.A. or BSI approved type.
3. Refit the fuse cover.

If the fitted plug is not suitable for your socket outlets, it should be cut off and an appropriate 3-pin plug fitted in its place.

If the mains plug contains a fuse, this should have a value of 5A. If a plug without a fuse is used, the fuse at the distribution board should not be greater than 5A.

NOTE: The severed plug must be destroyed to avoid a possible shock hazard should it be inserted into a 13A socket elsewhere.

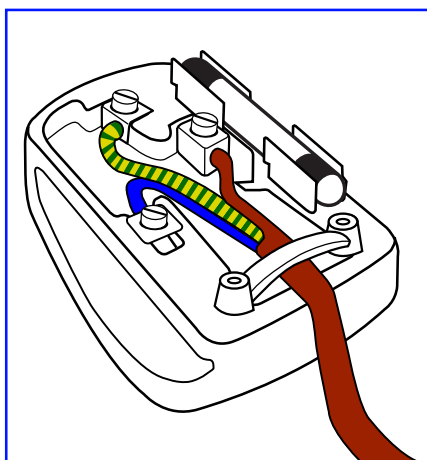

##### **How to connect a plug**

The wires in the mains lead are coloured in accordance with the following code:

- BLUE - “NEUTRAL” (“N”)
- BROWN - “LIVE” (“L”)
- GREEN & YELLOW - “EARTH” (“E”)

1. The GREEN & YELLOW wire must be connected to the terminal in the plug which is marked with the letter “E” or by the Earth symbol or coloured GREEN or GREEN & YELLOW.
2. The BLUE wire must be connected to the terminal which is marked with the letter “N” or coloured BLACK.
3. The BROWN wire must be connected to the terminal which is marked with the letter “L” or coloured RED.

Before replacing the plug cover, make certain that the cord grip is clamped over the sheath of the lead - not simply over the three wires.

### North Europe (Nordic Countries) Information

Placering/Ventilation

#### **VARNING:**

FÖRSÄKRA DIG OM ATT HUVUDBRYTARE OCH UTTAG ÄR LÄTÅTKOMLIGA, NÄR DU STÄLLER DIN UTRUSTNING PÅPLATS.

Placering/Ventilation

#### **ADVARSEL:**

SØRG VED PLACERINGSFOR, AT NETLEDNINGENS STIK OG STIKKONTAKT ER NEMT TILGÆNGELIGE.

Paikka/Ilmankierto

**VAROITUS:**

SJJOITA LAITE SITEN, ETTÄ VERKKOJOHTO VOIDAAN TARVITTAESSA HELPOSTI IRROTTAA PISTORASIESTA.

Plassering/Ventilasjon

**ADVARSEL:**

NÅR DETTE UTSTYRET PLASSERES, MÅ DU PASSE PÅ AT KONTAKTENE FOR STØMTILFØRSEL ER LETTE Å NÅ.

## China RoHS

根据中国大陆《电器电子产品有害物质限制使用管理办法》，以下部分列出了本产品中可能包含的有害物质的名称和含量。

部件名称	有害物质					
	铅 (Pb)	汞 (Hg)	镉 (Cd)	六价铬 (Cr (VI))	多溴联苯 (PBB)	多溴二苯醚 (PBDE)
外壳	○	○	○	○	○	○
液晶显示屏	×	○	○	○	○	○
电路板组件*	×	○	○	○	○	○
电源适配器	×	○	○	○	○	○
电源线/连接线	×	○	○	○	○	○
遥控器	×	○	○	○	○	○

本表格依据SJ/T 11364 的规定编制。

\*: 电路板组件包括印刷电路板及其构成的零部件，如电阻、电容、集成电路、连接器等。

○: 表示该有害物质在该部件所有均质材料中的含量均在 GB/T 26572规定的限量要求以下。

×: 表示该有害物质至少在该部件的某一均质材料中的含量超出GB/T 26572规定的限量要求。

上表中打“×”的部件，应功能需要，部分有害物质含量超出GB/T 26572规定的限量要求，但符合欧盟RoHS法规要求（属于豁免部分）。

备注：上表仅做为范例，实际标示时应依照各产品的实际部件及所含有害物质进行标示。



## 环保使用期限

此标识指期限(十年)，电子电气产品中含有的有害物质在正常使用的条件下不会发生外泄或突变，电子电气产品用户使用该电子电气产品不会对环境造成严重污染或对其人身、财产造成严重损害的期限。

## 《废弃电器电子产品回收处理管理条例》提示性说明

为了更好地关爱及保护地球，当用户不再需要此产品或产品寿命终止时，请遵守国家废弃电器电子产品回收处理相关法律法规，将其交给当地具有国家认可的回收处理资质的厂商进行回收处理，不当利用或者处置可能会对环境和人类健康造成影响。

### 警告

此为A级产品。在生活环境中，该产品可能会造成无线电干扰。在这种情况下，可能需要用户对干扰采取切实可行的措施。

單元	限用物質及其化學符號					
	鉛 (Pb)	汞 (Hg)	鎘 (Cd)	六價鉻 (Cr <sup>+6</sup> )	多溴聯苯 (PBB)	多溴二苯醚 (PBDE)
塑料外框	○	○	○	○	○	○
後殼	○	○	○	○	○	○
液晶面板	—	○	○	○	○	○
電路板組件	—	○	○	○	○	○
底座	○	○	○	○	○	○
電源線	—	○	○	○	○	○
其他線材	—	○	○	○	○	○
遙控器	—	○	○	○	○	○
喇叭（選配）	—	○	○	○	○	○
風扇（選配）	—	○	○	○	○	○

備考1. “○” 係指該項限用物質之百分比含量未超出百分比含量基準值。  
備考2. “—” 係指該項限用物質為排除項目。

警語：使用過度恐傷害視力。

注意事項：

- (1) 使用30分鐘請休息10分鐘。
- (2) 未滿2歲幼兒不看螢幕，2歲以上每天看螢幕不要超過1小時。

警告使用者：

此為甲類資訊技術設備，於居住環境中使用時，可能會造成射頻擾動，在此種情況下，使用者會被要求採取某些適當的對策。

### Turkey RoHS:

Türkiye Cumhuriyeti: EEE Yönetmeliğine Uygundur

### Ukraine RoHS:

Обладнання відповідає вимогам Технічного регламенту щодо обмеження використання деяких небезпечних речовин в електричному та електронному обладнанні, затвердженого постановою Кабінету Міністрів України від 3 грудня 2008 № 1057



## End-of-Life Disposal

Your new Public Information Display contains materials that can be recycled and reused. Specialized companies can recycle your product to increase the amount of reusable materials and to minimize the amount to be disposed of.

Please find out about the local regulations on how to dispose of your old display from your local Philips dealer.

### (For customers in Canada and U.S.A.)

This product may contain lead and/or mercury. Dispose of in accordance to local-state and federal regulations. For additional information on recycling contact [www.eia.org](http://www.eia.org) (Consumer Education Initiative)

## Waste Electrical and Electronic Equipment-WEEE

### Attention users in European Union private households



This marking on the product or on its packaging illustrates that, under European Directive 2012/19/EU governing used electrical and electronic appliances, this product may not be disposed of with normal household waste. You are responsible for disposal of this equipment through a designated waste electrical and electronic equipment collection. To determine the locations for dropping off such waste electrical and electronic, contact your local government office, the waste disposal organization that serves your household or the store at which you purchased the product.

### Attention users in United States:

Please dispose of according to all Local, State and Federal Laws. For the disposal or recycling information, contact: [www.mygreenelectronics.com](http://www.mygreenelectronics.com) or [www.eiae.org](http://www.eiae.org).

### End of Life Directives-Recycling



Your new Public Information Display contains several materials that can be recycled for new users.

Please dispose of according to all Local, State, and Federal laws.



ENERGY STAR is a program run by the U.S. Environmental Protection Agency (EPA) and U.S. Department of Energy (DOE) that promotes energy efficiency.

This product qualifies for ENERGY STAR in the "factory default" settings and this is the setting in which power savings will be achieved.

Changing the factory default picture settings or enabling other features will increase power consumption that could exceed the limits necessary to qualify for ENERGY STAR rating.

For more information on the ENERGY STAR program, refer to [energystar.gov](http://energystar.gov).

### Restriction on Hazardous Substances statement (India)

This product complies with the "E-Waste (Management) Rules, 2016" CHAPTER V, rule 16, sub-rule (1). Whereas New Electrical and Electronic Equipment and their components or consumables or parts or spares do not contain Lead, Mercury, Cadmium, Hexavalent Chromium, polybrominated biphenyls and polybrominated diphenyl ethers beyond a maximum concentration value of 0.1% by weight in homogenous materials for lead, mercury, hexavalent chromium, polybrominated biphenyls and polybrominated diphenyl ethers and of 0.01% by weight in homogenous materials for cadmium, except of exemptions set in Schedule 2 of the Rule.

### E-Waste Declaration for India



This symbol on the product or on its packaging indicates that this product must not be disposed of with your other household waste. Instead it is your responsibility to dispose of your waste equipment by handing it over to a designated collection point for the recycling of waste electrical and electronic equipment. The separate collection and recycling of your waste equipment at the time of disposal will help to conserve natural resources and ensure that it is recycled in a manner that protects human health and the environment. For more information about E-waste please visit <http://www.india.philips.com/about/sustainability/recycling/index.page> and to know where you can drop off your waste equipment for recycling in India please contact on below given contact details.

Helpline number: 1800-425-6396 (Monday to Saturday, 9 a.m. to 5:30 pm)

E-mail: [india.callcentre@tpv-tech.com](mailto:india.callcentre@tpv-tech.com)

## Batteries



For EU: The crossed-out wheeled bin implies that used batteries should not be put to the general household waste! There is a separate collection system for used batteries, to allow proper treatment and recycling in accordance with legislation.

Please contact your local authority for details on the collection and recycling schemes.

For Switzerland: The used battery is to be returned to the selling point.

For other non-EU countries: Please contact your local authority for correct method of disposal of the used battery.

**According to EU directive 2006/66/EC, the battery can't be disposed improperly. The battery shall be separated to collect by local service.**

	Após o uso, as pilhas e/ou baterias deverão ser entregues ao estabelecimento comercial ou rede de assistência técnica autorizada.
--	---

Information for EAC	
Month and year of manufacturing	please refer information in Rating label.
Name and location of manufacturer	ООО "Профтехника" Адрес: 3-й Проезд Марьиной роши, 40/1 офис 1. Москва, 127018, Россия
Importer and information	Наименование организации: ООО "Профтехника" Адрес: 3-й Проезд Марьиной роши, 40/1 офис 1. Москва, 127018, Россия Контактное лицо: Наталья Астафьева, +7 495 640 20 20 nat@profdisplays.ru

## Information for FAC:

"Подтверждение соответствия Мининформсвязи России: Декларация соответствия № Д-РД-4342 от 01.09.2016 года, действительна до 01.09.2024 года, зарегистрирована в Федеральном агенстве связи 14.09.2016 года"

# Table Of Contents

<b>1. Unpacking and Installation</b> .....	<b>1</b>
1.1. Transportation and Unpacking.....	1
1.2. Package Contents.....	2
1.3. Installation Notes.....	2
1.4. Installing or removing the table stand (optional) .....	3
1.5. Mounting on a Wall.....	5
1.6. Mounting in Portrait Orientation.....	7
1.7. Operating Instructions of Edge Alignment Kit.....	8
<b>2. Parts and Functions</b> .....	<b>9</b>
2.1. Control Panel.....	9
2.2. Input/Output Terminals.....	10
2.3. Remote Control.....	15
2.4. SD card Cover.....	19
<b>3. Connecting External Equipment</b> .....	<b>20</b>
3.1. Connecting External Equipment (DVD/VCR/ VCD) .....	20
3.2. Connecting a PC.....	20
3.3. Connecting Audio Equipment.....	21
3.4. Connecting Multiple Displays in a Daisy-chain Configuration.....	21
3.5. IR connection.....	22
3.6. IR Pass-through Connection.....	23
<b>4. Operation</b> .....	<b>24</b>
4.1. Watch the Connected Video Source.....	24
4.2. Change Picture Format.....	24
4.3. Overview.....	24
4.4. Media Player.....	26
4.5. Browser.....	29
4.6. PDF Player.....	32
4.7. CMND & Play.....	34
4.8. Custom App.....	34
<b>5. Setting</b> .....	<b>35</b>
5.1. Wi-Fi .....	35
5.2. Ethernet.....	35
5.3. More (available when 4G module is connected)...	35
5.4. Signage Display.....	35
5.5. Display.....	43
5.6. Apps.....	43
5.7. Security.....	43
5.8. Input method.....	43
5.9. Date & time.....	44
5.10. Developer options.....	44
5.11. About.....	44
5.12. Supplementary.....	44
<b>6. OSD Menu</b> .....	<b>47</b>
6.1. Navigating the OSD Menu.....	47
6.2. OSD Menu Overview.....	47
<b>7. Supported Media Formats</b> .....	<b>56</b>
<b>8. Input Mode</b> .....	<b>58</b>
<b>9. Pixel Defect Policy</b> .....	<b>60</b>
9.1. Pixels and Sub-Pixels.....	60
9.2. Types of Pixel Defects + Dot Definition.....	60
9.3. Bright Dot Defects.....	60
9.4. Dark Dot Defects.....	61
9.5. Proximity of Pixel Defects.....	61
9.6. Pixel Defect Tolerances.....	61
9.7. MURA.....	61
<b>10. Cleaning and Troubleshooting</b> .....	<b>62</b>
10.1. Cleaning.....	62
10.2. Troubleshooting.....	63
<b>11. Technical Specifications</b> .....	<b>65</b>

# 1. Unpacking and Installation

## 1.1. Transportation and Unpacking

### Notice for transportation

- Always keep the carton in a vertical position.  
Do NOT place the carton in any other direction.



- Do NOT place any object on the carton.



- Move the carton by stacker.



- Do NOT apply shock/vibration to the product.

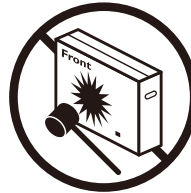

- Do NOT drop the product. Strong impacts may damage the components inside.

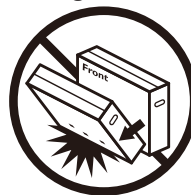

## Before installing the display

- This product is packed in a carton, together with the standard accessories.
- Any other optional accessories will be packed separately.
- Move the display by at least two (2) adults.
- After opening the carton, ensure that the contents are complete and in good condition.

## 1.2. Package Contents

Please verify that you received the following items with your package content:

- LCD display
- Quick start guide
- Remote Control and AAA batteries
- Power cord
- RS232 cable
- RS232 daisy chain cable
- Logo
- Edge Alignment Kit-1: 2PCS
- Edge Alignment Kit-2: 1PCS
- Thumb Screw: 8PCS
- SD card cover and M3 screw x1
- M2 screw x2

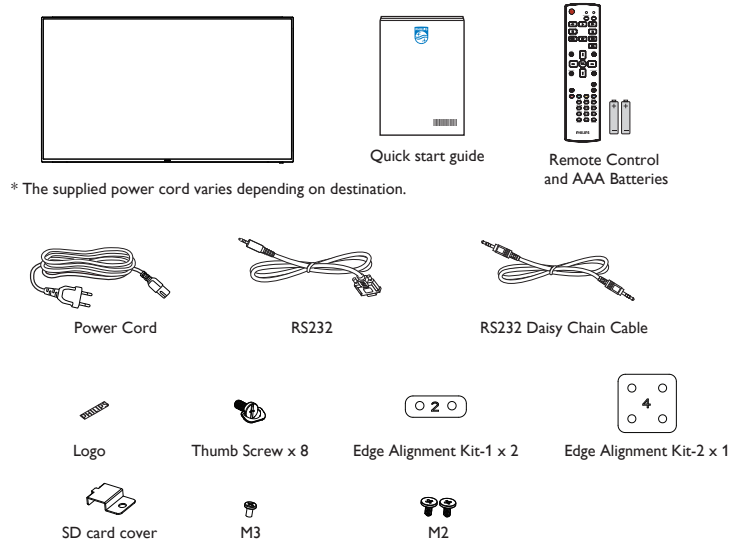

\* Items may differ in different locations

\* Display design and accessories may differ from the images shown.

### NOTES:

- For all other regions, apply a power cord that conforms to the AC voltage of the power socket and has been approved by and complies with the safety regulations of the particular country (Type H05W-F, 2G or 3G, 0.75 or 1 mm<sup>2</sup> should be used).
- Keep the packaging materials appropriately after unpacking the product.

## 1.3. Installation Notes

- Only use the power cable provided with this product. If an extension cord is required, please consult your service agent.
- The product should be installed on a flat surface, or the product may tip over: Leave a space between the rear of the product and the wall for proper ventilation. Do not install the product in a kitchen, bathroom or a place exposed to moisture, failure to do so may shorten the life of the internal parts.
- Do not install the product where it is 3000m and higher in altitude. Failure to do so may result in malfunctions.

## 1.4. Installing or removing the table stand (optional)

### Step 1- Place on the table

Take off the protective sheet which was wrapped around the display when it was packaged. Lay the protective sheet on the table, beneath the screen surface so as not to scratch the screen face.

### Step 2- Fix the tube to the display (by using M6xL41 screws)

Please refer to the following drawing to identify the position of screws.

32BDL4051D: Fasten the longest screw(M6x41.0mm) into Hole#1 and Hole#7 of tube to secure it to the display.

### Step 3- Set up the stand (using thumb screws)

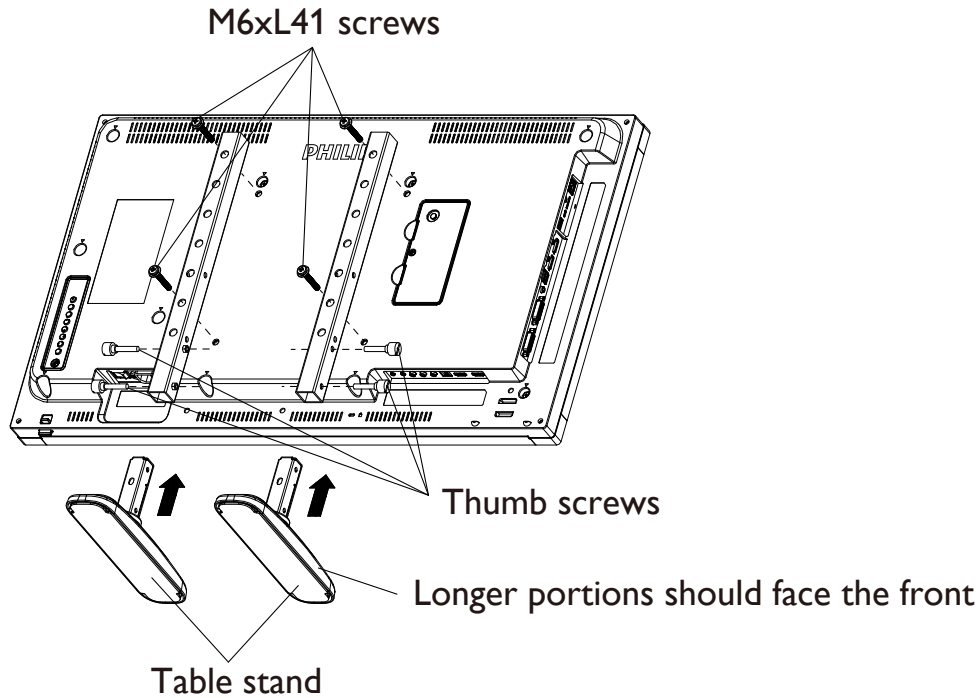

### To remove the table stands:

1. Power off the display.
2. Spread a protective sheet on a flat surface.
3. Place the display face-down on the protective sheet.
4. Remove screws using a screwdriver and place them in a safe place for reuse.



## 1.5. Mounting on a Wall

To mount this display on a wall, a standard wall-mounting kit (commercially available) is required. It is recommended that you use a mounting interface that complied with TUV-GS and /or UL1678 standard in North America.

32BDL4051D

43BDL4051D

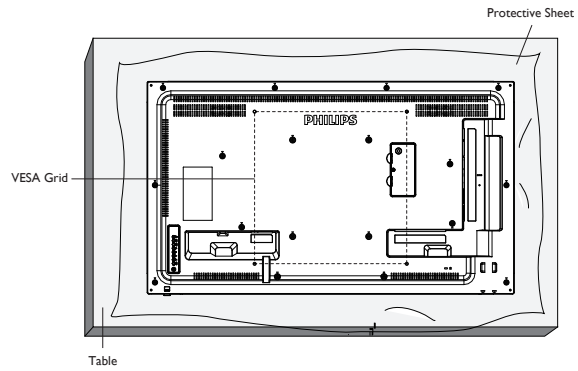
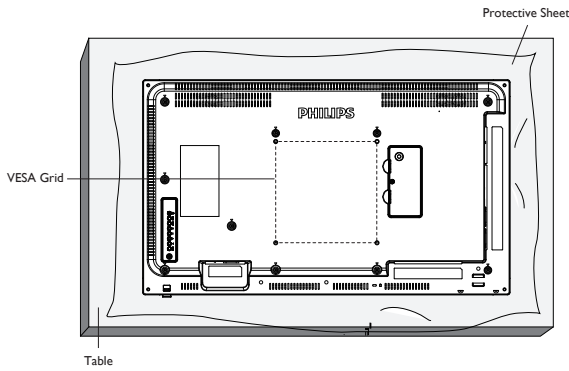

49BDL4051D

55BDL4051D

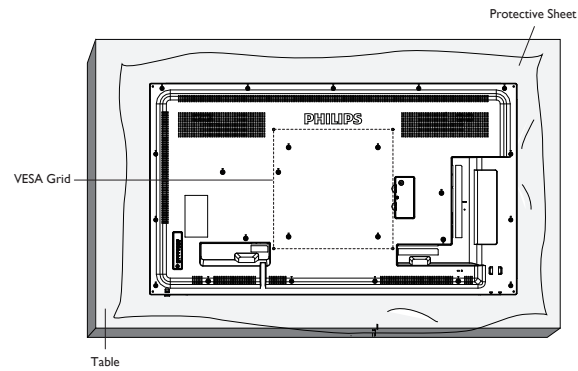
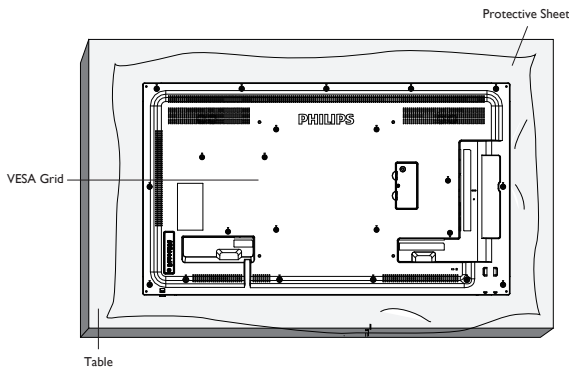

1. Prepare a flat and horizontal surface that is larger than the display and spread a thick protective sheet on it to facilitate your operation without scratching the screen.
2. Ensure you have all accessories for all types of mounting (wall mount, ceiling mount, table stand, etc).
3. Follow the instructions that came with the base mounting kit. Failure to follow the correct mounting procedures could result in damage to the equipment, or injury to the user or installer. The product warranty does not cover the damage caused by improper installation.
4. For the wall-mounting kit, use the M6 mounting screws (with a length 10 mm longer than the thickness of the mounting bracket) and tighten them securely.
5. The equipment and its associated mounting facilities still remain secure during the test. Use only the UL listed Wall Mount Bracket with a minimum weight/load of the weight of the unit without base.

### 1.5.1. VESA Grid

<b>32BDL4051D</b>	200(H) × 200(V) mm
<b>43BDL4051D</b>	400(H) × 400(V) mm
<b>49BDL4051D</b>	400(H) × 400(V) mm
<b>55BDL4051D</b>	400(H) × 400(V) mm

### 1.5.2. Weight of the unit

<b>32BDL4051D</b>	6.15 kg
<b>43BDL4051D</b>	10.4 kg
<b>49BDL4051D</b>	14.8 kg
<b>55BDL4051D</b>	18.0 kg



**Caution:**

To prevent the display from falling:

- For wall or ceiling mounting, we recommend that you install the display with metal brackets which are commercially available. For detailed instructions about the installation, refer to the guide provided with the bracket.
- To prevent the display from falling in case of earthquake or other natural disaster, please consult the manufacturer of the bracket for the mounting location.
- As this product is high and heavy, the installation of this product is recommended to be performed by four technicians.

**Ventilation Requirements for enclosure locating**

Leave a space of 100 mm at the top, rear, right and left of the display for ventilation.

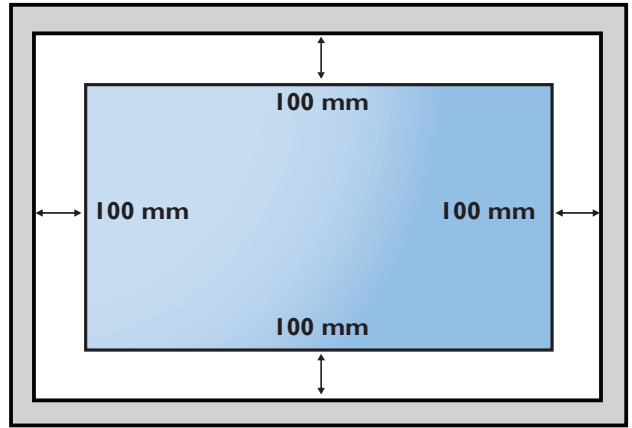

## 1.6. Mounting in Portrait Orientation

This display can be installed in portrait position.

1. If the table stand is attached, remove it first.
2. Rotate the display counter-clockwise by 90°. The "PHILIPS" logo should be on the RIGHT side when facing the display.

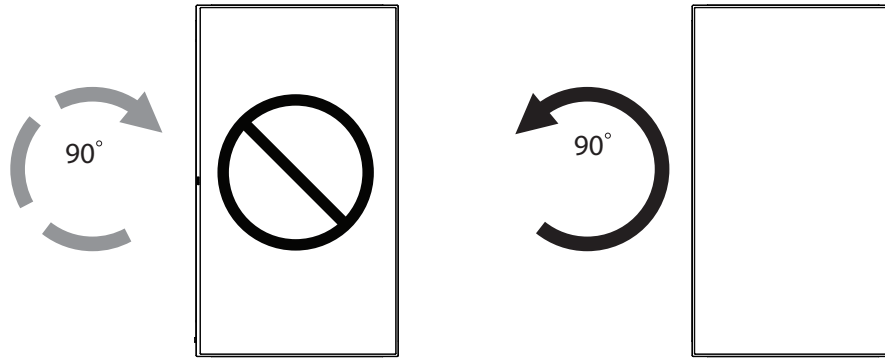

### 1.6.1. How to remove the logo

1. Prepare a piece of paper with a cutting area of logo as a protector to prevent the front bezel from scratching.
2. Use a knife and carefully remove the logo sticker with the paper placing beneath.
3. Tear off the logo sticker.

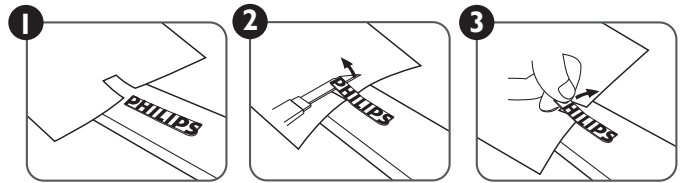

NOTE: We recommend you contact a professional technician when installing the display on a wall. We are not responsible for any damage to the product if the installation is not performed by a professional technician.

## 1.7. Operating Instructions of Edge Alignment Kit

### 1.7.1. Installing Edge Alignment Kit

- Use "Edge Alignment Kit-1" for two adjacent displays.
- Install the "Edge Alignment Kit-1" with 2 PCS of M4 screw.

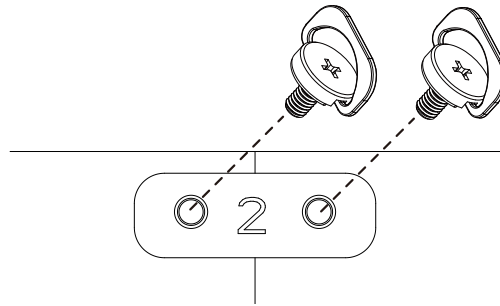

- Use "Edge Alignment Kit-2" for four adjacent displays.

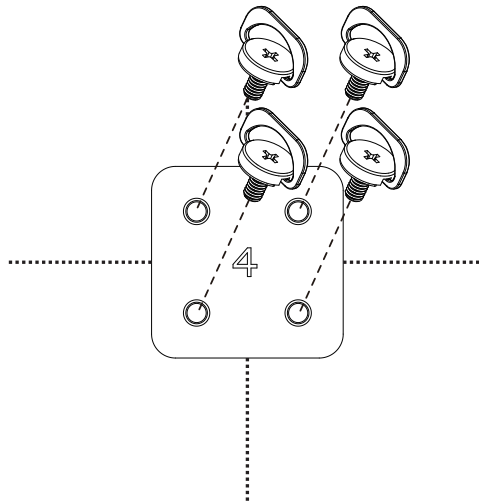

NOTE: When installing the edge alignment kit, please consult a professional technician for proper installation. We accept no liability for installations not performed by a professional technician.

## 2. Parts and Functions

### 2.1. Control Panel

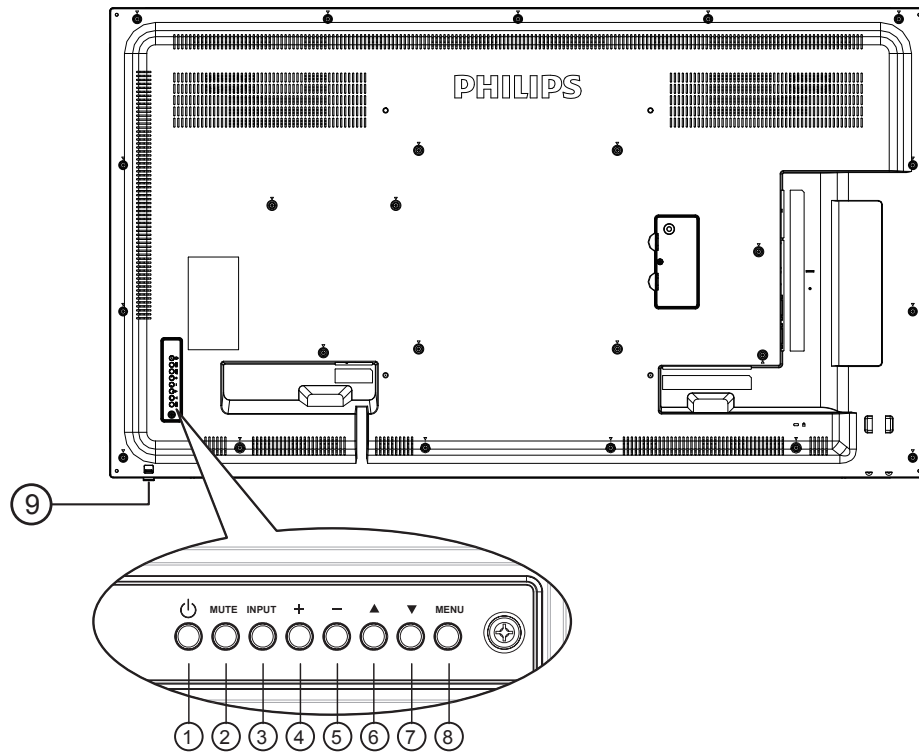

#### ① [Power] button

Use this button to turn the display on or put the display to standby mode.

#### ② [MUTE] button

Switch the audio mute ON/OFF.

#### ③ [INPUT] button

Choose the input source.

- Used as [OK] button in the On-Screen-Display menu.

#### ④ [+] button

Increase the adjustment while OSD menu is on, or increase the audio output level while OSD menu is off.

#### ⑤ [-] button

Decrease the adjustment while OSD menu is on, or decrease the audio output level while OSD menu is off.

#### ⑥ [▲] button

Move the highlight bar up to adjust the selected item while OSD menu is on.

#### ⑦ [▼] button

Move the highlight bar down to adjust the selected item while OSD menu is on.

#### ⑧ [MENU] button

Return to previous menu while OSD menu is on, or to activate the OSD menu when OSD menu is off.

#### ⑨ Remote control sensor and power status indicator

- Receives command signals from the remote control.
- Indicates the operating status of the display without OPS:
  - Lights green when the display is turned on
  - Lights red when the display is in standby mode
  - When {SCHEDULE} is enabled, the light blinks green and red
  - If the light blinks red, it indicates that a failure has been detected
  - Lights off when the main power of the display is turned off
- Pull down the lens to have better remote control performance and easy to observe the light information of power status.
- Push up the lens before mounting the display for video wall application.
- Pull/Push the lens until hearing the click sound.

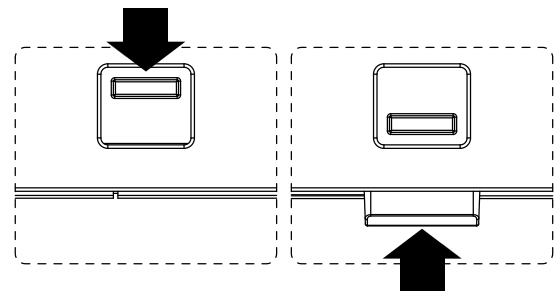

## 2.2. Input/Output Terminals

### 32BDL4051D

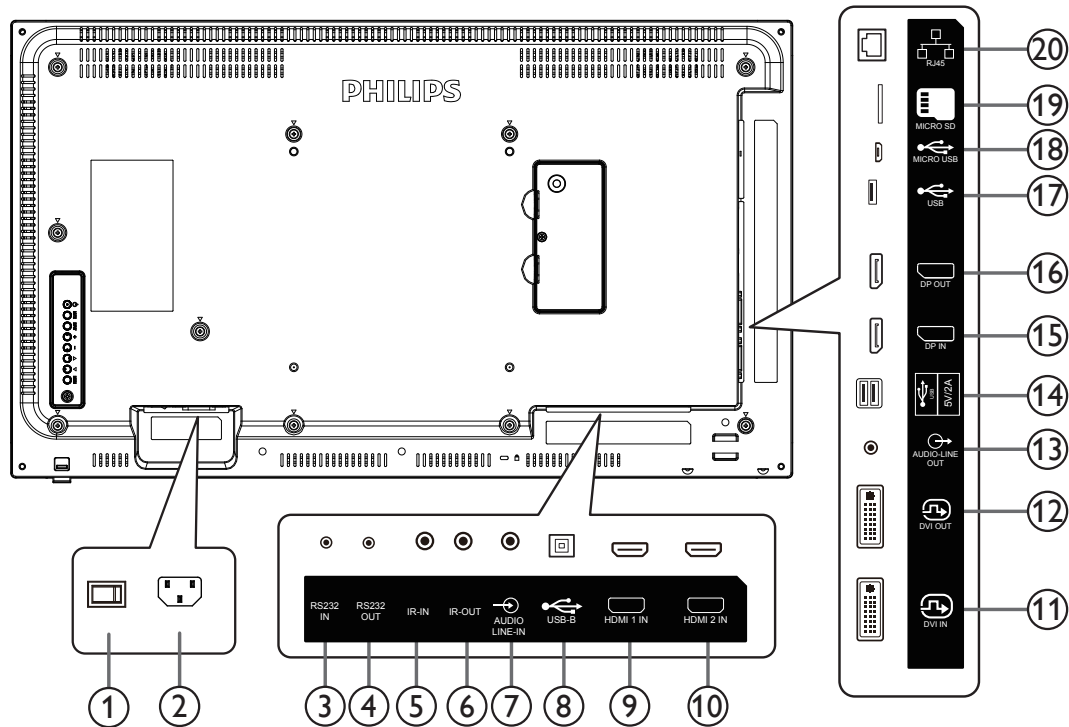

**① MAIN POWER SWITCH**

Switch the main power on/off.

**② AC IN**

AC power input from the wall outlet.

**③ RS232C IN / ④ RS232C OUT**

RS232C network input / output for the loop-through function.

**⑤ IR IN / ⑥ IR OUT**

IR signal input / output for the loop-through function.

**NOTES:**

- This display's remote control sensor will stop working if the jack [IR IN] is connected.
- To remotely control your A/V device via this display, refer to page 23 for **IR Pass Through** connection.

**⑦ AUDIO IN**

Audio input for VGA source (3.5mm stereo phone).

**⑧ USB PORT B**

Reserve for Touch model.

**⑨ HDMI 1 IN / ⑩ HDMI 2 IN**

HDMI video/audio input.

**⑪ DVI IN**

DVI-I video input.

**⑫ DVI OUT**

DVI or VGA video output.

**⑬ AUDIO OUT**

Audio output to external AV device.

**⑭ USB PORT**

Connect your USB storage device.

**⑮ DisplayPort IN / ⑯ DisplayPort OUT**

DisplayPort video input / output.

**⑰ USB PORT**

Connect your USB storage device.

**⑱ MICRO USB**

Connect your USB storage device.

**⑲ MICRO SD CARD**

Connect your MICRO SD CARD.

**⑳ RJ-45**

LAN control function for the use of remote control signal from control center for installing the optional OPS module.

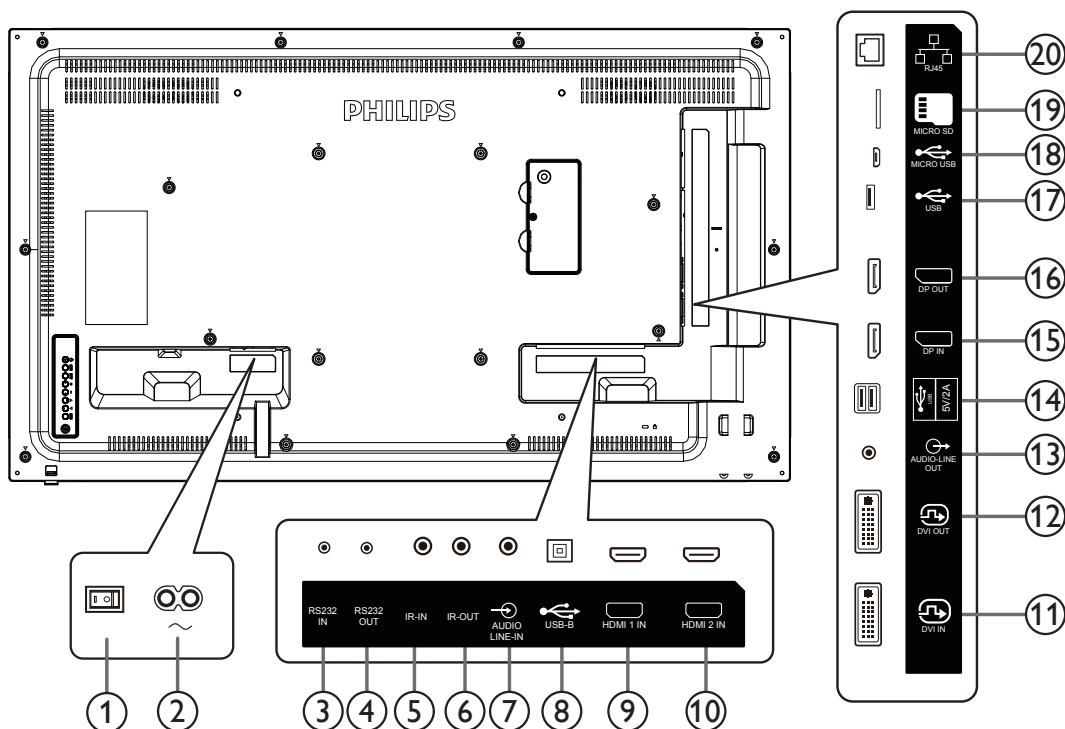

**① MAIN POWER SWITCH**

Switch the main power on/off.

**② AC IN**

AC power input from the wall outlet.

**③ RS232C IN / ④ RS232C OUT**

RS232C network input / output for the loop-through function.

**⑤ IR IN / ⑥ IR OUT**

IR signal input / output for the loop-through function.

**NOTES:**

- This display's remote control sensor will stop working if the jack [IR IN] is connected.
- To remotely control your A/V device via this display, refer to page 23 for **IR Pass Through** connection.

**⑦ AUDIO IN**

Audio input for VGA source (3.5mm stereo phone).

**⑧ USB PORT B**

Reserve for Touch model.

**⑨ HDMI 1 IN / ⑩ HDMI 2 IN**

HDMI video/audio input.

**⑪ DVI IN**

DVI-I video input.

**⑫ DVI OUT**

DVI or VGA video output.

**⑬ AUDIO OUT**

Audio output to external AV device.

**⑭ USB PORT**

Connect your USB storage device.

**⑮ DisplayPort IN / ⑯ DisplayPort OUT**

DisplayPort video input / output.

**⑰ USB PORT**

Connect your USB storage device.

**⑱ MICRO USB**

Connect your USB storage device.

**⑲ MICRO SD CARD**

Connect your MICRO SD CARD.

**⑳ RJ-45**

LAN control function for the use of remote control signal from control center for installing the optional OPS module.

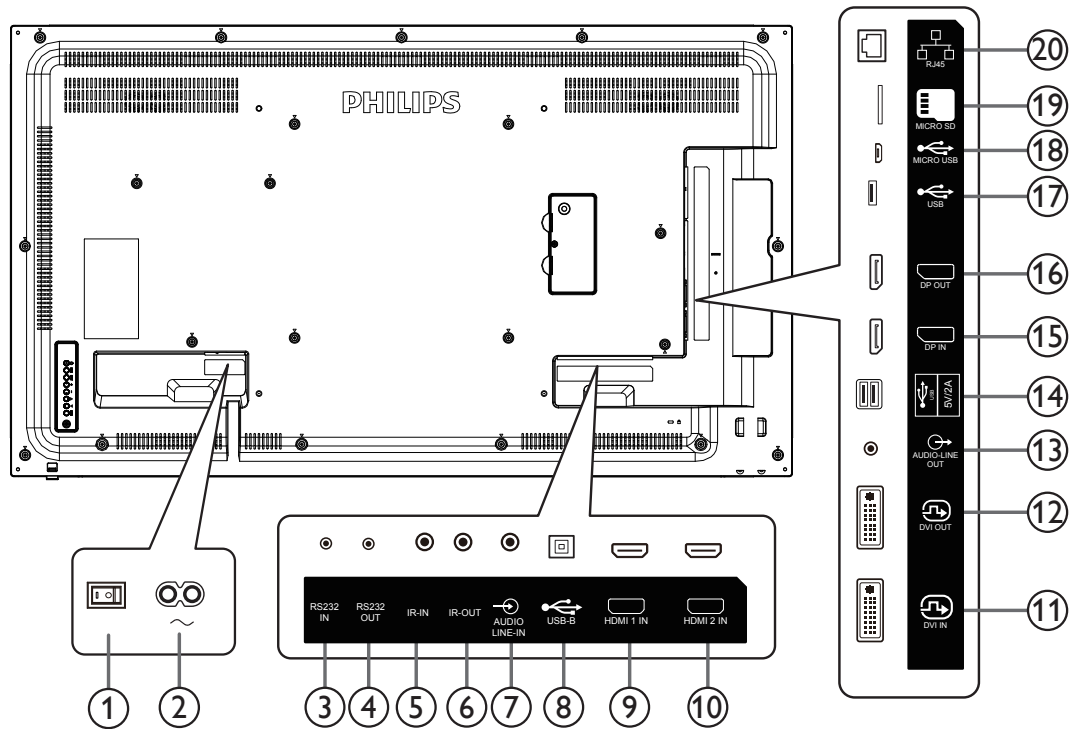

**① MAIN POWER SWITCH**

Switch the main power on/off.

**② AC IN**

AC power input from the wall outlet.

**③ RS232C IN / ④ RS232C OUT**

RS232C network input / output for the loop-through function.

**⑤ IR IN / ⑥ IR OUT**

IR signal input / output for the loop-through function.

**NOTES:**

- This display's remote control sensor will stop working if the jack [IR IN] is connected.
- To remotely control your A/V device via this display, refer to page 23 for **IR Pass Through** connection.

**⑦ AUDIO IN**

Audio input for VGA source (3.5mm stereo phone).

**⑧ USB PORT B**

Reserve for Touch model.

**⑨ HDMI 1 IN / ⑩ HDMI 2 IN**

HDMI video/audio input.

**⑪ DVI IN**

DVI-I video input.

**⑫ DVI OUT**

DVI or VGA video output.

**⑬ AUDIO OUT**

Audio output to external AV device.

**⑭ USB PORT**

Connect your USB storage device.

**⑮ DisplayPort IN / ⑯ DisplayPort OUT**

DisplayPort video input / output.

**⑰ USB PORT**

Connect your USB storage device.

**⑱ MICRO USB**

Connect your USB storage device.

**⑲ MICRO SD CARD**

Connect your MICRO SD CARD.

**⑳ RJ-45**

LAN control function for the use of remote control signal from control center for installing the optional OPS module.

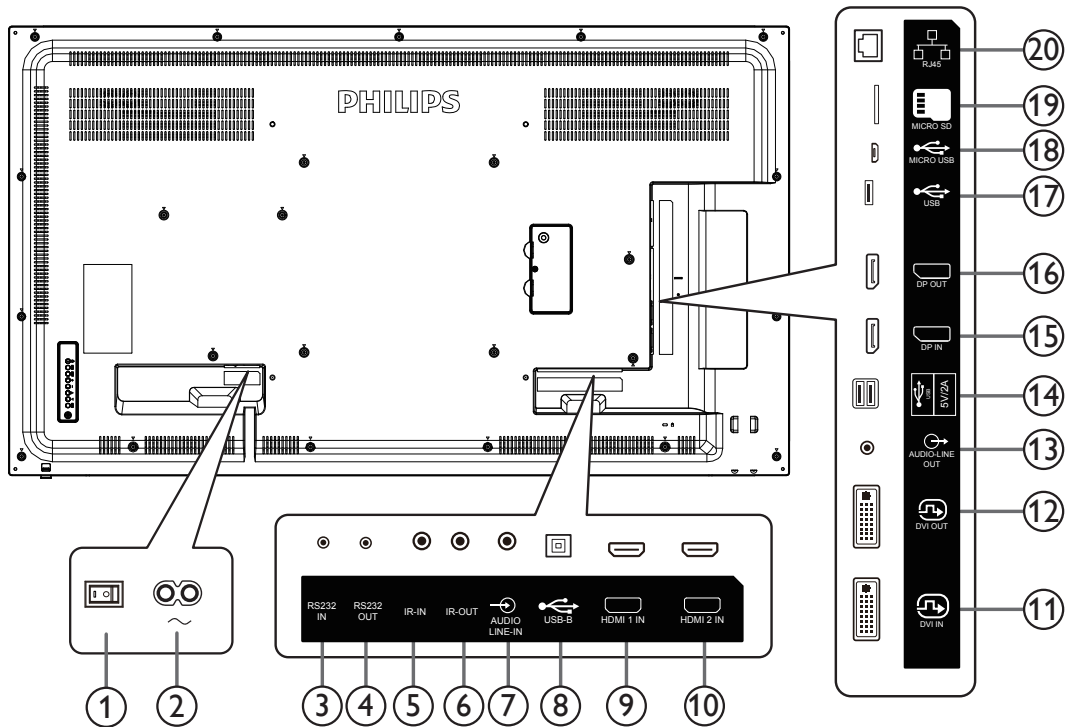

**① MAIN POWER SWITCH**

Switch the main power on/off.

**② AC IN**

AC power input from the wall outlet.

**③ RS232C IN / ④ RS232C OUT**

RS232C network input / output for the loop-through function.

**⑤ IR IN / ⑥ IR OUT**

IR signal input / output for the loop-through function.

**NOTES:**

- This display's remote control sensor will stop working if the jack [IR IN] is connected.
- To remotely control your A/V device via this display, refer to page 23 for IR Pass Through connection.

**⑦ AUDIO IN**

Audio input for VGA source (3.5mm stereo phone).

**⑧ USB PORT B**

Reserve for Touch model.

**⑨ HDMI1 IN / ⑩ HDMI2 IN**

HDMI video/audio input.

**⑪ DVI IN**

DVI-I video input.

**⑫ DVI OUT**

DVI or VGA video output.

**⑬ AUDIO OUT**

Audio output to external AV device.

**⑭ USB PORT**

Connect your USB storage device.

**⑮ DisplayPort IN / ⑯ DisplayPort OUT**

DisplayPort video input / output.

**⑰ USB PORT**

Connect your USB storage device.

**⑱ MICRO USB**

Connect your USB storage device.

**⑲ MICRO SD CARD**

Connect your MICRO SD CARD.

**⑳ RJ-45**

LAN control function for the use of remote control signal from control center for installing the optional OPS module.



### 2.2.1. Inserting the batteries in the remote control

The remote control is powered by two 1.5V AAA batteries.

To install or replace the batteries:

1. Press and then slide the cover to open it.
2. Insert the batteries with the correct polarity (+) and (-).
3. Replace the cover.

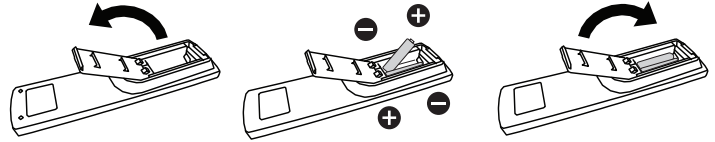

#### Caution:

Incorrect use of batteries may cause leakage or explosion. Be sure to follow the instructions below:

- Insert "AAA" batteries with the correct polarity (+ and -).
- Do not mix battery types.
- Do not use a new battery with a used one together. Otherwise, it may cause leakage or shorten the life of the batteries.
- Remove the dead batteries immediately to avoid battery leakage in the battery compartment. Do not touch exposed battery acid, as it may cause injury to your skin.
- Disposal of a battery into fire or a hot oven, or mechanically crushing or cutting of a battery, that can result in an explosion; leaving a battery in an extremely high temperature surrounding environment that can result in an explosion or the leakage of flammable liquid or gas; and a battery subjected to extremely low air pressure that may result in an explosion or the leakage of flammable liquid or gas.

NOTE: Remove the batteries from the battery compartment when not using for an extended period of time.

### 2.2.2. Handling the remote control

- Do not drop or apply shock to the remote control.
- Do not allow any liquid to get inside the remote control. If water has entered the remote control, wipe the remote control with a dry cloth immediately.
- Do not place the remote control near heat and steam sources.
- Do not attempt to disassemble the remote control, unless you need to place batteries in the remote control.

### 2.2.3. Operating range of the remote control

Point the top front of the remote control at the remote sensor on the display when you press the buttons.

Use the remote control within a distance of less than 5m/16ft from the display's sensor; and a horizontal and vertical angle of less than 30°.

NOTE:

1. The remote control may not function properly when the remote control sensor on the display is under direct sunlight or strong illumination, or when there is an object between the remote control and the remote sensor of the display.
2. Push out the lens to have better remote control performance and easy to observe the light information of power status.
3. Pull back the lens before mounting the display for video wall application.
4. Pull/Push the lens until hearing the click sound.

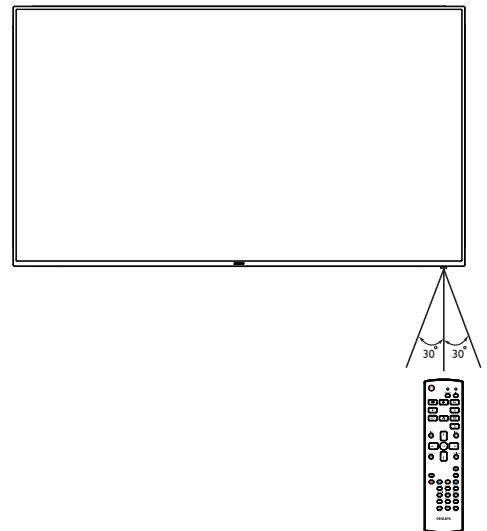

## 2.3. Remote Control

### 2.3.1. General functions

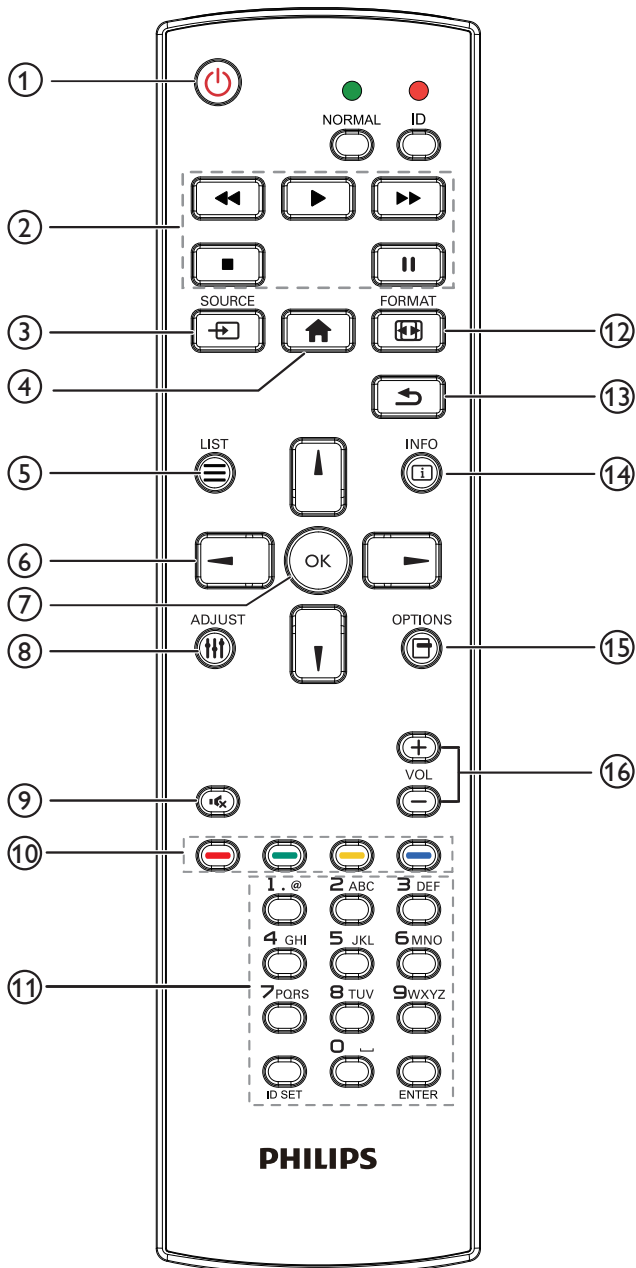

① **[POWER] POWER button**

Turn the power On/Off.

② **[PLAY] buttons**

Control playback of media files.(for Media Input only)

**Freeze feature**

**Pause:** hot key for freezing all inputs content.

**Play:** hot key for unfreezing all input content.

③ **[SOURCE] SOURCE button**

**Root Menu:** Go to the OSD of Video source.

④ **[HOME] HOME button**

**Root Menu:** Go to the OSD of Main Menu.

**Others:** Exit from the OSD.

⑤ **[LIST] LIST button**

Reserved.

⑥ **NAVIGATION buttons**



**Root Menu:** Go to the OSD of Smart picture.

**Main Menu:** Move the selected item up to make adjustment.

**IR Daisy Chain Menu:** Increase the controlled Group ID number.



**Root Menu:** Go to the OSD of Audio source.

**Main Menu:** Move the selected item bar down to make adjustment.

**IR Daisy Chain Menu:** Decrease the controlled Group ID number.



**Main Menu:** Go to the previous level of menu.

**Source Menu:** Exit from the source menu.

**Volume Menu:** Decrease the volume.



**Main Menu:** Go to the next level of menu or set selected option.

**Source Menu:** Go to the selected source.

**Volume Menu:** Increase the volume.

⑦ **[OK] OK button**

**Root Menu:** Go to the OSD of IR daisy chain in Primary/Secondary mode.

**Main Menu:** Confirm an entry or selection.

⑧ **[ADJUST] ADJUST button**

Go to the OSD of Auto Adjust (forVGA only).

⑨ **[MUTE] MUTE button**

Sound mute on or off.

⑩ **[COLOR] COLOR buttons**

Choose a task or option. (for Media Input only)

[GREEN] Hot key for Window selection function.

⑪ **[Number/ ID SET/ ENTER] button**

Enter text for network setting.

Press to set the display ID. Refer to **2.3.2. ID Remote Control** for more details.

⑫ **[FORMAT] FORMAT button**

Change Image Zoom Mode [Full][4:3][1:1][16:9][21:9][Custom].

⑬ **[BACK] BACK button**

Return to the previous page or exit from the previous function.

⑭ **[INFO] INFO button**

Show Information OSD.

⑮ **[OPTIONS] OPTIONS button**

Reserved.

⑯ **[VOLUME] VOLUME button**

Adjust volume level.

### 2.3.2. ID Remote Control

Set remote control ID number when using several displays.

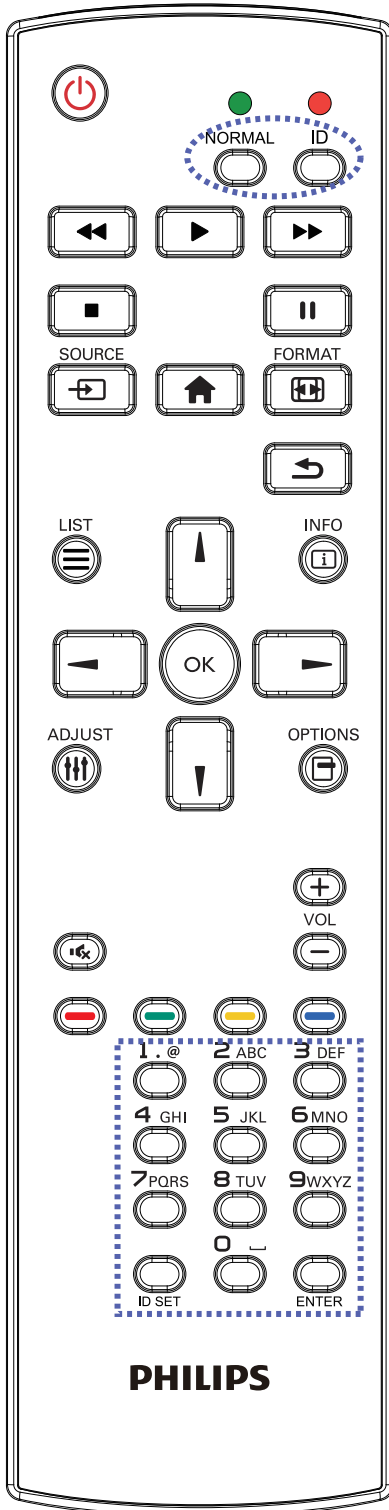

Press the [ID] button and the red LED blinks twice.

1. Press [ID SET] button for more than 1 second to enter the ID Mode. The red LED lights up.  
Press the [ID SET] button again will exit the ID Mode. The red LED lights off.

Press the digit numbers [0] ~ [9] to select the display to be controlled. For example: press [0] and [1] for display No.1, press [1] and [1] for display No.11.

The numbers available are [01] ~ [255].

2. If no button is pressed within 10 seconds, it will exit from the ID mode.
3. If a wrong button is pressed, wait for 1 second until the red LED lights off and then turns on again, then press the correct digits.
4. Press [ENTER] button to confirm your selection. The red LED blinks twice and then lights off.

#### NOTE:

- Press [NORMAL] button. The green LED blinks twice, indicating that the display is under normal operation.
- It is necessary to set up the ID number for each display before selecting its ID number.

### 2.3.3. Remote Control buttons on Android source

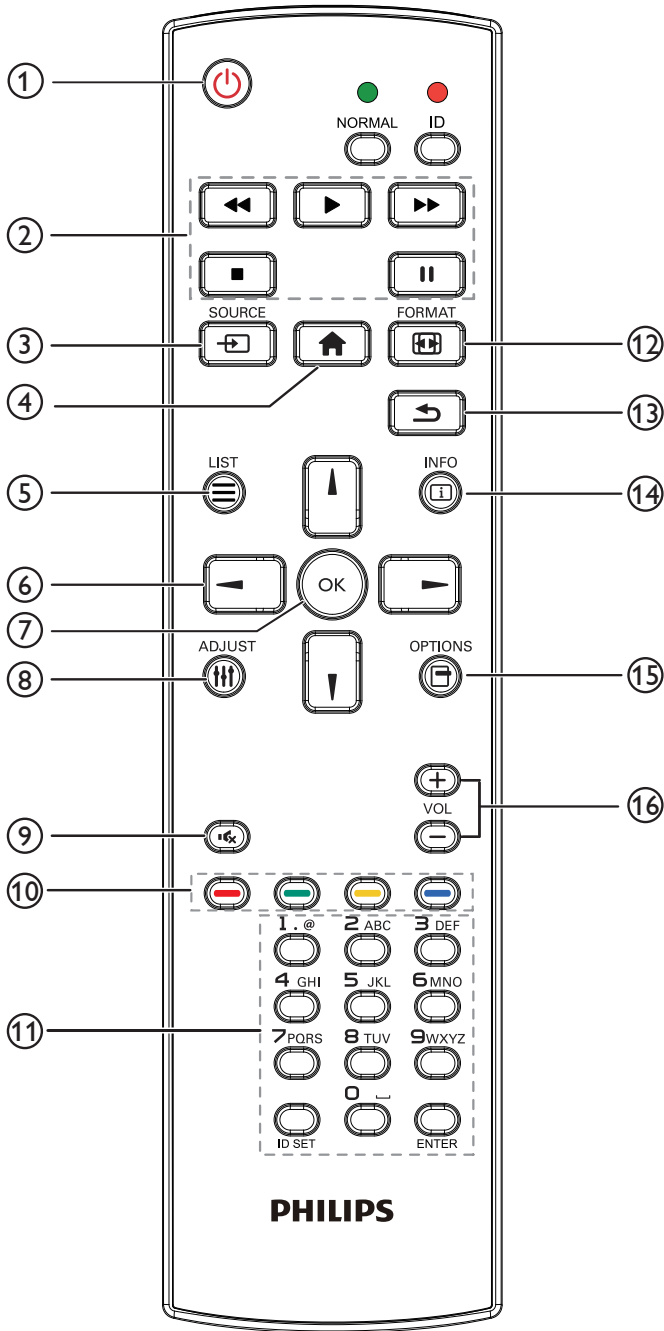

#### ① [POWER] POWER button

Turn the display On or turn the the display to standby mode.  
The button is only controlled by Scalar.

#### ② [PLAY] buttons

1. Control playback of media (video/audio/picture) files.  
There are 4 ways to play the media files.

- 1) File Manager  
Find the media file from the File Manager and select it to play.
- 2) Media Player -> Compose -> edit or new add playlist -> choose any media files -> press button to play the media file directly.

3)Media Player -> Play -> choose non-empty play list -> press to play all media files from the playlist.

4) Set media playlist in Boot on Source or Schedule by OSD menu.

2. Play the PDF file

There are 3 ways to play the PDF files.

1) File Manager

Find the PDF file from the File Manager and select it to play.

2) PDF Player -> Play -> choose non-empty play list -> press to play all PDF files from the playlist.

3) Set pdf playlist in Boot on Source or Schedule by OSD menu.

3. When playing a PDF, video or music file, you can press button to stop playing. If you press again, playback will be started from the beginning of the file.

4. When playing a PDF, video or music file, you can press button to pause playing.

5. All media or PDF files should be located in the folder of "philips", under the root directory of the specified storage (internal/USB/SD Card). All sub-folders (video/photo/music/pdf) are named by media types and shouldn't be changed.

**videos:** {root dir of storage}/philips/video/

**photos:** {root dir of storage}/philips/photo/

**music :** {root dir of storage}/philips/music/

**pdfs :** {root dir of storage}/philips/pdf/

Note that the root directories of three storages are

**Internal storage:** /sdcard

**USB storage:** /mnt/usb\_storage

**SD card :** /mnt/external\_sd

#### ③ [] SOURCE button

Select an input source.

The button is only controlled by Scalar.

#### ④ [] HOME button

Access the OSD menu.

The button is only controlled by Scalar.

#### ⑤ [] LIST button

1. In the content of the web page, move the focus up to the next selectable items.

2. Move the focus up to the next control or widget such as buttons.

#### ⑥ [NAVIGATION] buttons

1. Navigate through the menus and select an item.

2. In the content of the web page, these buttons are for controlling

the scroll bar of the screen. Press or for moving the

vertical scroll bar up or down. Press or for moving the horizontal scroll bar left or right.

3. For PDF files,

» when zoom in/out is performed,

Press , , or to adjust the position of the screen.

» when zoom in/out is not performed,

Press  to go to the next page.

Press  to go to the previous page.

### ⑦ [OK] button

Confirm an entry or selection.

### ⑧ [⇓] ADJUST button

1. In the content of the web page, move the focus down to the next selectable items.
2. Move the focus down to the next control or widget such as buttons.

### ⑨ [🔇] MUTE button

Sound mute on or off.

The button is only controlled by Scalar.

### ⑩ [🔴] [🟢] [🟡] [🟠] COLOR buttons



1. For PDF files,

press  button to perform zoom-in;

press  button to perform zoom-out.

After zoom-in or zoom-out, press  button to revert the PDF file to the original size.

### ⑪ [Number/ ID SET/ ENTER] button

1. ID SET  and ENTER  have no function on Android source. These buttons are only controlled by Scalar.
2. For PDF file, enter the page number by pressing number buttons and then press  button to enter the specified page.

### ⑫ [🖼️] FORMAT button

Change picture format. The button is only controlled by Scalar.

### ⑬ [↶] BACK button



Return to the previous page or exit from the previous function.

### ⑭ [i] INFO button

1. Display information about the current input signal. It is shown by Scalar.
2. Media Player -> Compose -> edit or add a new playlist -> choose any media files -> press  to show the information of the selected media file.

### ⑮ [☰] OPTIONS button

Open the toolbox from Media Player or PDF Player:

1. Media Player -> Compose -> Edit or add a new playlist -> press  to open a toolbox. The toolbox will slide from the left side of the screen.
2. PDF Player -> Compose -> Edit or add a new playlist -> press  to open a toolbox. The toolbox will slide from the left side of the screen.

### ⑯ [−] [+] VOLUME button

Adjust volume level. The buttons are only controlled by Scalar.

## 2.4. SD card Cover

- Use the SD card cover and screws to cover the Micro SD card.

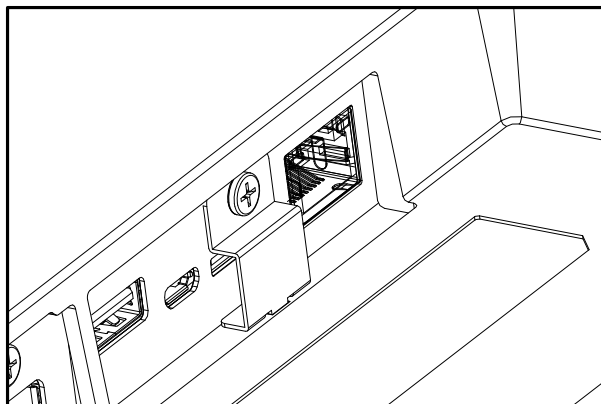
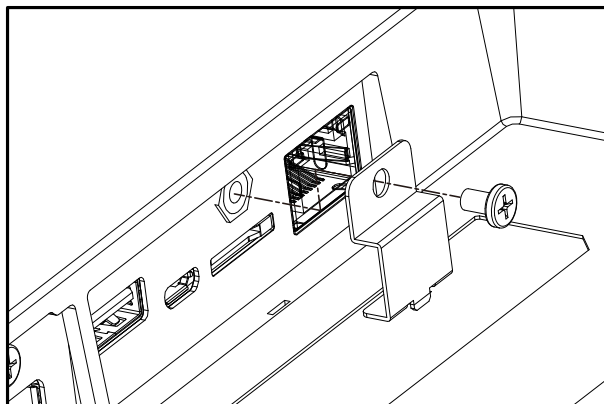

### 3. Connecting External Equipment

#### 3.1. Connecting External Equipment (DVD/VCR/VCD)

##### 3.1.1. Using HDMI video input

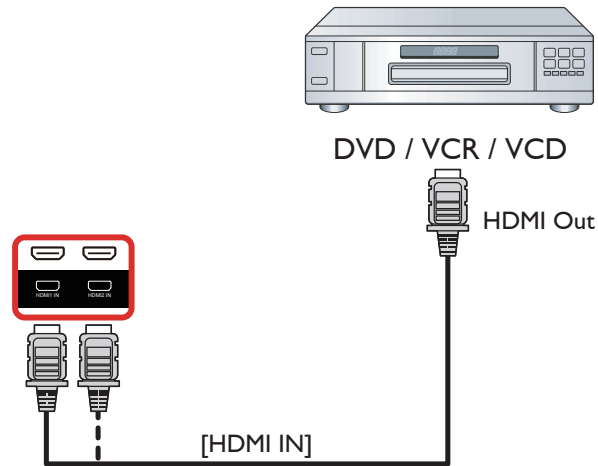

#### 3.2. Connecting a PC

##### 3.2.1. Using DVI input

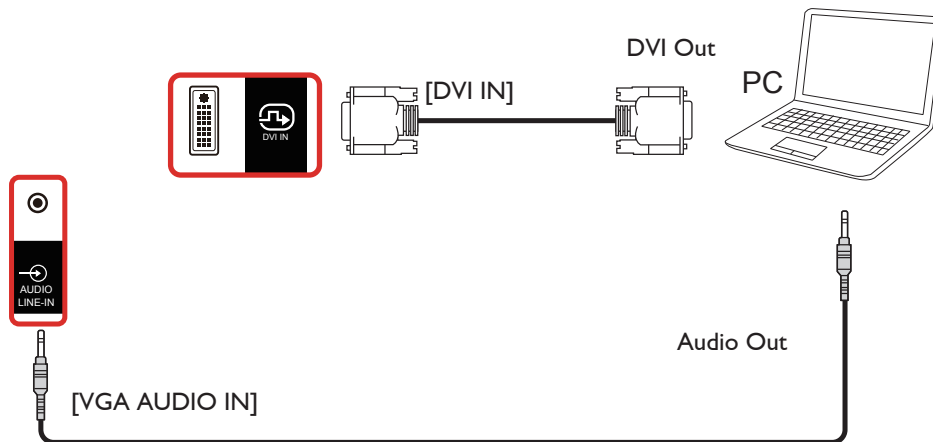

##### 3.2.2. Using HDMI input

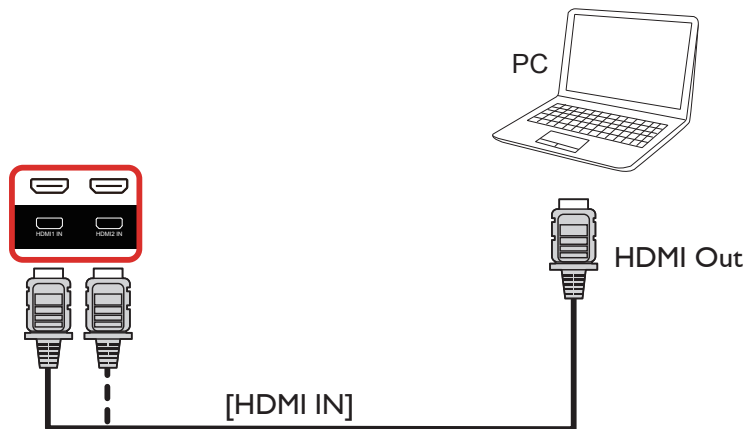

### 3.2.3. Using DisplayPort input

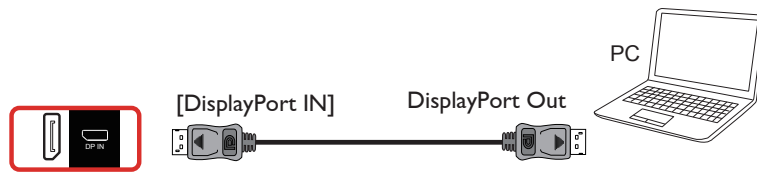

## 3.3. Connecting Audio Equipment

### 3.3.1. Connecting an external audio device

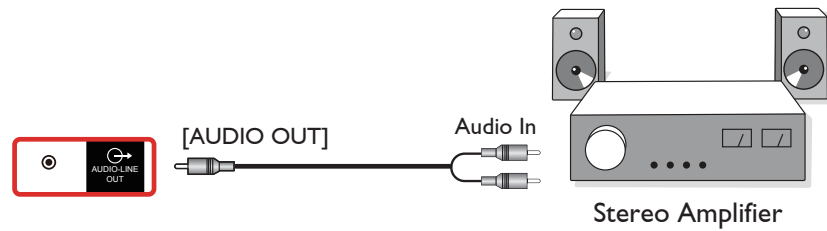

## 3.4. Connecting Multiple Displays in a Daisy-chain Configuration

You can interconnect multiple displays to create a daisy-chain configuration for applications such as a menu board.

### 3.4.1. Display control connection

Connect the [RS232 OUT] connector of DISPLAY 1 to the [RS232 IN] connector of DISPLAY 2.

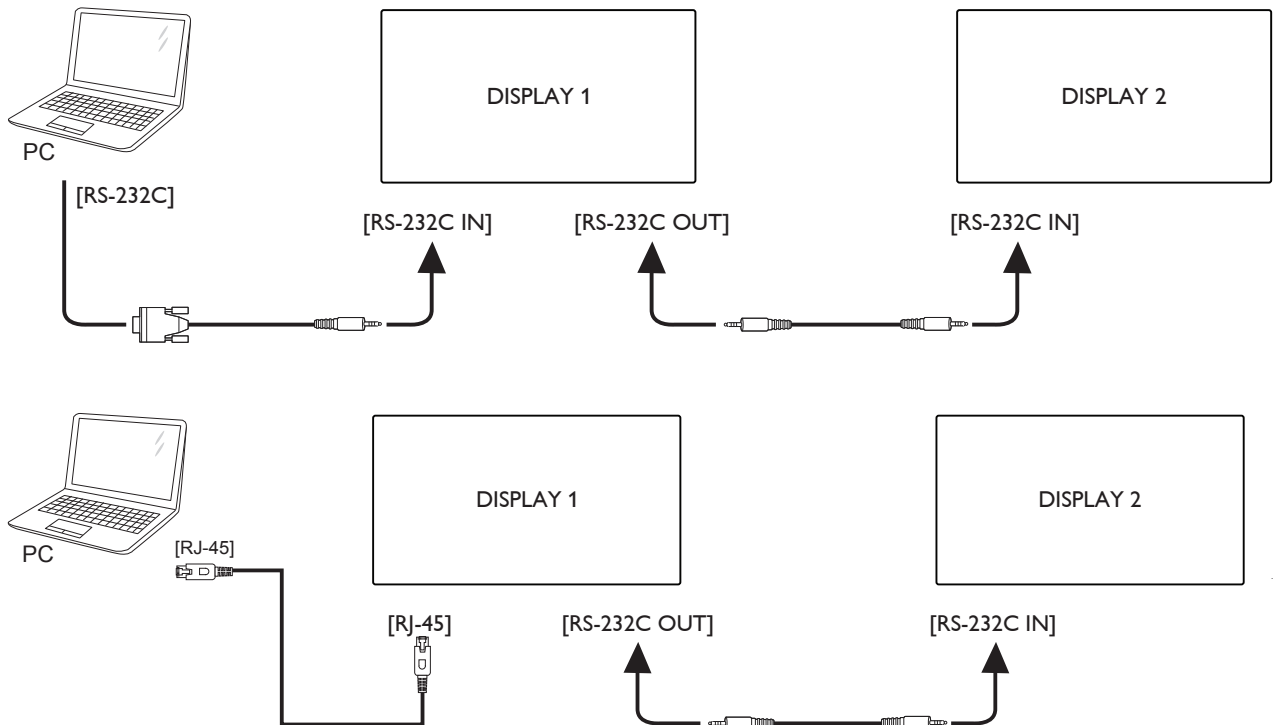



### 3.4.2. Digital video connection

Connect the [DP OUT] connector of DISPLAY 1 to the [DP IN] connector of DISPLAY 2.

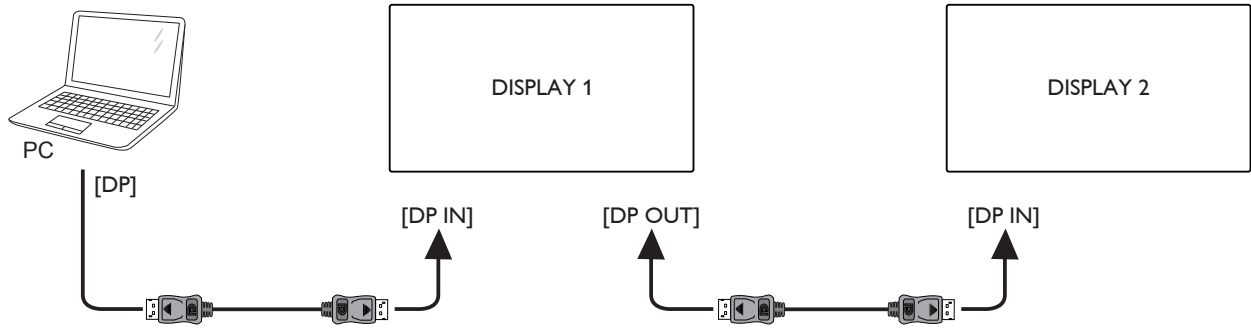

Connect the [DVI OUT] connector of DISPLAY 1 to the [DVI IN] connector of DISPLAY 2.

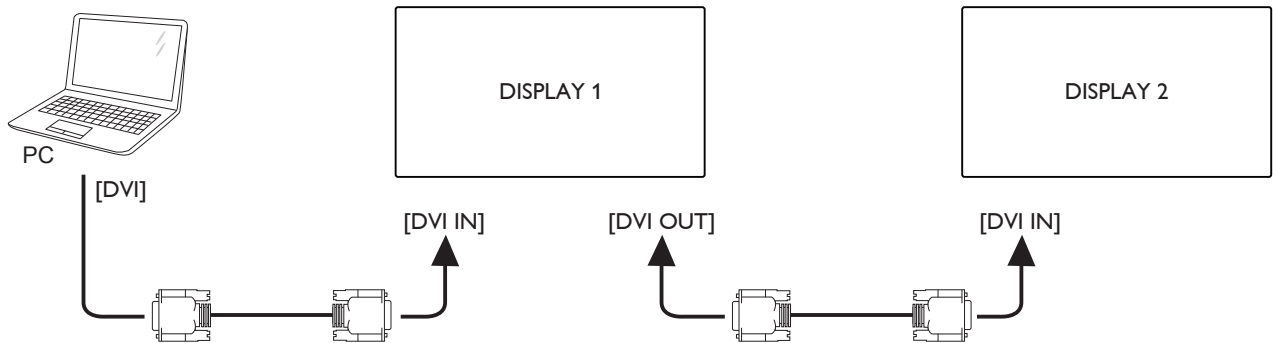

### 3.5. IR connection

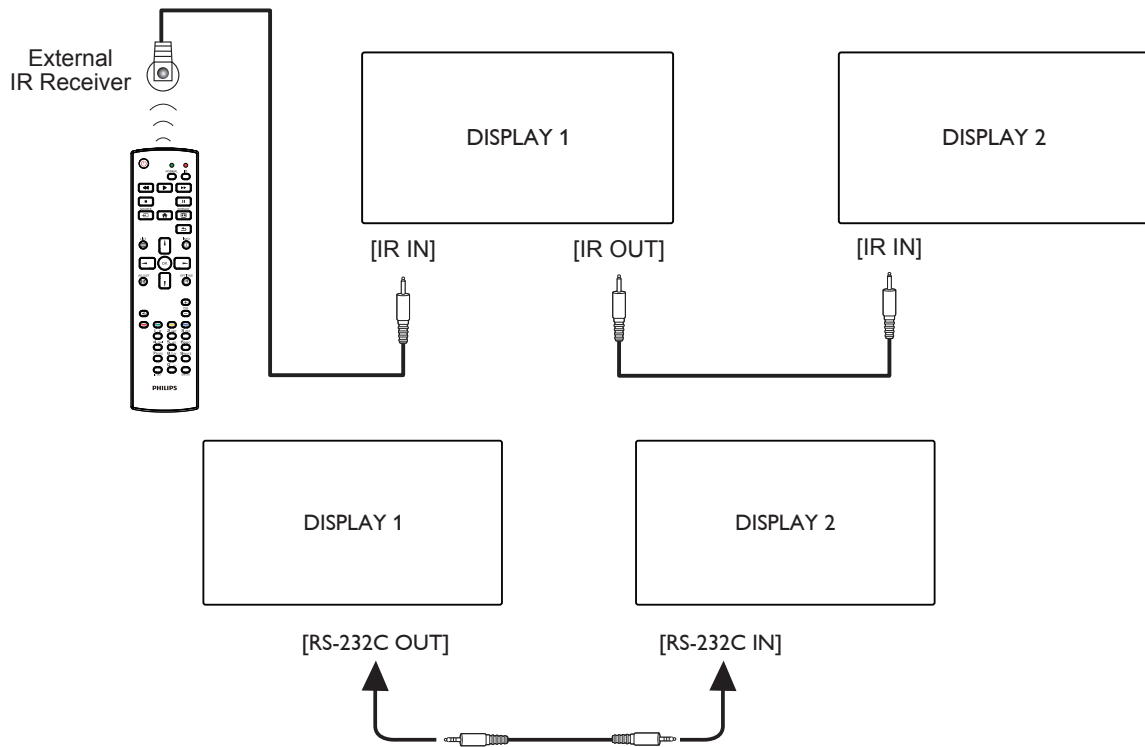

NOTE:

1. The remote control sensor of this display will stop working if the [IR IN] is connected.
2. IR loop through connection can support up to 9 displays.
3. IR in daisy chain via RS232 connection can support up to 9 displays.

### 3.6. IR Pass-through Connection

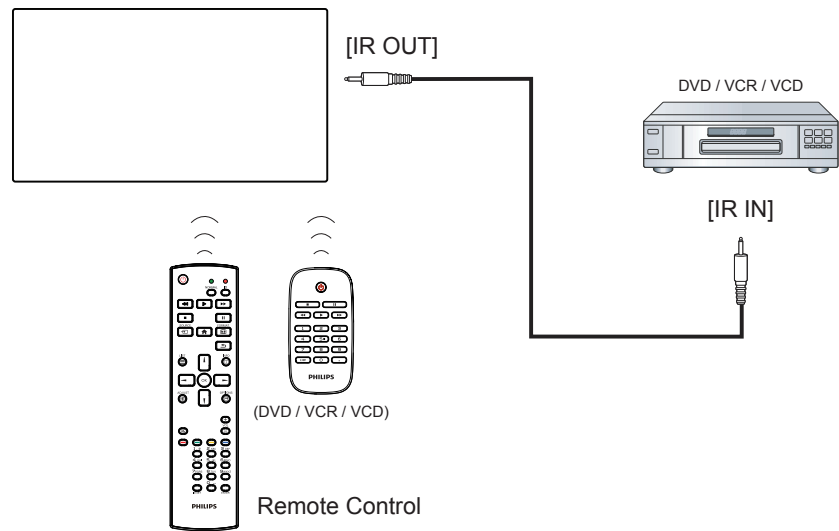

## 4. Operation

**NOTE:** The control button described in this section is mainly on the remote control unless specified otherwise.

### 4.1. Watch the Connected Video Source

1. Press the **[SOURCE]** button.
2. Press **[M]** or **[T]** button to select a device, then press **[OK]** button.

### 4.2. Change Picture Format

You can change the picture format to suit the video source. Each video source has its available picture formats.

The available picture formats depend on the video source:

1. Press **[FORMAT]** button to select a picture format.
  - PC mode: {Full} / {4:3} / {Real} / {21:9} / {Custom}.
  - Video mode: {Full} / {4:3} / {Real} / {21:9} / {Custom}.

### 4.3. Overview

1. Android PD launcher:
  - Android PD launcher is a black page as shown below:

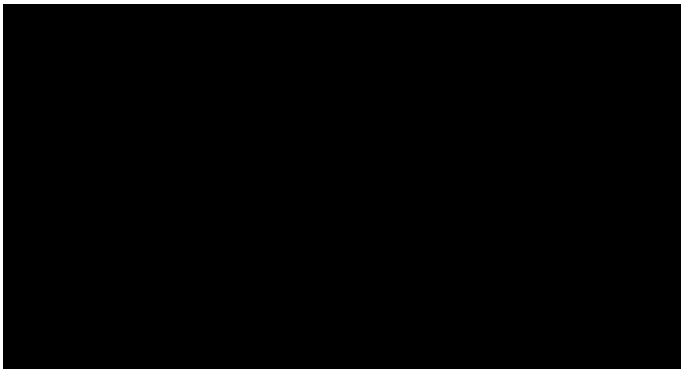

- Exit the App by pressing the “Back” key and the screen will enter Android PD launcher.
- When you return to Android PD launcher; a hint image will be prompted on the screen for 5 seconds.
- The hint image notifies you that you can press source key to change source.



2. Admin mode:
  - Press “Home + 1888” to enter the Admin mode. Please make sure that you see the Home OSD menu after “Home” is pressed, and then press 1888 in sequence. Two continuous “Home” keys will not be a valid hotkey.
  - The Admin mode consists of the following Apps: “Settings”, “Apps”, “Network”, “Storage” and “Help”.

- When leaving from the Admin mode, the system will return to last source.

Home page of Admin mode, this page consists of the following items: “Settings”, “Apps”, “Network”, “Storage” and “Help”.

Settings: go to Settings page.

Applications: show all apps.

Network: set Wi-Fi, Ethernet and Mobile network (optional).

Storage: go to Storage page.

Help: display QR code.

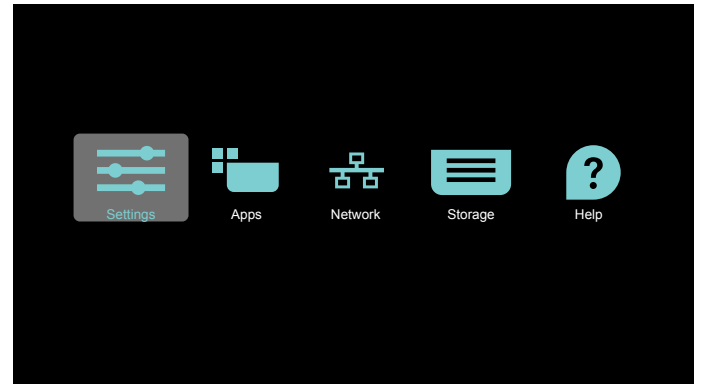

1) Settings page:

Settings: go to Settings page.

Signage Display: go to signage display settings page.

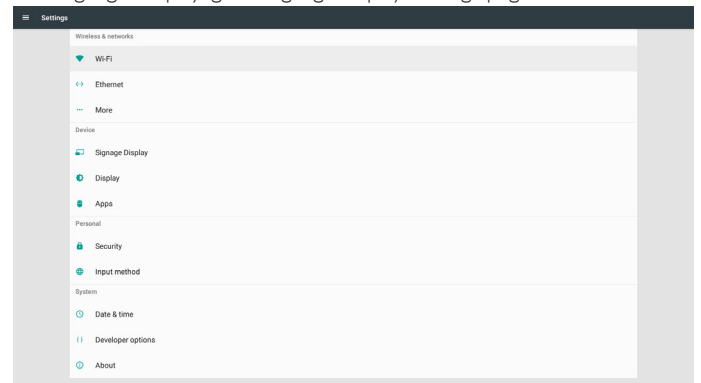

2.) Application page:

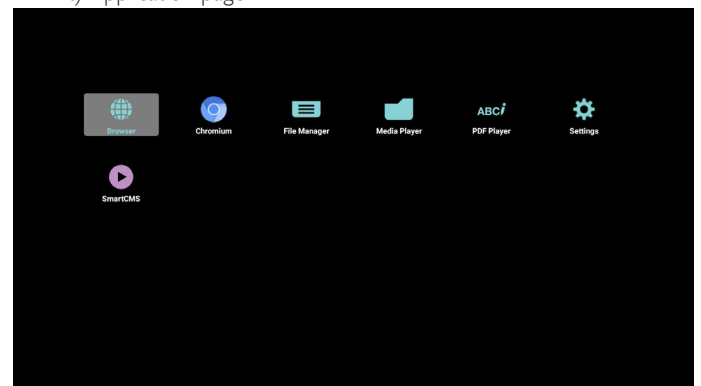

3) Network page

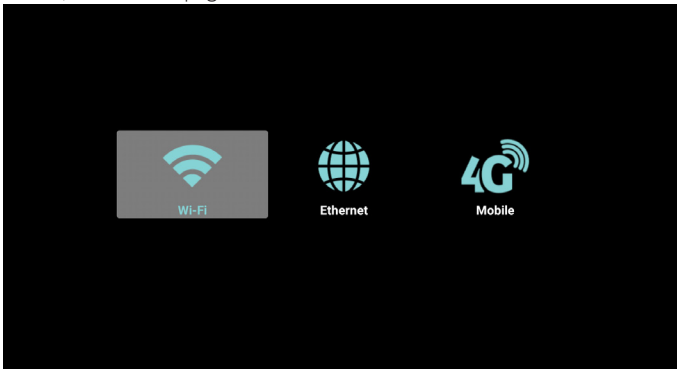

4) Storage page

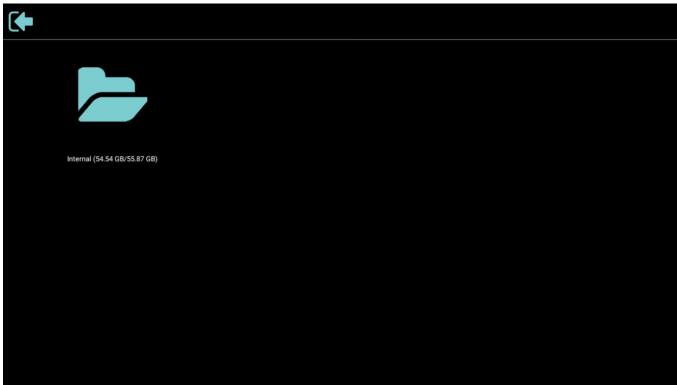

5) Help page

Display QR to link to Philips support website.



## 4.4. Media Player

### 4.4.1. OSD menu interaction with media player:

1. Boot on source:
  - Input:
    - If you select Media player as the source, the system will enter media player automatically after the boot process is completed.
  - Playlist:
    - 0: go to the main page of media player:
    - 1 - 7: go to media player and playback File1 - File7 of playlist automatically.
2. Schedule:
  - Today:
    - Show date and time.
  - 1 - 7:
    - Set up to 7 schedules.
  - On/Off:
    - Set start time and end time.
  - Input:
    - Select Media player as the source, the PD will launch the media player automatically at end time.
  - MON,TUE,WED,THU, FRI, SAT,SUN, Every week :
    - Set life cycle.
  - Play list :
    - 0: go to the main page of media player:
    - 1 - 7: go to media player and playback File1 - File7 of the playlist automatically.
  - Clear all

### 4.4.2. Media Player introduction:

1. The main page of Media Player, this page consists of three options: "Play", "Compose" and "Settings".
  - Play: select a playlist to play.
  - Compose: edit a playlist.
  - Settings: setting the properties of Media Player.

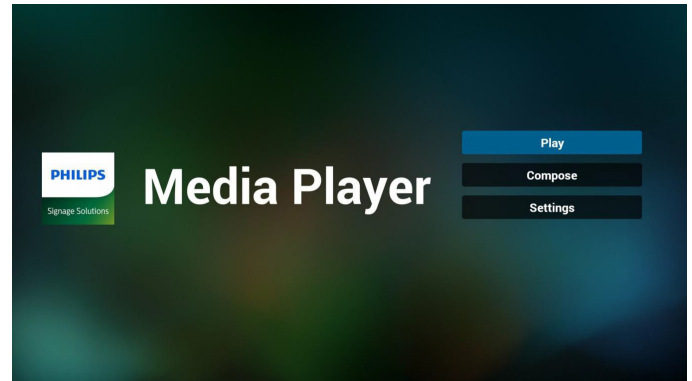

2. Select "Play" on the main page, first you should choose one playlist to play between FILE 1 and FILE 7. The pencil icon means that the playlist contains the content.

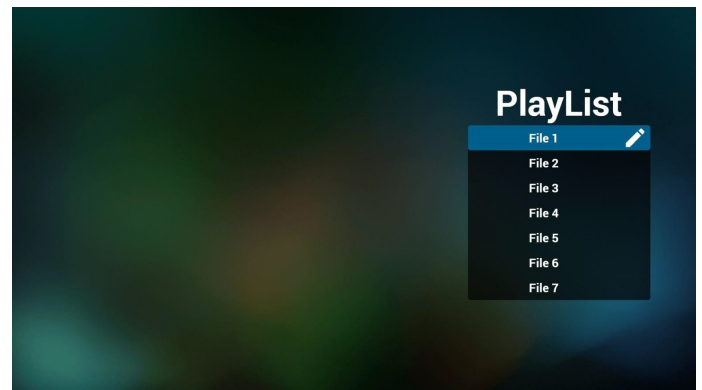

3. Select "Compose" on the main page, first you should select one playlist to edit between FILE 1 and FILE 7. The pencil icon means that the playlist contains the content.

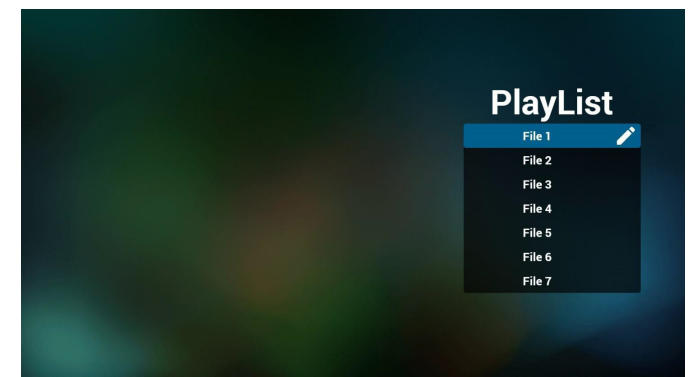

4. If an empty playlist is selected, the App will guide you through selecting the media source.
  - All media files should be stored in /philips/ of root directory.
  - For example,
    - videos: {root dir of storage}/philips/video/**
    - photos: {root dir of storage}/philips/photo/**
    - music : {root dir of storage}/philips/music/**

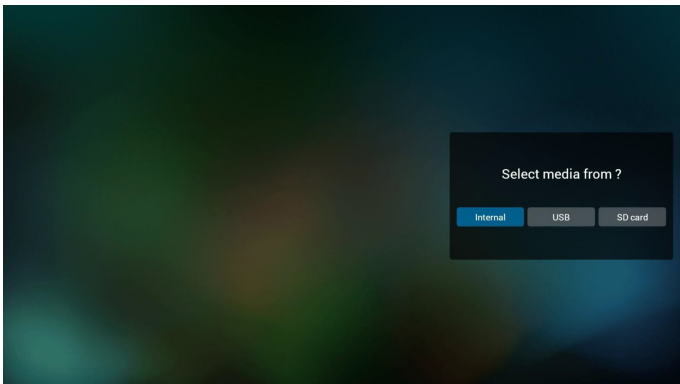

5. To edit or delete a non-empty playlist, select the desired playlist that has a pencil icon on right side of the file.

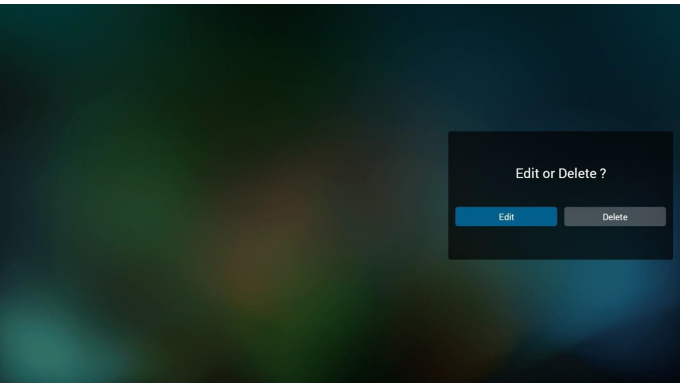

6. Once you start to edit a playlist, a menu is displayed as below.  
 Source - files saved in the memory storage.  
 Playlist – files saved in the playlist.  
 The following functions can be operated through the corresponding keys on the remote control.  
**Option key** – launch the side menu bar  
**Play key** – play the media file.  
**Info key** – show the media info.  
**Ok key** – select/deselect a file.

From the side menu bar, the following functions are available:

- **Select all:** select all files saved in the storage.
- **Delete all:** delete all playlist files.
- **Add/Remove:** add or remove a playlist from source.
- **Sort:** sort the playlist.
- **Save/abort:** save or abort the playlist.
- **Back:** return to the previous menu.

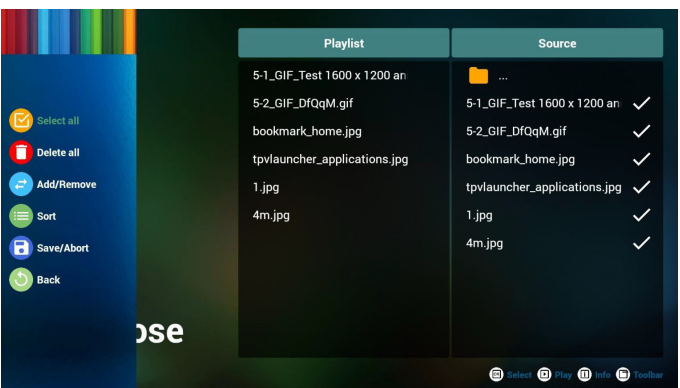

7. If “Sort” is selected, you can customize the file order severally.

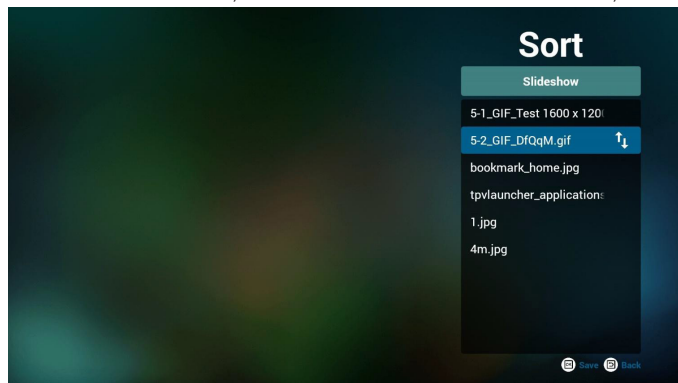

8. After selecting the desired file, press “Info” key to obtain the detailed information.



9. After selecting the desired file, press “Play” key to play the media file immediately.



10. If you create a playlist with all image files, you will be asked to add a background music to the slideshow before saving.

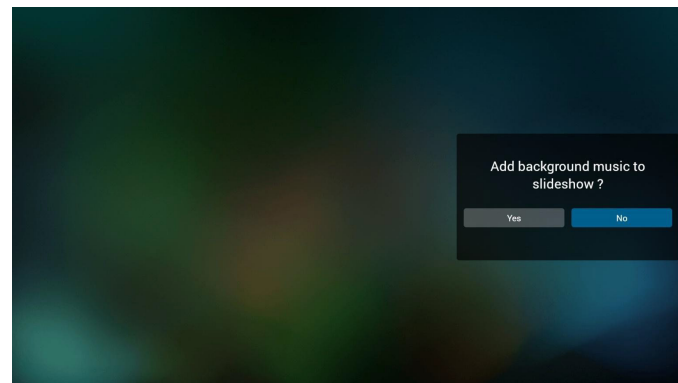

11. Select "Settings" on the main page, there are 3 options available: "Repeat Mode", "Slideshow Effect" and "Effect Duration".

**Repeat Mode:** set the repeat mode.

**Slideshow Effect:** photo slideshow effect.

**Effect Duration:** duration of photo effect.

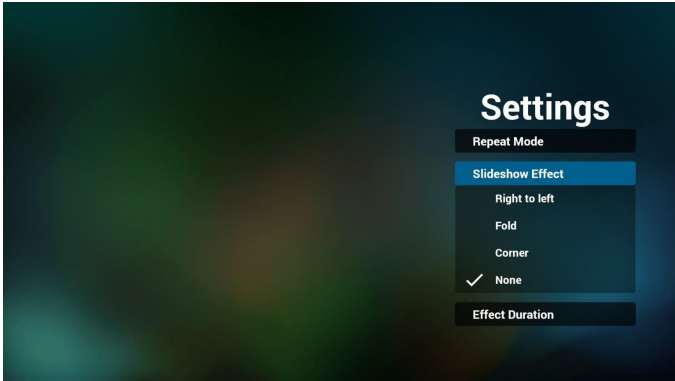

12. Media Hotkey

**Play:** play the file.

**Pause:** pause.

**Fast forward:** fast forward for 20 seconds. (photo mode is not supported)

**Rewind:** rewind for 10 seconds. (photo mode is not supported)

**Stop:** stop playing the file and return to start. If the file being played is a "gif" file, it will act as a pause key.

13. Media format please refer to **Page 56 Supported Media Formats**.

14. How to edit the playlist via FTP.

Step 1. Create a text file of media player:

- File name : mpplaylistX.txt, "X" means playlist number(1,2,3,4,5,6,7).

Ex. mpplaylist1.txt, mpplaylist2.txt

- Content :

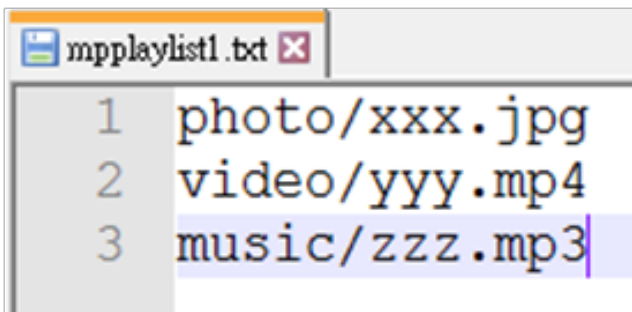

Note: If a playlist contains both video and music files, a black screen will display when the system plays the music file.

Step 2. Copy "mpplaylistX.txt" to "philips" folder of the internal storage. You may use FTP to do this.

- File path : /storage/emulated/legacy/philips

Ex. /storage/emulated/legacy/philips/mpplaylist1.txt

Step 3. Add the media files in "photo", "video" and "music" folders which are under "philips" folder of your internal storage.

- Ex. /storage/emulated/legacy/philips/photo/xxx.jpg  
/storage/emulated/legacy/philips/video/yyy.mp4  
/storage/emulated/legacy/philips/photo/zzz.mp3

Step 4. Start media player App, it will import the text file of media player automatically.

Note. Once the playlist file (text) is imported, any changes made through the remote control will not be recorded in the playlist text file.

## 4.5. Browser

Before using this feature, ensure that the system is connected successfully to the network. (See 5.1. Wi-Fi & 5.2. Ethernet)

1. Main page of "Browser" App which allows you to make related settings.  
Press **Settings** to make the settings.

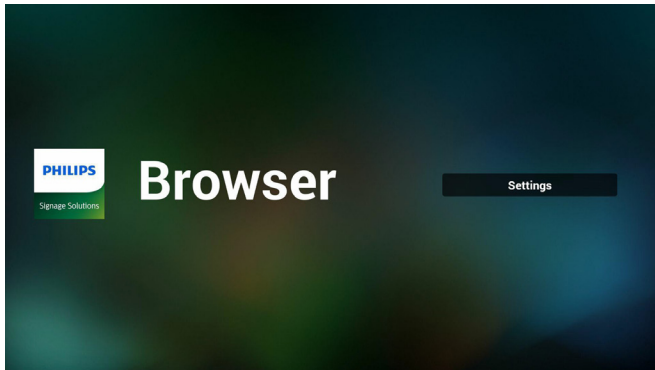

2. Up to 7 browsers can be set. Select one to make the settings.

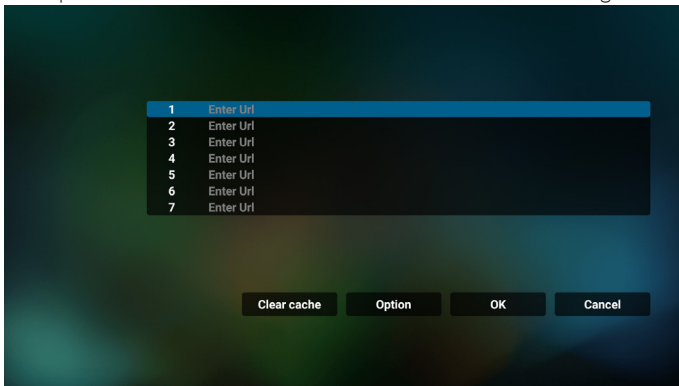

3. Use the on-screen keyboard to enter URL and press the **OK** button, the data will be saved in the List

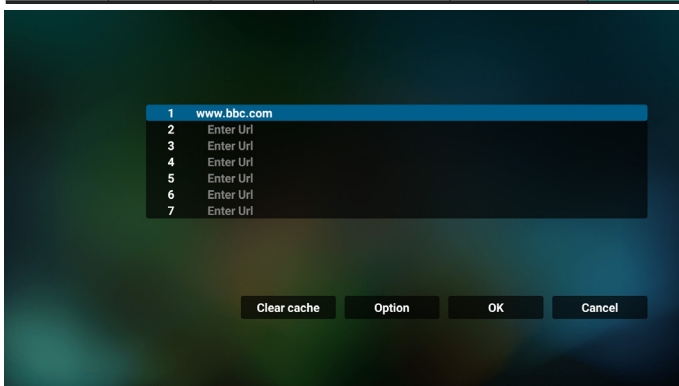
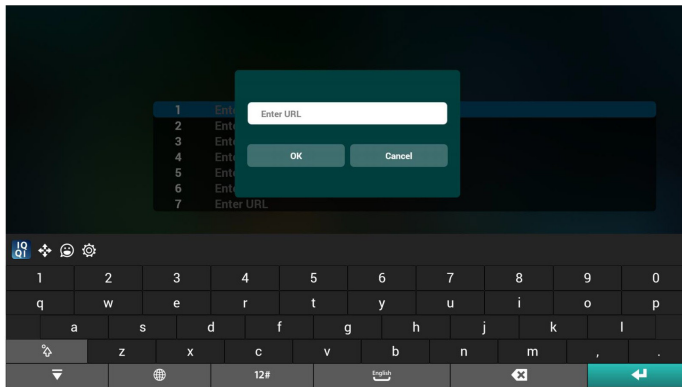

4. From the side menu bar on left side of the screen, the following functions are available:

**Import:** Import the file of URL list

**Export:** Export the file of URL list

**Delete all:** Delete all URL records from the main screen

**Back:** Close the side menu bar

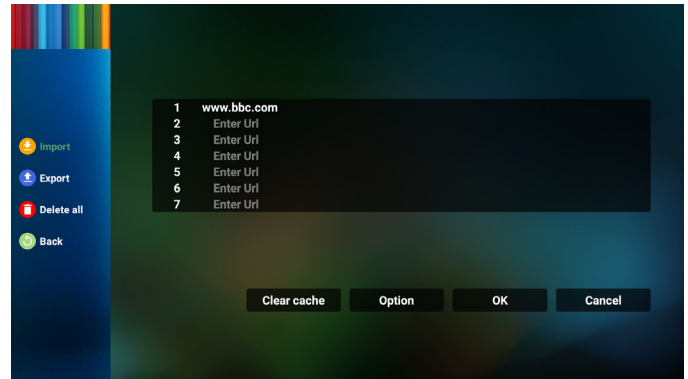

### 4.1 Import

- Select import.

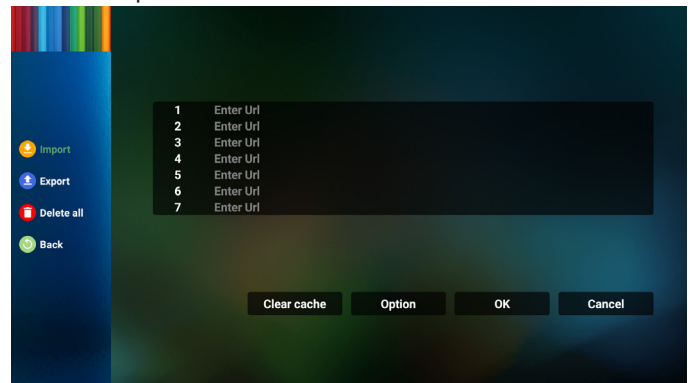

- Select the storage where the file will be imported from.

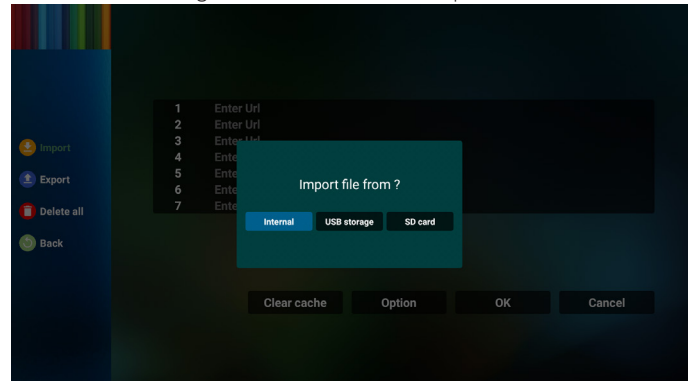

- Select a browser file

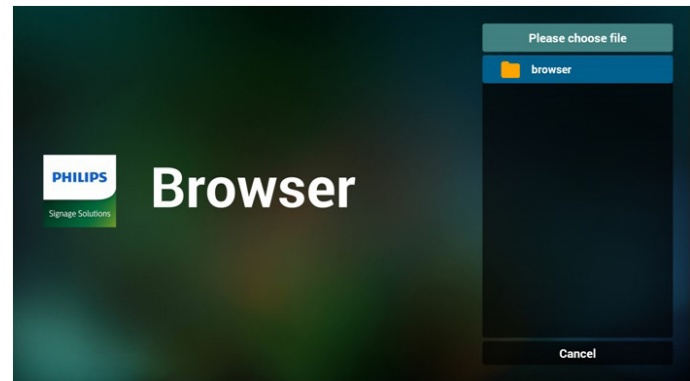



- Import the browser file and the URL will be listed on the screen.

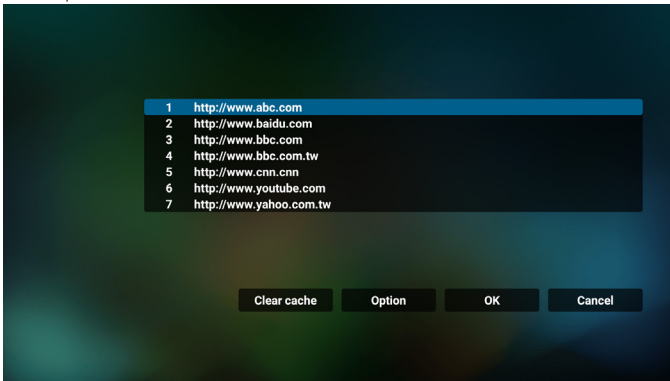

- A dialog box displays the path of the file to be saved as well as the file name. Press the "Save" button to save the URL.

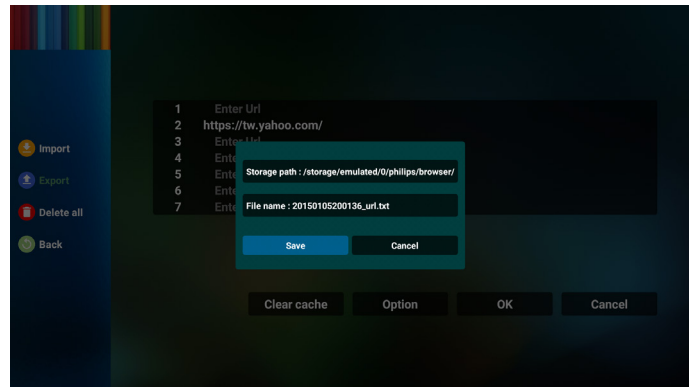

- The file format supported for import is ".txt".

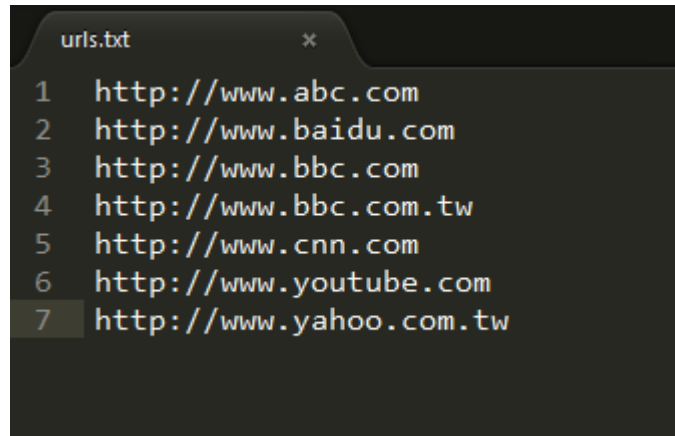

- 5. Press the "OK" button to save the URL record.

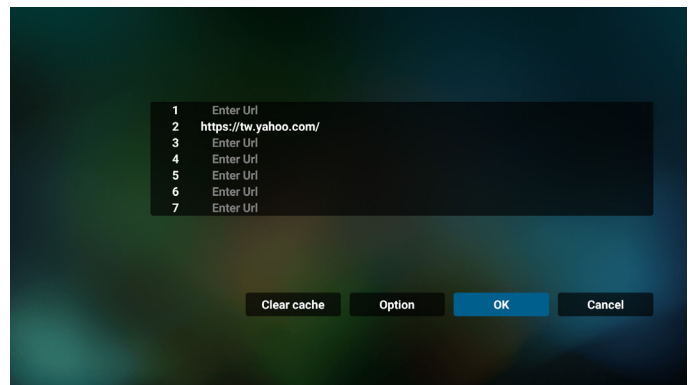

#### 4.2 Export:

- Select **export**

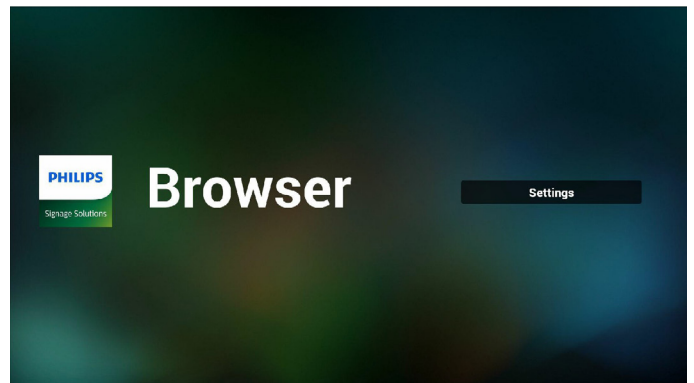
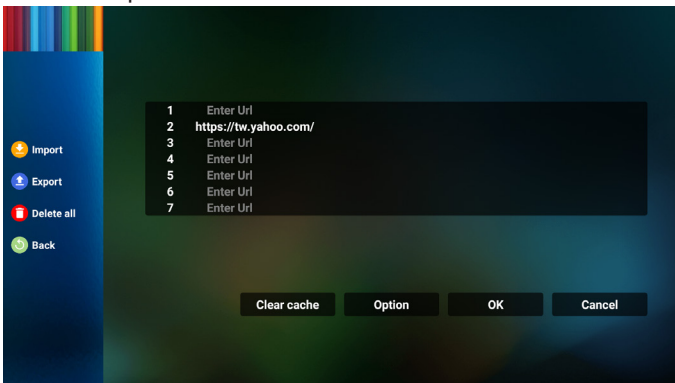

- Select the storage where the file will be exported to.

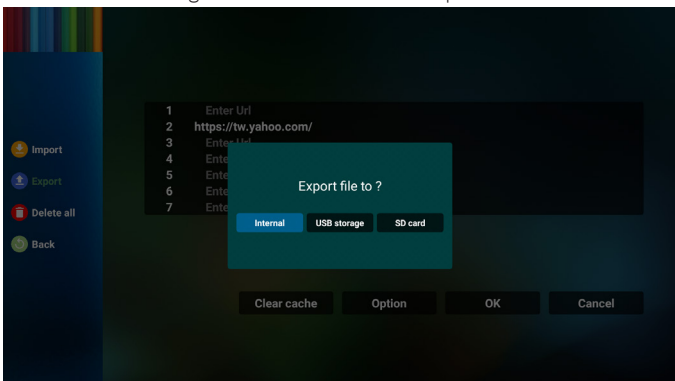

- 6. If you select a non-empty item from the URL list, a message will appear asking if you want to edit or play the URL. If you select "Edit" a dialog box allows you to edit the URL. If you select "Play", a web page of the selected URL appears.

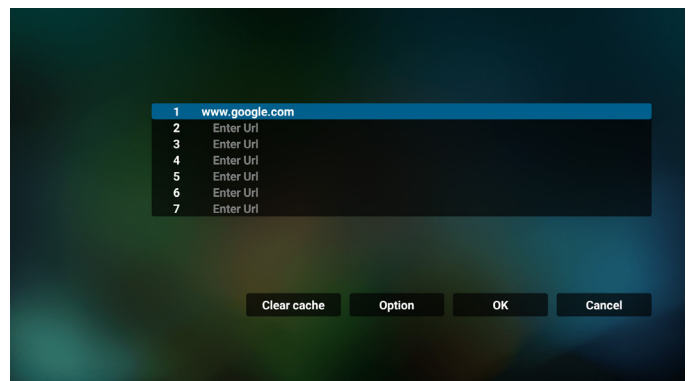

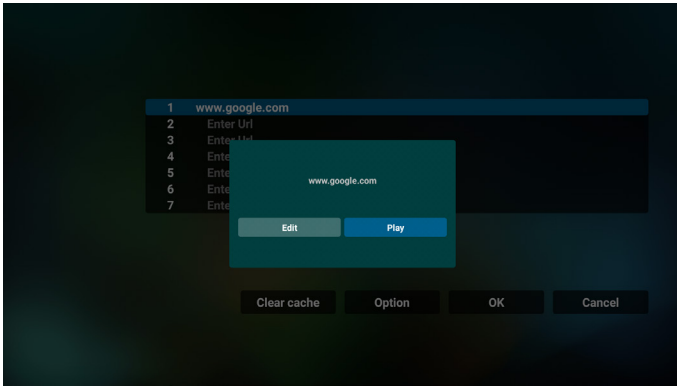

## 7. OSD menu interaction with Browser

### 7.1 Boot on source

- Set OSD menu > Configuration1 > Boot on source > set BROWER Play List to 0.  
Then PD will show Browser after rebooting.
- Set OSD menu > Configuration1 > Boot on source > set BROWER Play List to 1.  
The web page of the first URL from Browser App will be shown on the screen.

### 7.2 Schedule

Set OSD menu > Advanced option > Schedule >  
On time1, Off time2, Input BROWSER, the desired day you of the week, and the Playlist.  
Finally check the right box.  
The web page of the URL from Browser App will be shown on the screen at time1 and finished at time2.

## 8. How to edit url list via FTP

Step 1. Create a text file of media player:

- File name: bookmarklist.txt.
- Content:



Step 2. Copy bookmarklist.txt to "philips" folder of your internal storage. You may use FTP to do this.

- File path: /storage/emulated/legacy/philips (for DL, PL)

Ex. /storage/emulated/legacy/philips/bookmarklist.txt

Step 3. Start Browser App, it will import the text file of Browser automatically.

Note. Once the playlist file (text) is imported, any changes made through the remote control will not be recorded in the playlist text file.

## 9. Offline browsing

When Url 1 has set address, and use osd schedule to open Url 1 web page, browser app will automatically save home web page data of Url1 to local storage.

If network is disconnected while osd schedule opens browser app, browser app will automatically open Url 1 address home page in local storage.

Note:

- Browser app can only save Url 1 address home page data, other Url 2 to Url 7 cannot be saved.
- Local storage : /sdcard/Download/OfflineBrowsing
- Pressing "Clear cache" button can clear Url 1 address home page data from local storage.

## 4.6. PDF Player

### 4.6.1. OSD menu interaction with PDF player:

1. Boot on source:
  - Input:
    - If you select "PDF player" as the source, the system will launch PDF player automatically after the boot process is completed.
  - Playlist:
    - 0: go to the main page of PDF player.
    - 1 - 7: go to PDF player and playback File1 - File7 of the playlist automatically.
2. Schedule:
  - Today :
    - Show date and time.
  - □1 - □7 :
    - Set up to 7 schedules.
  - On/Off :
    - Set start time and end time.
  - Input :
    - Select PDF player as the source, the system will launch the PDF player automatically at end time.
  - MON,TUE,WED,THU,FRI,SAT,SUN, Every week :
    - Set life cycle.
  - Play list :
    - 0: go to the main page of PDF player.
    - 1 - 7: go to PDF player and playback File1 - File7 of the playlist automatically.
  - Clear all

### 4.6.2. PDF Player introduction:

1. The main page of PDF Player; this page consists of three options: "Play", "Compose" and "Settings".

**Play:** select a playlist to play.

**Compose:** edit the playlist.

**Settings:** configure the properties of PDF Player.

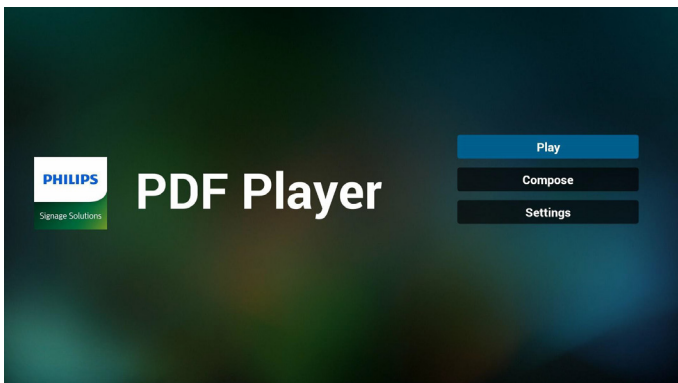

2. Select "Play" on the main page, first you should select one playlist to play between FILE 1 and FILE 7.

The pencil icon means that the playlist contains the content.

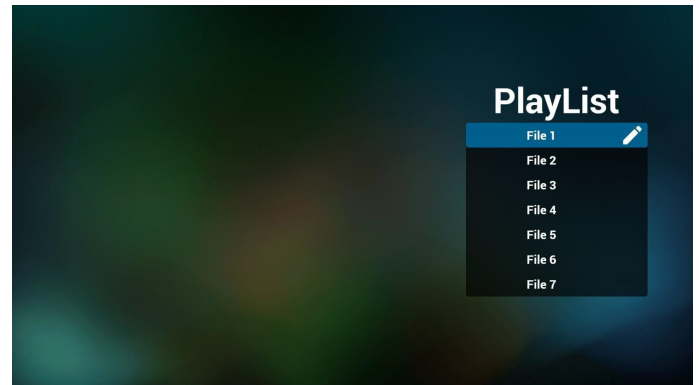

3. Select "Compose" on the main page, first you should select one playlist to edit between FILE 1 and FILE 7.

The pencil icon means that the playlist contains the content.

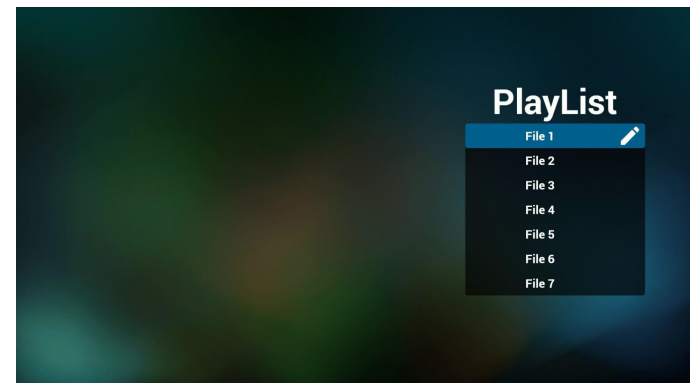

4. If an empty playlist is selected, the App will guide you through selecting the media source.

All media files should be stored in /philips/ of root directory. For example,

**pdfs : {root dir of storage}/philips/pdf/**

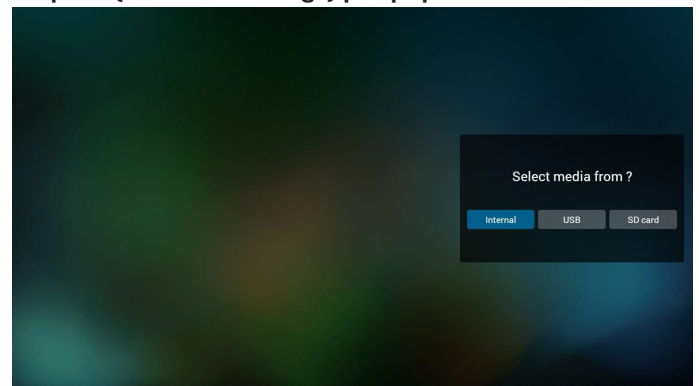

- To edit or delete a non-empty playlist, select the desired playlist that has a pencil icon on right side of the file.

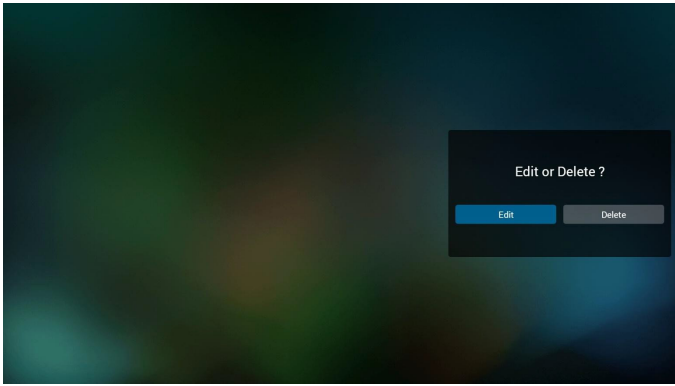

- Once you start to edit a playlist, a menu is displayed as below.

**Source**- files saved in the memory storage.

**Playlist**- files saved in the playlist.

The following functions can be operated through the corresponding keys on the remote control.

**Option key** – launch the side menu bar

**Play key** – play the media file.

**Info key** – show the media info.

**Ok key** – select/deselect a file.

6-1. From the side menu bar, the following functions are available:

- **Select all**: select all files saved in the storage.
- **Delete all**: delete all playlist files.
- **Add/Remove**: add or remove a playlist from source.
- **Sort**: sort the playlist.
- **Save/abort**: save or abort the playlist.
- **Back**: return to the previous menu.

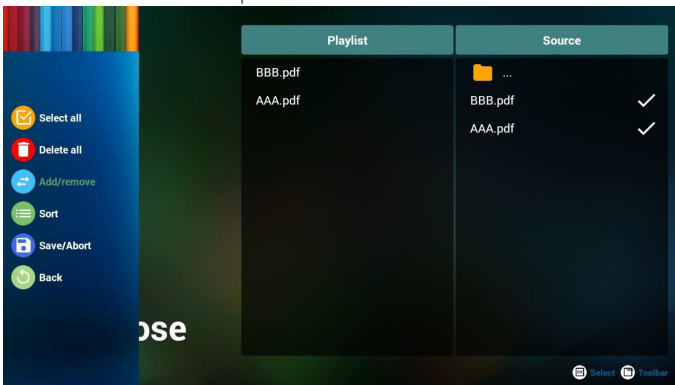

- If "Sort" is selected, you can customize the file order severally.

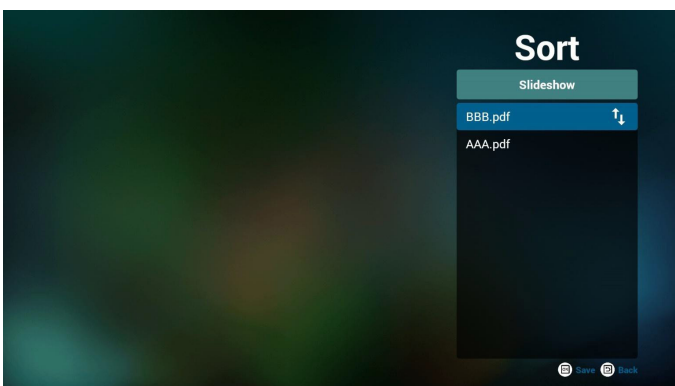

- Select "Settings" on the main page, there are two options available: "Repeat Mode" and "Effect Duration".

**Repeat Mode**: set the repeat mode.

**Effect Duration**: duration of photo effect.

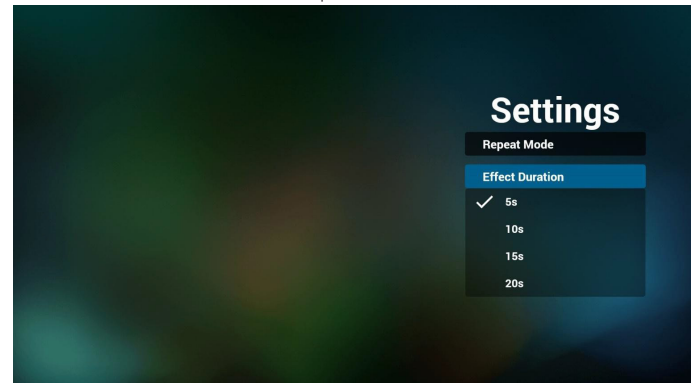

- How to edit the PDF list via FTP?

Step 1. Create a text file of PDF player:

- File name : pdfplaylistX.txt, "X" means playlist number(1,2,3,4,5,6,7).  
Ex. pdfplaylist1.txt, pdfplaylist2.txt
- Content:

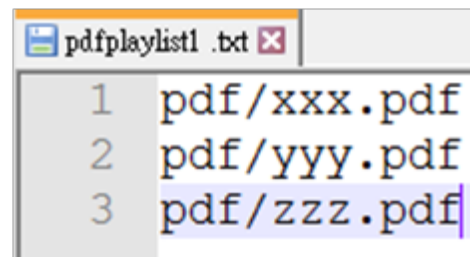

Step 2. Copy pdfplaylistX.txt to "philips" folder of the internal storage. You may use FTP to do this.

- File path : /storage/emulated/legacy/philips (for DL, PL)  
Ex. /storage/emulated/legacy/philips/pdfplaylist1.txt

Step 3. Add the PDF files in "PDF" folder which is under "philips" folder of your internal storage.

- Ex. /storage/emulated/legacy/philips/pdf/xxx.pdf  
/storage/emulated/legacy/philips/pdf/yyy.pdf  
/storage/emulated/legacy/philips/pdf/zzz.pdf

Step 4. Start the PDF player App, it will import the text file of PDF player automatically.

Note. Once the playlist file (text) is imported, any changes made through the remote control will not be recorded in the playlist text file.

### Media Hotkey:

**Play**: play the file.

**Pause**: pause.

**Fast forward**: skip to the next page. If the page is close to the end of file, it will go to the next file.

**Rewind**: skip back to the previous page. If the page is close to the beginning of file, it will go to the last file.

**Stop**: return to the first page of file.

## Color Hotkey:

**Blue:** Zoom in (+10%)

**Yellow:** Zoom out (-10%)

**OK:** Restore zoom

## Arrow keys:

**Up/Down/Left/Right:** Adjust the page. (when the page is zoomed in/out)

**Left:** Previous page. (when the page is not zoomed in/out)

**Right:** Next page. (when the page is not zoomed in/out)

## Combination key:

Number key + OK key: select a specific page and press **OK** key to change the page.

- Press a number key.

- Press **OK** key, the page number will be shown on the bottom side of the page. If the page number is greater than the total page number, it will keep the current page number at the bottom side of the page.

## 4.7. CMND & Play

1) Server

Setup CMND & Play server address

2) Account

Setup CMND & Play account

3) PIN Code

Setup CMND & Play PIN code

(4) Version

There are two options, Ver:2 and Ver:3

Ver: 2

use 2.0/2.2 agreement

Ver: 3

use 3.0/3.1 agreement

(5) Content

There are 3 options available: internal storage, SD card and USB storage.

If Ver:2, is selected, Server/Account/PIN code will be shown in gray and cannot be set.

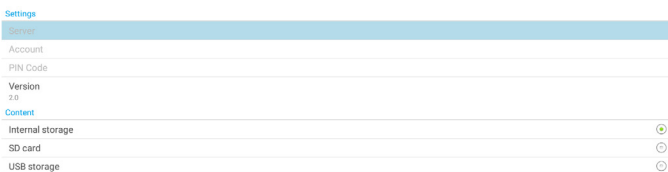

## 4.8. Custom App

Set up the application for Customer Source.

Note:

(1) Only display the App installed by user.

(2) System's pre-installed App is not displayed.

### 4.8.1. OSD Menu operation:

RCU: Source > Custom

If a customer APK is set, the PD will open the customer App when switching the source to Customer mode.

If the customer APK is not set, the PD will show a black screen when switching the source to Customer mode.

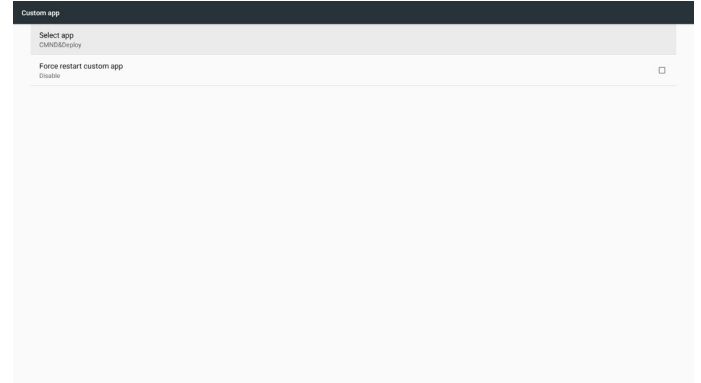

### 4.8.2. Function Introduction

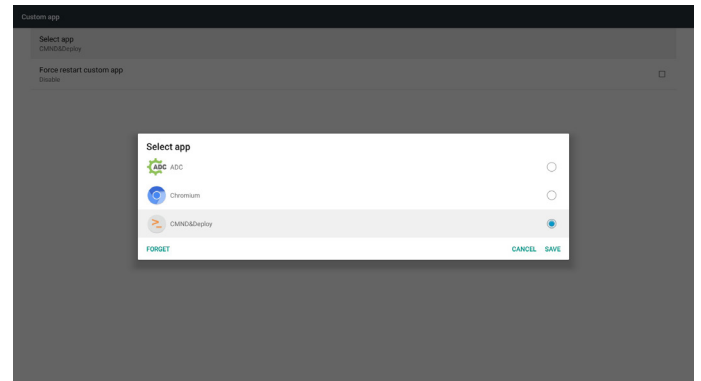

#### Save

Pressing **Save** will perform the function of storage.

#### Forget

After pressing **Forget**, those previously stored information can be removed.

#### Cancel

Cancel and close the dialog box.

If there is no customer installed APK, the list will be blank.

If the options are not available, "**Save**" and "**Forget**" keys will be shown in gray.

### 4.8.3. Force restart custom app:

If the app is closed due to an exception, the app will be automatically reopened.

## 5. Setting

Main items:

- (1) Wi-Fi
- (2) Ethernet
- (3) More (available when 4G module is connected)
- (4) Signage Display
- (5) Display
- (6) Apps
- (7) Security
- (8) Input method
- (9) Date & time
- (10) Developer options
- (11) About

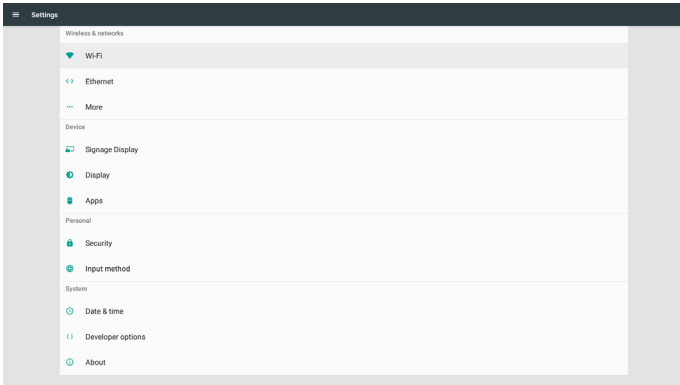

### 5.1. Wi-Fi

Go to the wireless network settings. On the available network list, select an AP (Access Point) on an existing wireless network.

Notes:

1. Ethernet will be disabled automatically if Wi-Fi is connected to the network correctly.
2. A particular model of Wi-Fi module is required. Please consult the dealer or service technician for help.

### 5.2. Ethernet

Go to the Ethernet network settings and make the required settings.

After enabling Ethernet, the following settings will show:

- (1) Connection Type (available connection types: DHCP and Static IP)

#### A. DHCP

DHCP automatically provides the IP address, Netmask, DNS Address and Gateway to access the Internet so you do not have to enter them manually.

If the connection is successful, the current network configuration will be displayed.

#### B. Static IP

Enter the IP address, Netmask, DNS address and gateway manually.

Note:

Input limitation of IP address, netmask, DNS address and gateway address

- (1) Format: number 0-9, decimal point “.”

- (2) Mac Address

Note:

Ethernet will be disabled automatically if Wi-Fi is connected to the network correctly.

### 5.3. More (available when 4G module is connected)

Control Cellular networks.

Note :

1. Available only when 4G module is connected.
2. The option of “Tethering & portable hotspot” is available only when Wi-Fi module is detected.
3. Network info will be different due to different carrier.

### 5.4. Signage Display

- (1) General Settings

- A. Signage display name
- B. Boot Logo
- C. Screenshot
- D. Navigation bar

- (2) Server Settings

- A. Email notification
- B. FTP
- C. Remote control

- (3) Source Settings

- A. Media player
- B. Browser
- C. CMND & Play
- D. PDF player
- E. Custom app

- (4) Network application

- A. Proxy
- B. SICP network port

- (5) System tools

- A. Clear Storage
- B. Reset
- C. Import & Export
- D. Clone
- E. Security

- (6) Misc.

- A. Tiling Tool
- B. TeamViewer Support

- (7) System updates

- A. Local update

- (8) Scaler FW updates

- A. Start update

#### 5.4.1. General Settings

1. Signage Display Name

Set PD name “PD\_” + Ethernet Mac Address.

Note:

Input limitation:

- (1) length: maximum 36 characters
- (2) format: no limitation

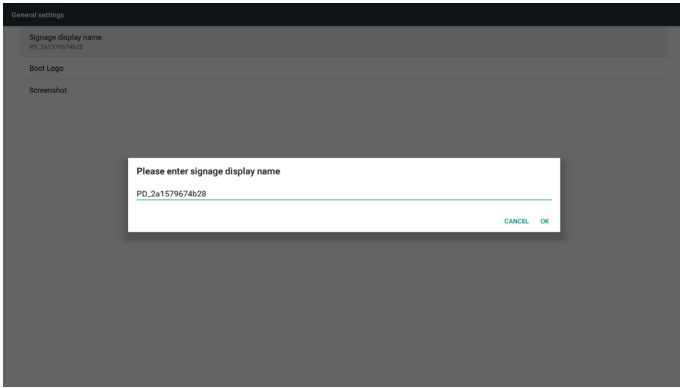

## 2. Boot Logo

### 1) Scalar OSD menu to control Android boot logo

Scalar OSD menu operation

RCU: Home > Configuration2 > Logo > On/Off/User

Under user mode, select your own animation file of boot logo file.

Note:

- (1) File name of boot animation: bootanimation.zip
- (2) USB and SD card will be selectable. No priority issue.
- 2) When boot logo is selected, the system will check if bootanimation.zip is present in the USB and SD card.

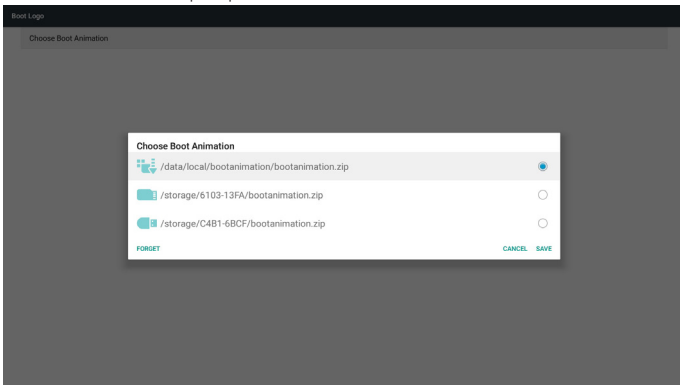

Function introduction:

#### a. Option description



Use customized boot animation file which is copied from SD card or USB



Use boot animations file under SD card



Use boot animations file under USB

#### b. Save

If you select  or , press **Save** key to save bootanimation.zip from the SD card or USB to /data/local and set it as boot logo.

#### c. Forget

Press **Forget** key to delete /data/local bootanimation.zip and conceal the boot logo.

#### d. Cancel

Cancel and close the dialogue box.

Scenario introduction:

#### Case 1

When the system cannot find bootanimation.zip file under SD and USB, the file list will be empty. The **Save** and **Forget** options become gray.

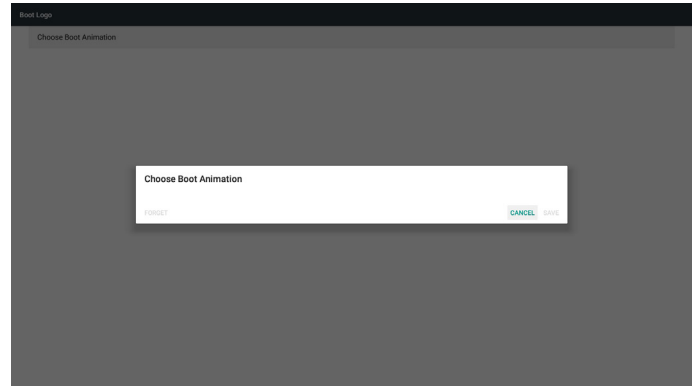

#### Case 2

The customized bootanimation.zip file can be stored in the SD and USB memory. The default priority is the SD card, meaning that the system selects the file in the SD card automatically. If the bootanimation.zip is stored only in the USB drive, then the system will select the file in the USB drive (as the SD card has no file).

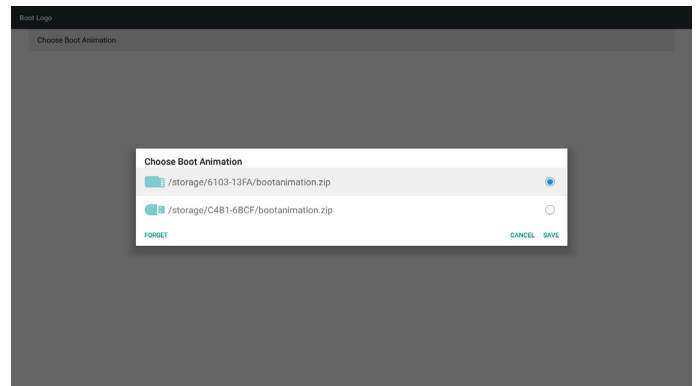

#### Case 3

When a customized boot logo is selected, the screen will show /data/local/bootanimation.zip.

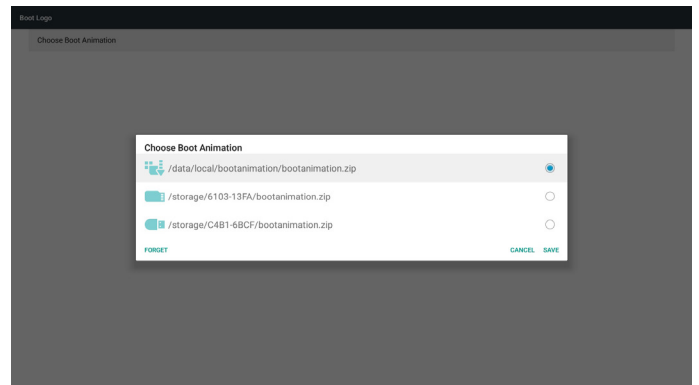

3) If the logo item of OSD menu is On or Off, then the boot animation in Android settings is not selectable.

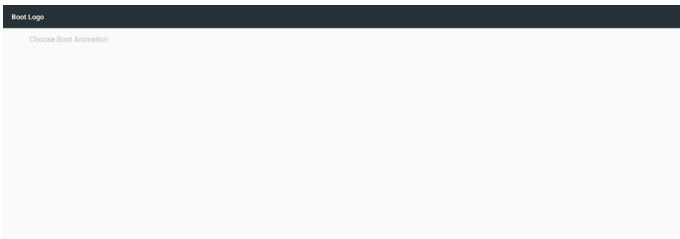

### 3. Screenshot

After enabling the screenshot feature, screenshot time slot and its saving path can be set.

Notes:

Time slot for deleting and taking the screenshot:

- (1) delete the picture at initial time which is 0 sec.
- (2) take the screenshot at the first 40 sec.

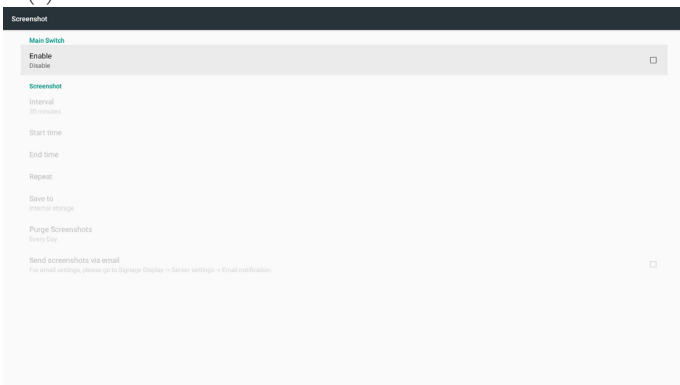

#### 1) Interval

Set interval time frame: 30 mins or 60 mins.

#### 2) Start Time

Set the time to start taking the screenshot.

Note:

- (1) If the start time is not set, the screen will show current time automatically
- (2) The start time cannot be later than the end time, otherwise it will show an error message.

#### 3) End Time

Set the end time to stop taking the screenshot.

Note:

- (1) If the end time is not set, the screen will show current time automatically
- (2) The start time cannot be later than the end time, otherwise it will show an error message.

#### 4) Repeat

Set the repeat mode for screenshot by setting the time frame. (multiple selection)

#### 5) Save to

Set the storage where the screenshot will be saved. The default storage is your internal storage.

Note:

The system creates a folder philips/Screenshot/ automatically in the root of your internal storage. The picture will be saved to philips/Screenshot/.

#### 6) Purge Screenshots

Set the interval time for deleting the screenshot images. The available options are "One day" and "One week".

#### 7) Send screenshots via email

Send the screenshot images as an e-mail attachment to the administrator.

Please refer to Email notification.

Note:

Ensure that Email setting is done, so that the screenshot can be sent immediately.

### 4. Navigation bar

Set up to show or hide the navigation bar during the touch operation.

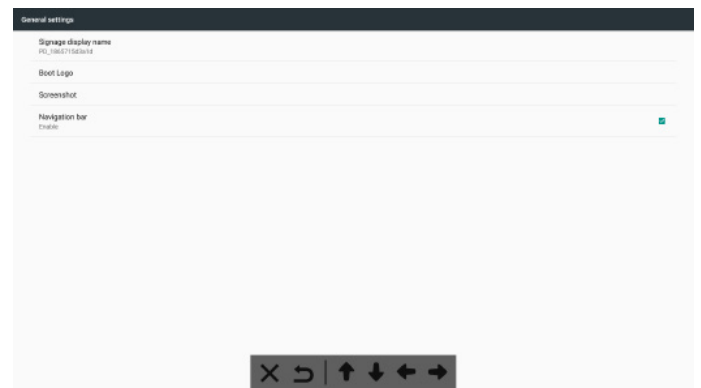

	Cancel	Cancel the navigation bar.
	Back	Back to the previous action.
	Top	Move the navigation bar to Top.
	Bottom	Move the navigation bar to Bottom.
	Left	Move the navigation bar to Left.
	Right	Move the navigation bar to Right.



## 5.4.2. Server Settings

### 1. E-mail Notification

Enable/disable the E-mail notification feature. Set E-mail notification configuration after enabling this feature.

Note: the following events are automatically sent to manager by E-mail:

- (1) Critical: warning message of Android system
- (2) Mediaplayer: playlist is empty, or media file is not supported...
- (3) Browser: playlist is empty,
- (4) CMND & Play: no content
- (5) Pdfplayer: playlist is empty
- (6) FTP: someone logs in to PD

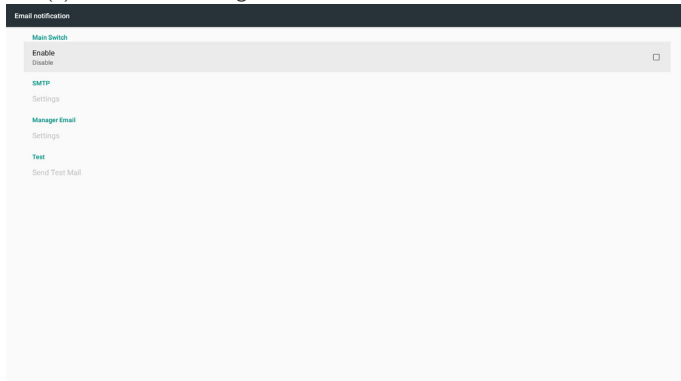

#### 1) SMTP

Set SMTP configuration.

Select Gmail account or other mail account and set the SMTP server, security type and port item.

Note

Password input limitation

- (1) Length: 6-20 characters
- (2) Format: no limitation

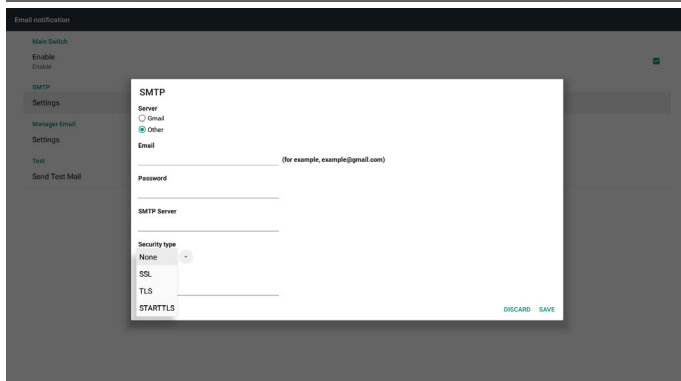
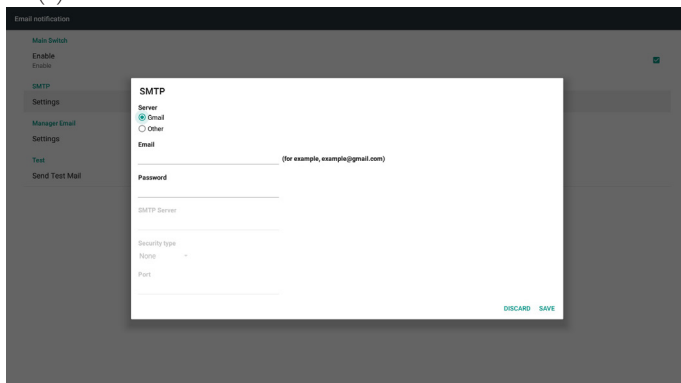

Gmail safety setting

If a problem occurs when sending the e-mail via Gmail, please visit Google website:

<https://www.google.com/settings/security/lesssecureapps>

for checking the security setting of your Google Account. Then turn on "Access for less secure apps".

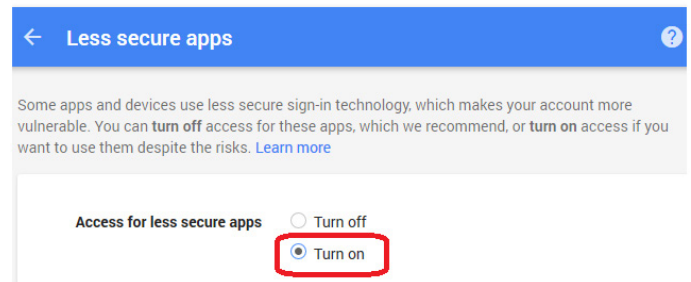

Yahoo Email Security Setting

If a problem occurs when sending the e-mail via Yahoo Email, enable the option of "Allow apps that use less secure sign in".

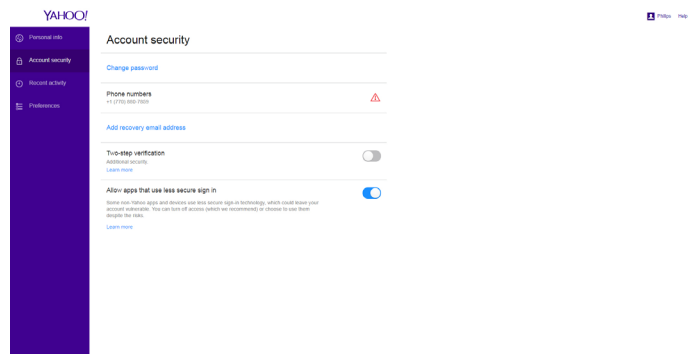

#### 2) Manager Email

Specify the destination address to receive the e-mail.

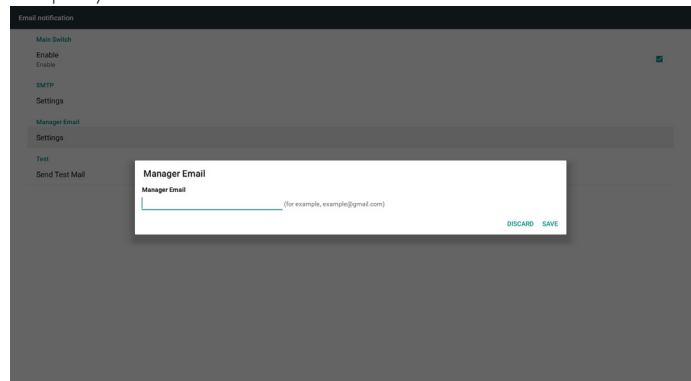

#### 3) Test

Send a Test Mail

To check if your Gmail account can receive/send e-mail.

Note

When Email is disabled, "Send Test Mail Button" button will gray out.

## 2. FTP

Click the checkbox to enable/disable the FTP server feature. After enabling this feature, files can be shared on the FTP.

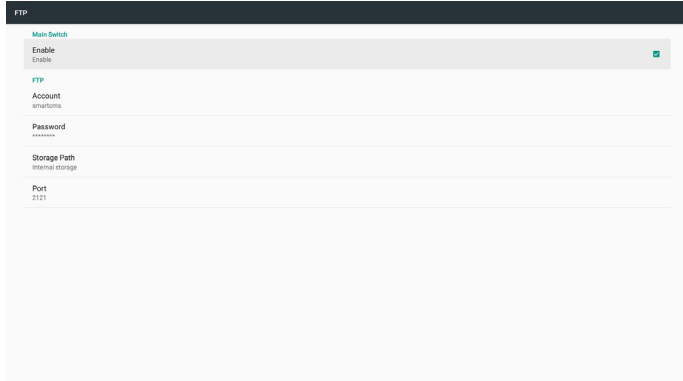

### 1) Account

Set FTP account

Note:

Input limitation

- (1) Length: 4-20 characters
- (2) Format:
  - I. English letter: a-z and A-Z
  - II. Number 0-9

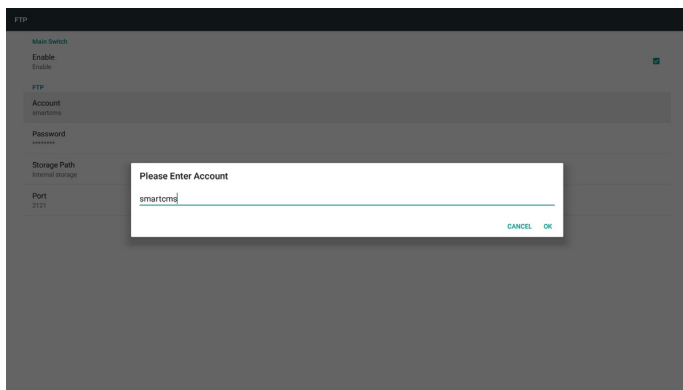

### 2) Password

Set the password for FTP.

Note:

Input limitation

- (1) Length: 6-20 characters
- (2) Format:
  - I. English letter: a-z and A-Z
  - II. Number 0-9

FTP password display

- (1) The password are hidden under asterisks if the password is set using the remote control.
- (2) After setting, the password are hidden under asterisks.

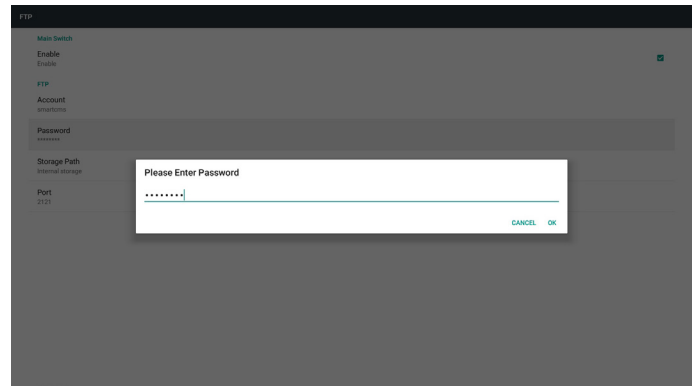

### 3) Storage Path

Show default path: Internal storage.

Note:

Display the path of internal storage which is unchangeable.

### 4) Port

Set FTP port number:

Note:

Input limitation:

- (1) Length: Max 5 characters
- (2) Range: 1025 ~ 65535
- (3) Format: Number 0-9
- (4) Default: 2121
- (5) Unavailable port: 9988, 15220, 28123, 28124 and SICP network port.

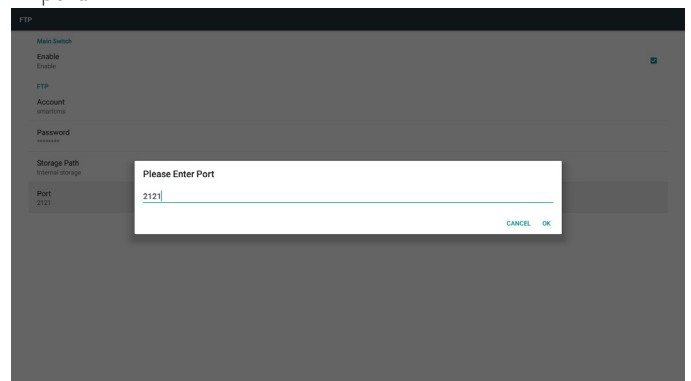

## 3. Remote Control

Enable or disable the remote control.

Input the server address. If the server is not registered, you will be asked to enter the PIN code.

Bind status:

- (1) If the device does not have appropriate network connection, a message "Network is disconnected" will appear.
- (2) If the device is equipped with network function, but is not connected to the remote control server; a message "Server is disconnected" will appear.
- (3) Show "Server is unbinded" if the remote control server replies its unbound status.
- (4) Show "Server is binded" if the device is bound with Sever successfully.
- (5) Show Error PIN code if the PIN code is not correct.

### 5.4.3. Source Settings

1. Media Player (Please refer to the instructions of 4.4. Media Player)
2. Browser (Please refer to the instructions of 4.5. Browser)
3. CMND & Play (Please refer to the instructions of 4.7. CMND & Play)
4. PDF Player (Please refer to the instructions of 4.6. PDF Player)
5. Custom App (Please refer to the instructions of 4.8. Custom App)

### 5.4.4. Network application

1. Proxy

Enter the Host and Port of the proxy server:

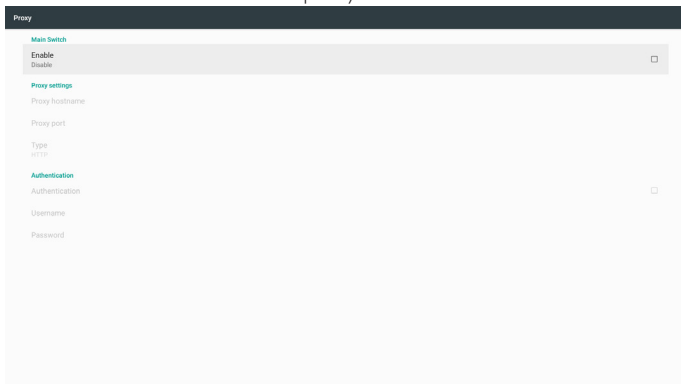

2. SICIP network port

Change SICIP Network Port.

Note:

Input limitation

- (1) Length: Max 5 characters
- (2) Range: 1025 ~ 65535
- (3) Format: Number 0-9
- (4) Default: 5000
- (5) Unavailable port: 9988, 15220, 28123, and 28124.

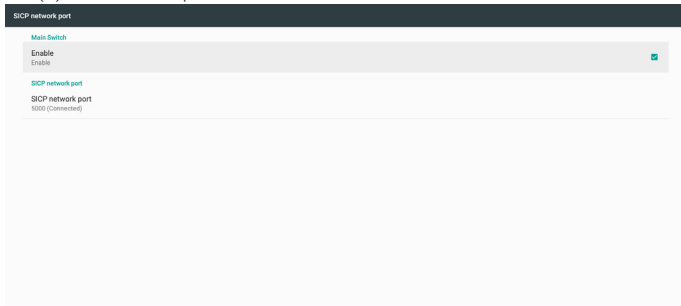

### 5.4.5. System Tools

System tools consist of 5 main functions:

- (1) Clear Storage
- (2) Factory Reset
- (3) Import & Export
- (4) Clone Media Files
- (5) External Storage

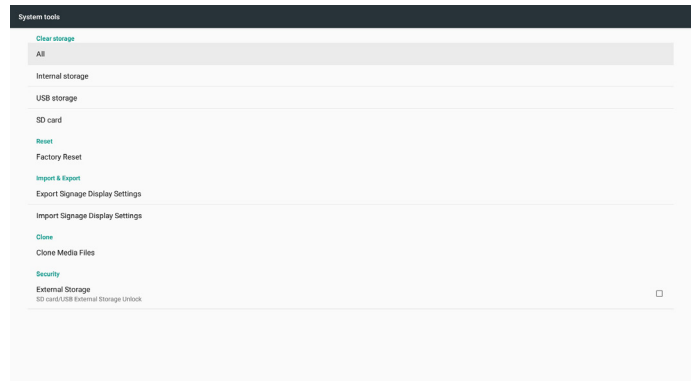

#### 5.4.5.1 Clear Storage

The purpose is to clear data in the folder "Philips". It is divided into 4 modes:

- (1) Clear all Philips folders.
- (2) Clear the folder "Philips" from the internal storage only.
- (3) Clear the folder "Philips" from the USB storage only.
- (4) Clear the folder "Philips" from the SD card only.

A dialog box lists all folders that the system is going to clear:

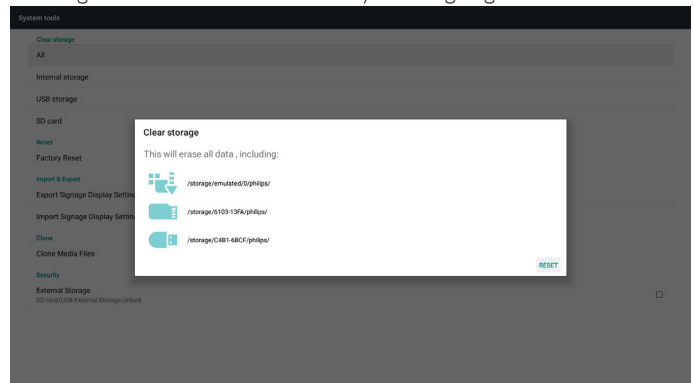

#### 5.4.5.2 Factory Reset

This function allows you to clear all user settings and recover to factory default values.

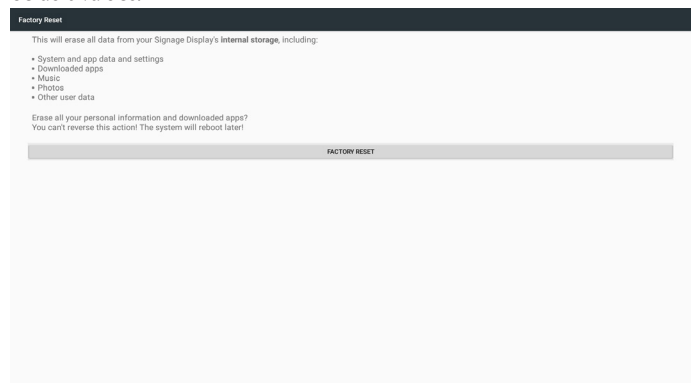

Press **OK** to execute Reset function automatically.

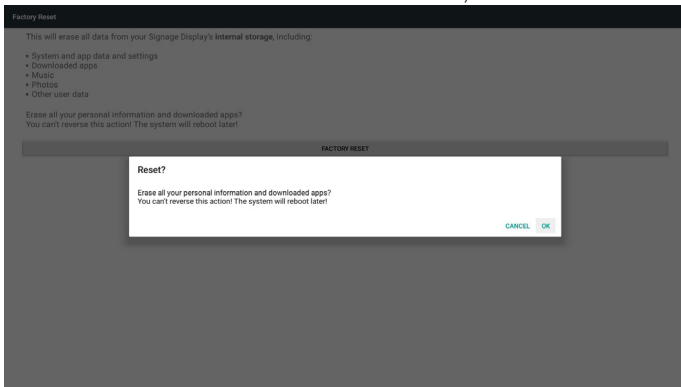

### 5.4.5.3 Import & Export

This function allows you to import/export the settings and 3rd party APK from/to other device.

Notes.

(1) Saved file name:

- A. Settings\_global.xml
- B. Settings\_secure.xml
- C. Settings\_system.xml
- D. Signage\_settings.db
- E. AndroidPDMediaPlayerData.db
- F. AndroidPDPdfData.db
- G. AndroidPDUrllistData.db
- H. Smartcms.db

(2) The files will be exported to philips/sys\_backup folder of the selected storage.

### Export Signage Display Settings

Database will be exported to the folder "Philips" of your USB or SD card.

- (1) Export database
- (2) Export 3<sup>rd</sup> party APK to Philips/app/

Note:

If the selected storage (USB storage or SD card) does not contain the folder "Philips", then the system will create it automatically.

A list of all available storage (internal storage/SD card/USB storage):

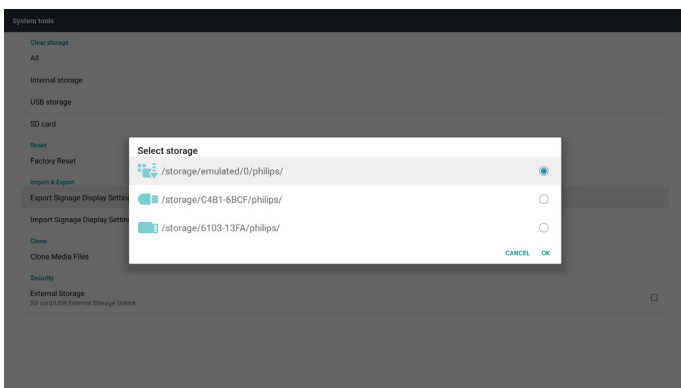

### Import Signage Display Settings

Data can be imported from the folder "Philips" of the selected storage (USB storage or SD card).

- (1) Import the settings and apps
- (2) Auto install 3<sup>rd</sup> party APK from Philips/app/

A list of all available storage (internal storage/SD card/USB)

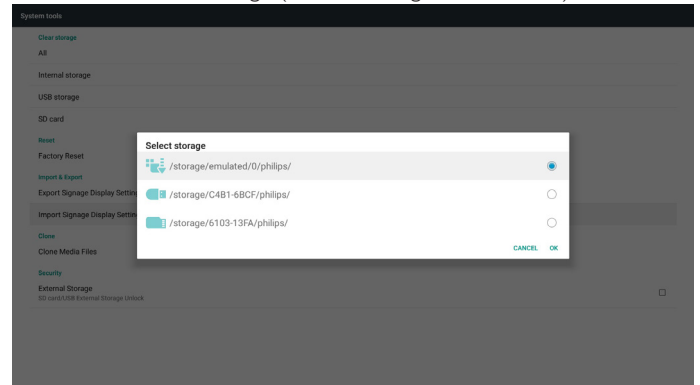

A confirmation dialog box is displayed before importing the settings and apps.

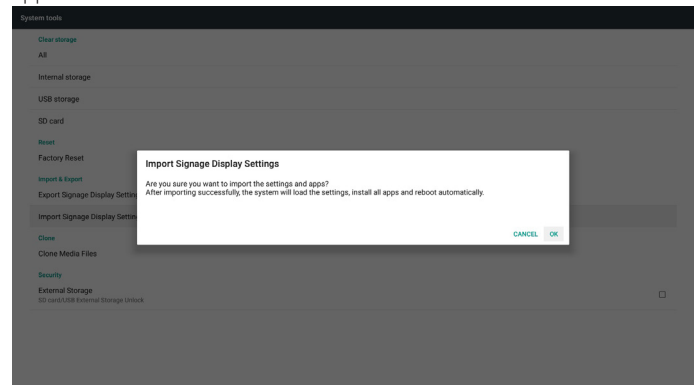

### 5.4.5.4 Clone Media File

This function allows you to copy the media files from the folder “Philips” of your source storage (internal, SD card or USB).

1. The following folders will be copied (under the folder Philips)

- (1) philips/photo
- (2) philips/music
- (3) philips/video
- (4) philips/cms
- (5) philips/pdf
- (6) philips/browser

2. File extension of cloned file is “.cms”)

Source storage

- (1) Internal storage
  - (a) check FTP
  - (b) check /Philips/ folder
- (2) SD/USB

Files under root

Target Location

- (1) Internal storage
  - Save to /Philips/
- (2) SD/USB
  - Save to root

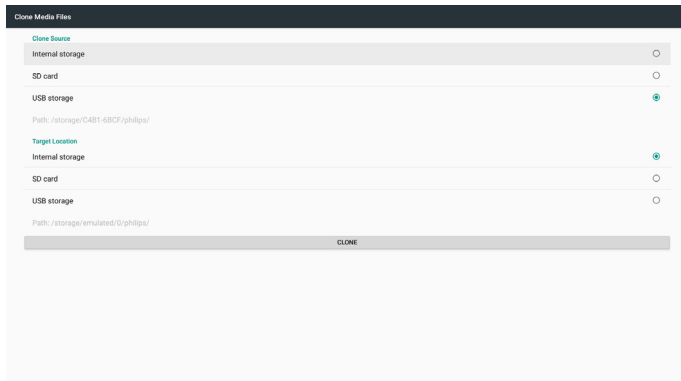

### 5.4.5.5 External Storage

Enable: lock the SD card/USB External Storage.

Disable: unlock the SD card/USB External Storage.

Note:

Insert the SD card/USB External Storage back to the device after unlocking the external storage.

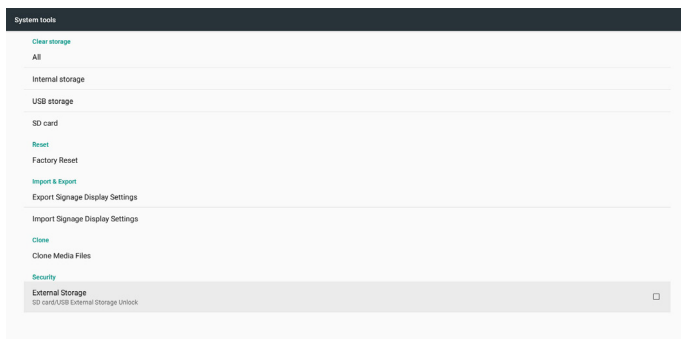

### 5.4.6. Misc.

#### 5.4.6.1 Tiling tool

To activate the tiling tool function, enter the serial number provided by your dealer:

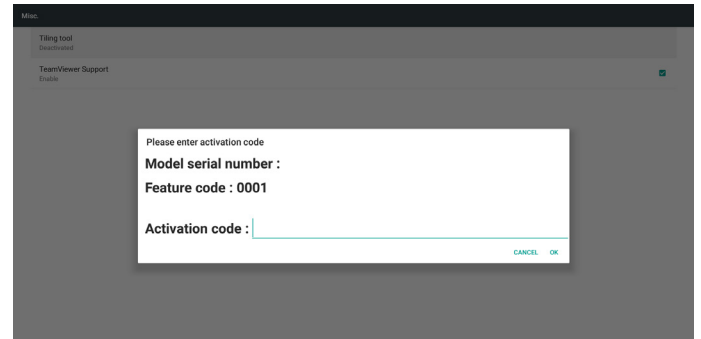

#### 5.4.6.2 TeamViewer Support

Enable/Disable the TeamViewer support.

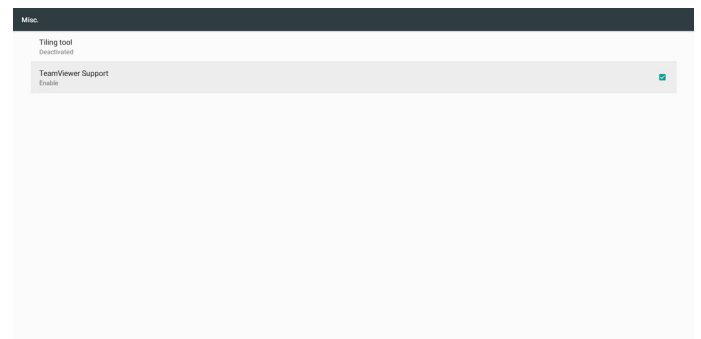

### 5.4.7. System update

1. Local update

The system will auto search “update.zip” from the internal storage, USB disk or SD card. If it is found, it will be shown on the list.

Note:

- a. It only supports Android full image.
- b. The file name should be “update.zip”
- c. The file should be stored in the root folder of your storage.

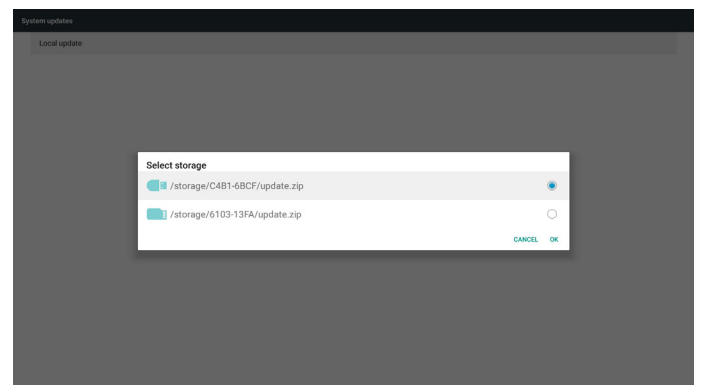

(2) After selecting the file "update.zip", the system will restart and start updating.

(3) If "update.zip" is not found, the message "no content" appears. (OK button will be shown in gray)

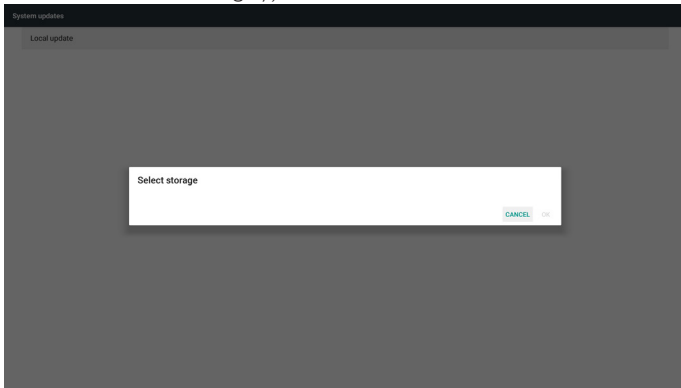

### 5.4.8. Scalar FW update

1. Start updating

It automatically searches the file "scaler.bin" in internal storage.

Notes

- (1) File name should be scaler.bin
- (2) The file should be stored in {Internal}/philips/scaler/

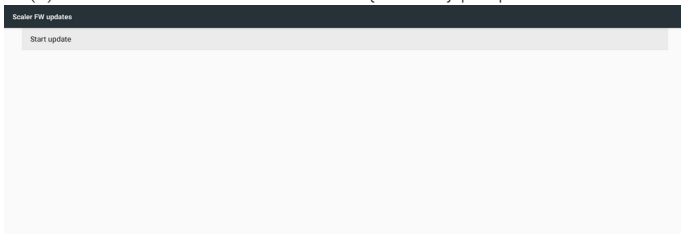

Note: If a black screen appears during updating process, please manually remove the AC power and plug it in again to complete the updating process.

## 5.5. Display

Set the font size of display from Small/Default/Large/Largest.

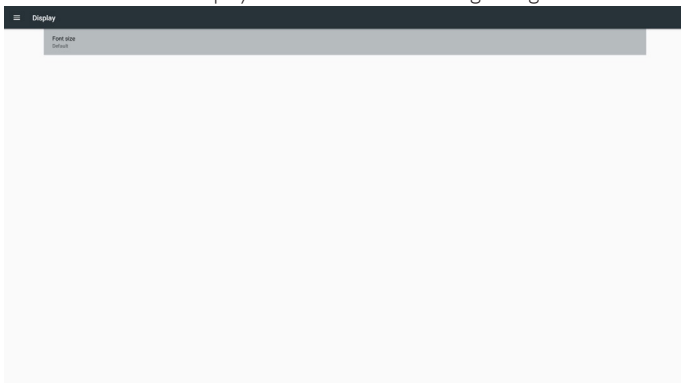

## 5.6. Apps

Display application information.

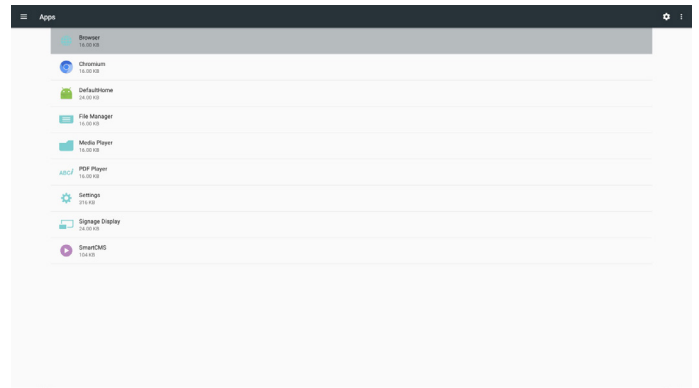

## 5.7. Security

- (1) Device administration: View or deactivate device administrators.
- (2) Credential storage: Display trusted CA certificates.

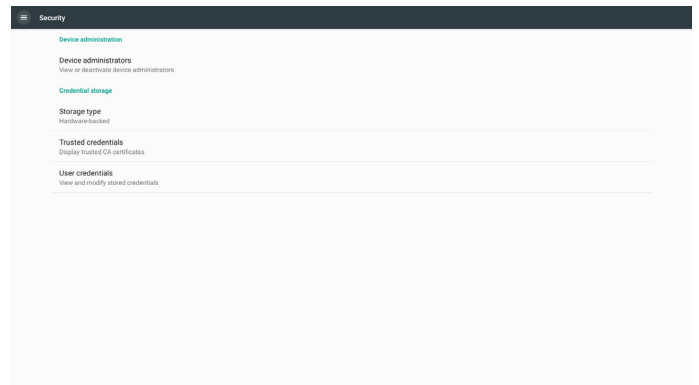

## 5.8. Input method

- (1) On-screen keyboard enable: Show or hide the software keyboard on screen.
- (2) Email auto-complete: Autocomplete for email addresses in android.

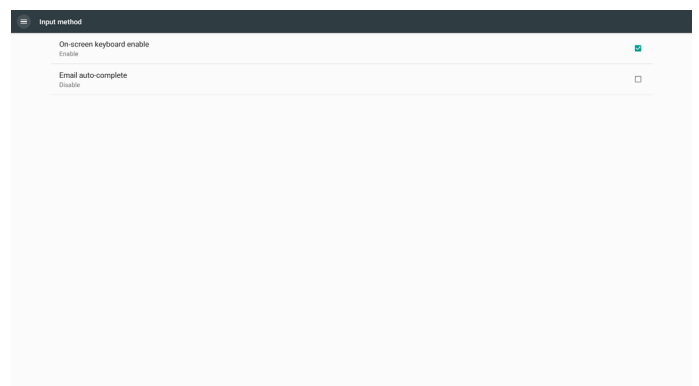

## 5.9. Date & time

Allow users to change time zone settings.

Tap "NTP Server" to set the custom NTP server address.

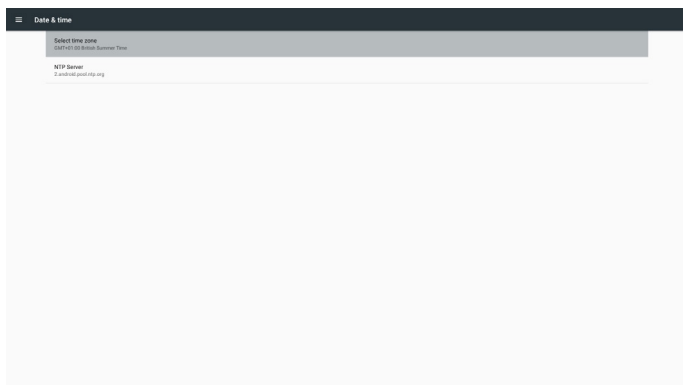

## 5.10. Developer options

Android developer options. For more information please visit <https://developer.android.com/index.html>

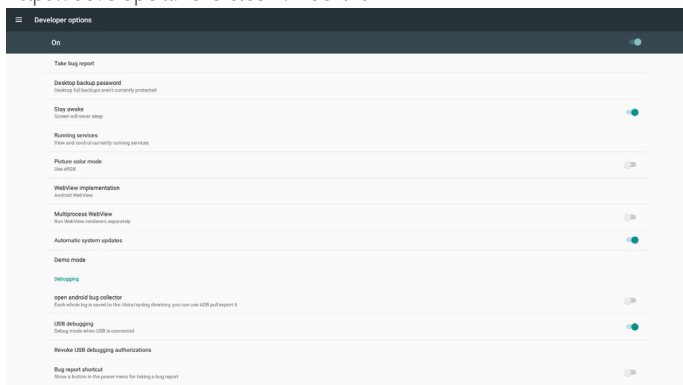

## 5.11. About

View the following information of the system:

- (1) Legal Information: show the open source licenses.
- (2) Android version
- (3) Kernel version
- (4) Build number

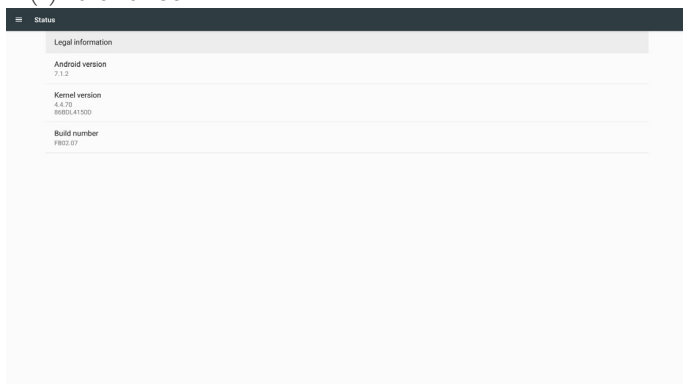

## 5.12. Supplementary

### 5.12.1. Quick Info

Press "Info + 77" to startup quick info.

Quick info will show "Network" and "Monitor Information".

Note:

Operation hours: updates every minute.

Heat status : updates every 5 seconds.

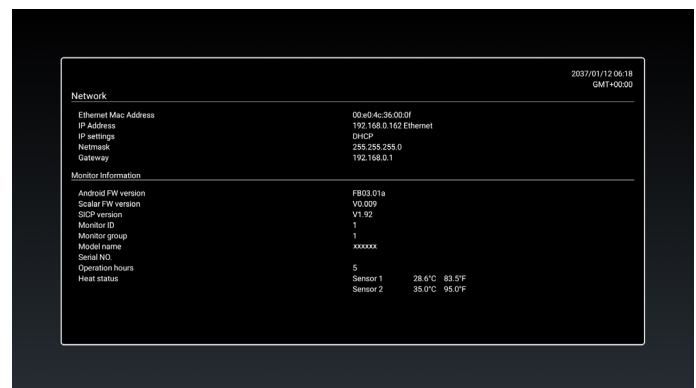

### 5.12.2. How to custom an Android boot animation?

1. Overview

The Android boot animation is a script used to load PNG files when the device boots. It is included in an **uncompressed** zip file called **bootanimation.zip**.

2. In the bootanimation.zip file

The bootanimation.zip as follow:

- The image folder (contains PNG images named in incremental numbers)
- The desc.txt file

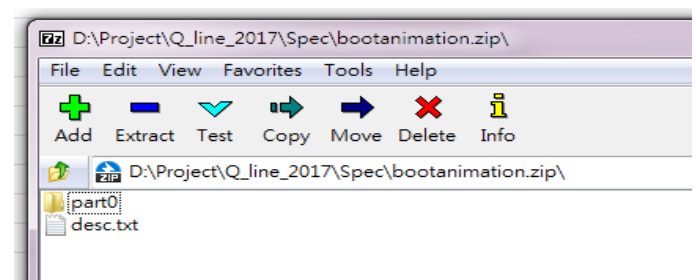

- (1) The image folder

This folder contains PNG images which are named by numbers, starting from something like 0000.png or 0001.png and proceeding with increments of 1. The minimum number of folder is 1 and the maximum number of folder is unlimited.

- (2) The desc.txt file

This file defines how the images in the folder(s) are displayed during the boot animation, in the following format:

- Width Height Frame-rate
- mode Loop delay-time Folder1
- mode Loop delay-time Folder2

An example of a desc.txt file is:

- 1920 1080 30

- p 1 0 part0
- p 0 0 part1

a. The first line

1920 and 1080 define the width and height of the screen resolution.

30 is the frame rate in fps (frames per second) i.e. number of images to display per second.

b. The second and third lines have a same format.

The first "p" means that the play mode stops immediately when the boot process is complete.

The number next to 'p' defines the repeat mode

- Set to 0 to make the part loop indefinitely until the device boot is complete.
- Set to 1 to make the part playback for once.

The next number defines the delay time(ms). For example, if it is set to 10, the system will be delayed for 10ms when all image files finished playing.

Part0 and part1 refer to image folder names.

As to the above example, the boot animation will play at a resolution of 1920 by 1080 pixels, at a frame rate of 30 fps, starting with the contents of part0 folder. After playing them in one loop, switch to the contents of part1 folder and play them continuously until the device boot process is complete.

### 3. Zip file:

Select all (including image folders and desc.txt) inside the Bootanimation folder and zip them into a new **uncompressed zip archive** using your favorite compression utility such as 7zip or WinRAR and so on.

If using 7zip, set compression level to "Store".

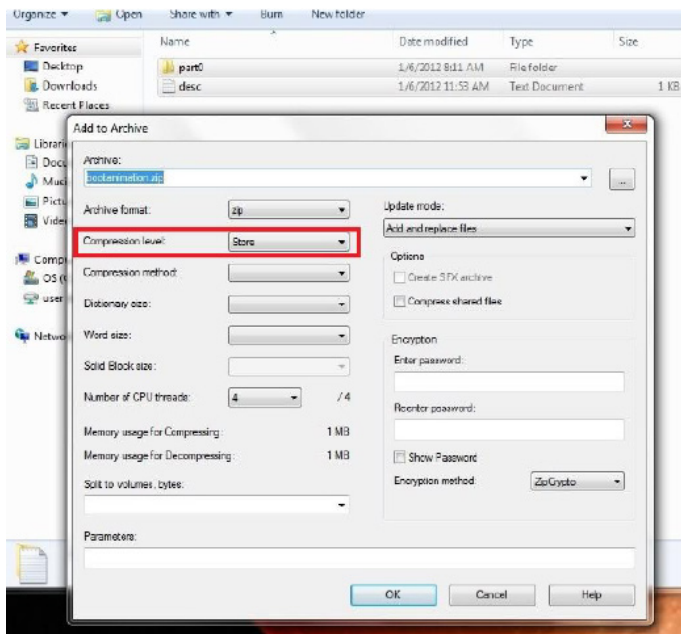

If using WinRAR, set "Compression method" to "Store".

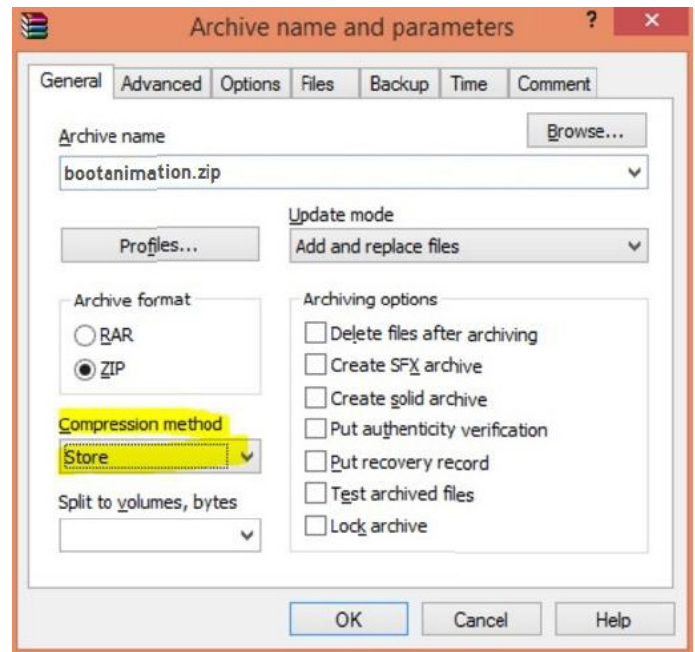

or bootanimation WON'T work

### 4. Apply the custom bootanimation

Procedure:

- (1) Place your custom bootanimztion.zip file into the external SD card or USB and plug the storage device into Phillips PD platform.
- (2) Make sure that the Logo option is enabled.

Press the Home key on RCU: **OSD menu > Configuration 2 > Logo > set "User"**

(3) Press the combination key "Home + 1888" on RCU to go to Admin mode:

**Settings > Signage Display > GENERAL SETTINGS > Boot Logo**

(4) The system will search the bootanimation.zip on the external SD card or USB automatically and copy it to /data/local

(5) Once the step 1~4 are complete, restart the system. The new customized boot animation should be displayed during boot time.

### 5.12.3. How to Install Android app?

There are 3 ways to install your own Android App.

#### (a) Via File Manager in Admin Mode

1. If you have apk already

- 1.1 Copy your APK to the USB disk or SD card, and plug the storage device into Philips Android Signage Display.
- 1.2 Go to **Admin Mode > Apps > File Manager**
- 1.3 Use File Manager to find your APK to be installed. Simply press "OK" on the selected APK.

2. Download an APK using the Chromium browser, then go to <internal storage path>/Download/ by File Manager.

- 2.1 The next steps are the same as described above. Please note, each model may have different <internal storage path>.



(b) Via Adb Shell

1. Make sure that your PC can connect to Philips Android Signage Display using adb.
2. Prepare your apk in a folder(for example, C:\apkfolder) on your PC.
3. Execute the following instruction using command line tool.  
C:\apkfolder> adb install -r apk\_name.apk

(c) Via Customized Intent

1. If you develop an apk which can download any Android App, then your APK can issue a customized intent.
2. Giving that the apk name and the path have been stored., the system will help you to install by program.

Description	Intent	Parameters	
Sw Update	php.intent.action.UPDATE_APK	filePath	The absolute file path including the file name. Please make sure that the file access permission should be 664 at least.
		keep	Indicate that you want to keep the file or not after updating.The default value is false.
		packageName	The target package you want to launch automatically after updating.
		activityName	The target activity you want to launch automatically after updating. But if current top activity is not activityName, nothing happened.
		isAllowDowngrade	"true: update apk no matter the version of target apk is lower than the version of current one or not.  false: stop install if it is downgrade."

For example,

```
Intent intent = new Intent();
intent.setAction("php.intent.action.UPDATE_APK");
intent.putExtra("filePath", "/sdcard/Download/sample.apk");
intent.putExtra("keep", true);
intent.putExtra("packageName", "com.tpv.example");
intent.putExtra("activityName", "com.tpv.example.MainActivity");
intent.putExtra("isAllowDowngrade", true); // allow downgrade
sendBroadcast(intent);
```

## 6. OSD Menu

An overall view of the On-Screen Display (OSD) structure is shown below. You can use it as a reference for further adjustment of your display.

### 6.1. Navigating the OSD Menu

#### 6.1.1. Navigating the OSD menu using the remote control

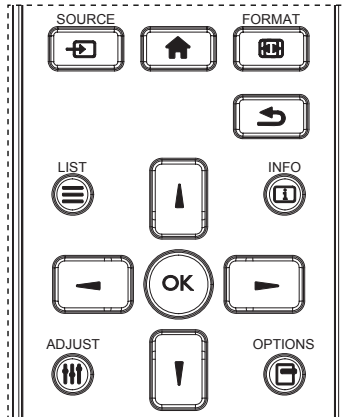

1. Press [HOME] button on the remote control to display the OSD menu.
2. Press [LIST] or [INFO] button to choose the item you want to adjust.
3. Press [OK] or [RIGHT] button to enter the submenu.
4. In the submenu, press [LIST] or [INFO] button to toggle among items, press [LEFT] or [RIGHT] button to adjust settings. If there is a submenu, press [OK] or [RIGHT] button to enter the submenu.
5. Press [FORMAT] button to return to the previous menu, or press [HOME] button to exit the OSD menu.

NOTES:

- When there is no OSD menu on the screen, press [LIST] to display the menu of {Smart picture}.
- When there is no OSD menu on the screen, press [INFO] to display the menu of {Audio source}.

#### 6.1.2. Navigating the OSD menu using the display's control buttons

1. Press [MENU] button to display the OSD menu.
2. Press [+] or [-] button to choose the item you want to adjust.
3. Press [+] button to enter the submenu.
4. In the submenu, press [▲] or [▼] button to toggle among items, press [+] or [-] button to adjust settings. If there is a submenu, press [+] button to enter the submenu.
5. Press [MENU] button to return to the previous menu, or press [MENU] button several times to exit the OSD menu.

## 6.2. OSD Menu Overview

### 6.2.1. Picture menu

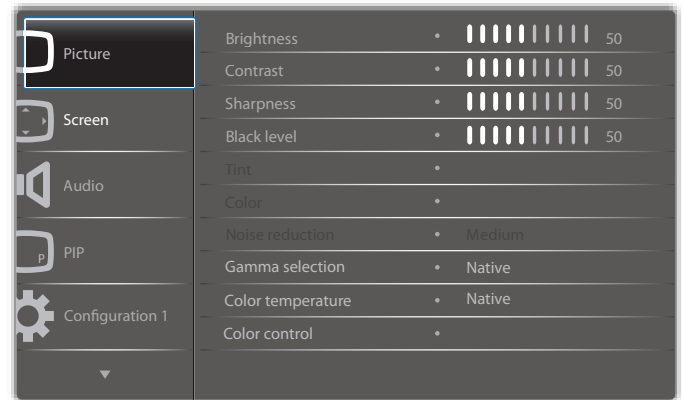

#### Brightness(Picture)

Adjust the overall image and background screen brightness(backlight).

#### Contrast

Adjust the image contrast ratio for the input signal.

#### Sharpness

This function is digitally capable to keep crisp image at any timings. It is adjustable to get a distinct image or a soft one as you prefer and set independently for each picture mode.

#### Black level

Adjust the image brightness for the background.

NOTE: sRGB picture mode is standard and cannot be changed.

#### Tint(Hue)

Adjust the tint of the screen.

Press + button the flesh tone color becomes greenish.

Press - button the flesh tone color becomes purplish.

NOTE: VIDEO mode only.

#### Color(Saturation)

Adjust the color of the screen.

Press + button to increase color depth.

Press - button to decrease color depth.

NOTE: VIDEO mode only

#### Noise Reduction

Adjust the noise reduction level.

#### Gamma selection

Select a display gamma, It's refer to the brightness performance curve of signal input. Choose from {Native} / {2.2} / {2.4} / {s gamma} / {D-image}.

NOTE: sRGB picture mode is standard and cannot be changed.

#### Color temperature

Select a color temperature for the image. A lower color temperature will have a reddish tint, while a higher color temperature gives off a more bluish tint.

CCT	10000° K	9300 ° K	7500 ° K	6500 ° K	5000 ° K	4000 ° K	3000 ° K
<b>X</b>	0.279 ± 0.030	0.283 ± 0.030	0.299 ± 0.030	0.313 ± 0.030	0.346± 0.030	0.382± 0.030	0.440± 0.030
<b>Y</b>	0.292 ± 0.030	0.298 ± 0.030	0.315 ± 0.030	0.329 ± 0.030	0.359± 0.030	0.384± 0.030	0.403± 0.030

## Color control

The color levels of red, green, and blue are adjusted by the color bars.

R: Red gain, G: Green gain, B: Blue gain.

## Smart picture

PQ setting

PC mode: {Standard} / {Highbright} / {sRGB}.

Video mode: {Standard} / {Highbright} / {Cinema}.

## Smart Contrast

Auto detect black data and white data on content and set suitable backlight.

Surface Ratio	Backlight Setting
5%-90%	(MaxBacklight-MinBacklight)* Surface Ratio/100
<5%	Min Backlight
>90%	Max Backlight

## Smart power

Smart Power control is not relative to brightness control:

- Initial setting Brightness  
70 (in the range from 0-100)  
Power consumption 70% of maximum power consumption
- Smart Power  
OFF: no adaptation  
MEDIUM: 80% of power consumption relative to current settings  
HIGH: 65% of power consumption relative to current settings
- Panel saving/Brightness ON: 40% of maximum power consumption  
The controls settings should only be visible on its own controls. It should not have secondary effects on other controls (brightness setting changes when smart power setting has changed).

## Overscan

Change the display area of the image.

ON: Set to display area about 95%.

OFF: Set to display area about 100%.

## Picture reset

Reset all settings in the Picture menu.

Select "Yes" and press "SET" button to restore to factory preset data.

Press "EXIT" button to cancel and then return to the previous menu.

## 6.2.2. Screen menu

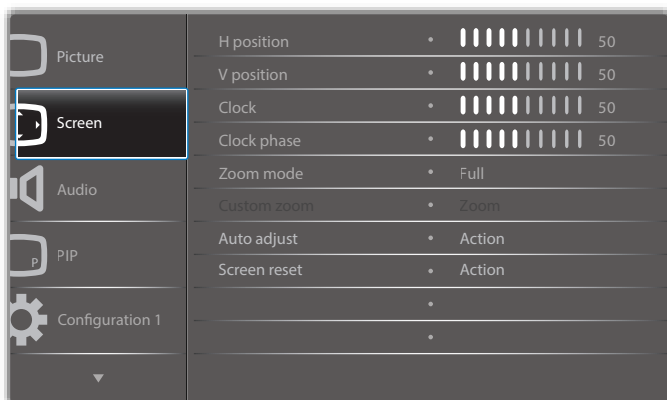

## H position

Control Horizontal Image position within the display area of the LCD.

Press + button to move screen to the right.

Press - button to move screen to the left.

## V position

Control Vertical Image position within the display area of the LCD.

Press + button to move screen upward.

Press - button to move screen downward.

## Clock

Press + button to expand the width of image on the screen to the right.

Press - button to narrow the width of image on the screen to the left.

NOTE:VGA input only.

## Clock phase

Improves focus, clarity and image stability by increasing or decreasing this setting.

NOTE:VGA input only

## Zoom mode

PC mode: {Full} / {4:3} / {1:1} / {16:9}/ {21:9}/ {Custom}.

Video mode: {Full} / {4:3} / {1:1} / {16:9}/ {21:9}/ {Custom}.

\*Zoom mode setting is defined by input. If input in multi-windows, the setting will apply for windows with the same input.





The INFO OSD will show the latest setting.

	<b>Full</b> This mode restores the correct proportions of pictures transmitted in 16:9 using the full screen display.
	<b>4:3</b> The picture is reproduced in 4:3 format and a black band is displayed on either side of the picture..
	<b>1:1</b> This mode displays the image pixel-by-pixel on screen without scaling the original image size.
	<b>16:9</b> The picture is reproduced in 16:9 format and a black band at the top and bottom.
	<b>21:9</b> The picture is reproduced in 21:9 format and a black band at the top and bottom.
	<b>Custom</b> Choose to apply the custom zoom settings in the Custom Zoom submenu.

## Custom zoom

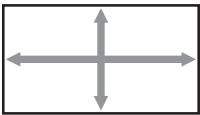
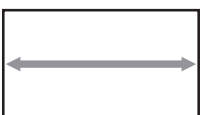
You can use this function to further customize the zoom settings to suit the image you want to display.

NOTE: This item is functional only when the {Zoom mode} is set to {Custom}.

	<b>Zoom</b> Expands the horizontal and vertical sizes of the image simultaneously.
	<b>H zoom</b> Expands the horizontal size of the image only.
	<b>V zoom</b> Expands the vertical size of the image only.
	<b>H position</b> Moves the horizontal position of the image left or right.
	<b>V position</b> Moves the vertical position of the image up or down.

### Auto adjust

Press "Set" to detect and adjust H position, V position, Clock, Phase automatically.

### Screen reset

Reset all settings in the **Screen** menu to factory preset values.

Select "Yes" and press "SET" button to restore the factory preset data.

Press "EXIT" button to cancel and then return to the previous menu.

### 6.2.3. Audio menu

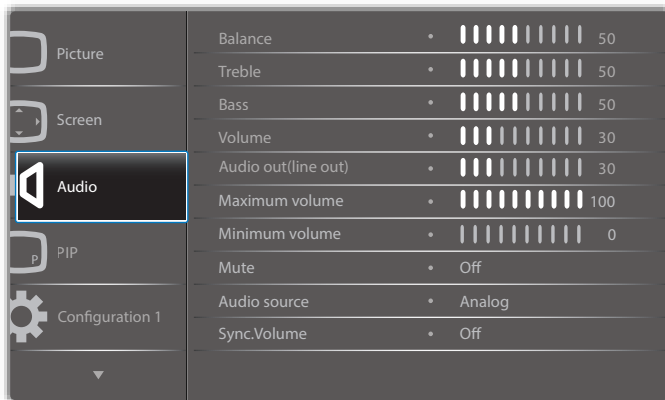

### Balance

Adjust to emphasize left or right audio output balance.

### Treble

Adjust to increase or decrease higher-pitched sounds.

### Bass

Adjust to increase or decrease lower-pitched sounds.

### Volume

Adjust to increase or decrease the audio output level.

### Audio out (line out)

Adjust to increase or decrease line out output level.

### Maximum volume

Adjust your own limitation for the maximum volume setting. This stops the volume from being played too loudly.

### Minimum volume

Adjust your own limitation for the minimum volume setting.

### Mute

Turn the mute function on/off.

### Audio source

Select the audio input source.

Analog: audio from audio input

Digital : audio from HDMI/DVI audio.

Displayport: audio from DP.

### Sync. Volume

Enable/disable audio out (line out) volume adjustability to sync with internal speakers volume, but PD Internal speaker sound will be forced to be mute.

### Audio reset

Reset all settings in the **Audio** menu to factory preset values.

### 6.2.4. PIP menu

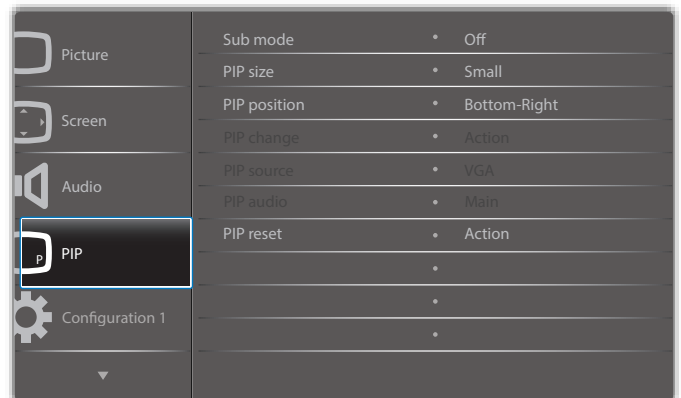

## Sub mode

Select the sub mode.

Choose from: {Off} / {PIP} / {PBP} / {Quick swap} / {Custom}.

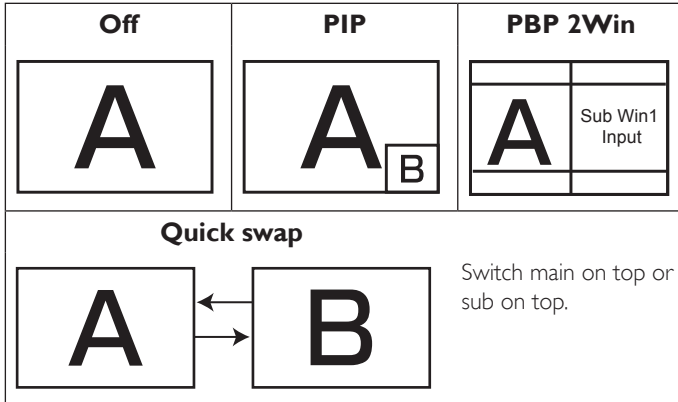

## PIP size

Select the size of the sub picture in the PIP (Picture-in-Picture) mode.

Choose from: {Small} / {Medium} / {Large}.

## PIP position

Select the position of the sub picture in the PIP (Picture-in-Picture) mode.

Choose from: {Bottom-Right} / {Bottom-Left} / {Top-Right} / {Top-Left}.

## PIP change

Exchange Main and PIP / PBP / Quick swap input signal.

## PIP source

Select the input signal for the sub picture.

## PIP audio

Select the audio source in the Sub mode.

- {Main} - Select audio from the main picture
- {Sub} - Select audio from the sub picture.

## PIP reset

Reset all settings in the PIP menu to factory preset values.

- The PIP function is available only for certain signal source combinations as shown in the table below.

	HDMI1	HDMI2	DVI	DisplayPort	VGA	Medoa Player	Browser	SmartCMS	PDF Reader	Custom
HDMI1	○	×	×	○	○	×	×	×	×	×
HDMI2	×	○	×	○	○	×	×	×	×	×
DVI	×	×	○	○	○*	×	×	×	×	×
DisplayPort	○	○	○	○	○	○	○	○	○	○
VGA	○	○	○*	○	○	○	○	○	○	○
Medoa Player	×	×	×	○	○	○	×	×	×	×
Browser	×	×	×	○	○	×	○	×	×	×
SmartCMS	×	×	×	○	○	×	×	○	×	×
PDF Reader	×	×	×	○	○	×	×	×	○	×
Custom	×	×	×	○	○	×	×	×	×	○

(○: PIP function available, ×: PIP function unavailable)

- The availability of the PIP function will also depend on the resolution of the input signal being used.

## 6.2.5. Configuration1 menu

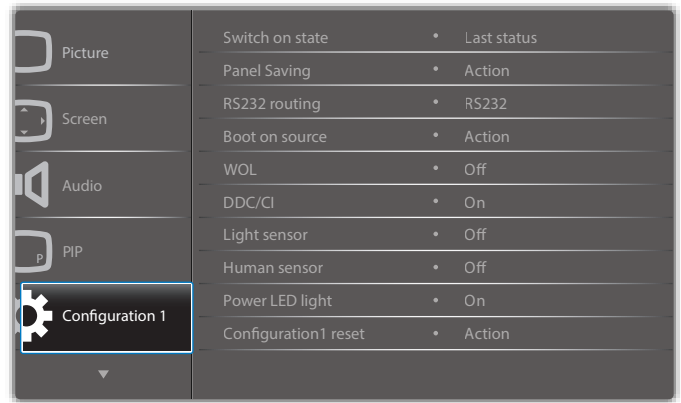

### Switch on state

Select the display status used for the next time you connect the power cord.

- {Power off} - The display will remain off when the power cord is connected to a wall outlet.
- {Forced on} - The display will turn on when the power cord is connected to a wall outlet.
- {Last status} - The display will return to the previous power status (on/off/standby) when removing and replacing the power cord.

### Panel saving

Choose to enable the panel saving functions and thus reduce the risk of "image persistence" or "ghost-imaging".

- {Brightness} - Select {On} and the image brightness will be reduced to an appropriate level. The Brightness setting in the Picture menu will be unavailable when selected.
- {Pixel shift} - Select the time interval ({Auto} / {10 ~ 900} Seconds / {Off}) for the display to slightly expand the image size and shift the position of pixels in four directions (up, down, left, or right).

### RS232 routing

Select the network control port.

Choose from: {RS232} / {LAN ->RS232}.

### Boot on source

Choose to select source when boot up.

Input: select input source when bootup.

Playlist: select playlist index for Media player, Browser, PDF player.

0: no play list. Same as switch source from OSD.

1~7: playlist number.

### WOL

Choose to turn on or off the wake on LAN function.

Choose from : {Off} / { On}

### DDC/CI

Choose to turn on or off the DDC/CI communication function.

Select {On} for normal use.

### Light sensor(require Philips accessory CRD41 External Sensor Box)

Choose to turn on or off backlight adjustment according to environment brightness.

Choose from : {Off} / { On}

## Human sensor(require Philips accessory CRD41 External Sensor Box)

The Human sensor can detect if people approach the display or not. The display will turn off backlight if it detects nothing in setting time. The display will return to backlight on when people approach the display..

The options are:

- {Off} (Default), {10 Min.}, {20 Min.}, {30 Min.}, {40 Min.}, {50 Min.}, {60 Min.}

## Power LED light

Choose to set power indication LED on or off.

Choose {On} for normal use.

## Configuration1 reset

Reset all settings in **Configuration1** menu to the factory preset values.

## Factory reset

Reset all settings in the OSD menus of {Picture}, {Screen}, {Audio}, {PIP}, {Configuration1}, {Configuration2}, and {Advanced option} to the factory preset values.

Android settings will also reset when factory reset.

Press [←] or [→] button to select {Reset}, and press [OK] button to do the reset.

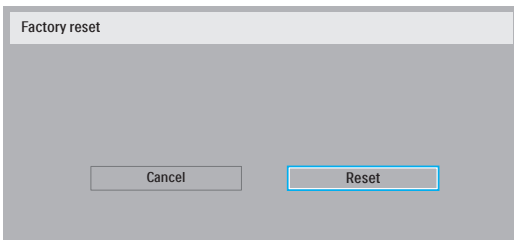

## 6.2.6. Configuration2 menu

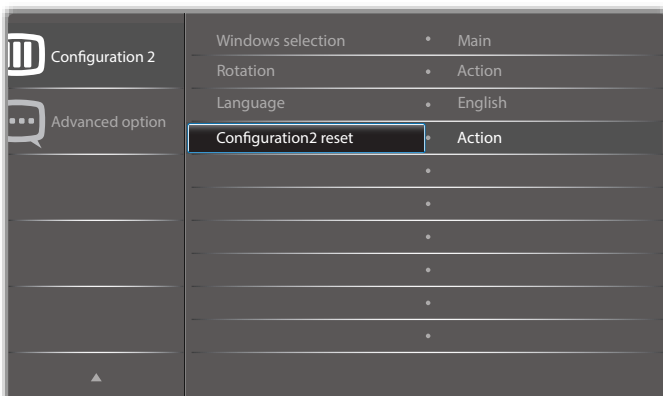
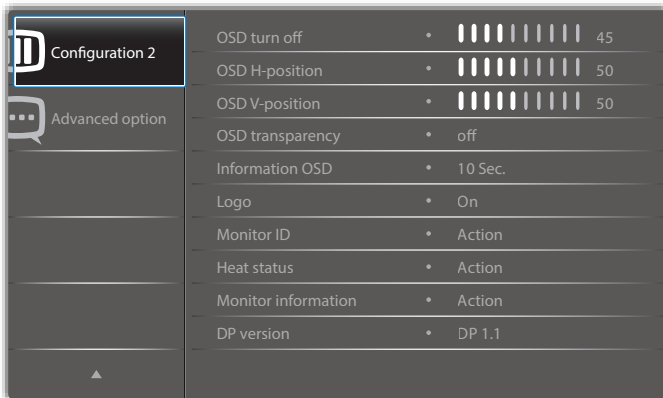

## OSD turn off

Set the period of time the OSD (on-screen display) menu stays on the screen.

The options are: {0 ~ 120} seconds.

\*{0} does not disappear automatically.

## OSD H-position

Adjust the horizontal position of the OSD menu.

## OSD V-position

Adjust the vertical position of the OSD menu.

## OSD Transparency

Adjust OSD transparency.

- {Off} - Transparency off.
- {1-100} - Transparency level 1-100.

## Information OSD

Set the period of time the information OSD is displayed on the upper right corner of the screen. The information OSD will display when input signal is changed.

The information OSD will remain on the screen with {Off} selection.

The options are: {1 ~ 60} seconds.

## Logo

Choose to enable or disable the picture of Logo when turn on your display.

The options are:

- {Off} (Default)
- {On}\*
- {User}\*\*

\*\* If Logo set to USER.

User logo does NOT support rotation function.

## Monitor ID

Set the ID number for controlling the display via the RS232C connection. Each display must have a unique ID number when multiple sets of this display are connected. Monitor ID number range is between 1 to 255.

The option are: {Monitor group} / {Tiling matrix} / {Auto ID}

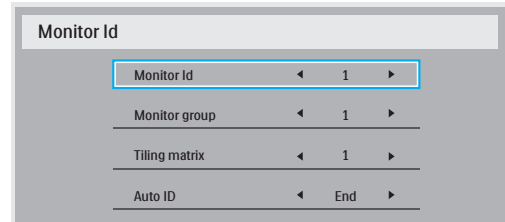

### • {Monitor group}

The options are: {Off} / {1-254}

- {Off} – {Monitor group} are not supported.
- {1-254} – {Monitor group} are supported. The default setting is 1.

### • {Tiling matrix}

Tiling matrix number range is between 1 to 15. 1 is default setting. The {Auto ID} setup function enables setting up {Monitor ID} of connected machine according to {Tiling matrix} settings.

Example: Tiling matrix sets as 4

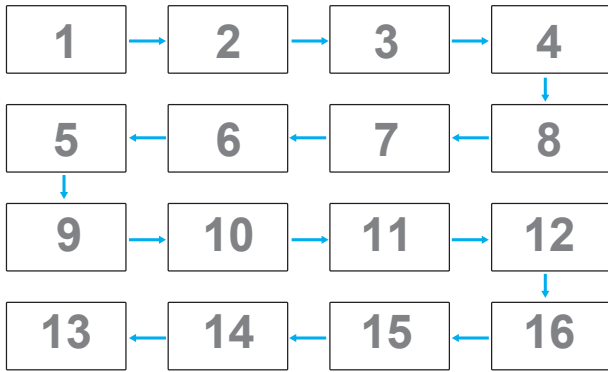

• **{Auto ID}**

The option are: {Start} / {End}.The default is {End}.

- Switch to Start option to set up IDs of machines backward from current one.
- Once the setup is completed, the option exits to End automatically.
- To use this function, serial connect all machines with RS-232 cable and set their Control ports to RS-232 too.

**Heat status**

This function allows you to check the thermal status at any time.

- A temperature-warning message will be shown on the screen if the temperature reaches 97°C (207°F).All key functions except [⏻] key will then be disabled.
- Once the temperature reaches 98°C (208°F), the display power will be shut down automatically.

**Monitor information**

Shows information about your display, including model number, serial number, operating hours and software version.

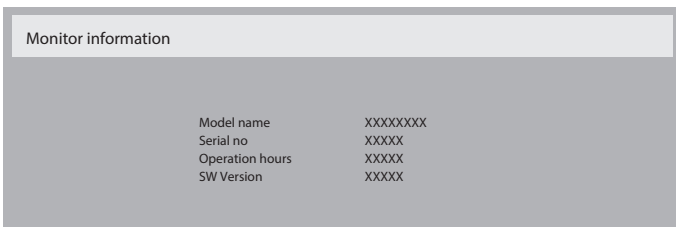

**DP version**

DisplayPort support mode.

The options are:

- **{DP 1.1} (Default)** : DP 1.1 single stream(clone mode)
- **{DP 1.2 SST}**: DP 1.2 Single stream(clone mode)
- **{DP 1.2 MST}**: DP 1.2 Multi-Stream

\*NOTE:

1. The DP version must be set the same for all daisy chain displays.
2. For 3840x2160, the dot clock timing should be 533MHz.
3. DP 1.1 not support 4K/60Hz timing.

**Window selection**

Select the window for adjusting setting.The selected window will be highlight green border.

Window selection will set to Main after power on.

The options are:

- **{Main}(Default), {PIP}**
- **[■]** Hot key for Window selection function.

**Rotation**

Set the rotation of Main/Sub/OSD

Auto Rotate :	Off/On	Default : Off
OSD Rotate :	Landscape/Portrait	Default : Landscape
Image Rotate:		
All :	Off/On	Default : Off
Main :	Off/On	Default : Off
Sub :	Off/On	Default : Off

Auto Rotate: {Off}, {On} when value is On,automatically detect whether the PD rotation, Off is set by OSD.

OSD Rotate: {Off}, {On} when value is on, OSD rotate 90 °, Off is restored.

All: {Off}, {On} when value is on, all Window screen rotate 90 °, Off the reference set individual window.

Main: {Off}, {On} when value is onn, Main window screen rotate 90 °, Off is restored.

Sub: {Off}, {On} when value is on, Sub1 Window screen rotate 90 °, Off is restored.

\* When the Main / Sub source is the same, rotation is given priority to with Sub.

\* Not suported De-Interlacing function in rotation mode.

**Language**

Select the language used in the OSD menu.

The options are: English/Deutsch/ 简体中文 /Français/Italiano/Español/ Русский/Польски/Türkçe/ 繁體中文 / 日本語 /Português/ العربية /Danish/ Svenska/Suomi/Norsk/Nederlands.

**Configuration2 reset**

Reset all settings in **Configuration2** menu to the factory preset values.

**6.2.7. Advanced option menu**

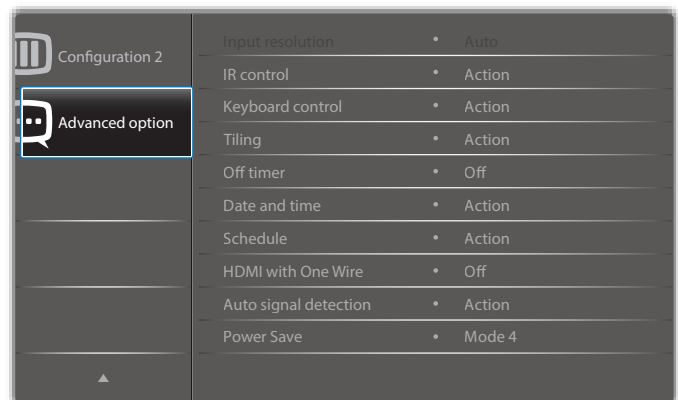

**Input resolution**

Set the resolution of theVGA input.This is only required when the display is unable to detect theVGA input resolution correctly.

NOTE: This item is functional for **VGA** input only.

The options are:

- **{1024x768 / 1280x768 / 1360x768 / 1366x768}**
- **{1400x1050 / 1680x1050}**
- **{1600x1200 / 1920x1200}**
- **{Auto}**: Determines the resolution automatically.

The selected settings will become effective after turning off the power and turning it on again.

## IR control

Select the operation mode of the remote control when multiple displays are connected via an RS232C connection.

- **{Normal}** - All displays can be operated normally by the remote control unit.
- **{Primary}** - Designate this display as the primary display for remote control operation. Only this display can be operated by the remote control. (In primary mode, IR key will always be processed regardless the monitor id/group settings).
- **{Secondary}** - Designate this display as the secondary display. This display can not be operated by the remote control, and will only receive the control signal from the primary display via the RS232C connection.
- **{Lock All} / {Lock all but Volume} / {Lock all but Power} / {Lock all except PWR & VOL}** - Lock the remote control function of this display. To unlock, press and hold the [**i**] INFO button on the remote control for 6 (six) seconds.

## Keyboard control

Choose to enable or disable the display keyboard (control buttons) function.

- **{Unlock}** - Enable the keyboard function.
- **{Lock All} / {Lock all but Volume} / {Lock all but Power} / {Lock all except PWR & VOL}** - Disable the keyboard function.

NOTE: "Keyboard Control Lock Mode" This function completely disables the access to all Keyboard Control functions. To enable or disable the keyboard control lock, press both [**+**] and [**Δ**] buttons and hold down continuously for more than 3 seconds.

## Tiling

With this function you can create a single large-screen matrix (video wall) that consists of up to 225 sets of this display (up to 15-sets on the vertical and 15-sets on the horizontal sides). This function requires a daisy-chain connection.

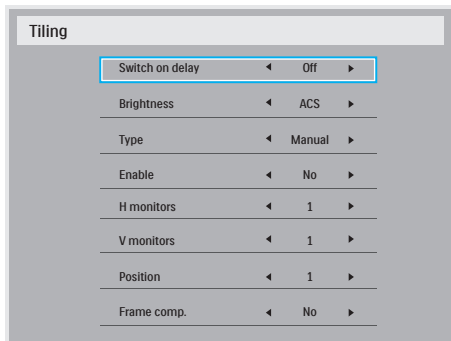

### Example: 2 x 2 screen matrix (4 displays)

H monitors = 2 displays  
V monitors = 2 displays

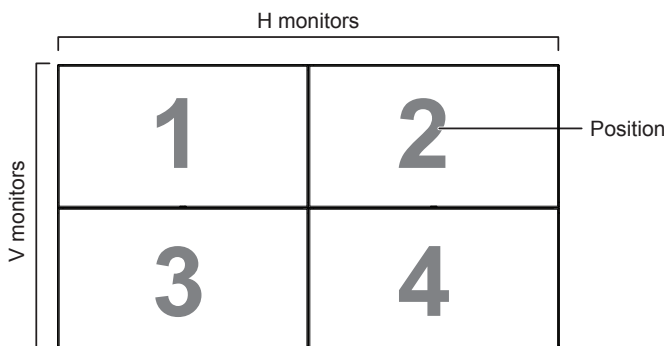

### Example: 5 x 5 screen matrix (25 displays)

H monitors = 5 displays  
V monitors = 5 displays

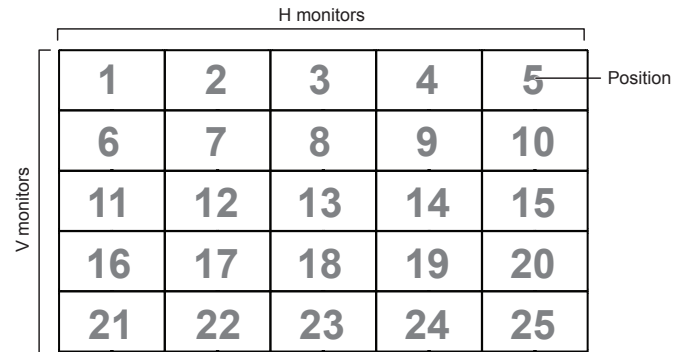

- **{Switch on delay}** - Set the power-on delaying time (in seconds). The default option **{Auto}** allows a sequential powering-on for each display by their ID number when multiple displays are connected. The options are: **{Off/Auto/2-255}**
- **Brightness: {Normal}/ {ACS}**  
**{Normal}**: Apply OSD brightness value (backlight)  
**{ACS}**: Apply brightness value (backlight) which is adjusted by MIC tool. The default value before adjustment is the same as OSD brightness value, e.g., 70)  
 Some brightness (backlight) settings cannot be adjusted by OSD. Please refer to Picture Menu Backlight setting priority.
- **Type: {Off}/ {SW Tool}/ {OSD Only}**
- **{Enable}** - Choose to enable or disable the Tiling function. If enabled, the display will apply the settings in **{H monitors}**, **{V monitors}**, **{Position}**, and **{Frame comp.}**.
- **{H monitors}** - Select the number of displays on the horizontal side.
- **{V monitors}** - Select the number of displays on the vertical side.
- **{Position}** - Select the position of this display in the screen matrix.
- **{Frame comp.}** - Choose to turn the frame compensation function on or off. If selected **{Yes}**, the display will adjust the image to compensate for the width of the display bezels in order to accurately display the image.

## Frame compensation - Yes

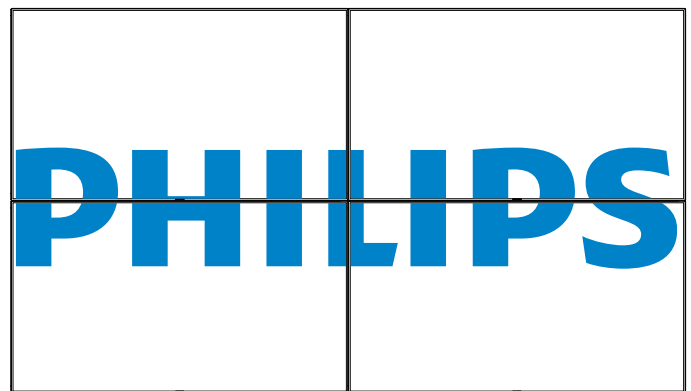



## Frame compensation - No

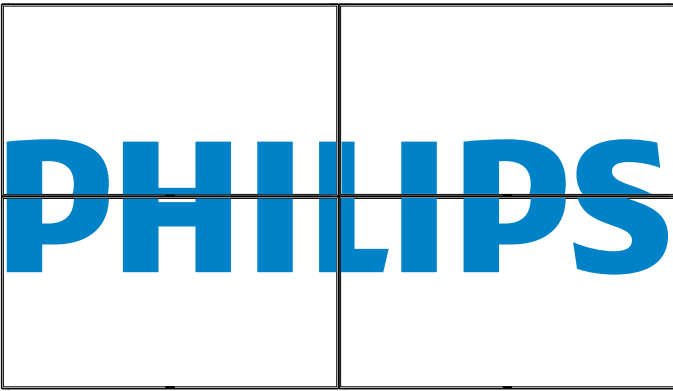

### Off Timer

Set automatically power off time (in hours).

### Date and time

Adjust the current date and time for the display's internal clock.

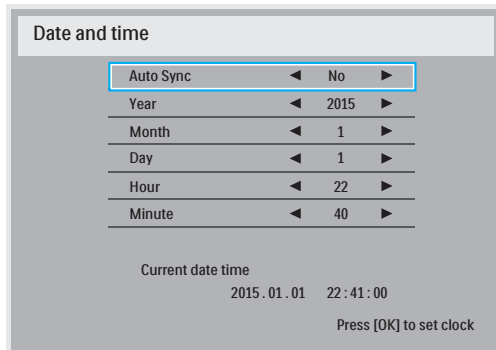

1. Press [OK] button to enter the submenu.
2. Press [▲] or [▼] button to toggle between {Year}, {Month}, {Day}, {Hour}, {Minute}.
3. Press [←] or [→] button to adjust settings.

### Schedule

This function allows you to program up to 7 (seven) different scheduled time intervals for the display to activate.

You can select:

- The time for the display to turn on and turn off.
- The days in a week for the display to activate.
- Which input source the display will use for each scheduled activation period.

NOTE: We recommend you to set up current date and time in the {Date and time} menu before using this function.

1. Press [OK] or [→] button to enter the submenu.

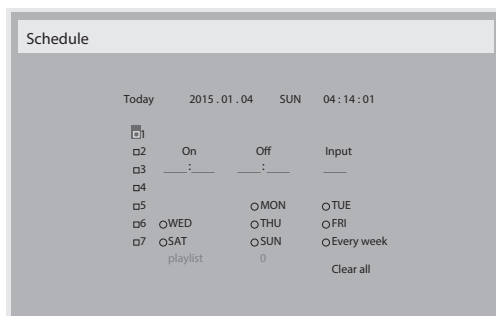

2. Press [▲] or [▼] button to select a schedule item (item number 1 ~ 7), and then press [OK] button to mark it the item number.

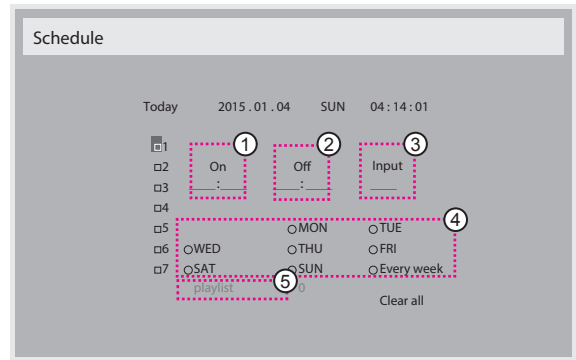

3. Press [←] or [→] button to select the schedule:
  - ① **Power-on** schedule: Press [▲] or [▼] button to set the hour and minute for the display to turn on.
  - ② **Power-off** schedule: Press [▲] or [▼] button to set the hour and minute for the display to turn off.  
Select or leave an empty "\_\_\_" for both the hour and minute slot if you do not want to use this power-on or power-off schedule.
  - ③ **Input-source** selection: Press [▲] or [▼] button to select an input source. If no input source is selected, the input source will remain the same as last selected.
  - ④ **Date** schedule: Press [←] button to select which day in a week this schedule item will be take effect, and then press the [OK] button.
  - ⑤ When **Input-source** select to **USB**, enable to access **playlist** setting:
4. For additional schedule settings, press [↶], then repeat the steps above. A check mark in the box next to the number of the schedule item indicates that the selected schedule is in effect.

### NOTES:

- If the schedules overlap, the scheduled power-on time takes priority over scheduled power-off time.
- If there are two schedule items programmed for the same time, the highest numbered schedule takes priority. For example, if schedule items #1 and #2 both set the display to power on at 7:00 AM and off at 5:00 PM, then only schedule item # 2 will take effect.

### HDMI with One Wire

CEC control.

- {Off} - Disable CEC.(Default)
- {On} - Enable CEC.

### Auto signal detection

Choose to let the display detect and display available signal sources automatically.

- {Off} - Once a signal is connected, it can only be selected manually.

If the selected input is no signal, set the display to display the image automatically according to the search order of each option.

The options are: {All} / {Failover}

- {All}: DP -> HDMI1 -> HDMI2 -> DVI -> VGA ->Media Player -> Browser -> SmartCMS -> PDF Reader -> Custom.
- {Failover}
  - Failover 1: User-defined setting. Default:HDMI 1.
  - Failover 2: User-defined setting. Default:HDMI 1.

- Failover 3: User-defined setting. Default:HDMI 1.
- Failover 4: User-defined setting. Default:HDMI 1.
- Failover 5: User-defined setting. Default:HDMI 1.
- Failover 6: User-defined setting. Default:HDMI 1.
- Failover 7: User-defined setting. Default:HDMI 1.
- Failover 8: User-defined setting. Default:HDMI 1.
- Failover 9: User-defined setting. Default:HDMI 1.
- Failover 10: User-defined setting. Default:HDMI 1.

### Power Save

Power save modes

Mode 1: [TCP off,WOL on, auto off]

DC off -> Power off. LED: Red.

Power Save -> Power off, LED: Red

Mode 2: [TCP off,WOL on, auto on/off]

DC off -> Power off, LED: Red.

Power Save -> Power Saving. LED: Orange. Can be wake up.

Mode 3: [TCP on,WOL off, auto on/off]

DC off -> Back light off, LED: Red

Power Save -> Back light off, LED: Orange. Can be wake up.

Mode 4: [TCP on,WOL off, no auto on/off]

DC off -> Back light off, LED: Red

Power Save -> Will not enter power save mode. show "no signal" only.

<u>Mode 3</u> DC OFF: Backlight Off only Power Save: Backlight Off only	<u>Mode 1(default)</u> DC OFF: Power Off Power Save: Power Off
<u>Mode 4</u> DC OFF: Backlight Off only Power Save: No signal(Backlight On)	<u>Mode 2</u> DC OFF: Power Off Power Save: Power Saving

Following table is the action for Android board with different power mode.

DC off/on: Press power button by RC

Power mode in OSD	Mode 1/2	Mode 3/4
DC off	shutdown	The current source APK(such as MediaPlayer, Browser, PDF, SmartCMS or Custom) will be closed.
DC on	Boot up	Android system reboots

### Scalar FW Update

Update scalar FW by USB.

### USB cloning

Copy PD settings from one set to another:

Import: Copy settings from file to display

Export: Copy PD settings into file.

\* Cloned data stores in android internal storage. User need to use APK to copy cloned data to another display.

### Advanced option reset

Reset all settings except {Date and Time} in the **Advanced option** menu to factory preset values.

1. Press [OK] or [▶] button to enter the submenu.
2. Press [←] or [▶] button to select {Reset} and press the [OK] button to restore settings to factory preset values.
3. Press the [↶] button or select {Cancel} and press the [OK] button to cancel and then return to the previous menu.

## 7. Supported Media Formats

### USB Multimedia Codec Formats

Video Decode						
Type	Video Codec	Container	Decode	Encode	Channel	Remark
MPEG1/2	MPEG1/2	MPEG program stream (.DAT, .VOB, .MPG, .MPEG) MPEG transport stream (.ts) MP4 (.mp4) AVI (.avi) MKV (.mkv)	V			Max Resolution: 1080P@60fps Max Bit Rats : 40Mbps
MPEG-4	MPEG4	MP4 (.mp4) AVI (.avi) MKV (.mkv)	V			Max Resolution: 1080P@60fps Max Bit Rats : 40Mbps
H.263	H.263	FLV (.flv) AVI (.avi)	V			Max Resolution: 1080P@60fps Max Bit Rats : 40Mbps
H.264	H.264	FLV (.flv) MP4 (.mp4) MPEG transport stream (.ts) ASF (.asf) WMV (.wmv) AVI (.avi) MKV (.mkv)	V			Max Resolution: 1080P@60fps Max Bit Rats : 135Mbps 4K2K@30fps
H.265	H.265	MP4 (.mp4) MPEG transport stream (.ts) MKV (.mkv)	V			Max Resolution: 4K2K@60fps Max Bit Rats : 100Mbps
GOOGLEVP8	VP8	MKV (.mkv) WebM (.webm)	V			Max Resolution: 1080P@30fps Max Bit Rats : 20Mbps
Motion JPEG	MJPEG	AVI (.avi) MP4 (.mp4) MKV (.mkv)	V			Max Resolution: 1920*1080 @30fps Max Bit Rats : 40Mbps

### Audio Decode

Type	Audio Codec	Container	Decode	Encode	Channel	Remark
MPEG Audio	MPEG1/2/2.5 Audio Layer1/2/3	MP3	V		2	Bit Rate: 8Kbps~320Kbps Sampling Rate: 16KHz~48KHz
Windows Media Audio	WMA Version 7, 8, 9,10 pro M0, 10Pro M1,M10 Pro M2	Decode:WMA	V		2	Bit Rate: 8Kbps~768Kbps Sampling Rate: 8KHz~96(M10)KHz Non-support LBR
AAC Audio	MAIN,ADIF ,ATDS Header AAC-LC and AAC-HE	File Format: AAC, M4A	V		5.1	Bit Rate: N/A Sampling Rate: 8KHz~48KHz

## Image Decode

Type	Image Codec	Photo	Decode	Encode	Channel	Remark
JPEG	JFIF file format 1.02	File Format: JPG, JPEG	V			Max Resolution: 7000 × 7000 The limitation of max resolution depends on DRAM
BMP	BMP	File Format: BMP	V			Max Resolution: 15360 × 8640 The limitation of max resolution depends on DRAM
PNG	PNG	File Format: PNG	V			Max Resolution: 15360 × 8640 The limitation of max resolution depends on DRAM

### NOTES:

- Sound or video may not work if the contents have a standard bit rate/frame rate above the compatible Frame/sec listed in the table above.
- Video content with a Bit rate or Frame rate larger than the rate specified in the table above can cause choppy video during playback.

## 8. Input Mode

### VGA/DVI timing support:

Item	Mode	Resolution	H.Freq. (KHz)	V.Freq. (Hz)
1	IBM VGA 10H	640x350	31.469	70.086
2	IBM VGA 12H	640x480	31.469	59.94
3	MACINTOSH	640x480	35	66.67
4	VESA	640x480	37.861	72.809
5	VESA	640x480	37.5	75
6	IBM VGA 3H	720x400	31.469	70.087
7	VESA	800x600	35.156	56.25
8	VESA	800x600	37.879	60.317
9	VESA	800x600	48.077	72.188
10	VESA	800x600	46.875	75.000
11	MACINTOSH	832x624	49.726	74.551
12	VESA Standard AddDMT	848x480	31	60.000
13	-	960x720	56.4	75.000
14	VESA	1024x768	48.363	60.004
15	VESA	1024x768	56.476	70.069
16		1152x864	53.986	59.985
17	VESA	1152x864	53.783	59.959
18		1152x864	63.851	70.012
19	VESA	1152x864	67.5	75.000
20	SUN WS	1152x900	61.846	66.004
21	-	1280x720	44.772	60.000
22	-	1280x720	52.5	70.000
23	CVT 2.3MA	1280 x768	47.776	59.870
24	CVT 2.3MA	1280 x768	60.289	74.893
25	CVT	1280x800	49.7	59.810
26	CVT	1280x800	62.8	74.930
27	VESA	1280x960	60	60.000
28	VESA	1280x1024	63.981	60.020
29	SUN WS	1280x1024	71.691	67.189
30	VESA	1280x1024	79.976	75.025
31	VESA Standard AddDMT	1360x768	47.712	60.015
32	VESA Standard AddDMT	1366x768	47.712	59.790
33	VESA-reduced blanking mode	1440x900	55.469	59.901
34	VESA	1440x900	55.935	59.887
35	VESA	1440x900	70.635	74.984
36	CVT-reduced blanking	1400x1050	64.744	59.948
37	CVT	1400x1050	82.278	74.867
38	CVT Red. Blanking	1600x900	55.54	60.000
39	VESA	1600x1200	75	60
40	CVT1.76MW	1680x1050	65.29	59.954
41	CVT1.76MW-R	1680x1050	64.674	59.883
42	CVT 2.3MA-R	1920x1080	66.587	59.934
43	VESA Standard VDMTREV	1920x1080	67.5	60.000
44	CVT1960H	1920x1080	67.1584	59.963
45	VSC1960H	1920x1080	67.08	60
46	CVT 2.3MA-R	1920x1200	74.038	59.950

Video Timing support(HDMI/DVD HD/DVI)

Item	Mode	Resolution	Comment
1	60Hz	480i	except DVI
2		480p	
3		720p	
4		1080i	
5		1080p	
6	50Hz	576i	except DVI
7		576p	
8		720p	
9		1080i	
10		1080p	

- The PC text quality is optimum in FHD 1920 × 1080, 60Hz.
- Your PC display screen might appear different depending on the manufacturer (and your particular version of Windows).
- Check your PC instruction book for information about connecting your PC to a display.
- If a vertical and horizontal frequency-select mode exists, select 60Hz (vertical) and 31.5KHz (horizontal). In some cases, abnormal signals (such as stripes) might appear on the screen when the PC power is turned off (or if the PC is disconnected). If so, press the **[INPUT]** button to enter the video mode. Also, make sure that the PC is connected.
- When horizontal synchronous signals seem irregular in RGB mode, check PC power saving mode or cable connections.
- The display settings table complies to the IBM/VESA standards, and based on the analog input.
- The DVI support mode is regarded as same to the PC support mode.
- The best timing for the vertical frequency to each mode is 60Hz.
- YCbCr 444 BT2020 Non-const is not supported.

## 9. Pixel Defect Policy

We strive to deliver the highest quality products and use some of the industry's most advanced manufacturing processes whilst practicing stringent quality control. However, pixel or sub-pixel defects on the PDP / TFT panels used in Plasma- & LCD- displays are sometimes unavoidable. No manufacturer can guarantee that all panels will be free from pixel defects, but Philips guarantees that any Plasma- & LCD- displays with an unacceptable number of defects will be repaired during the warranty period in line with your local guarantee conditions.

This notice explains the different types of pixel defects and defines the acceptable defect level for the LCD screen. In order to qualify for repair under warranty, the number of pixel defects must exceed a certain level as shown in the reference table. If the LCD screen is within specification a warranty exchange / claim back will be refused. Additionally, because some types or combinations of pixel defects are more noticeable than others, Philips sets even higher quality standards for those.

### 9.1. Pixels and Sub-Pixels

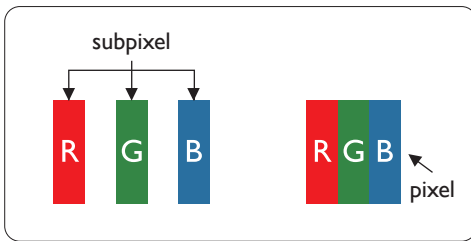

A pixel, or picture element, is composed of three sub-pixels in the primary colors of red, green and blue. Many pixels together form an image. When all sub-pixels of a pixel are lit, the three colored sub-pixels together appear as a single white pixel. When all are dark, the three colored sub-pixels together appear as a single black pixel. Other combinations of lit and dark sub-pixels appear as single pixels of other colors.

### 9.2. Types of Pixel Defects + Dot Definition

Pixel and sub-pixel defects appear on the screen in different ways. There are three categories of pixel defects and several types of sub-pixel defects within each category.

#### Dot definition = What is a defective "Dot"?

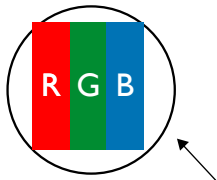

One or more defective, adjacent sub-pixel are defined as one "dot". The no. of defective sub-pixels are not relevant to define a defective dot. This means that a defective dot can consist of one, two or three defective sub-pixels which can be dark or lit.



One dot = One Pixel; consists of three sub-pixels of Red, Green, and Blue.

### 9.3. Bright Dot Defects

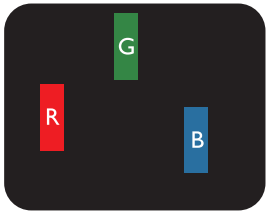
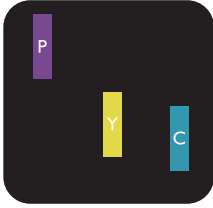
Bright dot defects appear as pixels or sub-pixels that are always lit or "on". These are the examples of bright dot defects:

 <p>One lit red, green or blue sub pixel</p>	 <p>Two adjacent lit sub pixels:            Red + Blue = Purple            Red + Green = Yellow            Green + Blue = Cyan (Light Blue)</p>	 <p>Three adjacent lit sub pixels (one white pixel)</p>
---	--	--

## 9.4. Dark Dot Defects

Black dot defects appear as pixels or sub-pixels that are always dark or "off". These are the examples of black dot defects:

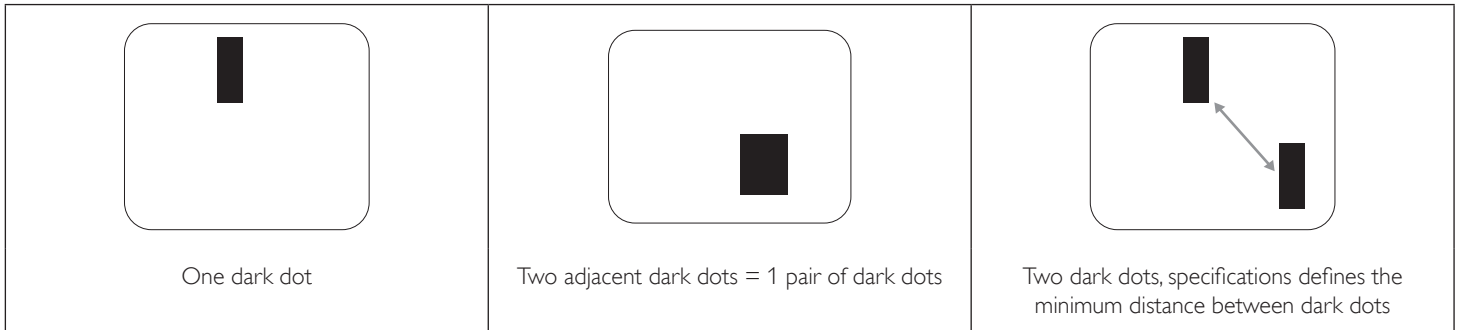

## 9.5. Proximity of Pixel Defects

Because pixel and sub-pixels defects of the same type that are nearby one another may be more noticeable, Philips also specifies tolerances for the proximity of pixel defects. In the table below you can find specifications about:

- Allowed amount of adjacent dark dots = (adjacent dark dots = 1 pair of dark dots)
- Minimum distance between dark dots
- Total no. of all defective dots

## 9.6. Pixel Defect Tolerances

In order to qualify for repair due to pixel defects during the warranty period, a PDP / TFT panel in a Philips Plasma / LCD- display must have pixel or sub-pixel defects exceeding the tolerances listed in the following table.

BRIGHT DOT EFFECT	ACCEPTABLE LEVEL
1 lit sub pixel	2
BLACK DOT EFFECT	ACCEPTABLE LEVEL
1 dark sub pixel	10
TOTAL DOT DEFECTS OF ALL TYPES	12

NOTE: \* 1 or 2 adjacent sub pixel defects = 1 dot defect

## 9.7. MURA

Dark spots or patches may occasionally appear on some liquid crystal display (LCD) panels. This is known within the industry as Mura, which is a Japanese term for "unevenness." It is used to describe an irregular pattern or area in which uneven screen uniformity appears under certain conditions. Mura is a result of the deterioration of the liquid crystal alignment layer and is most commonly caused by long-term operation under high ambient temperatures. It is an industry- wide phenomenon and Mura is not repairable. It is also not covered by our warranty terms.

Mura has been around since the introduction of LCD technology and with screens getting bigger and in operation 24/7, many displays are running in low light conditions. This all adds to the possibility of Mura affecting displays.

### HOW TO SPOT MURA

There are many symptoms of Mura and also multiple causes. Several of these are listed below:

- Impurities or foreign particles in the crystal matrix
- Uneven distribution of LCD matrix during manufacturing
- Non-uniform luminance distribution of the backlight
- Panel assembly induced stress
- Flaws within the LCD cells
- Thermal induced stress - high temperature operation over long periods of time

### HOW TO AVOID MURA

Although we can not guarantee the complete eradication of Mura every time, in general the appearance of Mura can be minimized by these methods:

- Lower the backlight brightness
- Use a screen saver
- Reduce the ambient temperature around the unit



## 10. Cleaning and Troubleshooting

### 10.1. Cleaning

#### Caution When Using the Display

- Do not bring your hands, face or objects close to the ventilation holes of the display. The top of the display is usually very hot due to the high temperature of exhaust air being released through the ventilation holes. Burns or personal injuries may occur if any body parts are brought too close. Placing any object near the top of the display could also result in heat related damage to the object as well as the display itself.
- Be sure to disconnect all cables before moving the monitor. Moving the monitor with its cables attached may damage the cables and thus cause fire or electric shock.
- Disconnect the power plug from the wall outlet as a safety precaution before carrying out any type of cleaning or maintenance procedure.

#### Front Panel Cleaning Instructions

- The front of the display has been specially treated. Wipe the surface gently using only a cleaning cloth or a soft, lint-free cloth.
- If the surface becomes dirty, soak a soft, lint-free cloth in a mild detergent solution. Wring the cloth to remove excess liquid. Wipe the surface of the display to remove dirt. Then use a dry cloth of the same type to dry.
- Do not scratch or hit the surface of the panel with fingers or hard objects of any kind.
- Do not use volatile substances such as insect sprays, solvents and thinners.

#### Cabinet Cleaning Instructions

- If the cabinet becomes dirty, wipe the cabinet with a soft, dry cloth.
- If the cabinet is extremely dirty, soak a lint-free cloth in a mild detergent solution. Wring the cloth to remove as much moisture as possible. Wipe the cabinet. Use another dry cloth to wipe over until the surface is dry.
- Do not use solution that contains oil to clean the plastic parts. Such product damage the plastic parts and void the warranty.
- Do not allow any water or detergent to come into contact with the surface of the display. If water or moisture gets inside the unit, operating problems, electrical and shock hazards may result.
- Do not scratch or hit the cabinet with fingers or hard objects of any kind.
- Do not use volatile substances such as insect sprays, solvents and thinners on the cabinet.
- Do not place anything made from rubber or PVC near the cabinet for any extended periods of time.

## 10.2. Troubleshooting

Symptom	Possible Cause	Remedy
No picture is displayed	<ol style="list-style-type: none"> <li>1. The power cord is disconnected.</li> <li>2. The main power switch on the back of the display is not switched on.</li> <li>3. The selected input has no connection.</li> <li>4. The display is in the standby mode.</li> </ol>	<ol style="list-style-type: none"> <li>1. Plug in the power cord.</li> <li>2. Make sure that the power switch is switched on.</li> <li>3. Connect a signal connection to the display.</li> </ol>
Interference displayed on the display or an audible noise is heard	Caused by surrounding electrical appliances or fluorescent lights.	Move the display to another location to see if the interference is reduced.
Color is abnormal	The signal cable is not connected properly.	Make sure that the signal cable is attached firmly to the back of the display.
Picture is distorted with abnormal patterns	<ol style="list-style-type: none"> <li>1. The signal cable is not connected properly.</li> <li>2. The input signal is beyond the capabilities of the display.</li> </ol>	<ol style="list-style-type: none"> <li>1. Make sure that the signal cable is attached firmly.</li> <li>2. Check the video signal source to see if it is beyond the range of the display. Please verify its specifications with this display's specification section.</li> </ol>
Display image doesn't fill up the full size of the screen	<ol style="list-style-type: none"> <li>1. The zoom mode is not set correctly.</li> <li>2. Scan Mode may be set incorrectly to underscan.</li> <li>3. If the image exceeds the screen size, Scan Mode may need to be set to Underscan.</li> </ol>	Use the Zoom mode or Custom zoom function in the Screen menu to fine tune display geometry and time frequency parameter.
Can hear sound, but no picture	Source signal cable is connected improperly.	Make sure that both video inputs and sound inputs are correctly connected.
Can see picture but no sound is heard	<ol style="list-style-type: none"> <li>1. Source signal cable is connected improperly.</li> <li>2. Volume is turned all the way down.</li> <li>3. {Mute} is turned on.</li> <li>4. No external speaker is connected.</li> </ol>	<ol style="list-style-type: none"> <li>1. Make sure that both video inputs and sound inputs are connected correctly.</li> <li>2. Press <b>[+]</b> or <b>[-]</b> button to hear sound.</li> <li>3. Switch MUTE off by using the <b>[MUTE]</b> button.</li> <li>4. Connect external speakers and adjust the volume to a suitable level.</li> </ol>
Some picture elements do not light up	Some pixels of the display are off.	This display is designed using an extremely high level of precision technology; however, sometimes some pixels of the display may not display. This is not a malfunction..
After-Images can still be seen on the display after the display is powered off. (Examples of still pictures include logos, video games, computer images, and images displayed in 4:3 normal mode)	A still picture is displayed for an over extended period of time	Do not allow a still image to be displayed for an extended period of time as this can cause a permanent after-image to remain on the display.

<p><b>How to setup the settings in the menu to control all the monitors at the same time and individually via RC?</b></p>	<p>Daisy chained by RS232 and no IR cable</p>	<p>1.The first display sets as "Primary" on OSD (Advanced option/IR control item), others set as "Secondary".</p> <p>2.The setup OSD will show on top left side of the display.(Toggle MENU will show again if it disappear)</p> <p>3. Default setting: ID NO: 0, GP NO: 0, this setting can control all displays by IR.</p> <p>The "+", "-" can change "ID NO" to control signal display by "Monitor ID".</p> <p>The "UP", "DOWN" can change "GP NO" to control multi-display by "Group ID".</p> <p>*The first display is always controlled by IR.</p>
<p><b>How is the RC working?</b></p>	<p>Daisy chain: no connection of RS232 and IR cable</p>	<p>No setting is required. Connect with IR cables and control by IR.</p> <p>*This may cause out-of-synchronism phenomenon. It is suggested to use the above settings with RS-232 cable.</p>

# 11. Technical Specifications

## Display:

Item	Specifications			
	32BDL4051D	43BDL4051D	49BDL4051D	55BDL4051D
Screen Size (Active Area)	800.1 mm / 31.5 inches	1080 mm / 42.5 inches	1232 mm / 48.5 inches	1387 mm / 54.6 inches
Aspect Ratio	16:9	16:9	16:9	16:9
Number of pixels	1920 (H) × 1080 (V)	1920 (H) × 1080 (V)	1920 (H) × 1080 (V)	1920 (H) × 1080 (V)
Pixel pitch	0.36375 (H) × 0.36375 (V) [mm]	0.4902 (H) × 0.4902 (V) [mm]	0.55926 (H) × 0.55926 (V) [mm]	0.630 (H) × 0.630 (V) [mm]
Displayable colors	16.7 million colors	16.7 million colors	16.7 million colors	16.7 million colors
Brightness (typical)	450 cd/m <sup>2</sup>	450 cd/m <sup>2</sup>	450 cd/m <sup>2</sup>	450 cd/m <sup>2</sup>
Contrast ratio (typical)	1100:1	1100:1	1100:1	1100:1
Viewing angle	178 degrees	178 degrees	178 degrees	178 degrees

## In/Out Terminals:

Item		Specifications
Speaker Output	Internal Speakers	10W (L) + 10W (R) [RMS]/8Ω 82 dB/W/M/160 Hz ~ 13 KHz
Audio Output	3.5mm phone jack × 1	0.5V [rms] (Normal) / 2 Channel (L+R)
Audio Input	3.5mm phone jack × 1	0.5V [rms] (Normal) / 2 Channel (L+R)
RS232	2.5mm Phone jack × 2	RS232 in / RS232 out
RJ-45	RJ-45 Jack × 1 (8 pin)	1000 baseT
HDMI Input	HDMI Jack × 2 (Type A) (19 pin)	Digital RGB: TMDS (Video + Audio) MAX: Video - 720p, 1080p, 3840 × 2160/30 Hz Audio - 48 KHz/ 2 Channel (L+R) Supports LPCM only
Displayport in/out	Displayport Jack × 2 (20 pin)	Digital RGB: TMDS (Video + Audio) MAX: Video - 720p, 1080p, 3840 × 2160/60 Hz Audio - 48 KHz / 2 Channel (L+R) Supports LPCM only
DVI-I (DVI-D & VGA) Input	DVI-I jack	Digital RGB: TMDS (Video) Analog RGB: 0.7V [p-p] (75Ω), H/CS/V: TTL (2.2kΩ), SOG: 1V [p-p] (75Ω) MAX: 720p, 1080p, 1920 × 1080/60 Hz (WUXGA)
DVI-I (DVI-D & VGA) Output	DVI-I Jack × 1 (29 pin)	Digital RGB: TMDS (Video) Analog RGB: 0.7V [p-p] (75Ω), H/CS/V: TTL (2.2kΩ), SOG: 1V [p-p] (75Ω) MAX: 720p, 1080p, 1920 × 1080/60 Hz (WUXGA)
SD card	Micro SD card	Support to 128GB
OTG	Mini USB	Service only
USB Input	USB2.0 TypeA ×1 USB3.0 TypeA ×1	USB2.0 USB3.0

**General:**

Item	Specifications			
	32BDL4051D	43BDL4051D	49BDL4051D	55BDL4051D
Power Input	100 - 240V~, 50 - 60Hz	100 - 240V~, 50 - 60Hz	100 - 240V~, 50 - 60Hz	100 - 240V~, 50 - 60Hz
Power Consumption (Max)	110 W	120 W	130 W	150 W
Power Consumption (typ.)	60 W	65 W	75 W	85 W
Power Consumption (Standby mode & Off mode)	<0.5 W	<0.5 W	<0.5 W	<0.5 W
Dimensions (Without Stand) [W x H x D]	724.8 x 424.3 x 64.1 mm	965.0 x 559.3 x 45.5 mm	1097.6 x 633.9 x 45.5 mm	1233.4 x 710.3 x 45.5 mm
Weight (Without Stand)	6.15 Kg	10.4 Kg	14.8 Kg	18.0 Kg
Weight (With Stand)	8.25 Kg	14.5 Kg	18.9 Kg	22.1 Kg
Gross Weight	8.50 Kg	14.7 Kg	20.0 Kg	25.4 Kg
Energy Efficiency Class	B	A	A	A <sup>+</sup>
Visible Screen Size	800.1 mm / 31.5 inches	1080 mm / 42.5 inches	1232 mm / 48.5 inches	1387 mm / 54.6 inches
On Mode Power Consumption (W)	55 W	65 W	75 W	85 W
Annual Energy Consumption (kWh)	81 kWh	95 kWh	110 kWh	124 kWh
Standby mode Power Consumption (W)	0.50 W	0.50 W	0.50 W	0.50 W
Off Mode Power Consumption (W)	0 W	0 W	0 W	0 W
Display Resolution (Pixels)	1920 x 1080	1920 x 1080	1920 x 1080	1920 x 1080
Network Standby (W)	2 W	2 W	2 W	2 W

**Environmental Condition:**

Item		Specifications
Temperature	Operational	0 ~ 40°C
	Storage	-20 ~ 60°C
Humidity	Operational	20 ~ 80% RH (No condensation)
	Storage	5 ~ 95% RH (No condensation)
Altitude	Operational	0 ~ 3,000 m
	Storage / Shipment	0 ~ 9,000 m



2020 © TOP Victory Investments Ltd. All rights reserved.

This product has been manufactured by and is sold under the responsibility of Top Victory Investments Ltd., and Top Victory Investments Ltd. is the warrantor in relation to this product. Philips and the Philips Shield Emblem are registered trademarks of Koninklijke Philips N.V. and are used under license.

Specifications are subject to change without notice.