

120 SP2(SC2) 120 CP4(CC3)/CP5(CC4)/CP6(CC5)/CP7(CC6)

Type/Tipo:

227-4S + 227-6S + 227-4C + 227-2C + 227-1C + 227-1CF

**Before operating, please read the Operating Manual!
Before operating, please read the Operating Instructions!**

Veillez lire le mode d'emploi avant la mise en service!

Leer las instrucciones de uso antes de la puesta en servicio!

Antes de pôr a máquina em funcionamento leia as instruções de operação!



Operating Manual

(page 2-4)

USA

Operating Instructions

(page 5-7)

GB

Instructions d'opération

(page 8-10)

F

Instrucciones de uso

(página 11-13)



E

Instruções de Operação



(página 14-16)

P





IMPORTANT SAFETY NOTES

-  << The machine may not be operated by more than one person at any given time! The machine was designed for safe operation by "one person only".
-  << During the shredding process no other work may be performed on the machine (for example cleaning, etc.)!
-  << The machine is **not a toy**, and is **not suitable for use by children!** The overall technical safety concept of this machine (dimensions, feed openings, emergency shutdown devices etc.) does not provide for any guarantee regarding hazard-free operation by children.

-  << **Danger of injury!** Keep all loose articles of clothing, ties, jewelry, long hair or other loose objects away from opening!

-  << **Danger of injury!** Never insert fingers into opening!
-  << In case of danger switch the machine off with the mains switch, or unplug the machine!
-  << Always unplug the machine from the mains power supply before opening the machine! Repairs may only be performed by trained personnel!

Special materials

Model \ Symbol				
120SP2 (SC2)-3,8				X
120SP2 (SC2)-5,8				X
120CP4 (CC3)				X
120CP5 (CC4)				X
120CP6 (CC5)	X		X	X
120CP7 (CC6)	X	X	X	X

X = not applicable for shredding

 **Warning:**
Moving parts can crush and cut!

 **Warning:**
Electrical Hazard!

INITIATION

AREA OF APPLICATION:
The **intimus 120 SP2(SC2)/CP4(CC3)/CP5(CC4)/CP6(CC5)/CP7(CC6)** data shredder is a machine used for shredding general documents.

 **Generally the machine may only be used to shred paper (deviations see table below "special materials")!** Shredding of other types of data carriers may lead to injuries (for example due to splintering of hard materials etc.) and damage to the machine (for example destruction of the cutter etc.).

INSTALLATION:





- Unpack the machine and put it together.
- Fit the plastic bag onto the bag frame.
- Attach the Power Cord to the Power Connection on the machine and plug into an AC outlet (1) (Fig. 2) (For information on the right fuse for the plug see "TECHNICAL DATA").

 **The socket outlet shall be installed near the equipment and shall be easily accessible!**
Only operate the machine in enclosed rooms at temperatures between 10°C and 25°C!
Keep enough distance to the surroundings when installing the machine.

OPERATION

CONTROLS:

- 1 = Mains plug (Fig. 2)**
When the machine is first plugged in it is not on.
- 2 = Function buttons (Fig. 1)**
"Ready" / "Off" / "Stop"
This button has three functions:
 - a) "Ready"
The machine changes to "Ready" if you press this button briefly. At the same time the integral LED display  comes on.
 - b) "Off"
The machine switches off if it is in the "Ready" mode and the button is held down for about 3 seconds.
Note: The machine switches off automatically if it is not used for about 5 minutes.
 - c) "Stop"
If you press this button briefly when the cutters are running they switch off and stop.

- 3 = Forwards button (Fig. 1)**
This button has two functions:
 - a) If this button is pressed briefly, the cutting mechanism runs forwards for a few seconds, e.g. to remove remaining material from the cutting mechanism. At the same time the integrated LED display  lights up.
 - b) If this button is pressed and held for approx. two secs., the cutting mechanism runs forwards continually and materials to be shredded can be fed into the machine. At the same time the integrated LED display  lights up.
- 4 = Reverse button (Fig. 1)**
If you press this button the cutters run backwards for a short time. At the same time the integral LED display  comes on.
- 5 = Light barrier (Forward motion) (Fig. 3)**
The shredding procedure starts as soon as material is fed into the feed slot. At the same time the integral forward button LED display  comes on.

- 6 = Control display (Fig. 1)**
"Material jam in machine" / "Light barrier covered when door opens or when machine turned on"
For the procedures see the relevant description under the "MALFUNCTION" section.
 - a) "Material jam in machine"
Comes on when too much material has been fed into the cutters. The cutters jam, then run in reverse for a short time and stop. The motor switches off.
 - b) "Light barrier covered when door open"
Comes on when there is still material in the feed slot when the door is opened. The cutters stop. The motor switches off.
 - c) "Light barrier covered when machine turned on"
Comes on when there is still material in the feed slot when the machine is switched on.

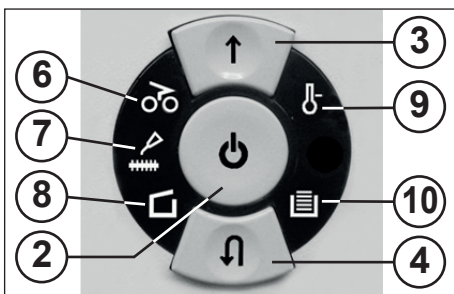

Fig. 1



Fig. 2

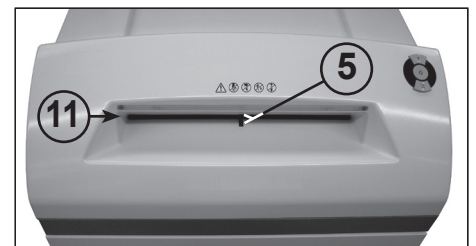

Fig. 3

OPERATION

CONTROLS:

7 = Control display (Fig. 1)
"Oil cutters"

Comes on when the cutters in the cross cut version must be oiled. The lubrication procedure must be acknowledged on the reverse button (4) (see description in "CUTTER MAINTENANCE").

8 = Control display (Fig. 1)
"Door open"/"Door malfunction"

a) "Door open"

Comes on if the door on the lower part of the machine is opened. The machine switches off automatically and cannot be started as long as the door remains open.

b) "Electrical fault"

Flashes when there is an electrical fault in the door sensor. The machine switches off. Please contact your dealer.

9 = Control display (Fig. 1)

To find out what to do see the relevant description under the "MALFUNCTION" section.

"Electrical fault"

Flashes when there is an electrical fault inside the control board. At the same time the function button (2) LED display  flashes. The machine switches off. Please contact your dealer.

10 = Control display (Fig. 1)

"Receptacle / Paper collection bag full"

Comes on when the receptacle / paper collection bag is full and must be emptied. The cutting unit for reducing paper switches off.

11 = Paper feed slot (Fig. 3)

12 = Receptacle (Fig. 4)

13 = Paper collection bag (Fig. 4)

14 = Oil reservoir (Fig. 4)



The shredder may not be used as a step ladder or as a seat. Danger of falling due to breakage!

SWITCHING THE MACHINE ON:

Proceed as follows to switch the machine to "Ready":

- Press the function button (2) briefly.
- The function button (2) LED display  comes on for "Ready".
- The machine can be loaded.

MATERIAL FEED:

Feed **paper** into the cutting mechanism through the paper feed slot (11) (Fig. 3).

The machine automatically switches to forwards running, draws the material in and automatically switches off after shredding.

Note: For shredding transparent films, the machine must be manually switched to forwards running (press and hold the forwards button (3) for approx. 2 secs.).

By briefly pressing the function button (2) (Stop function), the shredding process can be stopped at any time. To continue, press and hold the forwards button (3) for approx. 2 secs.

If the machine is not used for a period of approx. 5 mins., it automatically switches off.





Never feed the shredder with a quantity of material exceeding the maximum indicated. Refer to the TECHNICAL DATA section!



Should the machine become overloaded, follow the instructions under "MATERIAL JAM IN MACHINE" under "MALFUNCTIONS".

EMPTYING THE RECEPTACLE / PAPER COLLECTION BAG / (Fig. 4):



If the receptacle / paper collection bag is full the machine switches off. The control display  (10) comes on. Proceed as follows:

- Open the door. The control display  (8) comes on. If there is still material in one of the feed slots, the control display  (6) also comes on.

Receptacle (12):

- Pull out the receptacle from the lower part of the housing and empty the contents. The control display  (10) goes out.
- Slide the emptied receptacle (12) back into the lower part of the housing and close the door. The control display  (8) goes out.
- If the control display  (6) comes on, press the forward button (3) briefly. The remaining material in the feed slot is shredded and the display go out.

Paper collection bag (13):

- Take the collection bag and the frame out of the bottom part of the housing. Remove the bag and dispose of the contents. The control display  (10) goes out.
- Fit the emptied bag onto the bag frame and insert the bag and the frame into the bottom part of the housing again. Close the door. The control display  (8) goes out.
- If the control display  (6) comes on, press the forward button (3) briefly. The remaining material in the feed slot is shredded and the display go out.

Note: The machine will only run if the door is closed.

DYNAMIC LOAD DISPLAY:

To prevent a material jam and thus ensure a continual, effective destruction of the data carriers, the current load level of the motor is displayed during the shredding process by a coloured, diffuse light in the feed slot as follows:

Green light:	load < 50%
Yellow light:	load 50 - 75%
Red light:	load 75 - 100%

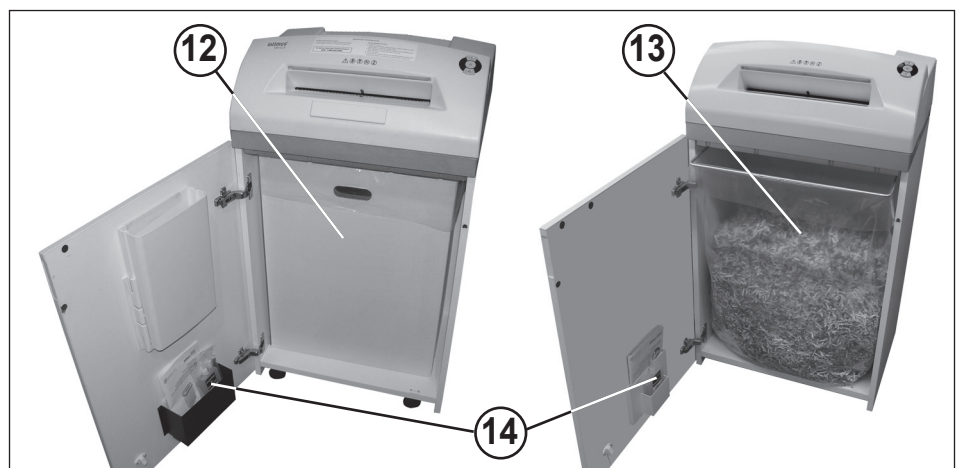

Fig. 4

MALFUNCTIONS

MATERIAL JAM IN THE MACHINE: (Auto reverse function)

If a jam is caused by too much material being fed in the following happens:

- The cutters jam, then run in reverse for a short time (material is released) and stop. The motor switches off. The control display (6) comes on.

Proceed as follows:

Paper jam in paper feed slot (11)

- Remove the paper that has been fed back.
- The cutters now run forwards automatically and shred the remaining paper in the cutters. During the forward run the forward button (3) LED display (7) comes on. The control display (6) goes out.
- Continue shredding with less paper.
- If necessary, switch the cutters manually alternately from forward to reverse until the material has gone through completely and been shredded.

LIGHT BARRIER COVERED WHEN DOOR OPENED:

Should there still be material in the feed slot when the door is opened, the motor switches off and the cutters stop. The control display (6) comes on.

Close the door and acknowledge the status by pressing the forward button (3) briefly. The existing material is fed to the cutters and shredded.

LIGHT BARRIER COVERED WHEN MACHINE TURNED ON:

Should there still be material in the feed slot when the machine is switched on the control display (6) comes on.

Remove the material and acknowledge the status by pressing the forward button (3) briefly.

MOTOR PROTECTION:

Should the motor be overloaded it switches off. The machine can be started again after a cooling down period of about 25 – 40 minutes.

ELECTRICAL FAULT:

If the control display (9) flashes together with the function button (2) LED display (7) or only the control display (8) flashes there is an electrical fault. The machine cannot be started. In this case please contact your dealer.

FAULT CHECK LIST:

Should the machine not work, check the following points:

- is the **plug** connected to the power supply?
- is the **door** closed?
- is the **paper collection bag** full?
Follow the instructions for "EMPTYING THE PAPER COLLECTION BAG".
- Is there a **material jam** in the machine?
Follow the instructions in "MATERIAL JAM IN THE MACHINE".
- Is the **motor** overloaded?
See "MOTOR PROTECTION".

If none of these test points apply, please contact your dealer.

MAINTENANCE / DISPOSING



Before starting any repair work and also before cleaning/maintenance which is not described in the following section always disconnect the mains power supply!



CLEANING THE PHOTOCELLS:

If paper particles should come to rest in the inlet guide (for example after a paper jam) it is possible that the machine will not turn off, due to the broken light barrier.

To remove these paper strips and also to clean the photocell, pass another sheet of paper through the feed slot, or switch the machine to reverse and wipe both "eyes" of the photocell with a brush.

CUTTER MAINTENANCE (CROSS CUT):



Cross cut cutters must be oiled after a specific operating time. If the control display (7) comes on proceed as follows:

Open the door. The control display (8) comes on and the reverse button (4) LED display (7) as well as the control display (7) flashes. Remove the oil reservoir (14) (Fig. 4) from the holder in the door and close the door again.

Pour a little oil onto a sheet of paper and then feed this through the paper feed slot (11) onto the cutters.

The paper is drawn in and in this way the oil is distributed to the cutters.

Note: This procedure is acknowledged as follows to turn off the display after the cutters have been oiled:

- Open the door until the control display (8) lights up. The control displays (7) and (4) flash.
- Press the reverse button (4) and keep it held down until the control display (7) goes out.
- Close the door again.

The cutters now start a cleaning cycle automatically (forward and reverse run) and then switch off. The machine is ready for use again. Should you need to re-order the special oil see "SPECIAL ACCESSORIES".

AUTOMATIC ENERGY SAVING:

If the machine is not used for a while it automatically switches off after about 5 minutes. The function button (2) LED display (7) for "Ready" goes out. Press the function button briefly to turn it on again.

DISPOSING OF THE MACHINE:



Dispose of the machine in an environmentally friendly fashion at the end of its useful service life. Do not dispose of any of the parts included in the machine or its packaging with household waste.

TECHNICAL DATA

Model	Typ	Cutting width paper	Cutting capacity paper	Working width	Noise level	Dimensions W x D x H	Weight
intimus 120SP2(SC2)	227-6S	0.23 in.	35-38 sheets*	12.20 in.	app. 57 dB(A)	21.06 x 15.55 x 38.58 in.	101.54 lb.
intimus 120SP2(SC2)	227-4S	0.15 in.	31-33 sheets*	12.20 in.	app. 57 dB(A)	21.06 x 15.55 x 38.58 in.	101.54 lb.
intimus 120CP4(CC3)	227-4C	0.15x1.42 in.	23-25 sheets*	12.20 in.	app. 57 dB(A)	21.06 x 15.55 x 38.58 in.	103.75 lb.
intimus 120CP5(CC4)	227-2C	0.07x0.59 in.	15-17 sheets*	12.20 in.	app. 57 dB(A)	21.06 x 15.55 x 38.58 in.	103.75 lb.
intimus 120CP6(CC5)	227-1C	0.03x0.47 in.	10-12 sheets*	12.20 in.	app. 57 dB(A)	21.06 x 15.55 x 38.58 in.	103.75 lb.
intimus 120CP7(CC6)	227-1CF	0.03x0.18 in.	7-8 sheets*	12.20 in.	app. 57 dB(A)	21.06 x 15.55 x 38.58 in.	103.75 lb.

Listed Circuit Breaker: 220-230V = 10 amps / 120V = 15 amps / 100V = 18 amps

* based on A4-paper 70g/m² at 230V/50Hz

Model	Power supply data		
	supply voltage/frequency · current consumption · power		
intimus 120SP2(SC2)	220-230V/50Hz · 7.8 amps · 1.8 kW	120V/60Hz · 12.0 amps · 1.4 kW	100V/50/60Hz · 18.0 amps · 1.8 kW
intimus 120SP2(SC2)	220-230V/50Hz · 7.8 amps · 1.8 kW	120V/60Hz · 12.0 amps · 1.4 kW	100V/50/60Hz · 18.0 amps · 1.8 kW
intimus 120CP4(CC3)	220-230V/50Hz · 7.8 amps · 1.8 kW	120V/60Hz · 12.0 amps · 1.4 kW	100V/50/60Hz · 18.0 amps · 1.8 kW
intimus 120CP5(CC4)	220-230V/50Hz · 7.8 amps · 1.8 kW	120V/60Hz · 12.0 amps · 1.4 kW	100V/50/60Hz · 18.0 amps · 1.8 kW
intimus 120CP6(CC5)	220-230V/50Hz · 7.8 amps · 1.8 kW	120V/60Hz · 12.0 amps · 1.4 kW	100V/50/60Hz · 18.0 amps · 1.8 kW
intimus 120CP7(CC6)	220-230V/50Hz · 7.8 amps · 1.8 kW	120V/60Hz · 12.0 amps · 1.4 kW	100V/50/60Hz · 18.0 amps · 1.8 kW

ACCESSORIES

Description

Plastic bag, 17.32x13.00x38.58x0.002 in. 99977
Lubricant, 110 ml bottle 88035

Order-No.

Note: For orders of special accessories and spare parts, please contact your dealer.

IMPORTANT SAFETY NOTES

<< The machine may not be operated by more than one person at any given time! The machine was designed for safe operation by "one person only".

<< During the shredding process no other work may be performed on the machine (for example cleaning, etc.)!

<< The machine is **not a toy**, and is **not suitable for use by children!** The overall technical safety concept of this machine (dimensions, feed openings, emergency shutdown devices etc.) does not provide for any guarantee regarding hazard-free operation by children.

<< **Danger of injury!** Keep all loose articles of clothing, ties, jewelry, long hair or other loose objects away from opening!

<< **Danger of injury!** Never insert fingers into opening!

<< In case of danger switch the machine off with the mains switch, or unplug the machine!

<< Always unplug the machine from the mains power supply before opening the machine! Repairs may only be performed by trained personnel!

Special materials

Model \ Symbol				
120SP2 (SC2)-3,8				X
120SP2 (SC2)-5,8				X
120CP4 (CC3)				X
120CP5 (CC4)				X
120CP6 (CC5)	X		X	X
120CP7 (CC6)	X	X	X	X

X = not applicable for shredding

Warning:
Moving parts can crush and cut!

Warning:
Electrical Hazard!

INITIATION

AREA OF APPLICATION:
The intimus 120 SP2(SC2)/CP4(CC3)/CP5(CC4)/CP6(CC5)/CP7(CC6) data shredder is a machine used for shredding general documents.

Generally the machine may only be used to shred paper (deviations see table below "special materials")! Shredding of other types of data carriers may lead to injuries (for example due to splintering of hard materials etc.) and damage to the machine (for example destruction of the cutter etc.).

INSTALLATION:

- Unpack the machine and put it together.
- Fit the plastic bag onto the bag frame.
- Attach the Power Cord to the Power Connection on the machine and plug into an AC outlet (1) (Fig. 2) (For information on the right fuse for the plug see "TECHNICAL DATA").

The socket outlet shall be installed near the equipment and shall be easily accessible!
Only operate the machine in enclosed rooms at temperatures between 10°C and 25°C!
Keep enough distance to the surroundings when installing the machine.

OPERATION

CONTROLS:

- Mains plug (Fig. 2)**
When the machine is first plugged in it is not on.
- Function buttons (Fig. 1)**
"Ready" / "Off" / "Stop"
This button has three functions:
 - "Ready"**
The machine changes to "Ready" if you press this button briefly. At the same time the integral LED display comes on.
 - "Off"**
The machine switches off if it is in the "Ready" mode and the button is held down for about 3 seconds.
Note: The machine switches off automatically if it is not used for about 5 minutes.
 - "Stop"**
If you press this button briefly when the cutters are running they switch off and stop.

- Forwards button (Fig. 1)**
This button has two functions:
 - If this button is pressed briefly, the cutting mechanism runs forwards for a few seconds, e.g. to remove remaining material from the cutting mechanism. At the same time the integrated LED display lights up.
 - If this button is pressed and held for approx. two secs., the cutting mechanism runs forwards continually and materials to be shredded can be fed into the machine. At the same time the integrated LED display lights up.
- Reverse button (Fig. 1)**
If you press this button the cutters run backwards for a short time. At the same time the integral LED display comes on.
- Light barrier (Forward motion) (Fig. 3)**
The shredding procedure starts as soon as material is fed into the feed slot. At the same time the integral forward button LED display comes on.

- Control display (Fig. 1)**
"Material jam in machine" / "Light barrier covered when door opens or when machine turned on"
For the procedures see the relevant description under the "MALFUNCTION" section.
 - "Material jam in machine"**
Comes on when too much material has been fed into the cutters. The cutters jam, then run in reverse for a short time and stop. The motor switches off.
 - "Light barrier covered when door open"**
Comes on when there is still material in the feed slot when the door is opened. The cutters stop. The motor switches off.
 - "Light barrier covered when machine turned on"**
Comes on when there is still material in the feed slot when the machine is switched on.

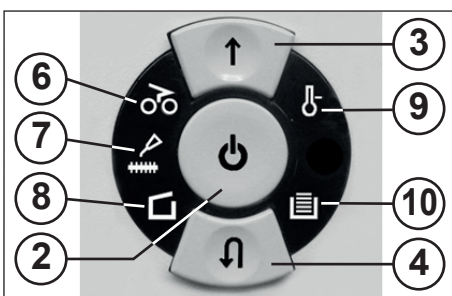

Fig. 1



Fig. 2

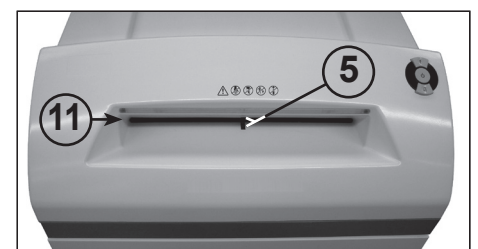

Fig. 3

OPERATION

CONTROLS:

7 = Control display (Fig. 1)
"Oil cutters"

Comes on when the cutters in the cross cut version must be oiled. The lubrication procedure must be acknowledged on the reverse button (4) (see description in "CUTTER MAINTENANCE").

8 = Control display (Fig. 1)
"Door open"/ "Door malfunction"

a) "Door open"

Comes on if the door on the lower part of the machine is opened. The machine switches off automatically and cannot be started as long as the door remains open.

b) "Electrical fault"

Flashes when there is an electrical fault in the door sensor. The machine switches off. Please contact your dealer.

9 = Control display (Fig. 1)

To find out what to do see the relevant description under the "MALFUNCTION" section.

"Electrical fault"

Flashes when there is an electrical fault inside the control board. At the same time the function button (2) LED display flashes. The machine switches off. Please contact your dealer.

10 = Control display (Fig. 1)

"Receptacle / Paper collection bag full"

Comes on when the receptacle / paper collection bag is full and must be emptied. The cutting unit for reducing paper switches off.

11 = Paper feed slot (Fig. 3)

12 = Receptacle (Fig. 4)

13 = Paper collection bag (Fig. 4)

14 = Oil reservoir (Fig. 4)



The shredder may not be used as a step ladder or as a seat. Danger of falling due to breakage!

SWITCHING THE MACHINE ON:

Proceed as follows to switch the machine to "Ready":

- Press the function button (2) briefly.
- The function button (2) LED display  comes on for "Ready".
- The machine can be loaded.

MATERIAL FEED:

Feed **paper** into the cutting mechanism through the paper feed slot (11) (Fig. 3).

The machine automatically switches to forwards running, draws the material in and automatically switches off after shredding.

Note: For shredding transparent films, the machine must be manually switched to forwards running (press and hold the forwards button (3) for approx. 2 secs.).

By briefly pressing the function button (2) (Stop function), the shredding process can be stopped at any time. To continue, press and hold the forwards button (3) for approx. 2 secs.

If the machine is not used for a period of approx. 5 mins., it automatically switches off.





Never feed the shredder with a quantity of material exceeding the maximum indicated. Refer to the TECHNICAL DATA section!



Should the machine become overloaded, follow the instructions under "MATERIAL JAM IN MACHINE" under "MALFUNCTIONS".

EMPTYING THE RECEPTACLE / PAPER COLLECTION BAG / (Fig. 4):



If the receptacle / paper collection bag is full the machine switches off. The control display  (10) comes on. Proceed as follows:

- Open the door. The control display  (8) comes on. If there is still material in one of the feed slots, the control display  (6) also comes on.

Receptacle (12):

- Pull out the receptacle from the lower part of the housing and empty the contents. The control display  (10) goes out.
- Slide the emptied receptacle (12) back into the lower part of the housing and close the door. The control display  (8) goes out.
- If the control display  (6) comes on, press the forward button (3) briefly. The remaining material in the feed slot is shredded and the display goes out.

Paper collection bag (13):

- Take the collection bag and the frame out of the bottom part of the housing. Remove the bag and dispose of the contents. The control display  (10) goes out.
- Fit the emptied bag onto the bag frame and insert the bag and the frame into the bottom part of the housing again. Close the door. The control display  (8) goes out.
- If the control display  (6) comes on, press the forward button (3) briefly. The remaining material in the feed slot is shredded and the display goes out.

Note: The machine will only run if the door is closed.

DYNAMIC LOAD DISPLAY:

To prevent a material jam and thus ensure a continual, effective destruction of the data carriers, the current load level of the motor is displayed during the shredding process by a coloured, diffuse light in the feed slot as follows:

- Green light: load < 50%
- Yellow light: load 50 - 75%
- Red light: load 75 - 100%

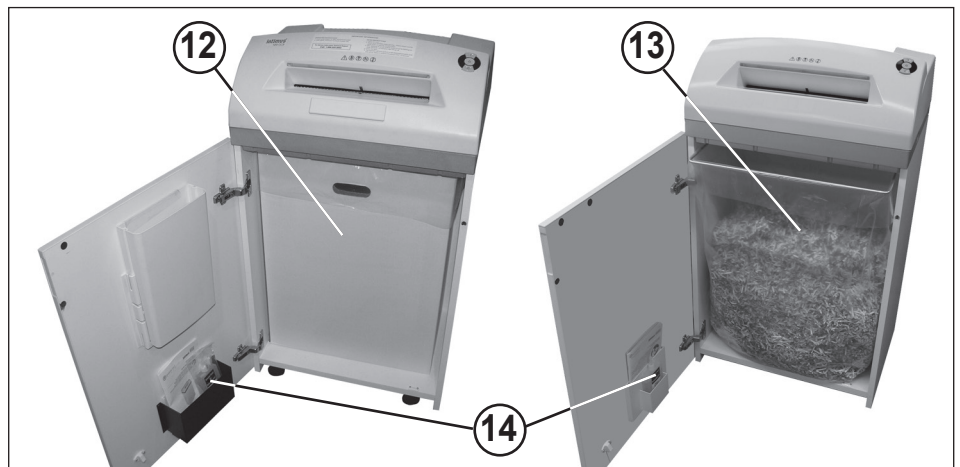

Fig. 4

MALFUNCTIONS

**MATERIAL JAM IN THE MACHINE:
(Auto reverse function)**

If a jam is caused by too much material being fed in the following happens:

- The cutters jam, then run in reverse for a short time (material is released) and stop. The motor switches off. The control display (6) comes on.

Proceed as follows:

Paper jam in paper feed slot (11)

- Remove the paper that has been fed back.
- The cutters now run forwards automatically and shred the remaining paper in the cutters. During the forward run the forward button (3) LED display (3) comes on. The control display (6) goes out.
- Continue shredding with less paper.
- If necessary, switch the cutters manually alternately from forward to reverse until the material has gone through completely and been shredded.

**LIGHT BARRIER COVERED
WHEN DOOR OPENED:**

Should there still be material in the feed slot when the door is opened, the motor switches off and the cutters stop. The control display (6) comes on.

Close the door and acknowledge the status by pressing the forward button (3) briefly. The existing material is fed to the cutters and shredded.

**LIGHT BARRIER COVERED
WHEN MACHINE TURNED ON:**

Should there still be material in the feed slot when the machine is switched on the control display (6) comes on.

Remove the material and acknowledge the status by pressing the forward button (3) briefly.

MOTOR PROTECTION:

Should the motor be overloaded it switches off. The control display (9) comes on. The machine can be started again after a cooling down period of about 25 – 40 minutes.

ELECTRICAL FAULT:

If the control display (9) flashes together with the function button (2) LED display (2) or only the control display (8) flashes there is an electrical fault. The machine cannot be started. In this case please contact your dealer.

FAULT CHECK LIST:

Should the machine not work, check the following points:

- is the **plug** connected to the power supply?
- is the **door** closed?
- is the **paper collection bag** full?
Follow the instructions for "EMPTYING THE PAPER COLLECTION BAG".
- Is there a **material jam** in the machine?
Follow the instructions in "MATERIAL JAM IN THE MACHINE".
- Is the **motor** overloaded?
See "MOTOR PROTECTION".

If none of these test points apply, please contact your dealer.

MAINTENANCE / DISPOSING

Before starting any repair work and also before cleaning/maintenance which is not described in the following section always disconnect the mains power supply!

CLEANING THE PHOTOCELLS:

If paper particles should come to rest in the inlet guide (for example after a paper jam) it is possible that the machine will not turn off, due to the broken light barrier.

To remove these paper strips and also to clean the photocell, pass another sheet of paper through the feed slot, or switch the machine to reverse and wipe both "eyes" of the photocell with a brush.

CUTTER MAINTENANCE (CROSS CUT):

Cross cut cutters must be oiled after a specific operating time. If the control display (7) comes on proceed as follows: Open the door. The control display (8) comes on and the reverse button (4) LED display (4) as well as the control display (7) flashes. Remove the oil reservoir (14) (Fig. 4) from the holder in the door and close the door again.

Pour a little oil onto a sheet of paper and then feed this through the paper feed slot (11) onto the cutters.

The paper is drawn in and in this way the oil is distributed to the cutters.

Note: This procedure is acknowledged as follows to turn off the display after the cutters have been oiled:

- Open the door until the control display (8) lights up. The control displays (7) and (4) flash.
- Press the reverse button (4) and keep it held down until the control display (7) goes out.
- Close the door again.

The cutters now start a cleaning cycle automatically (forward and reverse run) and then switch off. The machine is ready for use again. Should you need to re-order the special oil see "SPECIAL ACCESSORIES".

AUTOMATIC ENERGY SAVING:

If the machine is not used for a while it automatically switches off after about 5 minutes. The function button (2) LED display (2) for "Ready" goes out. Press the function button briefly to turn it on again.

DISPOSING OF THE MACHINE:

Dispose of the machine in an environmentally friendly fashion at the end of its useful service life. Do not dispose of any of the parts included in the machine or its packaging with household waste.

TECHNICAL DATA

Model	Typ	Cutting width paper	Cutting capacity paper	Working width	Noise level	Dimensions W x D x H	Weight
intimus 120SP2(SC2)	227-6S	5.8 mm	35-38 sheets*	310 mm	app. 57 dB(A)	535 x 395 x 980 mm	46 kg
intimus 120SP2(SC2)	227-4S	3.8 mm	31-33 sheets*	310 mm	app. 57 dB(A)	535 x 395 x 980 mm	46 kg
intimus 120CP4(CC3)	227-4C	3.8x36 mm	23-25 sheets*	310 mm	app. 57 dB(A)	535 x 395 x 980 mm	47 kg
intimus 120CP5(CC4)	227-2C	1.9x15 mm	15-17 sheets*	310 mm	app. 57 dB(A)	535 x 395 x 980 mm	47 kg
intimus 120CP6(CC5)	227-1C	0.8x12 mm	10-12 sheets*	310 mm	app. 57 dB(A)	535 x 395 x 980 mm	47 kg
intimus 120CP7(CC6)	227-1CF	0.8x4.5 mm	7-8 sheets*	310 mm	app. 57 dB(A)	535 x 395 x 980 mm	47 kg

Pre-fusing (slow-blow): 220-230V = 10 amps / 120V = 15 amps / 100V = 18 amps

* based on A4-paper 70g/m² at 230V/50Hz

Model	Power supply data		
	supply voltage/frequency · current consumption · power		
intimus 120SP2(SC2)	220-230V/50Hz · 7.8 amps · 1.8 kW	120V/60Hz · 12.0 amps · 1.4 kW	100V/50/60Hz · 18.0 amps · 1.8 kW
intimus 120SP2(SC2)	220-230V/50Hz · 7.8 amps · 1.8 kW	120V/60Hz · 12.0 amps · 1.4 kW	100V/50/60Hz · 18.0 amps · 1.8 kW
intimus 120CP4(CC3)	220-230V/50Hz · 7.8 amps · 1.8 kW	120V/60Hz · 12.0 amps · 1.4 kW	100V/50/60Hz · 18.0 amps · 1.8 kW
intimus 120CP5(CC4)	220-230V/50Hz · 7.8 amps · 1.8 kW	120V/60Hz · 12.0 amps · 1.4 kW	100V/50/60Hz · 18.0 amps · 1.8 kW
intimus 120CP6(CC5)	220-230V/50Hz · 7.8 amps · 1.8 kW	120V/60Hz · 12.0 amps · 1.4 kW	100V/50/60Hz · 18.0 amps · 1.8 kW
intimus 120CP7(CC6)	220-230V/50Hz · 7.8 amps · 1.8 kW	120V/60Hz · 12.0 amps · 1.4 kW	100V/50/60Hz · 18.0 amps · 1.8 kW

ACCESSORIES

Description	Order-No.
Plastic bag, 440x330x950x0.05 mm	99977
Lubricant, 110 ml bottle	88035

Note: For orders of special accessories and spare parts, please contact your dealer.

RECOMMANDATIONS IMPORTANTES DE SÉCURITÉ



<< La machine ne doit pas être utilisée par plusieurs personnes en même temps!
La conception des éléments de sécurité repose sur une mise en service sans danger pour "L'utilisation de la machine par une seule personne".



<< Ne pas effectuer d'autres activités sur la machine (par ex. nettoyage...) durant le procédé de destruction!



<< La machine n'est pas un jouet et ne convient pas pour être utilisée par des enfants!
Le concept global de sécurité (dimensions, orifices d'alimentation, mises hors circuit de sécurité, etc.) de cette machine ne fournit aucune garantie pour une manipulation sans danger par les enfants.



<< **Risque de blessure!** N'approchez jamais du bloc de coupe les vêtements amples, colliers, cheveux longs, cravates etc!



<< **Risque de blessure!** N'introduisez jamais les doigts dans l'ouverture!



<< En cas de danger, arrêter la machine par l'interrupteur principal, ou débranchez la machine!



<< Débrancher le raccordement réseau avant d'ouvrir l'installation!
Les travaux de réparation doivent être effectués uniquement par un spécialiste!

Matériaux spéciaux

Model	Symbol				
120SP2 (SC2)-3,8					X
120SP2 (SC2)-5,8					X
120CP4 (CC3)					X
120CP5 (CC4)					X
120CP6 (CC5)	X		X		X
120CP7 (CC6)	X	X	X		X

X = ne convient pas pour le broyage

MISE EN MARCHÉ

DOMAINES D'UTILISATION:

Le destructeur de documents intimes 120 SP2(SC2)/CP4(CC3)/CP5(CC4)/CP6(CC5)/CP7(CC6) est un appareil destiné à détruire des documents courants.



En principe, l'appareil peut uniquement être utilisé pour broyer du papier (exceptions, voir tableau sous « matériaux spéciaux »)!
Le broyage d'autres supports de données peut se traduire par des blessures de personnes (éclatement de matériaux solides par ex., etc.) et de dégâts à l'appareil (destruction du mécanisme de coupe par ex.).

INSTALLATION :

- Déballez l'appareil et l'installer.
- Accrocher le sac de plastique dans le cadre pour sac.
- Relier le cordon d'alimentation à la fiche d'alimentation électrique de la machine et branchez sur la prise secteur (1) (fig. 2) (voir les indications concernant le fusible auxiliaire requis pour la prise secteur dans les « CARACTERISTIQUES TECHNIQUES »).



Le raccordement au secteur de la machine doit être librement accessible et doit se trouver à proximité de la machine!

Utiliser la machine uniquement dans des locaux fermés et tempérés (10 – 25 °C)! Placer toujours la machine à une distance suffisante du mur!



Attention:
Danger de contusion et de coupure à cause des pièces mobiles!



Attention:
Risque de blessure à cause de la tension électrique!

UTILISATION

ELEMENTS DE COMMANDE:

- 1 = Fiche secteur (fig. 2)
Lorsqu'elle est raccordée au secteur électrique par le biais de la fiche secteur, la machine est tout d'abord éteinte.
- 2 = Touche de fonction (fig. 1)
« Prêt à fonctionner » / « Arrêt » / « Stop »
Cette touche comprend trois fonctions:
- a) « Prêt à fonctionner »
Frapper brièvement sur cette touche pour commuter la machine sur « prêt à fonctionner ». Simultanément, le voyant LED intégré s'allume.
- b) « Arrêt »
Maintenir enfoncée cette touche dans l'état « prêt à fonctionner » pendant env. 3 secondes pour éteindre la machine.
Remarque: La machine s'éteint automatiquement en cas de non utilisation pendant un laps de temps d'environ 5 minutes.

- c) « Stop »
Frapper brièvement sur cette touche pendant que le bloc de coupe fonctionne pour éteindre et arrêter celui-ci.
- 3 = Touche de marche avant (fig. 1)
Cette touche comprend deux fonctions :
- a) Une frappe brève sur cette touche a pour effet de faire avancer le bloc de coupe pendant quelques secondes, par ex. pour faire sortir un document resté dans le bloc de coupe. Simultanément, le voyant LED intégré s'allume.
- b) Si cette touche est maintenue enfoncée pendant env. deux secondes, le bloc de coupe fonctionne en permanence en avant et la machine peut être alimentée. Simultanément, le voyant LED intégré s'allume.
- 4 = Touche de marche arrière (fig. 1)
Un actionnement de cette touche fait reculer brièvement le bloc de coupe. Simultanément, le voyant LED intégré s'allume.
- 5 = Barrière lumineuse (marche avant) (fig. 3)
Démarre l'opération de broyage dès que du matériau est introduit dans la fente d'alimentation. Simultanément, le voyant LED intégré de la touche marche avant s'allume.

- 6 = Voyant de contrôle (fig. 1)
« Bourrage de matériau dans l'appareil » / « Barrière lumineuse occupée lors de l'ouverture de porte ou lors de la mise en marche »
Lire la description des manières de procéder sous la rubrique « PANNE ».
- a) « Bourrage de matériau dans l'appareil »
S'allume lorsque la quantité de matériau chargée dans le bloc de coupe est trop importante. Le bloc de coupe se bloque, se déplace ensuite un peu vers l'arrière et s'arrête. Le moteur s'éteint.
- b) « Barrière lumineuse occupée lors de l'ouverture de porte »
S'allume lorsque du matériau se trouve encore dans la fente d'alimentation lors de l'ouverture de la porte. Le bloc de coupe s'arrête. Le moteur s'éteint.
- c) « Barrière lumineuse occupée lors de la mise en marche »
S'allume lorsque du matériau se trouve dans la fente d'alimentation lors de la mise en marche de la machine.

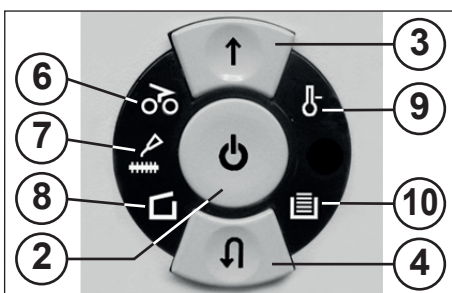

fig. 1

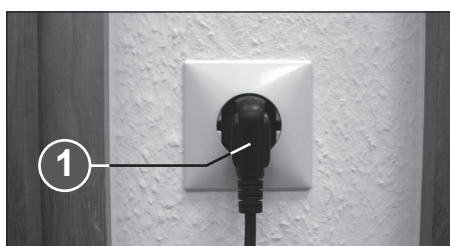

fig. 2

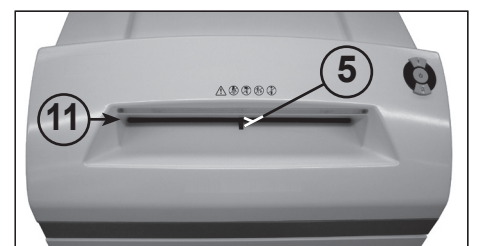

fig. 3

UTILISATION

ELEMENTS DE COMMANDE :

7 = Voyant de contrôle (fig. 1)

« Lubrifier bloc de coupe »

S'allume lorsque le bloc de coupe de la version Cross-Cut doit être lubrifié. L'opération de lubrification doit être validée sur la touche de marche arrière (voir description « MAINTENANCE BLOC DE COUPE »)

8 = Voyant de contrôle (fig. 1)

« Porte ouverte »/ « Perturbation porte »

a) « Porte ouverte »

S'allume lorsque la porte de l'armoire inférieure est ouverte. La machine s'éteint automatiquement et ne peut être démarrée tant que la porte reste ouverte.

b) « Dysfonctionnement électrique »

Clignote, lorsque le capteur de porte présente un dysfonctionnement électrique. La machine s'éteint. Veuillez en informer votre distributeur spécialisé.

9 = Voyant de contrôle (fig. 1)

Lire la description des manières de procéder sous la rubrique « PANNE ».

« Dysfonctionnement électrique »

Clignote en présence d'un dysfonctionnement électrique sur le circuit imprimé de commande. Simultanément, le voyant LED  de la touche de fonction (2) s'allume. La machine s'éteint. Veuillez en informer votre distributeur spécialisé.

10 = Voyant de contrôle (fig. 1)

« Bac collecteur / Sac collecteur de papier plein »

S'allume lorsque le bac collecteur / sac collecteur pour papier est rempli et qu'il doit être vidé. Le bloc de coupe pour le broyage de papier s'éteint.

11 = Fente d'alimentation de papier (fig. 3)

12 = Bac collecteur (fig. 4)

13 = Sac collecteur pour papier (fig. 4)

14 = Récipient d'huile (fig. 4)



N'utiliser en aucun cas le destructeur en tant que siège ou surface de marche. Risque de chute suite à la rupture de matériel !

MISE EN MARCHÉ DE LA MACHINE :

Pour mettre la machine sur « prêt à fonctionner », procéder comme suit :

- Actionner brièvement la touche de fonction (2)
- Le voyant LED  de la touche de fonction (2) s'allume et affiche « prêt à fonctionner ».
- La machine peut être alimentée.

ALIMENTATION DE MATERIAU :

Alimenter le bloc de coupe en **papier** par la fente d'alimentation de papier (11) (fig. 3).

La machine passe automatiquement en marche avant, aspire le matériau et s'éteint de nouveau automatiquement lorsque le broyage est terminé.

Remarques: Pour le broyage de films transparents, il convient de commuter la machine manuellement sur la marche avant (maintenir la touche marche avant (3) enfoncée pendant environ 2 secondes).

Il est possible de stopper à tout moment le broyage en actionnant brièvement la touche de fonction (2) (fonction « stop »). Pour poursuivre, maintenir la touche de marche avant (3) enfoncée pendant environ 2 secondes.

La machine s'éteint automatiquement en cas de non utilisation pendant un laps de temps d'environ 5 minutes.





Ne jamais alimenter l'appareil avec une quantité de matériau supérieure au maximum indiqué (voir « CARACTERISTIQUES TECHNIQUES »).



Si malgré tout, une quantité trop importante de matériau parvient dans le bloc de coupe, voir la rubrique « PANNE » sous « BOURRAGE DE MATERIAU DANS L'APPAREIL ».

VIDER LE BAC COLLECTEUR / SAC COLLECTEUR POUR PAPIER (fig. 4) :



La machine s'éteint lorsque le bac collecteur / sac collecteur pour papier est rempli. Le voyant de contrôle  (10) s'allume. Procéder comme suit :

- Ouvrir la porte. Le voyant de contrôle  (8) s'allume. Si du matériau se trouve encore dans la fente d'alimentation, le voyant de contrôle  (6) s'allume également.

BAC COLLECTEUR (12) :

- Tirer le bac collecteur hors de la partie inférieure du carter et vider le contenu. L'affichage de contrôle  (10) s'éteint.
- Glisser de nouveau le bac collecteur vide (12) dans la partie inférieure du carter et fermer la porte. L'affichage de contrôle  (8) s'éteint.
- Si le voyant de contrôle  (6) s'allume, actionner brièvement la touche de marche avant (3). Le matériau resté dans la fente d'alimentation est broyé et le voyant s'éteint.

SAC COLLECTEUR POUR PAPIER (13) :

- Extraire le sac collecteur avec le cadre pour sac hors de la partie inférieure du boîtier, retirer le sac et en éliminer son contenu. Le voyant de contrôle  (10) s'éteint.
- Accrocher le sac vidé dans le cadre pour sac et replacer le sac et le cadre dans la partie inférieure du boîtier. Fermer la porte. Le voyant de contrôle  (8) s'éteint.
- Si le voyant de contrôle  (6) s'allume, actionner brièvement la touche de marche avant (3). Le matériau resté dans la fente d'alimentation est broyé et le voyant s'éteint.

Remarque: La machine fonctionne uniquement lorsque la porte est fermée !

AFFICHAGE

DYNAMIQUE DE SOLLICITATION :

Afin d'éviter un bourrage de matériau et donc pour obtenir la destruction continue et efficace des supports de données, le degré momentané de sollicitation du moteur est affiché comme suit en cours de broyage par une lumière colorée et diffuse dans la fente d'alimentation :

Lumière verte :	Sollicitation < 50%
Lumière jaune :	Sollicitation 50 - 75%
Lumière rouge :	Sollicitation 75 - 100%

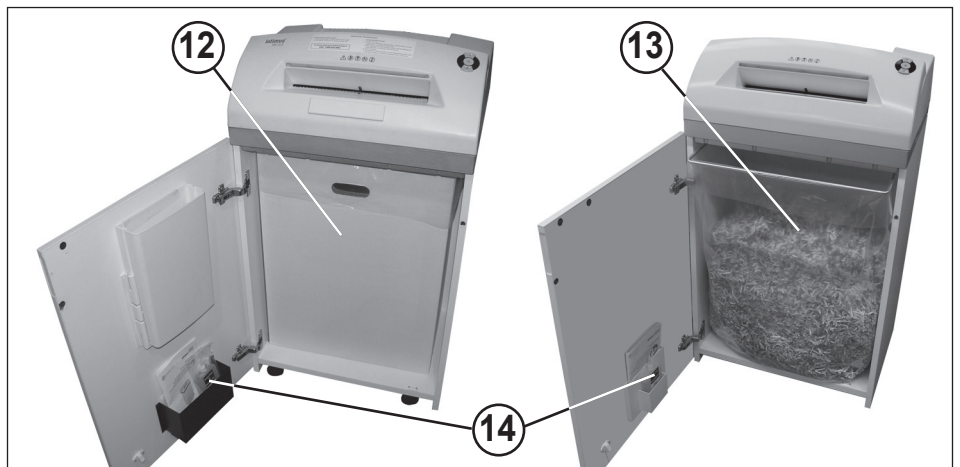

fig. 4

COMMENT REMEDIER AUX PETITES PANNES

**BOURRAGE DE MATERIAU DANS L'APPAREIL:
[Fonction Auto-Reverse]**

Si une quantité trop importante de matériau provoque un bourrage, la machine réagit comme suit:

- Le bloc de coupe se bloque, se déplace ensuite un peu vers l'arrière (ce qui libère le matériau) et s'arrête. Le moteur s'éteint. Le voyant de contrôle (6) s'allume.

Procéder comme suit:

Bourrage de papier dans la fente d'alimentation pour papier (11)

- Enlever le papier introduit.
- Le coupe de bloc avance maintenant automatiquement et broie les résidus de papier restés dans le bloc de coupe. En cours de marche avant, le voyant LED ↑ de la touche marche avant (3) s'allume. Le voyant de contrôle (6) s'éteint.
- Poursuivre le broyage avec une quantité de papier plus faible.
- Si nécessaire, commuter manuellement le bloc de coupe en alternance en marche avant et en marche arrière, jusqu'à ce que le matériau soit entièrement passé et broyé.

**BARRIERE LUMINEUSE OCCUPEE
LORS DE L'OUVERTURE DE PORTE:**

Si du matériau se trouve encore dans la fente d'alimentation lors de l'ouverture de la porte, le moteur s'éteint et le bloc de coupe s'arrête. Le voyant de contrôle (6) s'allume.

Fermer la porte et valider l'état en actionnant brièvement la touche de marche avant (3). Le matériau présent passe dans le bloc de coupe et est broyé.

**BARRIERE LUMINEUSE OCCUPEE
LORS DE LA MISE EN MARCHÉ:**

Si du matériau se trouve dans la fente d'alimentation lors de la mise en marche de la machine, le voyant de contrôle (6) s'allume. Retirer le matériau et valider l'état en actionnant brièvement la touche de marche avant (3).

PROTECTION DU MOTEUR:

Le moteur s'éteint s'il est surchargé. Après une période de refroidissement d'environ 25 à 40 minutes, il est possible de redémarrer l'appareil.

DYSFONCTIONNEMENT ELECTRIQUE:

Il y a dysfonctionnement électrique si le voyant de contrôle (9) **clignote** parallèlement avec le voyant LED de la touche de fonction (2) ou si seul le voyant de contrôle (8) **clignote**. Il n'est pas possible de démarrer la machine. Dans ce cas, veuillez informer votre distributeur spécialisé.

LISTE DE CONTROLE EN CAS DE PANNES:

Si l'appareil ne fonctionne pas, vérifier les points ci-après:

- La **fiche secteur** est-elle raccordée au secteur ?
- La **porte** est-elle fermée ?
- Le **sac collecteur pour papier** est-il plein ? Suivre les instructions « VIDER LE SAC COLLECTEUR POUR PAPIER ».
- Y a-t-il un **bourrage de matériau** dans l'appareil ? Suivre les instructions « BOURRAGE DE MATERIAU DANS L'APPAREIL ».
- Le **moteur** a-t-il été surchargé ? Voir sous « PROTECTION DU MOTEUR ».

Si aucun des points de contrôle n'est pertinent, veuillez en informer votre distributeur spécialisé.

ENTRETIEN / ELIMINATION



Veuillez enlever la prise de courant avant tous travaux de réparation, de nettoyage et d'entretien qui ne sont pas mentionnés spécialement dans le texte suivant !

**NETTOYAGE DES CELLULES PHOTOELECTRIQUES:**

Il est possible que des morceaux de papier restent dans la rainure d'admission (par ex. après un bourrage de papier) et empêchent la barrière lumineuse « occupée » d'arrêter l'appareil.

Il est possible d'enlever ces morceaux de papier ou de nettoyer les cellules photoélectriques, soit en introduisant une nouvelle feuille de papier dans le bloc de coupe, soit en déclenchant la marche arrière et en passant brièvement un pinceau sur les « yeux » des cellules photoélectriques.

MAINTENANCE DU BLOC DE COUPE (CROSS-CUT):

Les blocs de coupe Cross-Cut doivent être lubrifiés après avoir fonctionné un certain temps. Si le voyant de contrôle (7) s'allume, procéder comme suit:

Ouvrir la porte. Le voyant de contrôle (8) s'allume et le voyant LED de la touche de marche arrière (4) ainsi que le voyant de contrôle (7) **clignotent**. Retirer le récipient d'huile (14) (fig. 4) de son support dans la porte et refermer la porte.

Répondre un peu d'huile sur une feuille de papier et faire passer la feuille dans le bloc de coupe au travers de la fente d'alimentation de papier (11).

Le papier est aspiré et l'huile parvient ainsi dans le bloc de coupe.

Remarque: Afin de faire disparaître les voyants de contrôle, il convient de valider la fin de l'opération de lubrification du bloc de coupe comme suit:

- Ouvrir la porte jusqu'à ce que le voyant de contrôle (8) s'allume. Les voyants de contrôle (7) et (4) **clignotent**.

- Actionner la touche de marche arrière (4) et la maintenir enfoncée jusqu'à ce que le voyant de contrôle (7) s'éteigne.
- Refermer la porte.

Le bloc de coupe commence maintenant automatiquement un cycle de nettoyage (course marche avant/course marche arrière) et ensuite il s'éteint. La machine est à nouveau prête à fonctionner. Pour recommander ultérieurement de l'huile spéciale, voir « ACCESSOIRES SPECIAUX ».

MODE AUTOMATIQUE ECONOMIE D'ENERGIE:

Lorsque la machine n'est pas utilisée pendant un certain temps, elle s'éteint automatiquement après environ 5 minutes. Le voyant LED de la touche de fonction (2) indiquant « prêt à fonctionner » s'éteint. Actionner brièvement la touche de fonction pour remettre la machine en marche.

ELIMINATION DE LA MACHINE:

Lorsqu'elle est en fin de durée de vie, toujours éliminer la machine de façon conforme à l'environnement. Ne jamais jeter aucune pièce de la machine ou de l'emballage avec les ordures ménagères.

CARACTÉRISTIQUES TECHNIQUES

Modèle	Type	Largeur de coupe papier	Capacité de coupe papier	Largeur de travail	Niveau de bruit	Dimensions L x P x H	Poids
intimus 120SP2(SC2)	227-6S	5,8 mm	35-38 feuilles*	310 mm	ca. 57 dB(A)	535 x 395 x 980 mm	46 kg
intimus 120SP2(SC2)	227-4S	3,8 mm	31-33 feuilles*	310 mm	ca. 57 dB(A)	535 x 395 x 980 mm	46 kg
intimus 120CP4(CC3)	227-4C	3,8x36 mm	23-25 feuilles*	310 mm	ca. 57 dB(A)	535 x 395 x 980 mm	47 kg
intimus 120CP5(CC4)	227-2C	1,9x15 mm	15-17 feuilles*	310 mm	ca. 57 dB(A)	535 x 395 x 980 mm	47 kg
intimus 120CP6(CC5)	227-1C	0,8x12 mm	10-12 feuilles*	310 mm	ca. 57 dB(A)	535 x 395 x 980 mm	47 kg
intimus 120CP7(CC6)	227-1CF	0,8x4,5 mm	7-8 feuilles*	310 mm	ca. 57 dB(A)	535 x 395 x 980 mm	47 kg

Fusible (à action retardée): 220-230V = 10 A / 120V = 15 A / 100V = 18 A

* se réfère à du papier A4 70g/m2 pour 230 V/50 Hz

Modèle	Caractéristiques branchement sur le secteur		
	tension de raccordement/fréquence · courant absorbé · puissance		
intimus 120SP2(SC2)	220-230V/50Hz · 7,8 A · 1,8 kW	120V/60Hz · 12,0 A · 1,4 kW	100V/50/60Hz · 18,0 A · 1,8 kW
intimus 120SP2(SC2)	220-230V/50Hz · 7,8 A · 1,8 kW	120V/60Hz · 12,0 A · 1,4 kW	100V/50/60Hz · 18,0 A · 1,8 kW
intimus 120CP4(CC3)	220-230V/50Hz · 7,8 A · 1,8 kW	120V/60Hz · 12,0 A · 1,4 kW	100V/50/60Hz · 18,0 A · 1,8 kW
intimus 120CP5(CC4)	220-230V/50Hz · 7,8 A · 1,8 kW	120V/60Hz · 12,0 A · 1,4 kW	100V/50/60Hz · 18,0 A · 1,8 kW
intimus 120CP6(CC5)	220-230V/50Hz · 7,8 A · 1,8 kW	120V/60Hz · 12,0 A · 1,4 kW	100V/50/60Hz · 18,0 A · 1,8 kW
intimus 120CP7(CC6)	220-230V/50Hz · 7,8 A · 1,8 kW	120V/60Hz · 12,0 A · 1,4 kW	100V/50/60Hz · 18,0 A · 1,8 kW

ACCESSOIRES

Désignation

Sac en plastique, 440x330x950x0,05 mm

Flacon d'huile special, 110 ml





Notez: Pour les accessoires et pièces détachées, veuillez contacter votre agent.



Ordre-No.

99977





88035

INDICACIONES DE SEGURIDAD IMPORTANTES

-  << ¡El aparato no debe ser operado por varias personas al mismo tiempo!
La concepción de los elementos de seguridad se basa en un manejo sin peligro en un „servicio por una sola persona“.
-  << ¡Durante el proceso de trituración no se deben efectuar otros trabajos en la máquina (p. ej. limpieza etc.)!
-  << ¡La máquina no es un juguete y no es apropiada para el empleo y uso por parte de niños!
El concepto global en razón de la seguridad (dimensiones, orificios de alimentación, desconexiones de seguridad, etc.) de esta máquina no incluye ningún tipo de garantía en cuanto a un manejo inofensivo por parte de niños.
-  << ¡Peligro de lesión! No acercarse a la apertura de alimentación piezas sueltas de ropa, corbatas, bisutería, cabello largo u otros objetos sueltos!

-  << ¡Peligro de lesión! No introducir los dedos en la apertura de alimentación!
-  << ¡En caso de emergencia desconectar el aparato usando el interruptor principal o extraer la clavija de red!
-  << Antes de abrir el aparato hay que extraer la clavija de red!
¡Las reparaciones solamente debe efectuarlas un técnico especialista!

Materiales especiales

Model	Symbol				
120SP2 (SC2)-3,8					X
120SP2 (SC2)-5,8					X
120CP4 (CC3)					X
120CP5 (CC4)					X
120CP6 (CC5)	X		X		X
120CP7 (CC6)	X	X	X	X	X

X = no apropiado para el desmenuzamiento

 **Atención:**
Peligro de magulladura o heridas de corte por partes en movimiento!

 **Atención:**
Peligro de lesiones por tensión eléctrica!

PUESTA EN SERVICIO

CAMPO DE APLICACIÓN:
El shredder de datos intimus 120 SP2(SC2)/CP4(CC3)/CP5(CC4)/CP6(CC5)/CP7(CC6) es un aparato para la trituración de información escrita.

 ¡La máquina solamente debe ser utilizada para el desmenuzamiento de papel (puede consultar las excepciones en la tabla en „Materiales especiales“)! El desmenuzamiento de soportes de datos de otro tipo puede tener como consecuencia lesiones en personas (p. ej. debido a fragmentos de materiales compactos, etc.), así como daños en la máquina (p. ej. destrucción del mecanismo de corte, etc.).

COLOCACIÓN:





- Desembale y coloque el aparato.
- Cuelgue el saco de plástico en el marco del saco.
- Conecte, utilizando el cable suministrado, el terminal de corriente del aparato a una toma de corriente alterna (1) (Fig. 2) (ver las indicaciones sobre el fusible previo necesario del tomacorriente en “CARACTERÍSTICAS TÉCNICAS”).

 ¡La toma de conexión a la red de la máquina tiene que encontrarse en un lugar fácilmente accesible y en las inmediaciones de la máquina!
¡La máquina sólo se deberá usar en recintos cerrados y con temperaturas comprendidas entre 10 – 25°C.
Instale la máquina con una separación suficiente de la pared.

MANEJO

ELEMENTOS DE MANDO:

- 1 = Clavija de enchufe a la red (Fig. 2)
Al enchufar la máquina a través de la clavija de enchufe a la red eléctrica, la máquina se encuentra en primer lugar desconectada.
- 2 = Pulsador funcional (Fig. 1)
“Listo para el uso” / “Apagado” / “Parada”
Este pulsador comprende tres funciones:
 - a) “Listo para el uso”
Accionando brevemente este pulsador se conecta el equipo en el modo de funcionamiento “listo para el uso”.
Al mismo tiempo se encenderá el indicador piloto integrado .
 - b) “Apagado”
Si se acciona este pulsador en el modo de funcionamiento “Listo para el uso” aprox. por 3 seg., la máquina se desconectará.
Nota: Si la máquina no se utiliza durante un periodo de tiempo de aprox. 5 min., se apagará automáticamente.

- c) “Parada”
Al accionar brevemente este pulsador mientras el mecanismo de corte está en marcha, se desconectará éste y se quedará parado.
- 3 = Pulsador de avance (Fig. 1)
Este pulsador comprende dos funciones:
 - a) Accionando brevemente este pulsador, el mecanismo de corte avanzará unos pocos segundos, por ejemplo, para sacar el material que aún se encuentra en el mecanismo de corte. Al mismo tiempo se encenderá el indicador piloto integrado .
 - b) Si este pulsador se mantiene oprimido durante unos dos segundos, el mecanismo de corte avanzará de modo continuo, por lo que el máquina se podrá suministrar con material. Al mismo tiempo se encenderá el indicador piloto integrado .
- 4 = Pulsador de retroceso (Fig. 1)
El mecanismo de corte retrocede brevemente al accionar este pulsador. Al mismo tiempo se encenderá el indicador piloto integrado .
- 5 = Barrera fotoeléctrica (avance) (Fig. 3)
Inicia el proceso de desmenuzamiento en el momento de introducir material en la ranura de alimentación. Al mismo tiempo se encenderá el indicador piloto  del pulsador de avance.

- 6 = Indicador de control (Fig. 1)
“Material atascado en el aparato” / “Barrera fotoeléctrica tapada por apertura de puerta o por conexión”
Para el modo de proceder consulte la descripción correspondiente en el apartado “AVERÍA”.
 - a) “Material atascado en el aparato”
Se encenderá al introducir demasiado material en el mecanismo de corte. El mecanismo de corte se bloquea, retrocede a continuación un poco y se para. El motor se desconecta.
 - b) “Barrera fotoeléctrica tapada por apertura de puerta”
Se enciende si al abrir la puerta sigue habiendo material en la ranura de alimentación. El mecanismo de corte se para. El motor se desconecta.
 - c) “Barrera fotoeléctrica tapada por conexión”
Se enciende si al conectar la máquina sigue habiendo material en la ranura de alimentación.

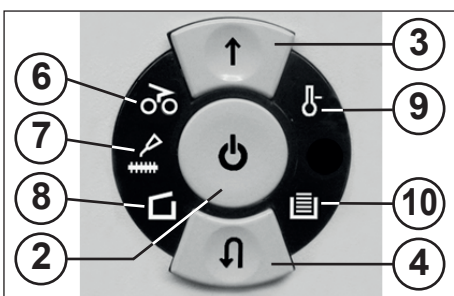

Fig. 1



Fig. 2

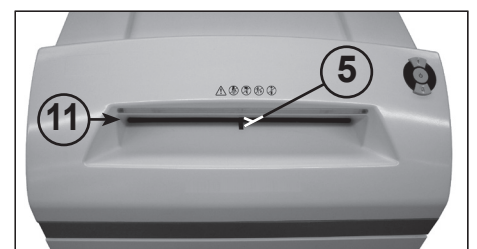

Fig. 3

MANEJO

ELEMENTOS DE MANDO:

7 = Indicador de control (Fig. 1)

"Engrasar mecanismo de corte"

Se enciende cuando el mecanismo de corte de la versión Cross-Cut (cruzado) se tiene que engrasar. El proceso de engrase se tiene que confirmar con el pulsador de retroceso (4) (ver descripción en "MANTENIMIENTO DEL MECANISMO DE CORTE").

8 = Indicador de control (Fig. 1)

"Puerta abierta" / "Avería eléctrica"

a) "Puerta abierta"

Se enciende si la puerta del armario inferior está abierta. El aparato se desconecta automáticamente y no se puede conectar mientras la puerta siga estando abierta.

b) "Avería eléctrica"

parpadea, si ha surgido una avería eléctrica en los sensores de la puerta. El aparato se desconecta. Avise al comercio especializado más cercano.

9 = Indicador de control (Fig. 1)

Para el modo de proceder consulte la descripción correspondiente en el apartado "AVERÍA".

"Avería eléctrica"

parpadea, si ha surgido una avería eléctrica dentro de la placa de circuitos impresos del sistema de mando. Al mismo tiempo se encenderá el indicador piloto \odot del pulsador funcional (2). La máquina se desconecta. Avise al comercio especializado más cercano.

10 = Indicador de control (Fig. 1)

"Recipiente recolector / Saco recolector de papel lleno"

Se enciende cuando el recipiente recolector /saco recolector para papel está lleno y se tiene que vaciar. El mecanismo de corte para el desmenuzamiento de papel se desconecta.

11 = Ranura de alimentación de papel (Fig. 3)

12 = Recipiente recolector (Fig. 4)

13 = Saco recolector para papel (Fig. 4)

14 = Botellita de aceite (Fig. 4)



La destructora no se debe utilizar nunca como asiento ni como taburete. ¡Peligro de caída por rotura de material!

CÓMO CONECTAR EL APARATO:

Para conectar el aparato en "listo para el uso" proceda como sigue:

- Accione brevemente el pulsador funcional (2).
- El indicador piloto del pulsador \odot funcional (2) se encenderá para la función "Listo para el uso".
- A continuación se puede empezar a alimentar el aparato con papel.

ALIMENTACIÓN DE MATERIAL:

Introduzca **papel** por la ranura de alimentación de papel (11) (Fig. 3) al mecanismo de corte.

El aparato se conecta automáticamente a la marcha de avance, mete el material y se desconecta automáticamente después de haber finalizado la etapa de desmenuzamiento.

Notas: Para el desmenuzamiento de láminas transparentes se tiene que conectar la máquina a mano en el modo de funcionamiento de avance (mantenga accionado el pulsador de avance (3) durante unos 2 segundos). Accionando brevemente el pulsador funcional (2) (función de "Parada") se puede detener en todo momento la etapa de desmenuzamiento. Para continuar, mantenga accionado el pulsador de avance (3) durante 2 segundos. Si la máquina no se utiliza durante un periodo de tiempo de aprox. 5 min. se desconecta.



¡No introduzca nunca en el aparato más material del indicado como máximo (consulte el apartado "DATOS TÉCNICOS")!

En el caso de que se haya introducido de todos modos demasiado material en el mecanismo de corte, consulte en "AVERÍAS" en el apartado "MATERIAL ATASCADO EN EL APARATO".

CÓMO VACIAR EL RECIPIENTE RECOLECTOR / SACO RECOLECTOR PARA PAPEL (Fig. 4):

En cuanto el recipiente recolector /saco recolector se haya llenado de papel, el aparato se desconectará. El indicador de control \square (10) se enciende. Proceda como sigue:

- Abra la puerta. El indicador de control \square (8) se

enciende. Si aún queda material en la ranura de alimentación, el indicador de control \odot (6) se encenderá también ahora.

RECIPIENTE RECOLECTOR (12):

- Extraiga el recipiente recolector de la parte inferior de la carcasa y vacíe el contenido. El indicador de control \square (10) se apaga.
- Vuelva a introducir el recipiente recolector vaciado (12) en la parte inferior de la carcasa y cierre la puerta. El indicador de control \square (8) se apaga.
- Si el indicador de control \odot (6) está encendido, confirme brevemente con el pulsador de avance (3). El material que se había quedado en la ranura de alimentación es desmenuzado y el indicador se apaga.

SACO RECOLECTOR PARA PAPEL (13):

- Saque el saco recolector junto con el marco contenido en la unidad inferior de la carcasa, retire el saco y elimine el contenido. El indicador de control \square (10) se apaga.
- Cuelgue el saco vaciado en el marco del saco y vuelva a introducir el saco con marco en la unidad inferior de la carcasa. Cierre la puerta. El indicador de control \square (8) se apaga.
- Si el indicador de control \odot (6) está encendido, confirme brevemente con el pulsador de avance (3). El material que se había quedado en la ranura de alimentación es desmenuzado y el indicador se apaga.

Nota: ¡La máquina sólo funciona con la puerta cerrada!

INDICADOR DINÁMICO DE CARGA:

A fin de evitar el atasco de material y, por lo tanto, lograr una destrucción continuada y efectiva de los soportes de datos, se indica - durante la etapa de desmenuzamiento - el grado momentáneo de carga del motor mediante una luz difusa, determinada por el color, en la ranura de alimentación, como sigue:

Luz verde:	Carga < 50%
Luz amarilla:	Carga 50 -75%
Luz roja:	Carga 75 -100%

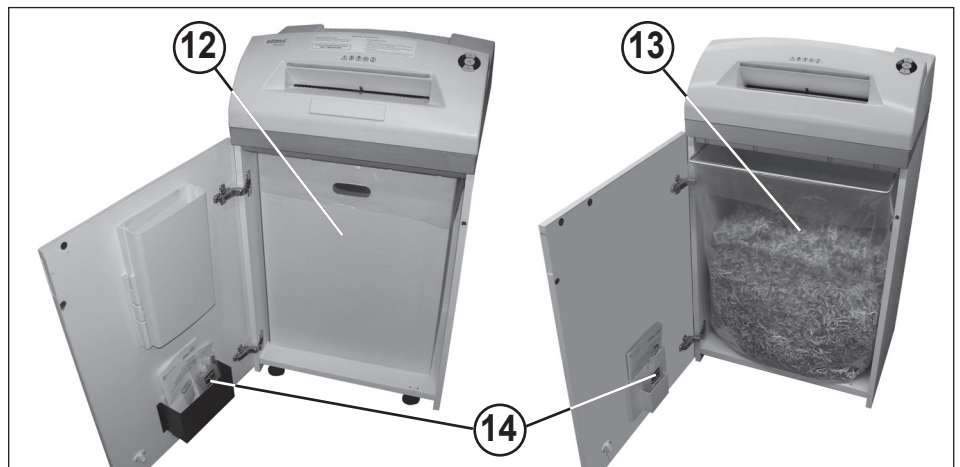

Fig. 4

AVERIA

MATERIAL ATASCADO EN EL APARATO: (Función de auto-retroceso)

Si se produce un atasco debido a un exceso de material introducido, el aparato reacciona como sigue:

- El mecanismo de corte se bloquea, retrocede a continuación un poco (material se libera) y se para. El motor se desconecta. El indicador de control (6) se enciende.

Proceda como sigue:

Papel atascado en la ranura de alimentación de papel (11)

- Retire el papel retrocedido.
- Una vez hecho esto, el mecanismo de corte avanzará automáticamente y desmenuzará el resto de papel contenido en el mecanismo de corte. El indicador piloto integrado del pulsador de avance (3) está encendido durante el avance. El indicador de control (6) se apaga.
- Continúe con el desmenuzamiento introduciendo una cantidad menor de papel.
- Si fuera necesario, conecte el mecanismo de corte a mano, alternando entre avance y retroceso, hasta que el material haya pasado por el mecanismo de corte y se haya desmenuzado.

BARRERA FOTOELÉCTRICA TAPADA POR APERTURA DE PUERTA:

Si al abrir la puerta se encontrara aún material en la ranura de alimentación, el motor se desconectará y el mecanismo de corte se parará. El indicador de control (6) se enciende.

Cierre la puerta y confirme la situación accionando brevemente el pulsador de avance (3). El material restante se introducirá en el mecanismo de corte para ser desmenuzado.

BARRERA FOTOELÉCTRICA TAPADA POR CONEXIÓN:

Si al conectar la máquina hubiera material en la ranura de alimentación, el indicador de control se enciende (6).

Retire el material y confirme la situación accionando brevemente el pulsador de avance (3).

GUARDAMOTOR:

Si el motor se sobrecarga, se desconectará.

Deje enfriar el aparato unos 25-40 minutos y vuelva a activar entonces el aparato.

AVERÍA ELÉCTRICA:

Si el indicador de control (9) **parpadea** en combinación con el indicador piloto del interruptor funcional (2) o sólo el indicador de control (8), significa que ha surgido una avería eléctrica. Con lo que el aparato no se puede activar.

Avise en este caso al comercio especializado más cercano.

LISTA DE VERIFICACIÓN EN LAS AVERÍAS:

Si el aparato no funciona, compruebe los siguientes puntos:

- ¿Se ha conectado la **clavija de enchufe** a la red de corriente eléctrica?
- ¿Está la **puerta cerrada**?
- ¿Está el **saco recolector de papel** lleno? Siga las instrucciones en el apartado "CÓMO VACIAR EL SACO RECOLECTOR".
- ¿Hay **material atascado** en el aparato? Siga las instrucciones en el apartado "MATERIAL ATASCADO EN EL APARATO".
- ¿Se ha sobrecargado el **motor**? Consulte el apartado "GUARDAMOTOR".

Si su aparato presenta otro problema distinto a los alistados anteriormente, notifíquelo al comercio especializado más cercano.

MANTENIMIENTO / ELIMINACIÓN



¡Antes de efectuar reparaciones así como la limpieza y el mantenimiento, que no estén descritos explícitamente en el texto siguiente, desenchufe la clavija!



LIMPIEZA DE LAS FOTOCÉLULAS:

En el caso de que se hayan quedado papeles adheridos en la ranura de entrada (p. ej. tras un atasco de papel) es posible que el aparato no se desconecte a causa de la fotocélula "tapada".

Puede retirar los trozos de papel o bien limpiar la fotocélula, alimentando el mecanismo de corte con una hoja de papel adicional, o activar la marcha de retroceso del aparato pasando, a continuación, brevemente un pincel sobre ambas "ópticas" de la fotocélula.

MANTENIMIENTO DEL MECANISMO DE CORTE (CORTE CRUZADO/CROSS-CUT):

Después de haber transcurrido un determinado tiempo de servicio, se deberá aplicar aceite en los mecanismos de corte cruzado. Si el indicador de control está encendido (7), proceda como sigue:

Abra la puerta. El indicador de control (8) se enciende y el indicador piloto del pulsador de retroceso (4) así como el indicador de control (7) **parpadean**. Tome la botellita de aceite (14) (Fig. 4) situada en el soporte de la puerta y vuelva a cerrar la puerta.

Distribuya un poco de aceite sobre una hoja de papel y, a continuación, introduzca la por la ranura de alimentación de papel (11) al mecanismo de corte.

El papel se mete y el aceite penetrará así en el mecanismo de corte.

Nota: Para borrar el indicador, habrá que confirmar este proceso, después de haber engrasado el mecanismo de corte, como sigue:

- Abra la puerta hasta que el indicador de control (8) se encienda. Los indicadores de control (7) y (4) **parpadean**.

- Accione el pulsador de retroceso (4) y no lo suelte hasta que el indicador de control (7) se apague.
- Cierre la puerta de nuevo.

Una vez hecho esto, el mecanismo de corte comenzará automáticamente un ciclo de limpieza (avance/retroceso) y, a continuación, se desconecta. La máquina vuelve a estar lista para el uso. Si desea pedir el aceite especial, consulte el apartado "ACCESORIOS ESPECIALES".

FUNCIÓN AUTOMÁTICA DE AHORRO ENERGÉTICO:

Si el aparato no se utiliza durante algún tiempo, se desconectará automáticamente tras unos 5 min. El indicador piloto del pulsador funcional (2) para "Listo para el uso" se apaga. Accione brevemente el pulsador funcional para reconectar.

ELIMINACIÓN DEL APARATO USADO:



Elimine el aparato usado al final de su vida útil respetando siempre las normas medioambientales. No tire las partes de la máquina ni el embalaje con la basura doméstica.

DATOS TÉCNICOS

Modelo	Tipo	Ancho de corte papel	Rendimiento de corte papel	Ancho de trabajo	Nivel de ruidos	Dimensiones A x F x A	Peso
intimus 120SP2(SC2)	227-6S	5,8 mm	35-38 hojas*	310 mm	aprox. 57 dB(A)	535 x 395 x 980 mm	46 kg
intimus 120SP2(SC2)	227-4S	3,8 mm	31-33 hojas*	310 mm	aprox. 57 dB(A)	535 x 395 x 980 mm	46 kg
intimus 120CP4(CC3)	227-4C	3,8x36 mm	23-25 hojas*	310 mm	aprox. 57 dB(A)	535 x 395 x 980 mm	47 kg
intimus 120CP5(CC4)	227-2C	1,9x15 mm	15-17 hojas*	310 mm	aprox. 57 dB(A)	535 x 395 x 980 mm	47 kg
intimus 120CP6(CC5)	227-1C	0,8x12 mm	10-12 hojas*	310 mm	aprox. 57 dB(A)	535 x 395 x 980 mm	47 kg
intimus 120CP7(CC6)	227-1CF	0,8x4,5 mm	7-8 hojas*	310 mm	aprox. 57 dB(A)	535 x 395 x 980 mm	47 kg

Fusible previo (lento): 220-230V = 10 A / 120V = 15 A / 100V = 18 A

* referido a papel formato A4 70g/m² a 230V/50Hz

Modelo	Datos de conexión a la red		
	tensión de conexión/frecuencia · consumo de corriente · potencia		
intimus 120SP2(SC2)	220-230V/50Hz · 7,8 A · 1,8 kW	120V/60Hz · 12,0 A · 1,4 kW	100V/50/60Hz · 18,0 A · 1,8 kW
intimus 120SP2(SC2)	220-230V/50Hz · 7,8 A · 1,8 kW	120V/60Hz · 12,0 A · 1,4 kW	100V/50/60Hz · 18,0 A · 1,8 kW
intimus 120CP4(CC3)	220-230V/50Hz · 7,8 A · 1,8 kW	120V/60Hz · 12,0 A · 1,4 kW	100V/50/60Hz · 18,0 A · 1,8 kW
intimus 120CP5(CC4)	220-230V/50Hz · 7,8 A · 1,8 kW	120V/60Hz · 12,0 A · 1,4 kW	100V/50/60Hz · 18,0 A · 1,8 kW
intimus 120CP6(CC5)	220-230V/50Hz · 7,8 A · 1,8 kW	120V/60Hz · 12,0 A · 1,4 kW	100V/50/60Hz · 18,0 A · 1,8 kW
intimus 120CP7(CC6)	220-230V/50Hz · 7,8 A · 1,8 kW	120V/60Hz · 12,0 A · 1,4 kW	100V/50/60Hz · 18,0 A · 1,8 kW

ACCESORIO

Denominación	Nº de pedido
Saco de plástico, 440x330x950x0,05 mm	99977
Botellita de aceite, 110 ml	88035



Iniciación: En el caso de pedidos ulteriores de accesorios especiales y de piezas de repuesto, rogamos se dirija a nuestro representante oficial.

INSTRUÇÕES DE SEGURANÇA IMPORTANTES

 << O aparelho não deve ser manejado por várias pessoas ao mesmo tempo! Os elementos de segurança servem para um manejo sem perigo no „serviço por um só operador“.

 << Durante a operação de corte de papel não devem ser realizados outros trabalhos na máquina (por exemplo limpezas, etc.)!

 << A máquina **não é brinquedo e não é apropriada para a utilização por crianças!** Os aspectos de técnica de segurança (dimensões, aberturas de alimentação, dispositivos de desligamento de segurança, etc.) desta máquina não implicam qualquer garantia de manuseio seguro por crianças.





  << **Risco de ferimento!** Manter peças de vestuários pendentes, gravatas, jóias, cabelos compridos ou outros objectos pendentes afastados da abertura para alimentação!

 << **Risco de ferimento!** Não colocar as mãos na abertura para alimentação!

 << Em caso de perigo, desligar a máquina no interruptor principal, ou desligar a ficha da tomada!

 << Antes de abrir a máquina deve desligar a ficha da tomada! Todas as reparações devem ser executadas por especialistas!

Materiais especiais

Model	Symbol 	Symbol 	Symbol 	Symbol 
120SP2 (SC2)-3,8				X
120SP2 (SC2)-5,8				X
120CP4 (CC3)				X
120CP5 (CC4)				X
120CP6 (CC5)	X		X	X
120CP7 (CC6)	X	X	X	X

X = inapropriado para trituração

 **Atenção:** Perigo de contusões e golpes devido a peças móveis!

 **Atenção:** Risco de ferimento devido a tensão eléctrica!

ENTRADA EM FUNCIONAMENTO

ÁREA DE APLICAÇÃO:

A trituradora intimus 120 SP2(SC2)/CP4(CC3)/CP5(CC4)/CP6(CC5)/CP7(CC6) é uma máquina para cortar todo o tipo de material próprio para escrita.

 **A máquina só deve ser empregada para a trituração de papel (divergências: veja tabela sob „Materiais especiais“)! A trituração de outros suportes de dados pode provocar ferimentos em pessoas (por ex. devido ao estilhaçamento de produtos, etc.), assim como, danos na máquina (por ex. destruição das lâminas, etc.).**

INSTALAÇÃO:





- Desembale a máquina e instale-a.
- Pendure o saco de plástico na respectiva armação.
- Utilizando o cabo de corrente fornecido, ligue a fonte de alimentação do aparelho à tomada de corrente alternada (para indicações sobre o fusível de entrada necessário da tomada de rede, veja “DADOS TÉCNICOS”).

 **A ligação à rede eléctrica da máquina tem de estar acessível, desimpedida e perto da máquina! A máquina só deve ser usada em espaços fechados e com uma temperatura amena (10 - 25 °C)! Instalar a máquina sempre com uma distância suficiente em relação à parede do local.**

UTILIZAÇÃO

ELEMENTOS DE COMANDO:

- 1 = Ficha de ligação à rede (Fig. 2)**
Quando se liga a máquina com a respectiva ficha à rede eléctrica, ela fica em estado de desligado.
- 2 = Botão das funções (Fig. 1)**
“Operacional”/“Desligar”/“Parar”
Este botão inclui três funções:
 - “Operacional”**
Com um breve toque neste botão, a máquina fica em estado “Operacional”.
Ao mesmo tempo, acende-se o indicador LED integrado .
 - “Desligar”**
Mantendo este botão premido no estado “Operacional” durante aprox. 3 segundos, a máquina desliga-se.
Nota: Se a máquina não for usada durante aprox. 5 minutos, desliga-se automaticamente.
 - “Parar”**
Com um breve toque neste botão, estando o mecanismo de corte a funcionar, este desliga-se e pára.

- 3 = Botão de avanço (Fig. 1)**
Este botão inclui duas funções:
 - Com um breve toque neste botão, o mecanismo de corte avança durante alguns segundos, por ex. para fazer sair o material cortado que tenha aí ficado. Ao mesmo tempo, acende-se o indicador LED integrado .
 - Se este botão for mantido premido durante aprox. dois segundos, o mecanismo de corte gira continuamente para a frente e a máquina pode ser alimentada. Ao mesmo tempo, acende-se o indicador LED integrado .
- 4 = Botão de retrocesso (Fig. 1)**
Premindo este botão, o mecanismo de corte gira, por instantes, para trás. Ao mesmo tempo, acende-se o indicador LED integrado .
- 5 = Dispositivo fotoeléctrico (avanço) (Fig. 3)**
Inicia o processo de trituração assim que é introduzido material na ranhura de alimentação. Ao mesmo tempo, acende-se o indicador LED  do botão de avanço.

- 6 = Indicador de controlo (Fig. 1)**
“Congestionamento de material no aparelho”/“Dispositivo fotoeléctrico ocupado ao se abrir a porta ou ao ligar”
Para a descrição do procedimento, ver na rubrica “FALHA”.
 - “Congestionamento de material no aparelho”**
Acende-se quando é fornecido demasiado material ao mecanismo de corte. O mecanismo de corte bloqueia, gira um pouco para trás e pára. O motor desliga-se.
 - “Dispositivo fotoeléctrico ocupado ao se abrir a porta”**
Acende-se quando, ao abrir a porta, ainda há material na ranhura de alimentação. O mecanismo de corte pára. O motor desliga-se.
 - “Dispositivo fotoeléctrico ocupado ao ligar”**
Acende-se quando, ao ligar a máquina, há material na ranhura de alimentação.

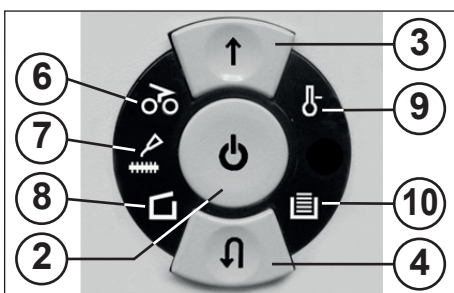

Fig. 1

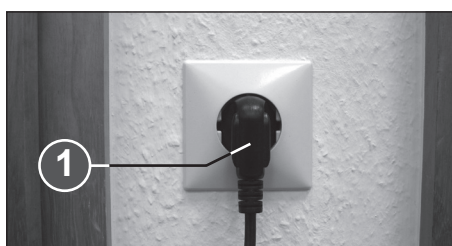

Fig. 2

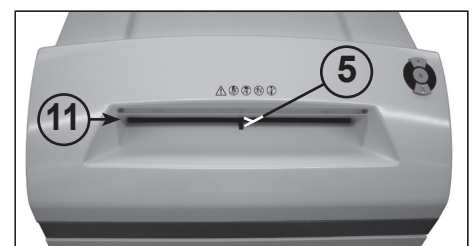

Fig. 3

UTILIZAÇÃO

ELEMENTOS DE COMANDO:

7 = Indicador de controlo (Fig. 1)

“Olear o mecanismo de corte”

Acende-se quando o mecanismo de corte da versão de corte cruzado (“cross-cut”) precisa de ser oleado. A lubrificação tem de ser confirmada com o botão de retrocesso (4) (veja a descrição em “MANUTENÇÃO DO MECANISMO DE CORTE”).

8 = Indicador de controlo (Fig. 1)

“Porta aberta”/“Falha na porta”

a) “Porta aberta”

Acende-se quando a porta do armário inferior está aberta. A máquina desliga-se automaticamente e não se pode voltar a ligar enquanto a porta estiver aberta.

b) “Falha eléctrica”

Pisca se houver alguma falha eléctrica nos sensores da porta. A máquina desliga-se. Informe o vendedor autorizado.

9 = Indicador de controlo (Fig. 1)

Para a descrição do procedimento, ver na rubrica “FALHA”.

“Falha eléctrica”

Pisca se houver alguma falha eléctrica na placa de circuitos impressos. Ao mesmo tempo, o indicador LED do interruptor de funcionamento (2) pisca. A máquina desliga-se. Informe o vendedor autorizado.

10 = Indicador de controlo (Fig. 1)

“Depósito colector / Saco colector de papel cheio”

Acende-se quando o depósito colector / saco colector de papel está cheio e precisa de ser esvaziado. O mecanismo de corte para destruição de papel desliga-se.

11 = Ranhura de alimentação de papel (Fig. 3)

12 = Depósito colector (Fig. 4)

13 = Saco colector de papel (Fig. 4)

14 = Recipiente de óleo (Fig. 4)



A desfibradora nunca pode ser usada para alguém se sentar ou subir para cima dela. Perigo de queda devido à ruptura de material!

LIGAR A MÁQUINA:

Para ligar a máquina no modo “Operacional”, proceda da seguinte forma:

- Prima por instantes o botão das funções (2).
- O indicador LED do botão das funções (2) acende-se para indicar o modo “Operacional”.
- A máquina pode ser alimentada.

ALIMENTAÇÃO DE MATERIAL:

Alimentar o mecanismo de corte com papel através da ranhura de alimentação de papel (11) (Fig. 3).

A máquina activa automaticamente a rotação para a frente e puxa o material, desligando-se automaticamente depois do processo de destruição.

Nota: Para a destruição de películas transparentes, a máquina tem de ser mudada manualmente para a rotação para a frente (mantenha premido o botão de avanço (3) durante, aprox., 2 segundos).

Com um breve toque no botão das funções (2) (função “Parar”), o processo de destruição pode ser parado em qualquer altura. Para continuar, mantenha premido o botão de avanço (3) durante, aprox., 2 segundos.

Se a máquina não for usada durante aprox. 5 minutos, desliga-se automaticamente.



Nunca alimente o aparelho com uma quantidade de material superior à máxima indicada (veja “DADOS TÉCNICOS”)!

Se, mesmo assim, alguma vez entrar demasiado material no mecanismo de corte, veja “FALHA”, em “CONGESTIONAMENTO DE MATERIAL NO APARELHO”.

ESVAZIAR O DEPÓSITO COLECTOR / SACO COLECTOR PARA PAPEL (Fig. 4):

Quando o depósito colector / saco colector para papel estiver cheio, a máquina desliga-se. O indicador de controlo (10) acende-se. Proceda da seguinte forma:

- Abra a porta. O indicador de controlo (8) acende-se. Se ainda houver material na ranhura de alimentação, o indicador de controlo (6) também se acende.

DEPÓSITO COLECTOR (12):

- Retire da parte inferior da caixa o depósito colector e esvazie-o. O indicador de controlo (10) apaga-se.
- Encaixe o depósito colector esvaziado (12) novamente na parte inferior da caixa e feche a porta. O indicador de controlo (8) apaga-se.
- Se o indicador de controlo (6) estiver aceso, prima o botão de avanço (3) por instantes. O material restante na ranhura de alimentação é destruído e o indicador apaga-se.

SACO COLECTOR PARA PAPEL (13):

- Puxe o saco colector com a respectiva armação da parte inferior da caixa, retire-o e elimine o conteúdo. O indicador de controlo (10) apaga-se.
- Pendure o saco vazio na armação e volte a introduzir ambos na parte inferior da caixa. Feche a porta. O indicador de controlo (8) apaga-se.
- Se o indicador de controlo (6) estiver aceso, prima o botão de avanço (3) por instantes. O material restante na ranhura de alimentação é destruído e o indicador apaga-se.

Nota: A máquina só funciona com a porta fechada!

INDICAÇÃO DINÂMICA DA CARGA:

Para evitar um congestionamento de material e conseguir, assim, uma inutilização contínua e eficaz dos suportes de dados, durante o processo de destruição, é indicado o grau de carga do motor nesse momento através de uma luz difusa com a cor apropriada na ranhura de alimentação:

Luz verde:	Carga < 50 %
Luz amarela:	Carga 50 % - 75 %
Luz vermelha:	Carga 75 % - 100%

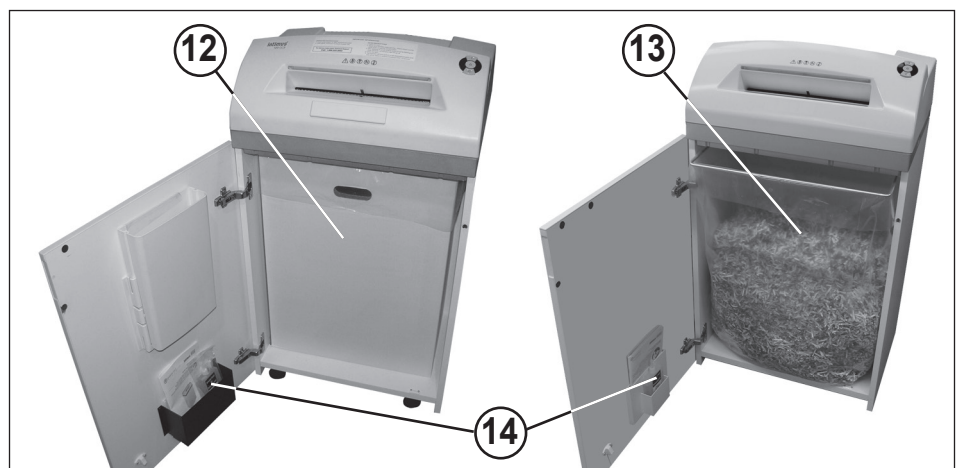

Fig. 4

AVARIAS

CONGESTIONAMENTO DE MATERIAL NO APARELHO: (Função Auto-Reverse)

Em caso de congestionamento devido a fornecimento de demasiado material, a máquina reage da seguinte forma:

- O mecanismo de corte bloqueia, retrocede um pouco (o material é desbloqueado) e pára. O motor desliga-se. O indicador de controlo (6) acende-se.

Proceda da seguinte forma:

Congestionamento de papel na respectiva ranhura de alimentação (11)

- Retire o papel reconduzido.
- O mecanismo de corte gira agora automaticamente para a frente e destrói o papel que resta no mecanismo de corte. Durante a rotação para a frente, o indicador LED (3) do botão de avanço (3) acende-se. O indicador de controlo (6) apaga-se.
- Continue a destruição com menos quantidade de papel.
- Se necessário, vá alternando manualmente entre rotação para a frente e para trás do mecanismo de corte até todo o material estar completamente inserido e destruído.

DISPOSITIVO FOTOELÉCTRICO OCUPADO AO SE ABRIR A PORTA:

Se, ao abrir a porta, ainda houver material na ranhura de alimentação, o motor desliga-se e o mecanismo de corte pára. O indicador de controlo (6) acende-se.

Feche a porta e confirme o estado premindo o botão de avanço (3) por instantes. O material de corte existente é conduzido ao mecanismo de corte e destruído.

DISPOSITIVO FOTOELÉCTRICO OCUPADO AO LIGAR:

Se, ao ligar a máquina, houver material na ranhura de alimentação, o indicador de controlo (6) acende-se.

Retire o material e confirme o estado premindo o botão de avanço (3) por instantes.

PROTECÇÃO DO MOTOR:

Se estiver sobrecarregado, o motor desliga-se. Após um período de arrefecimento de aprox. 25 a 40 minutos, pode voltar a ligar o aparelho.

FALHA ELÉCTRICA:

Se o indicador de controlo (9) piscar juntamente com o indicador LED (1) do botão das funções (2) ou apenas o indicador de controlo (8), é porque há uma falha eléctrica. Não é possível colocar a máquina em funcionamento.

Neste caso, informe o seu revendedor autorizado.

LISTA DE CONTROLO EM CASO DE FALHA:

Se o aparelho não funcionar, verifique os seguintes pontos:

- A **ficha** está ligada à rede?
- A **porta** está fechada?
- O **saco colector de papel** está cheio? Siga as instruções em "ESVAZIAR O SACO COLECTOR PARA PAPEL".
- Há **congestionamento de material** no aparelho? Siga as instruções em "CONGESTIONAMENTO DE MATERIAL NO APARELHO".
- O **motor** ficou sobrecarregado? Veja em "PROTECÇÃO DO MOTOR".

Se nenhum destes pontos de verificação se aplicar, informe o seu revendedor autorizado.

MANUTENÇÃO / DISPOSIÇÃO

 **Antes da realização de todos os trabalhos de reparação, bem como dos trabalhos de limpeza e manutenção, que não se encontrem descritos em particular no texto que se segue, desligar o cabo de alimentação!**



LIMPEZA DAS CÉLULAS FOTOELÉCTRICAS:

Se ficarem pedaços de papel na ranhura de alimentação (por ex. depois de um congestionamento de papel) é possível que o aparelho já não se desligue porque o dispositivo fotoeléctrico detecta o estado "ocupado".

Pode retirar os pedaços de papel ou limpar a célula fotoeléctrica introduzindo mais uma folha de papel no mecanismo de corte ou activando a rotação inversa da máquina e, com um pincel, limpar por instantes o dois "olhos" da célula fotoeléctrica.

MANUTENÇÃO DO MECANISMO DE CORTE CRUZADO ("CROSS-CUT"):

Os mecanismos de corte cruzado ("cross-cut") têm de ser lubrificados depois de um determinado tempo de operação. Se o indicador de controlo (7) se acender, proceda da seguinte forma:

Abra a porta. O indicador de controlo (8) acende-se e o indicador LED (4) do botão de retrocesso (4), bem como o indicador de controlo (7) piscam. Retire o recipiente de óleo (14) (Fig. 4) do suporte da porta e volte a fechá-la.

Distribua um pouco de óleo numa folha de papel e introduza-a no mecanismo de corte pela ranhura de alimentação de papel (11).

O papel é puxado e o óleo entra no mecanismo de corte.

Nota: Para apagar a indicação, depois de lubrificar o mecanismo de corte, confirme o procedimento desta forma:

- Abra a porta até o indicador de controlo (8) se acender. Os indicadores de controlo (7) e (4) piscam.

- Mantenha premido o botão de retrocesso (4) até o indicador de controlo (7) se apagar.

- Volte a fechar a porta. O mecanismo de corte inicia automaticamente um ciclo de limpeza (rotação para a frente e para trás) e desliga-se. A máquina volta ao estado operacional. Para encomendar o óleo especial, consulte "ACESSÓRIOS ESPECIAIS".

ECONOMIZAÇÃO AUTOMÁTICA DE ENERGIA:

Se a máquina não for usada durante algum tempo, desliga-se automaticamente depois de aprox. 5 min. O indicador LED (1) do botão das funções (2) do modo "Operacional" apaga-se. Para a voltar a ligar, prima por instantes o botão das funções.

ELIMINAR A MÁQUINA:

 No fim da sua vida útil, elimine a máquina da forma menos prejudicial para o ambiente. Não deite nenhuma peça da máquina nem da embalagem no lixo doméstico.

DADOS TÉCNICOS

Modelo	Tipo	Largura do corte papel	Produtividade do corte papel	Largura de trabalho	Nível de ruído	Dimensões L x P x A	Peso
intimus 120SP2(SC2)	227-6S	5,8 mm	35-38 folhas*	310 mm	57 dB(A) (aprox)	535 x 395 x 980 mm	46 kg
intimus 120SP2(SC2)	227-4S	3,8 mm	31-33 folhas*	310 mm	57 dB(A) (aprox)	535 x 395 x 980 mm	46 kg
intimus 120CP4(CC3)	227-4C	3,8x36 mm	23-25 folhas*	310 mm	57 dB(A) (aprox)	535 x 395 x 980 mm	47 kg
intimus 120CP5(CC4)	227-2C	1,9x15 mm	15-17 folhas*	310 mm	57 dB(A) (aprox)	535 x 395 x 980 mm	47 kg
intimus 120CP6(CC5)	227-1C	0,8x12 mm	10-12 folhas*	310 mm	57 dB(A) (aprox)	535 x 395 x 980 mm	47 kg
intimus 120CP7(CC6)	227-1CF	0,8x4,5 mm	7-8 folhas*	310 mm	57 dB(A) (aprox)	535 x 395 x 980 mm	47 kg

Segurança (ociosa): 220-230V = 10 A / 120V = 15 A / 100V = 18 A

* Referente a papel A4 70g/m² com 230V/50Hz

Modelo	Dados de conexão à rede		
	Tensão de conexão/Frequência · Consumo de corrente · potência		
intimus 120SP2(SC2)	220-230V/50Hz · 7,8 A · 1,8 kW	120V/60Hz · 12,0 A · 1,4 kW	100V/50/60Hz · 18,0 A · 1,8 kW
intimus 120SP2(SC2)	220-230V/50Hz · 7,8 A · 1,8 kW	120V/60Hz · 12,0 A · 1,4 kW	100V/50/60Hz · 18,0 A · 1,8 kW
intimus 120CP4(CC3)	220-230V/50Hz · 7,8 A · 1,8 kW	120V/60Hz · 12,0 A · 1,4 kW	100V/50/60Hz · 18,0 A · 1,8 kW
intimus 120CP5(CC4)	220-230V/50Hz · 7,8 A · 1,8 kW	120V/60Hz · 12,0 A · 1,4 kW	100V/50/60Hz · 18,0 A · 1,8 kW
intimus 120CP6(CC5)	220-230V/50Hz · 7,8 A · 1,8 kW	120V/60Hz · 12,0 A · 1,4 kW	100V/50/60Hz · 18,0 A · 1,8 kW
intimus 120CP7(CC6)	220-230V/50Hz · 7,8 A · 1,8 kW	120V/60Hz · 12,0 A · 1,4 kW	100V/50/60Hz · 18,0 A · 1,8 kW

ACESSÓRIOS

Designação **Nº de encomenda**
Saco de plástico, 440x330x950x0,05 mm **99977**
Frasco de óleo, 110 ml **88035**
Indicação: No caso de encomendar mais tarde peças dos acessórios especiais e no caso de necessitar peças de reposição, dirija-se ao seu revendedor especializado.



International Network

Germany	intimus International GmbH Bergheimer Straße 6-12 88677 Markdorf / Bodensee	+49 (0) 7544 60-0 sales.de@intimus.com
North America	intimus North America 251 Wedcore Avenue Wabash, IN 46992	(800) 775 2122 sales.us@intimus.com
France	intimus International GmbH Bergheimer Straße 6-12 88677 Markdorf / Bodensee	+33 (6) 14 59 19 41 +33 (6) 12 44 59 05 sales.de@intimus.com
P.R. China	intimus International Trading (Beijing) Limited Room 260D, C Building Guojigang No.E-2 Dong San Huan Bei Road, Chaoyang District, Beijing 100027, PRC	+86 (0) 10 84 47 10 71 / 72 / 73 info@intimus.com.cn
Austria	intimus International Austria Ges. m. b. H. Ernst Melchior Gasse 20, 4. OG Top 6 1020 Wien	+ 43 (0)1 2583621 0 contact.at@intimus.com
Belgium	intimus International Belgium NV Wayenborgstraat 22, 2800 Mechelen	+32 (0)15 - 29 46 30 infobel@intimus.com
Netherlands	intimus International Netherlands, B.V. Rivium Quadrant 2, 6e verdieping 2909 LC Capelle aan den IJssel	+31 (0)10 - 242 11 00 informatie@intimus.com
Luxemburg	intimus International Luxembourg S. à.r.l. Route des Trois Cantons 9 , Ground Floor 8399 Luxembourg	+352 (0)26 - 10 88 66 infolux@intimus.com
Portugal	intimus International Portugal IIG Mailing and Information Security Portugal Sociedade Unipessoal LDA. Rua Alfredo Lopes Villaverde, 15-B, Escritorio 4, Paço de Arcos e Caixas 2770-009 Lisboa	+351 214 415 153 pt@intimus.com
Spain	intimus International Ibérica, S.A. Antón Fortuny, 14, 16 esc. C1º 1ª Esplugues de Llobregat 08950 Barcelona	+34 93 480 33 10 info.es@intimus.com
Other Countries	intimus International GmbH Bergheimer Straße 6-12 88677 Markdorf / Bodensee	+49 (0) 7544 60-0 sales.de@intimus.com



Dieses Papier ist aus 100 % Altpapier ohne optische Aufheller hergestellt.
This paper made from 100 % unbleached recycled paper.
Papier recyclable à 100 %.