

Always there to help you

Register your product and get support at
www.philips.com/support

AZB798T



User manual

PHILIPS

Contents

| | |
|--------------------|---|
| 1 Important | 2 |
| Hearing safety | 2 |

| | |
|--------------------------------|---|
| 2 Your CD Soundmachine | 3 |
| Introduction | 3 |
| What's in the box | 3 |
| Overview of the main unit | 4 |
| Overview of the remote control | 5 |

| | |
|----------------------------|---|
| 3 Get started | 7 |
| Prepare the remote control | 7 |
| Connect power | 7 |
| Turn on | 8 |
| Turn off | 8 |

| | |
|-------------------------------------|----|
| 4 Play | 9 |
| Play CD | 9 |
| Play from USB devices | 9 |
| Play from Bluetooth-enabled devices | 9 |
| Play tape | 10 |
| Play from an external device | 11 |

| | |
|-----------------------|----|
| 5 Play options | 12 |
| Control play | 12 |
| Program tracks | 12 |
| Adjust sound | 12 |

| | |
|------------------------------------|----|
| 6 Listen to FM radio | 13 |
| Tune to FM radio stations | 13 |
| Store radio stations automatically | 13 |
| Store radio stations manually | 13 |
| Select a preset radio station | 13 |

| | |
|---------------------------------------|----|
| 7 Listen to DAB radio stations | 14 |
| Listen to DAB radio stations | 14 |
| For the first time use | 14 |
| Program radio stations | 14 |
| Display DAB information | 14 |
| Use DAB menus | 14 |

| | |
|------------------------------------|----|
| 8 Use system menus | 16 |
| Reset the product | 16 |
| Check the current software version | 16 |

| | |
|-------------------------------|----|
| 9 Other features | 17 |
| Set the sleep timer | 17 |
| Adjust the display brightness | 17 |
| Listen through the headphone | 17 |

| | |
|-------------------------------|----|
| 10 Product information | 18 |
| Specifications | 18 |
| Supported MP3 disc formats | 19 |
| USB playability information | 19 |
| Maintenance | 19 |

| | |
|---------------------------|----|
| 11 Troubleshooting | 21 |
|---------------------------|----|

| | |
|-------------------------|----|
| 12 Notice | 22 |
| Compliance | 22 |
| Care of the environment | 22 |
| Trademark notice | 22 |

1 Important



Warning

- Never remove the casing of this apparatus.
 - Never lubricate any part of this apparatus.
 - Never look into the laser beam inside this apparatus.
 - Never place this apparatus on other electrical equipment.
 - Keep this apparatus away from direct sunlight, naked flames or heat.
 - Ensure that you always have easy access to the power cord, plug or adaptor to disconnect the apparatus from the power.
-
- The device shall not be exposed to dripping or splashing.
 - Do not place any source of danger on the device (e.g. liquid filled objects, lit candles).
 - Where the MAINS plug or an appliance coupler is used as the disconnect device, the disconnect device shall remain readily operable.
 - Make sure that there is enough free space around the product for ventilation.
 - Battery usage CAUTION – To prevent battery leakage which may result in bodily injury, property damage, or damage to the unit:
 - Install all batteries correctly, + and - as marked on the unit.
 - Batteries (packed or installed) shall not be exposed to excessive heat such as sunshine, fire or the like.
 - Remove batteries when the unit is not used for a long time.
 - Only use attachments/accessories specified by the manufacturer.



Warning

- Never remove the casing of this apparatus.
- Never place this apparatus on other electrical equipment.
- Never look into the laser beam inside this apparatus.

Hearing safety



Caution

- To avoid hearing damage, limit the time you use the headphones at high volume and set the volume to a safe level. The louder the volume, the shorter is the safe listening time.

Be sure to observe the following guidelines when using your headphones.

- Listen at reasonable volumes for reasonable periods of time.
- Be careful not to adjust the volume as your hearing adapts.
- Do not turn up the volume so high that you can't hear what's around you.
- You should use caution or temporarily discontinue use in potentially hazardous situations.
- Excessive sound pressure from earphones and headphones can cause hearing loss.



Caution

- Use of controls or adjustments or performance of procedures other than herein may result in hazardous laser exposure or other unsafe operation.

2 Your CD Soundmachine

Introduction

With this CD Soundmachine, you can:

- listen to FM radio;
- enjoy audio from tapes, USB device, Bluetooth devices, and other external audio devices;
- program the play sequence of tracks.

The unit offers you Dynamic Bass Boost (DBB) and Digital Sound Control (DSC) to enrich sound.







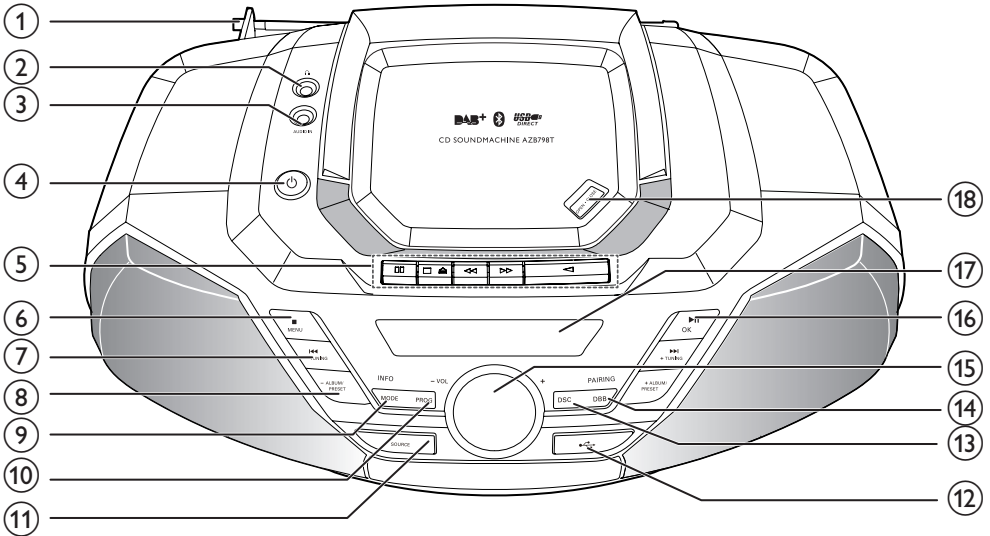

What's in the box

Check and identify the contents of the package:

- Main unit
- AC power cord
- Remote control (with battery)
- Short user manual
- Safety sheet

Overview of the main unit



- ① **FM antenna**
 - Improve FM reception.
- ② 
 - Headphone socket.
- ③ **AUDIO-IN**
 - Connect an external audio device.
- ④ 
 - Turn the unit on or off.
- ⑤ **Tape controls**
 -  Start tape play.
 -  Fast rewind or fast forward the tape. Stop tape play or open the tape door.
 -  Pause tape play.
- ⑥  / **MENU**
 - Stop play.
 - Erase a program.
 - Enter DAB+/FM menu.
- ⑦  **TUNING +/-**
 - Skip to the previous or next track.
- ⑧ **ALBUM/PRESET +/-**
 - Select a preset radio station.
 - Skip to the previous or next album.
- ⑨ **MODE/INFO**
 - Select a play mode: repeat or shuffle.
 - Display the play information.
- ⑩ **PROG**
 - Program tracks.
- ⑪ **SOURCE**
 - Select a source.
- ⑫ 
 - USB socket.
- ⑬ **DSC**
 - Select a preset sound setting.
- ⑭ **DBB/PAIRING**
 - Turn dynamic bass boost on or off.
 - In Bluetooth mode, press and hold to enter pairing mode.
- ⑮ **VOL +/-**
 - Adjust volume.

- 16 **▶||/OK**
 - Press to start or pause the play.
 - Confirm the selection.
- 17 **Display panel**
 - Display current status.
- 18 **OPEN•CLOSE**
 - Open the disc compartment.

Overview of the remote control

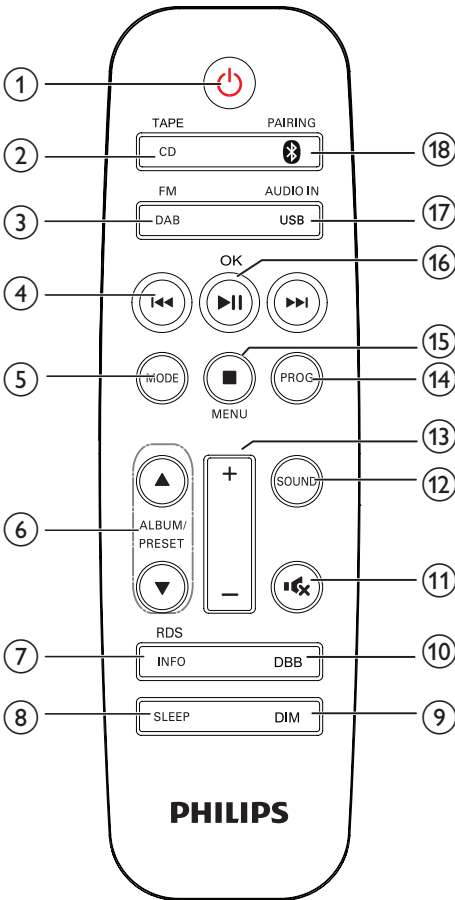

- 1 **⏻**
 - Turn the unit on or off.
- 2 **CD/TAPE**
 - Select the DISC source.
 - Select the tape source.
- 3 **FM/DAB**
 - Select the FM source.
 - Select the DAB source.
- 4 **◀◀ / ▶▶**
 - Skip to the previous/next track.
 - Search within a track/disc/USB.
 - Tune to a radio station.
 - Adjust time.
- 5 **MODE**
 - Select the play mode.
- 6 **ALBUM/PRESET ▲ / ▼**
 - Select a preset radio station.
 - Skip to the previous/next album.
- 7 **INFO/RDS**
 - During playback, display the play information.
 - For selected FM radio stations, display RDS information(if available).
- 8 **SLEEP**
 - Set sleep timer.
- 9 **DIM**
 - Adjust the display brightness.
- 10 **DBB**
 - Turn dynamic bass enhancement on/off.
- 11 **🔇**
 - Mute or restore volume.
- 12 **SOUND**
 - Enrich sound effect with Digital Sound Control (DSC).
- 13 **+/-**
 - Adjust volume.
- 14 **PROG**
 - Program tracks.
 - Program FM/DAB+ radio stations.

⑮ ■ /MENU

- Stop play or erase a program.
- Access FM/DAB+ menu.

⑯ ▶||/OK

- Start, pause, or resume play.
- Confirm the selection.

⑰ USB/AUDIO IN

- Press repeatedly to select the USB or AUDIO IN source.

⑱ ⓘ /PAIRING

- Press to select the BT (Bluetooth) source.
- Press and hold for 2 seconds to enter pairing mode

3 Get started

! **Caution**

- Use of controls or adjustments or performance of procedures other than herein may result in hazardous laser exposure or other unsafe operation.

Always follow the instructions in this chapter in sequence.

If you contact Philips, you will be asked for the model and serial number of your apparatus. The model number and serial number are on the bottom of your apparatus. Write the numbers here:

Model No. _____

Serial No. _____

Prepare the remote control

! **Caution**

- Risk of product damage! When the remote control is not used for long periods, remove the batteries.

To insert the remote control battery:

- 1 Open the battery compartment.
- 2 Insert the supplied AAA battery with correct polarity (+/-) as indicated.
- 3 Close the battery compartment.

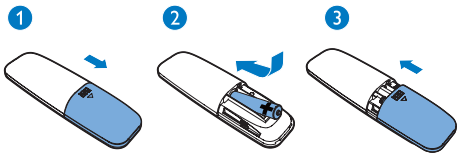

Connect power

The unit can be powered by either AC power or batteries.

Option 1: AC power

! **Warning**

- Risk of product damage! Make sure that the power supply voltage corresponds to the voltage printed on the back or the underside of the unit.
- Risk of electric shock! When you disconnect the AC power, always pull the plug from the socket. Never pull the cord.

Connect the AC power cord to:

- the **AC~ MAINS** socket on the unit.
- the wall socket.

***** **Tip**

- To save energy, turn the unit off after use.

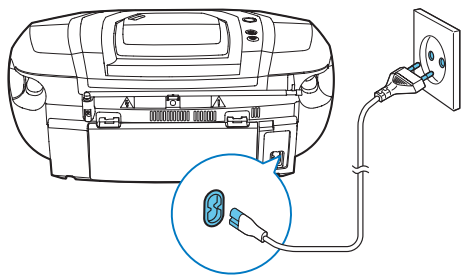

Option 2: Battery power

! **Caution**

- Batteries contain chemical substances, so they should be disposed of properly.

≡ **Note**

- Batteries are not supplied with the accessories.

- 1 Open the battery compartment.
- 2 Insert 6 batteries (type: R-20 or D CELL) with correct polarity (+/-) as indicated.
- 3 Close the battery compartment.

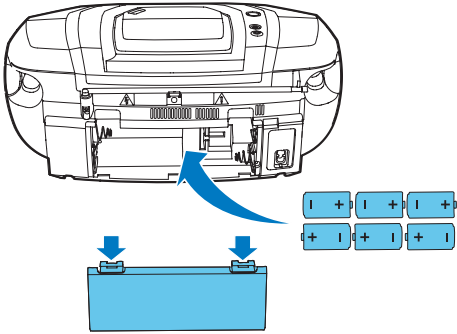

Turn on

Press \odot .

- ↳ The unit switches to the last selected source.



Tip

- To select a source, press **SOURCE** repeatedly or the source selection buttons on the remote control.

Turn off

Press \odot again.

- ↳ The backlight on the display panel turns off.

4 Play

Play CD

- 1 Press **CD** to select the disc source.
- 2 Press **OPEN•CLOSE** to open the disc tray.
- 3 Insert a disc with the printed side facing up, then close the disc tray.
↳ Play starts automatically.

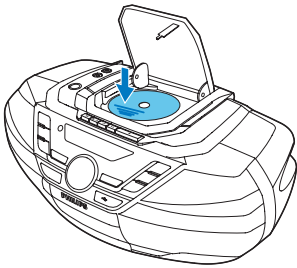

Play from USB devices

Note

- Make sure that the USB device contains playable audio content.

- 1 Press **USB** to select USB source.
- 2 Insert the USB device into the  socket.
↳ Play starts automatically. If not, press **▶||**.

Note

- The maximum current for USB is 0.5A.

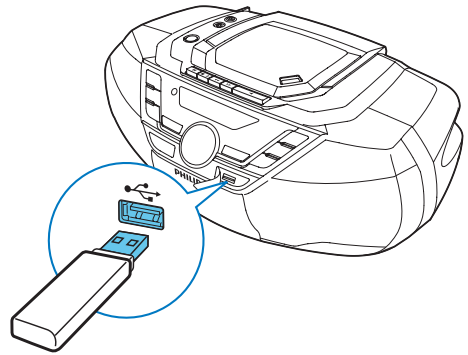

Play from Bluetooth-enabled devices

With this product, you can listen to audio from Bluetooth-enabled devices.

Note

- WOOX Innovations does not guarantee the compatibility with all Bluetooth devices.
- Before pairing a device with this product, read its user manual for Bluetooth compatibility. Make sure that the connected Bluetooth device supports the Advanced Audio Distribution Profile (A2DP) and the Audio Video Remote Control Profile (AVRCP).
- The product can connect a maximum of 8 Bluetooth devices simultaneously.
- Make sure that Bluetooth function is enabled on your device, and your device is set as visible to all other Bluetooth devices.
- The operational range between this product and a Bluetooth device is approximately 10 meters (33 feet).
- Any obstacle between this product and a Bluetooth device can reduce the operational range.
- Keep away from any other electronic device that may cause interference.

- 1 Press **BT** to select Bluetooth source.
↳ **[BLUETOOTH]**(Bluetooth) is displayed.
↳ The CD sound machine enters pairing mode, and **[PAIRING]** (Pairing) is displayed on the screen.

2 On your Bluetooth device, enable Bluetooth and search for Bluetooth devices (refer to the user manual of the device).

3 Select **[Philips AZB798T]** on your device for pairing. If necessary, enter default password "0000".

↳ After successful pairing and connection, the product beeps twice, and **[CONNECTED]** (connected) is displayed on the screen.

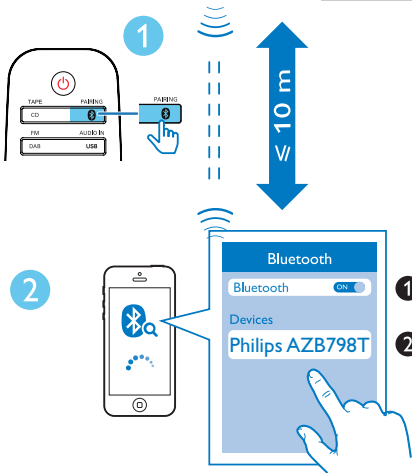
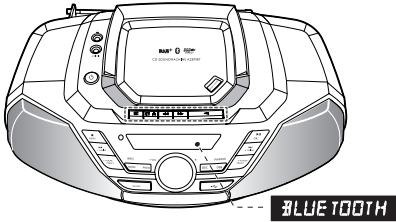

4 After successful Bluetooth connection, play audio on the Bluetooth device.

↳ Audio streams from your Bluetooth device to the product.

- To skip to previous/next track, press **▶|/▶|**.
- To pause or resume the playback, press **▶||**.

Note

- If you cannot find **[Philips AZB798]** on your device, press **DBB/PAIRING** on the main unit or **0** // **PAIRING** on remote control for 2 seconds to enter pairing mode. **[PAIRING]** (Pairing) is display on the screen.

Disconnect the Bluetooth-enabled device

- Press and hold **PAIRING** for 2 seconds;
- Disable Bluetooth on your device; or
- Move the device beyond the communication range.

Connect another Bluetooth-enabled device

Disable Bluetooth on the current device, and then connect another device.

Clear Bluetooth pairing history

Press and hold **■** for 7 seconds to clear the Bluetooth pairing history.

Play tape

Note

- The CD sound machine will turn off automatically after an elapsed time of inactivity at tape mode.

1 Press **CD/TAPE** repeatedly to select **TAPE** source.

2 Press **■** / **▲** on the CD sound machine to open the tape door.

3 Load the tape with the open side upward and the full spool to the right.

4 Press **◀** on the CD sound machine to start play.

- To pause/resume play, press **||** on main unit .

- To rewind or fast-forward, press ◀◀/▶▶ on CD sound machine .
- To stop play, press ■▲.
- ↳ The CD sound machine turns off automatically.

Note

- In playback mode, cassette will be stopped automatically when playback reaches the end.
- There is no display on the LCD screen in tape mode.

Play from an external device

You can also listen to an external audio device such as an MP3 player through this product.



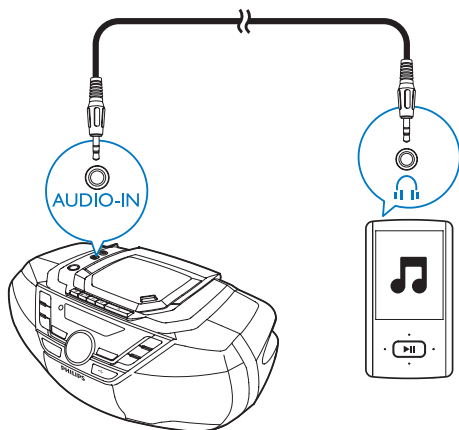





- 1 Press **TUNER/AUDIO IN** repeatedly to select **[AUDIO-IN]** source.
- 2 Connect an audio cable (3.5mm, not supplied) to:
 - the **AUDIO-IN** socket on the unit.
 - the headphone socket on an external device.
- 3 Play the external device (see the device's user manual).





5 Play options

Control play

In CD or USB mode, you can control play through the following operations.



| | |
|--|---|
|  | Press and hold to fast-forward or fast-reverse the track during playback, then release to resume play. |
|  | Skip to the previous or next MP3 album. |
|  | Skip to the previous or next track. |
|  | Start or pause play. |
|  | Stop play. |
| MODE | []: Play the current track repeatedly. []: Play all tracks repeatedly. []: Play tracks randomly. |



Tip

- Only [] and [] can be selected when you play the programmed tracks.

Program tracks

In CD or USB mode, you can program a maximum of 20 tracks.

- 1 Press  to stop playback.
- 2 Press **PROG** to activate the program mode.
↳ **[PROG]** (program) begin to blink.
- 3 For MP3 tracks, press **ALBUM/PRESET +/-** to select an album.
- 4 Press  to select a track number; then press **PROG** to confirm.
- 5 Repeat steps 3-4 to program more tracks.

- 6 Press  to play the programmed tracks.
↳ During play, **[PROG]** (program) is displayed.
 - To erase the program, press  twice.
 - To review the program, when playback is stopped, press and hold **PROG** for 2 seconds.

Adjust sound

During play, you can adjust volume and select the sound effects.

| Key | Function |
|---|---|
| VOL +/- | Increase or decrease volume. |
|  | Mute or resume sound. |
| DBB | Turn dynamic bass enhancement on or off. |
| SOUND | Select a preset sound effect: POWERFUL (powerful); BALANCE (balance); WARM (warm); BRIGHT (bright), and CLEAR (clear), |

6 Listen to FM radio

Tune to FM radio stations

Note

- For optimal reception, fully extend and adjust the position of the FM antenna.

1 Press **FM/DAB** repeatedly to select FM radio source.

2 Press and hold **◀▶** for 2 seconds.
↳ **[SEARCH]** (search) is displayed.
↳ The product tunes to a station with strong reception automatically.

3 Repeat step 2 to tune to more stations.

To tune to a radio station with weak signal:

Press **◀▶** repeatedly until you find better reception.

Store radio stations manually

Note

- You can program a maximum of 20 FM radio stations.

- 1 Tune to an FM radio station.
- 2 Press **PROG** to activate the storing mode.
- 3 Press **▲▼** to allocate a number (1 to 20) to this radio station, then press **PROG** to confirm.
↳ The preset number and the frequency of the preset station are displayed.
- 4 Repeat the above steps to store other stations.

Note

- To remove a pre-stored FM radio station, store another station in its place.

Store radio stations automatically

Note

- You can program a maximum of 20 FM radio stations.

In tuner mode, press and hold **PROG** for 2 seconds.

- ↳ **[AUTO STORE]** (auto store) is displayed.
- ↳ The unit stores all the available FM radio stations.
- ↳ The first stored radio station is broadcast automatically.

Select a preset radio station

In FM tuner mode, press **▲▼** to select a preset number.

7 Listen to DAB radio stations

Listen to DAB radio stations

Note

- For optimal reception, fully extend the antenna and adjust its position.
- You can program a maximum of 20 DAB radio stations.
- Check with local retailer or go to www.WorldDAB.org for applicable DAB radio frequencies in your area.

For the first time use

- 1 Press **FM/DAB** to select the **DAB** source.
↳ **[Full scan]** menu is displayed.
- 2 Press **OK** to activate the automatic search.
↳ This product automatically stores radio stations with sufficient signal strength.
↳ After the search is complete, the first stored radio station is broadcast automatically.
- 3 Press **▲ / ▼** to select a station, and then start listening.

Program radio stations

- 1 Tune to a DAB radio station.
- 2 Press **PROG** to activate the programming.
- 3 Press **▲ ▼** to select a preset sequence number.
- 4 Press **PROG** to confirm.
↳ The radio station is stored with the selected sequence number.

- 5 Repeat steps 1-4 to program more radio stations.

Note

- If you store a radio station with the sequence number of another one, the earlier one is overwritten.

Display DAB information

On the display of DAB broadcasting, the first line shows station name, and the second line shows the service information for the current station.

Press **INFO/RDS (INFO/MODE)** repeatedly to cycle through the following information (if available).

- Dynamic label segment (DLS)
- Signal strength
- Program type (PTY)
- Ensemble name
- Frequency
- Signal error rate
- Bitrate codec
- Time
- Date

Use DAB menus

- 1 In DAB mode, press **MENU** to access the DAB menus.
- 2 Press **◀◀ / ▶▶** to toggle through the menus.
 - **[FULL SCAN]**: Scan for the DAB stations.
 - **[MANUAL]**: Tune to a station manually.
 - **[PRUNE]**: Remove invalid stations
 - **[SYSTEM]**: Access system setting menu.
- 3 Press **OK** to enter the menu.

Re-scan for stations

Full scan is used to perform a wide range search for DAB radio stations.

- Press **OK** to activate the automatic search.
 - ↳ This product automatically stores radio stations with sufficient signal strength.

Tune to a station manually

With this feature, you can tune to a specific channel/frequency manually. In addition to antenna orientation for better radio reception, the optimal reception can also be obtained with this feature.

- 1 Press **OK** to access the station list.
- 2 Press **◀◀ / ▶▶** to select a station.
- 3 Press **OK** to confirm the option.

Remove invalid stations

This option lists active stations and removes any stations that are in the list but have no service in your area.

- 1 Press **OK** to access the **[PRUNE]** menu.
- 2 Press **◀◀ / ▶▶** to select an option.
 - **[N]**: Return to the previous menu.
 - **[Y]**: Remove invalid stations from the station list.
- 3 Press **OK** to confirm the selection.

System menus

- 1 Press **OK** to access system menu.
- 2 Press **◀◀ / ▶▶** to to select a sub-menu.
 - For details, refer to the section '**Use system menus**'.

8 Use system menus

With the system menus, you can:

- **[RESET]**: Reset the product to factory default status.
- **[UPGRADE]**: Upgrade the software.
- **[SWVER]**: Check the version of current software of this product.

Reset the product

- 1 Press **OK** to display the options.
- 2 Press **◀◀**/**▶▶** to select an option.
 - **[N]**: Return to the previous menu.
 - **[Y]**: Reset the product to factory default status.
- 3 Press **OK** to confirm the option.

Check the current software version

Press **OK** to display the version of current software.

9 Other features

Set the sleep timer

This unit can switch to standby automatically after a preset period.

When the unit is turned on, press **SLEEP** repeatedly to select the sleep timer period (in minutes).

↳ When the sleep timer is activated, **z²** appears.

To deactivate sleep timer:

- Press **SLEEP** repeatedly until **[SLEEP OFF]** (sleep off) is displayed.

↳ When sleep timer is deactivated, **z²** disappears.

Adjust the display brightness

Press **DIM** repeatedly to select different brightness levels.

Listen through the headphone

Plug a headphone into the  socket on the unit.

10 Product information



Note

- Product information is subject to change without prior notice.

Specifications

Amplifier

| | |
|---------------------------|----------------------|
| Max Output Power | Total 12 W |
| Frequency Response | 63 -20 KHz, +/-3dB |
| Signal to Noise Ratio | >72 dBA |
| Total Harmonic Distortion | <1 % |
| Audio-in Input | 650 mV RMS 22kohm |

Disc

| | |
|---------------------------|----------------------------|
| Laser Type | Semiconductor |
| Disc Diameter | 12cm/8cm |
| Support Disc | CD-DA, CD-R, CD-RW, MP3-CD |
| Audio DAC | 24Bits / 44.1kHz |
| Total Harmonic Distortion | <1% |
| Frequency Response | 63 -20 KHz, +/-3dB |
| S/N Ratio | >72 dBA |

Tuner

| | |
|-----------------|--|
| Tuning Range | FM: 87.5 - 108MHz DAB: 174.928 - 239.200 MHz |
| Tuning grid | 50 kHz |
| Preset stations | 20 |

| | |
|---------------------------|---------|
| Sensitivity: | |
| -Mono, 26dB S/N Ratio | <22 dBf |
| -Stereo, 46dB S/N Ratio | <43 dBf |
| Search Selectivity | <28dBf |
| Total Harmonic Distortion | <2% |
| Signal to Noise Ratio | >55 dB |

Tape deck

| | |
|------------------------|---------------|
| Frequency response | 125 - 8000 Hz |
| - Normal tape (type I) | (8 dB) |
| Signal-to-noise ratio | |
| - Normal tape (type I) | 35 dBA |
| Wow and flutter | ≤ 0.4% DIN |

Bluetooth

| | |
|-------------------|--------------------------------|
| Bluetooth Version | V3.0 + EDR |
| Range | 10 m (Free space) |
| Frequency band/ | 2.400GHz - 2.483GHz |
| Output power | ISM Band / ≤ 4dBm (Class 2) |

General

| | |
|-----------------------------|----------------------------------|
| Power supply | |
| - AC Power | 220-240V~, 50/60 Hz; |
| - Battery | DC 9V, 6 × 1.5V/ R-20 /D CELL |
| Operation Power Consumption | 15 W |
| Standby Power Consumption | < 0.5 W |
| Dimensions | |
| - Main Unit (W × H × D) | 435 × 170 × 271 mm |
| Weight (Main Unit) | 2.96 kg |

Supported MP3 disc formats

- ISO9660, Joliet
- Maximum title number: 512 (depending on file name length)
- Maximum album number: 255
- Supported sampling frequencies: 32 kHz, 44.1kHz, 48 kHz
- Supported Bit-rates: 32~256 (kbps), variable bit rates

USB playability information

Compatible USB devices:

- USB flash memory (USB 2.0 or USB1.1)
- USB flash players (USB 2.0 or USB1.1)
- memory cards (requires an additional card reader to work with this apparatus)

Supported formats:

- USB or memory file format FAT12, FAT16, FAT32 (sector size: 512 bytes)
- MP3 bit rate (data rate): 32-320 Kbps and variable bit rate
- Directory nesting up to a maximum of 8 levels
- Number of albums/ folders: maximum 99
- Number of tracks/titles: maximum 999
- ID3 tag v2.0 or later
- File name in Unicode UTF8 (maximum length: 128 bytes)

Unsupported formats:

- Empty albums: an empty album is an album that does not contain MP3/WMA files, and is not be shown in the display.
- Unsupported file formats are skipped. For example, Word documents (.doc) or MP3 files with extension .dlf are ignored and not played.
- WMA, AAC, WAV, PCM audio files
- DRM protected WMA files (.wav, .m4a, .m4p, .mp4, .aac)
- WMA files in Lossless format

Maintenance

Clean the cabinet

- Use a soft cloth slightly moistened with a mild detergent solution. Do not use a solution containing alcohol, spirits, ammonia or abrasives.

Clean discs

- When a disc becomes dirty, clean it with a cleaning cloth. Wipe the disc from the centre out.



- Do not use solvents such as benzene, thinner, commercially available cleaners, or antistatic spray intended for analogue records.

Clean the disc lens

- After prolonged use, dirt or dust may accumulate at the disc lens. To ensure good play quality, clean the disc lens with Philips CD lens cleaner or any commercially available cleaner. Follow the instructions supplied with cleaner.

Clean the heads and the tape paths

- To ensure good recording and play quality, clean the heads **A**, the capstan(s) **B**, and pressure roller(s) **C** after every 50 hours of tape operation.
- Use a cotton swab slightly moistened with cleaning fluid or alcohol.

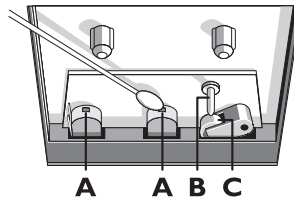

- You can also clean the heads by playing a cleaning tape once.

Demagnetise the heads

- Use a demagnetising tape available at your dealer:

11 Troubleshooting



Warning

- Never remove the casing of this device.

To keep the warranty valid, never try to repair the system yourself.

If you encounter problems when using this device, check the following points before requesting service. If the problem remains unsolved, go to the Philips Web page (www.philips.com/support). When you contact Philips, make sure that the device is nearby and the model number and serial number are available.

No power

- Ensure that the AC power plug of the unit is connected properly.
- Ensure that there is power at the AC outlet.
- Insert the batteries with their polarities (+/- signs) aligned as indicated.
- Replace the battery.

No sound or poor sound

- Adjust the volume.

No response from the unit

- Disconnect and reconnect the AC power plug, then turn on the system again.
- As a power-saving feature, the unit switches off automatically 15 minutes after track play reaches the end and no control is operated.

Remote control does not work

- Before you press any function button, first select the correct source with the remote control instead of the main unit.
- Reduce the distance between the remote control and the unit.
- Insert the battery with its polarities (+/- signs) aligned as indicated.
- Replace the battery.
- Aim the remote control directly at the sensor on the front of the unit.

USB device not supported

- The USB device is incompatible with the apparatus. Try another one.

No disc detected

- Insert a disc.
- Check if the disc is inserted upside down.
- Wait until the moisture condensation at the lens has cleared.
- Replace or clean the disc.
- Use a finalized CD or correct format disc.

Poor radio reception

- Increase the distance between the unit and your TV or VCR.
- Fully extend the FM antenna.

Music playback is unavailable on this unit even after successful Bluetooth connection.

- The device cannot be used to play music through this unit wirelessly.

The audio quality is poor after connection with a Bluetooth-enabled device.

- The Bluetooth reception is poor: Move the device closer to this unit or remove any obstacle between them.

Bluetooth cannot be connected with this unit.

- The device does not support the profiles required for this unit.
- The Bluetooth function of the device is not enabled. Refer to the user manual of the device to find out how to enable the function.
- This unit is not in pairing mode.
- This unit is already connected with another Bluetooth-enabled device. Disconnect that device and then try again.

The paired mobile device connects and disconnects constantly.

- The Bluetooth reception is poor: Move the device closer to this unit or remove any obstacle between them.
- Some mobile phones may connect and disconnect constantly when you make or end calls. This does not indicate any malfunction of this unit.
- For some devices, the Bluetooth connection may be deactivated automatically as a power-saving feature. This does not indicate any malfunction of this unit.

12 Notice

Any changes or modifications made to this device that are not expressly approved by Gibson Innovations may void the user's authority to operate the equipment.

Compliance

Declaration of conformity

Hereby, Gibson Innovations declares that this product is in compliance with the essential requirements and other relevant provisions of Directive 2014/53/EU. You can find the Declaration of Conformity on www.philips.com/support.

Care of the environment

Disposal of your old product and battery



Your product is designed and manufactured with high quality materials and components, which can be recycled and reused.



This symbol on a product means that the product is covered by European Directive 2012/19/EU.



This symbol means that the product contains batteries covered by European Directive 2013/56/EU which cannot be disposed of with normal household waste.

Inform yourself about the local separate collection system for electrical and electronic products and batteries. Follow local rules and never dispose of the product and batteries with normal household waste. Correct disposal of old products and batteries helps prevent negative consequences for the environment and human health.

Removing the disposable batteries

To remove the disposable batteries, see battery installation section.

Environmental information

All unnecessary packaging has been omitted. We have tried to make the packaging easy to separate into three materials: cardboard (box), polystyrene foam (buffer) and polyethylene (bags, protective foam sheet.)

Your system consists of materials which can be recycled and reused if disassembled by a specialized company. Please observe the local regulations regarding the disposal of packaging materials, exhausted batteries and old equipment.

Trademark notice



**Be responsible
Respect copyrights**

The making of unauthorized copies of copy-protected material, including computer programs, files, broadcasts and sound recordings, may be an infringement of copyrights and constitute a criminal offence. This equipment should not be used for such purposes.



The Bluetooth® word mark and logos are registered trademarks owned by Bluetooth SIG, Inc. and any use of such marks by Gibson Innovations Limited is under license. Other

trademarks and trade names are those of their respective owners.

This apparatus includes these labels:



Class II equipment symbol



This symbol indicates that the apparatus has a double insulation system.



The USB-IF Logos are trademarks of Universal Serial Bus Implementers Forum, Inc.



Note

- The type plate is located on the bottom of the apparatus.



Copyright ©2015 Gibson Innovations Limited. Revised Edition ©2017

This product has been manufactured by, and is sold under the responsibility of Gibson Innovations Ltd., and Gibson Innovations Ltd. is the warrantor in relation to this product.

Philips and the Philips Shield Emblem are registered trademarks of Koninklijke Philips N.V. and are used under license.

AZB798T_12_UM_V3.0

