

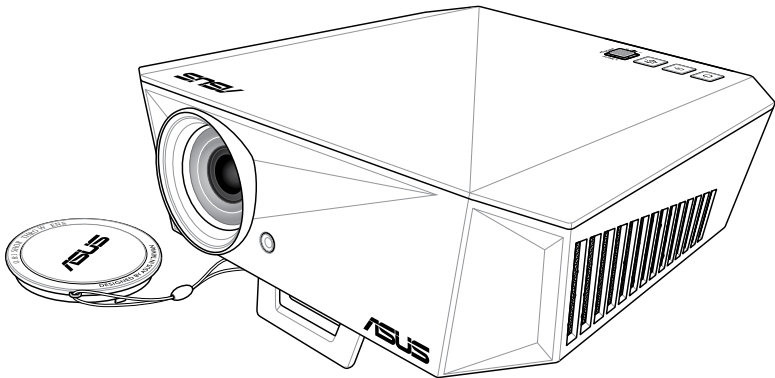

LED projector

E-Manual

F1 Series



E14384

First Edition

March 2019

COPYRIGHT AND WARRANTY INFORMATION

No part of this manual, including the products and software described in it, may be reproduced, transmitted, transcribed, stored in a retrieval system, or translated into any language in any form or by any means, except documentation kept by the purchaser for backup purposes, without the express written permission of ASUSTeK COMPUTER INC. ("ASUS").

Product warranty or service will not be extended if: (1) the product is repaired, modified or altered, unless such repair, modification of alteration is authorized in writing by ASUS; or (2) the serial number of the is defaced or missing.

ASUS PROVIDES THIS MANUAL "AS IS" WITHOUT WARRANTY OF ANY KIND, EITHER EXPRESS OR IMPLIED, INCLUDING BUT NOT LIMITED TO THE IMPLIED WARRANTIES OR CONDITIONS OF MERCHANTABILITY OR FITNESS FOR A PARTICULAR PURPOSE. IN NO EVENT SHALL ASUS, ITS DIRECTORS, OFFICERS, EMPLOYEES OR AGENTS BE LIABLE FOR ANY INDIRECT, SPECIAL, INCIDENTAL, OR CONSEQUENTIAL DAMAGES (INCLUDING DAMAGES FOR LOSS OF PROFITS, LOSS OF BUSINESS, LOSS OF USE OR DATA, INTERRUPTION OF BUSINESS AND THE LIKE), EVEN IF ASUS HAS BEEN ADVISED OF THE POSSIBILITY OF SUCH DAMAGES ARISING FROM ANY DEFECT OR ERROR IN THIS MANUAL OR PRODUCT.

Products and corporate names appearing in this manual may or may not be registered trademarks or copyrights of their respective companies, and are used only for identification or explanation and to the owners' benefit, without intent to infringe.

SPECIFICATIONS AND INFORMATION CONTAINED IN THIS MANUAL ARE FURNISHED FOR INFORMATIONAL USE ONLY, AND ARE SUBJECT TO CHANGE AT ANY TIME WITHOUT NOTICE, AND SHOULD NOT BE CONSTRUED AS A COMMITMENT BY ASUS. ASUS ASSUMES NO RESPONSIBILITY OR LIABILITY FOR ANY ERRORS OR INACCURACIES THAT MAY APPEAR IN THIS MANUAL, INCLUDING THE PRODUCTS AND SOFTWARE DESCRIBED IN IT.

Copyright © 2019 ASUSTeK COMPUTER INC. All Rights Reserved.

LIMITATION OF LIABILITY

Circumstances may arise where because of a default on ASUS' part or other liability, you are entitled to recover damages from ASUS. In each such instance, regardless of the basis on which you are entitled to claim damages from ASUS, ASUS is liable for no more than damages for bodily injury (including death) and damage to real property and tangible personal property; or any other actual and direct damages resulted from omission or failure of performing legal duties under this Warranty Statement, up to the listed contract price of each product.

ASUS will only be responsible for or indemnify you for loss, damages or claims based in contract, tort or infringement under this Warranty Statement.

This limit also applies to ASUS' suppliers and its reseller. It is the maximum for which ASUS, its suppliers, and your reseller are collectively responsible.

UNDER NO CIRCUMSTANCES IS ASUS LIABLE FOR ANY OF THE FOLLOWING: (1) THIRD-PARTY CLAIMS AGAINST YOU FOR DAMAGES; (2) LOSS OF, OR DAMAGE TO, YOUR RECORDS OR DATA; OR (3) SPECIAL, INCIDENTAL, OR INDIRECT DAMAGES OR FOR ANY ECONOMIC CONSEQUENTIAL DAMAGES (INCLUDING LOST PROFITS OR SAVINGS), EVEN IF ASUS, ITS SUPPLIERS OR YOUR RESELLER IS INFORMED OF THEIR POSSIBILITY.

SERVICE AND SUPPORT

Visit our multi-language web site at <https://www.asus.com/support>

Table of Contents

About this manual	5
Conventions used in this manual	6
Typography	6
Multi-language versions	6
Safety precautions	7
Using your LED projector	7
Servicing and replacement of parts	7
Caring for your LED projector	8
Proper disposal	8

Chapter 1: Knowing your LED projector

Features	10
Top view	10
Front view	12
Rear view	13
Left side	14
Right side	15
Bottom view	16
Mounting your LED projector	17
Projecting files from a mounted position	18
Ceiling mount hole details	18
LED projector remote control	19
Replacing the battery	21
Remote control effective range	23

Chapter 2: Setting up

Operating your LED projector	26
Connect the LED projector to the power adapter	26
Connect the LED projector to your device	28
Adjust the height of the LED projector	32
Press the power button	34
Adjust the image focus	35

Chapter 3: Using the onscreen display menu

Using your LED projector for the first time	38
Adjusting your LED projector's settings	39
Onscreen display menu options.....	40
Image	40
Display	41
Input	42
System	43
Turning off your LED projector.....	45
Using 3D glasses.....	46
Multi-language versions	47

Appendices

Federal Communications Commission Statement.....	50
Regional notice for California.....	51
Global Environmental Regulation Compliance and Declaration ..	52
ASUS Recycling/Takeback Services.....	52
Specifications for F1 series LED projector.....	53
Supported PC Timings	56

About this manual

This manual provides information about the hardware and software features of your LED projector through the following chapters:

Chapter 1: Knowing your LED Projector

This chapter details the parts of your LED projector and its accompanying remote control.

Chapter 2: Setting up

This chapter shows you how to set up your LED projector and use its parts for input device connection.

Chapter 3: Using the onscreen display menu

This chapter talks about the features of your LED projector's onscreen display menu and how to navigate it using the control panel.

Appendices

This section includes safety notices for your LED projector.

Conventions used in this manual

To highlight key information in this manual, some text are presented as follows:

IMPORTANT! This message contains vital information that must be followed to complete a task.

NOTE: This message contains additional information and tips that can help complete tasks.

WARNING! This message contains important information that must be followed to keep you safe while performing tasks and prevent damage to your LED projector's data and components.

Typography

Bold = This indicates a menu or an item that must be selected.

Italic = This indicates sections that you can refer to in this manual.

Multi-language versions

Download other language versions of this E-Manual via this website:

<https://www.asus.com/support>

Safety precautions

Using your LED projector

- Refer to the manual and take note of the safety instructions before operating your LED projector.
- Follow the notes and warnings stated in the user manual.
- Do not place your LED projector on uneven or unstable surfaces.
- Do not use your LED projector in smoky environments. Smoke residue may cause build-up on critical parts and damage the LED projector or decrease its performance.
- Keep the LED projector's plastic packages out of the reach of children.
- Do not block or place anything near the LED projector's ventilation holes. Doing so may cause internal heat build-up that can degrade picture quality and damage the projector.
- Ensure that the operating voltage of your LED projector matches the voltage of your power source.

Servicing and replacement of parts

- Do not disassemble or attempt to service this LED projector by yourself. Contact your local ASUS service center for assistance.
- When replacing parts of your LED projector, purchase items as specified by ASUS and contact your local service center for assistance.

Caring for your LED projector

- Switch off then unplug the LED projector from the power outlet before cleaning it.
- When cleaning the LED projector's housing, use a clean soft cloth dampened with water or a mix of water and neutral detergent. Wipe it dry using a soft dry cloth.
- Ensure that the lens is cool before cleaning it. Gently wipe the lens using a lens cleaning paper. Do not touch the lens with your hands.
- Do not use liquid or aerosol cleaners, benzene, or thinners on your LED projector.
- Never operate this LED projector immediately after moving it from a cold location. When the LED projector is exposed to a drastic change in temperature, moisture may condense on the lens and its other internal parts. To prevent this, use the unit two (2) hours after an extreme or sudden change in temperature occurs.

Proper disposal



Do not throw your LED projector in municipal waste. This product has been designed to enable proper reuse of parts and recycling. The symbol of the crossed out wheeled bin indicates that the product (electrical, electronic equipment and mercury-containing button cell battery) should not be placed in municipal waste. Check local regulations for disposal of electronic products.



Do not throw the battery in municipal waste. The symbol of the crossed out wheeled bin indicates that the battery should not be placed in municipal waste.

Chapter 1:
***Knowing your LED
projector***

Features

Top view

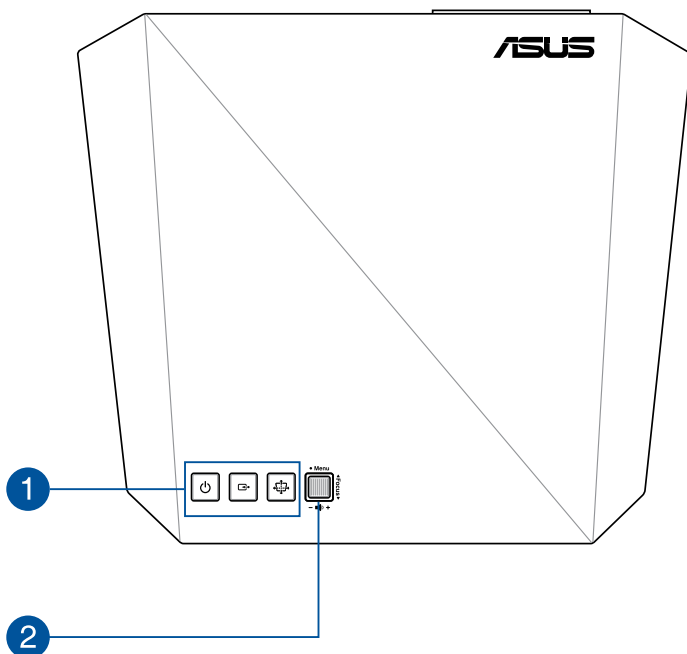

1 Control panel buttons

These buttons correspond to a specific LED projector setting as indicated below.



Keystone



Input



Power

NOTE: In the event that your LED projector becomes unresponsive, unplug the power cord and wait until your LED projector shuts down.

2 Joystick

This joystick allows you to navigate the onscreen display menu and select menu settings. This joystick also correspond to specific LED projector settings as indicated below.



Open main menu / OK
(push center)



Adjust focus
(move up or down)



Adjust volume
(move left or right)

NOTE: For more information on using your LED projector's settings, refer to the *Using the onscreen display menu* section in this manual.

Front view

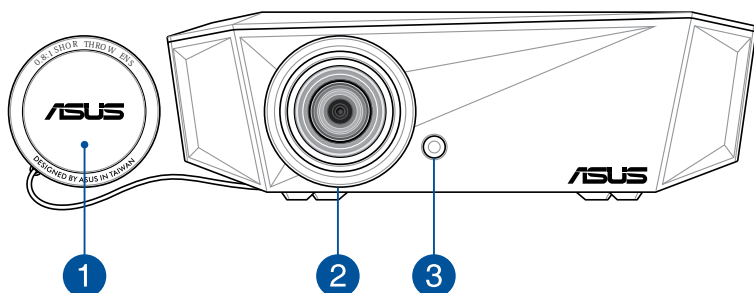

1 Lens cover

The lens cover protects the lens from scratches and possible dirt build-up.

IMPORTANT! Remove the lens cover before using your LED projector.

2 Lens

The lens projects video or image files onscreen from your input device.

WARNING! Do not touch the lens using your hands or any sharp object.

3 Auto focus camera

This camera helps the LED projector with the auto focus feature.

Rear view

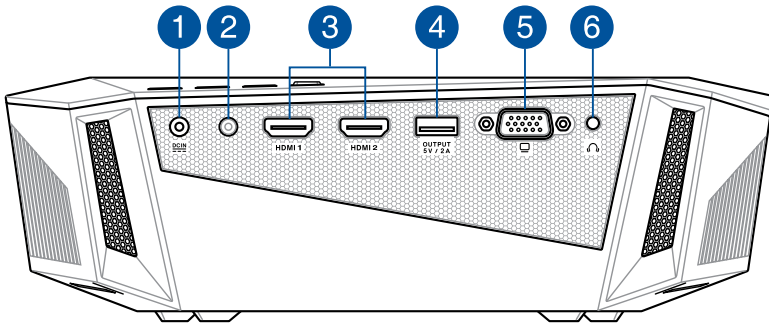

1 Power (DC) input port

Insert the bundled power adapter into this port to supply power to your LED projector.

WARNING! The adapter may become warm to hot while in use. Do not cover the adapter and keep it away from your body while it is connected to a power source.

IMPORTANT! Use only the bundled power adapter to supply power to your LED projector.

2 Remote sensor

The remote sensor detects signal from your LED projector's remote control, allowing you to access the LED projector's control panel from a distance of up to 8 meters and a receiving angle of ± 30 degrees.

3 HDMI ports

These ports are for the HDMI (High-Definition Multimedia Interface) connectors. These port are HDCP compliant for HD DVD, Blu-ray, and other protected content playback.

4 Power output port

This power output port provides up to 5V/2A of output voltage and current. You can connect your mobile device to this port to keep it charged.

5 VGA port

This port allows you to connect your LED projector to other VGA-compatible devices.

6 Audio output jack port

The audio output jack port allows you to connect your LED projector to amplified speakers or headphones.

Left side

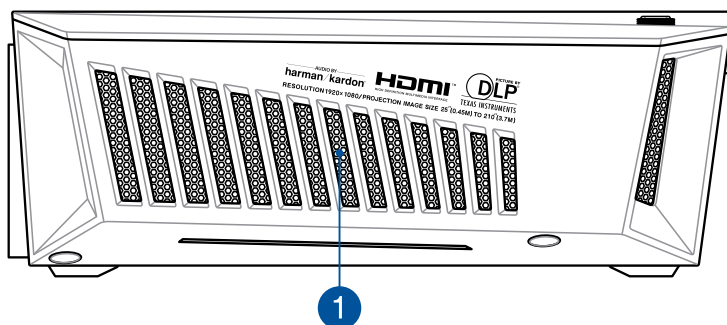

1 Air vents

The air vents allow cool air to enter and warm air to exit your LED projector.

WARNING! Ensure that paper, books, clothing, cables, or other objects do not block any of the air vents or else overheating may occur.

Right side

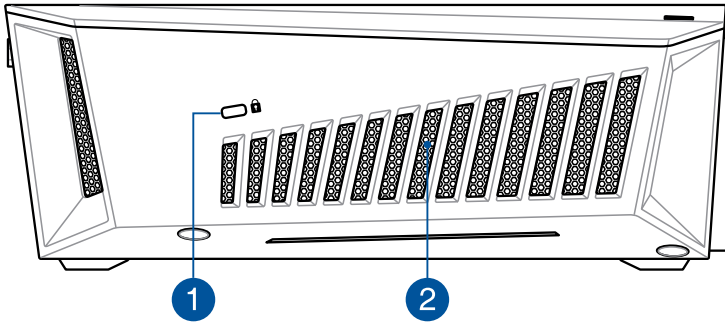

1 Kensington® security slot

The Kensington® security slot allows you to secure your LED projector using Kensington® compatible LED projector security products.

2 Air vents

The air vents allow cool air to enter and warm air to exit your LED projector.

WARNING! Ensure that paper, books, clothing, cables, or other objects do not block any of the air vents or else overheating may occur.

Bottom view

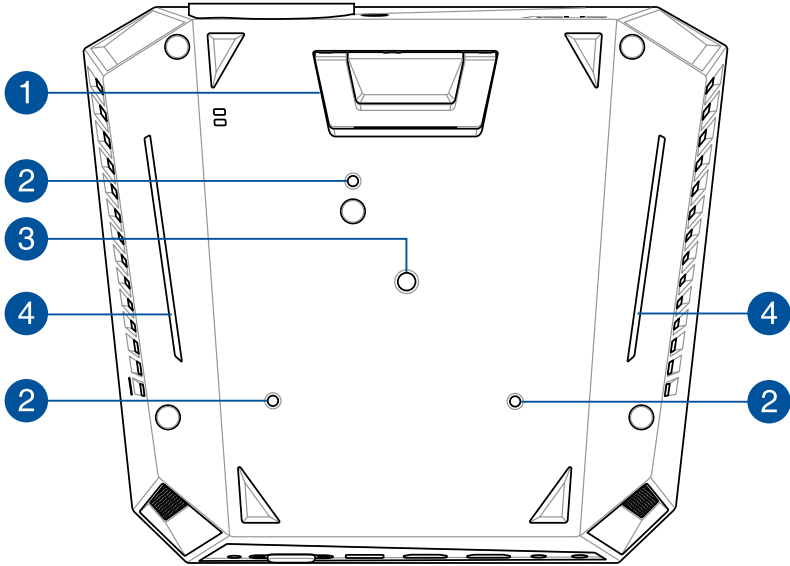

1 Built-in stand

This LED projector comes with a built-in stand that allows you to adjust the height of the projector by either 5.7 degrees or 8.2 degrees.

2 Ceiling mount holes

Use these holes to connect the LED projector to a ceiling mount.

3 Tripod socket

Connect the LED projector to a tripod using this socket.

4 AURA RGB LED

The AURA RGB LED provides several lighting schemes for you to customize your LED projector.

NOTE: For more details on customizing the AURA RGB LED, refer to the *Using the onscreen display menu* section in this manual.

Mounting your LED projector

Aside from using the LED projector as a tabletop device, you can also mount it on the ceiling using the ceiling mount holes on its bottom side.

IMPORTANT! Ask a specialist or your retailer for assistance when mounting your LED projector to the ceiling. A qualified professional should do the installation process.

NOTE:

- You may also refer to the Screen size and projection distance table section in this manual to specify the right distance for mounting your LED projector on the ceiling.
 - Keep a reasonable space between the bracket and the projector to allow for proper heat distribution.
 - In addition to the ceiling mount kit and screws, we also recommend using a metal bar or wire to hold the ceiling-mounted LED projector for added protection and to prevent it from falling due to natural causes such as earthquakes.
-

Projecting files from a mounted position

After mounting your LED projector, you need to change its image position settings to ensure that files are automatically flipped and projected correctly onscreen.

To change your image position settings:

1. Navigate to **Display > Projection Position** on your LED projector.
2. Select **Front Ceiling** or **Rear Ceiling** to change the settings of your LED projector.

Ceiling mount hole details

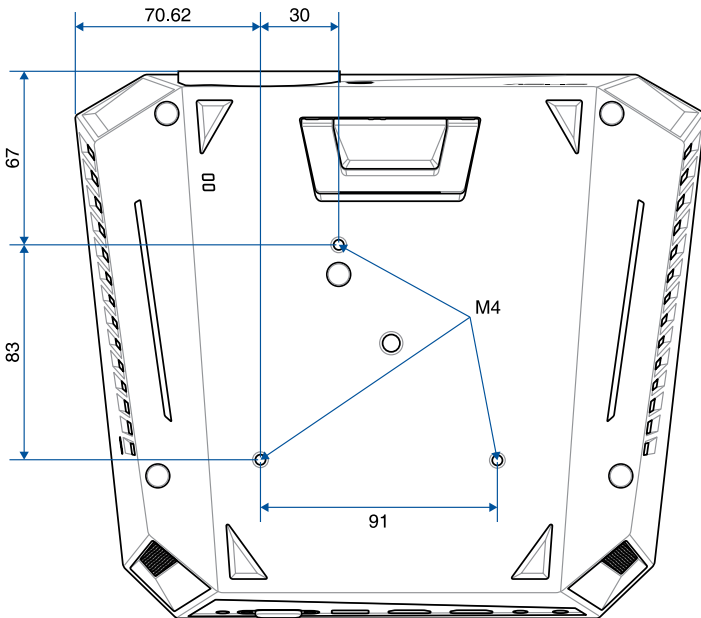

IMPORTANT! Ensure that the washers included in the ceiling mount kit are placed between the ceiling mount and screw to protect your LED projector and stabilize its position.

LED projector remote control

NOTE: Actual appearance may vary depending on model.

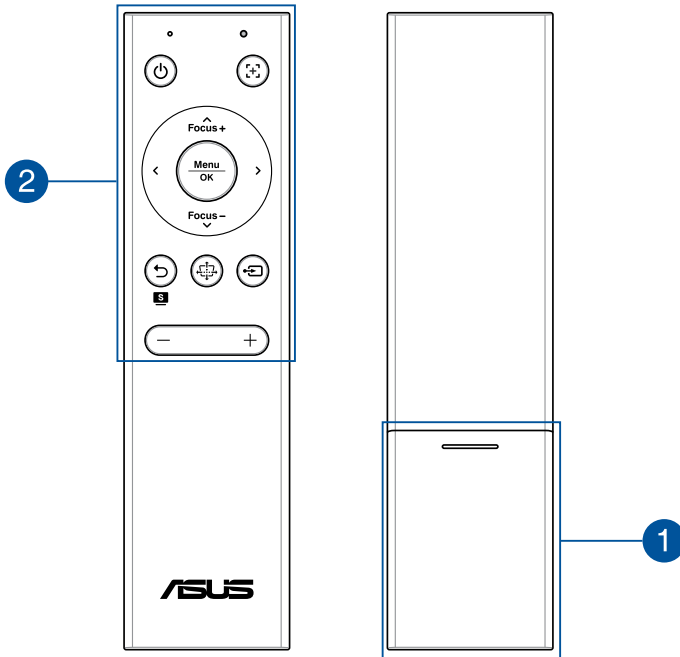













1 Battery compartment

The battery compartment allows you to use CR2032 lithium coin batteries to power your LED projector's remote control.

NOTE: For more details on using the battery compartment, refer to the *Replacing the battery* section in this manual.

2 Remote control buttons

These additional buttons allow you to use the LED projector from a distance of up to 8 meters.

-  **Power** - Press this button to turn your LED projector on or off.
-  **Auto focus** - Press this button to automatically focus the image.
-  **Back/Splendid** - Press this button to go back to the previous screen or select a Splendid mode for your LED projector.
-  **Keystone** - Press this button to adjust the keystone of your projection onscreen.
-  **Input** - Press this button to change the input source.
-  **Volume down** - Press this button to decrease the volume.
-  **Volume up** - Press this button to increase the volume.
-  **Focus +** **Focus up/Up** - Press this button to increase the focus or move up.
-  **Focus -** **Focus down/Down** - Press this button to decrease the focus or move down.
-  **Left** - Press this button to move left.
-  **Right** - Press this button to move right.
-  **Menu/OK** - Press this button to launch the menu or confirm a menu selection.

NOTE: For more details on the onscreen display menu, refer to the *Using the onscreen display menu* section in this manual.

Replacing the battery

A. Slide the battery cover down and remove it completely.

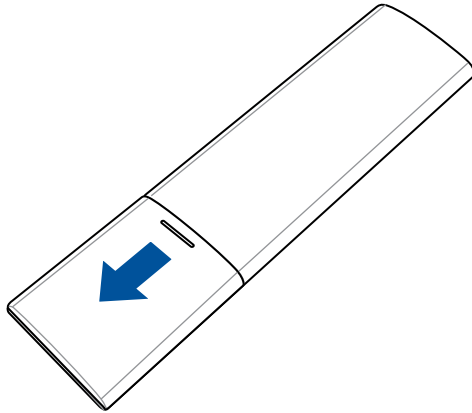

B. Remove the old batteries.

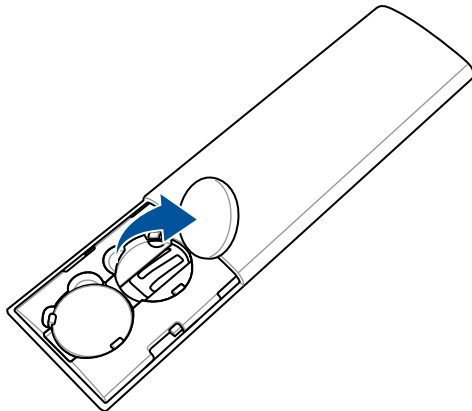

- C. Insert the new CR2032 lithium coin batteries with the positive sides (+) facing up.

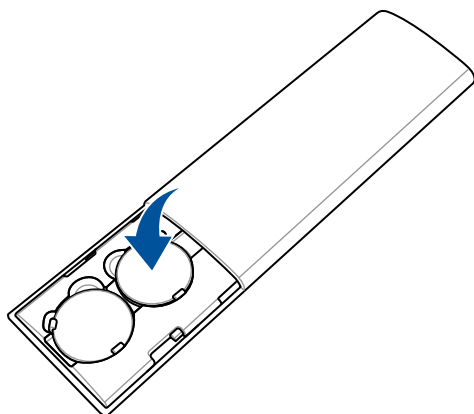

- D. Slide the battery cover up all the way in until you hear a soft click, indicating that the battery cover is locked back in place.

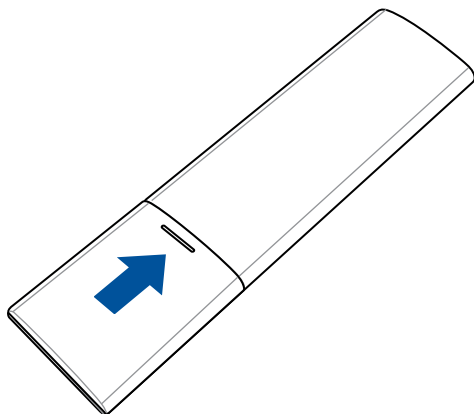

Remote control effective range

The remote sensor is located on the rear of your LED projector. The remote control must be held at an angle of ± 30 degrees perpendicular to the projector's remote control to function correctly. The distance between the remote control and the sensor should not exceed 8 meters (about 26 feet).

NOTE: Ensure sure that there are no obstacles between the remote control and the remote sensor on your LED projector.

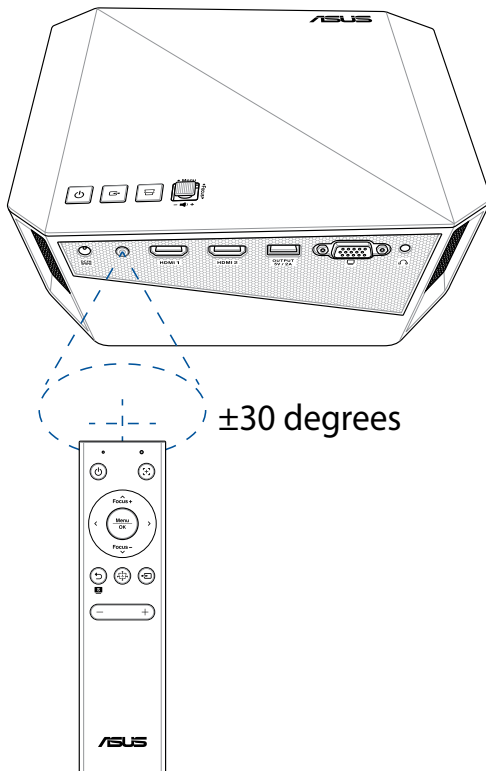

Chapter 2: ***Setting up***

Operating your LED projector

For your safety and to maintain the quality of this unit, refer to the following steps when operating your LED projector.

Connect the LED projector to the power adapter

- A. Connect the AC/DC power cord to the power adapter.
- B. Connect the AC power cord to a power source.
- C. Connect the DC power connector to your LED projector.

Power adapter information:

- Input voltage: 100-240Vac
- Input frequency: 50-60Hz
- Rating output current: 6.32A max. (120W)
- Rating output voltage: 19V

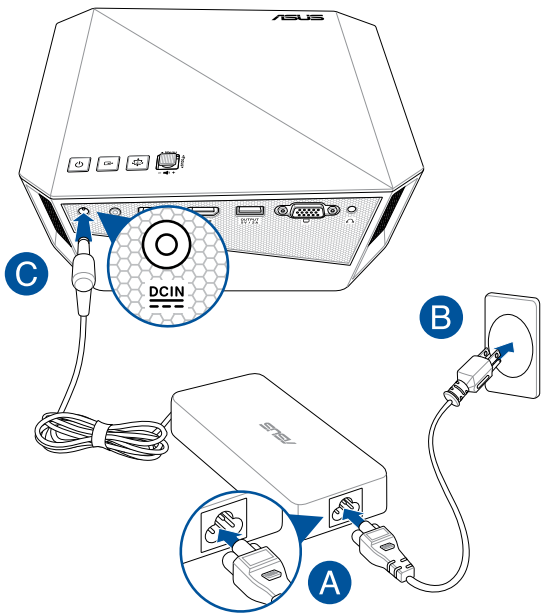

AC power cord requirements

Use the correct AC plug type according to your current location.

IMPORTANT! Contact your sales dealer if the AC power cord bundled with your LED projector does not match your local power source.

NOTE: We highly recommend that you use a video source device that also uses a grounding type plug to prevent signal interference due to voltage fluctuations.

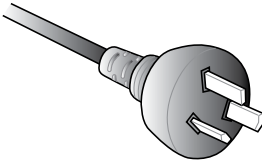

For Australia and Mainland China

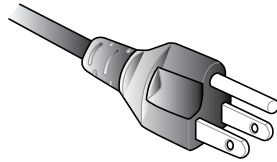

For U.S.A., Canada, and Taiwan

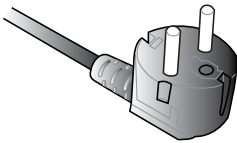

For Continental Europe

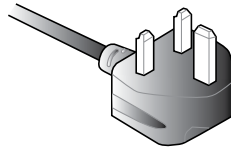

For U.K.

Connect the LED projector to your device

A. Audio output jack

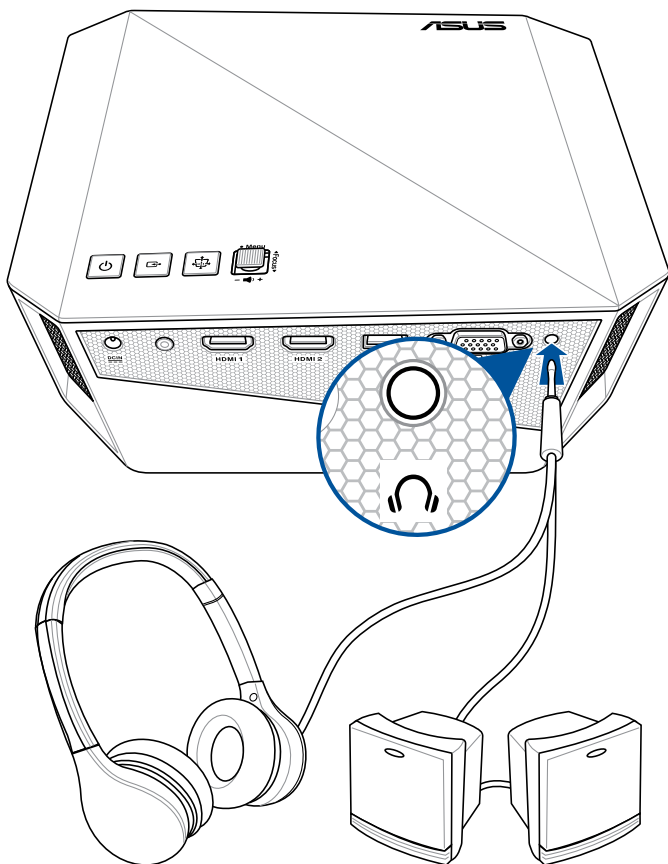

B. HDMI

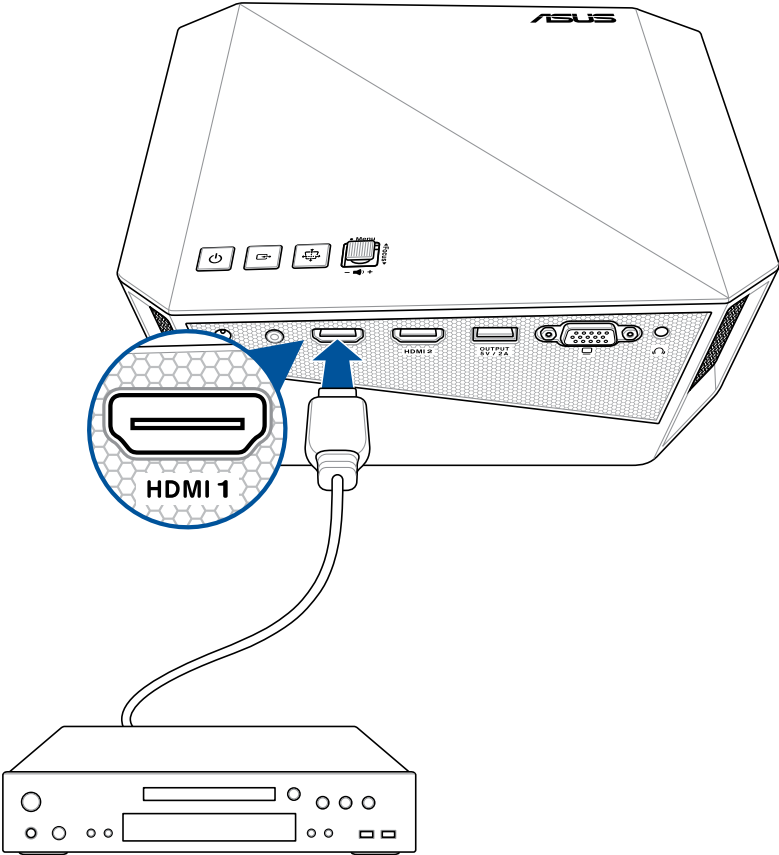

C. Power output (5V/2A)

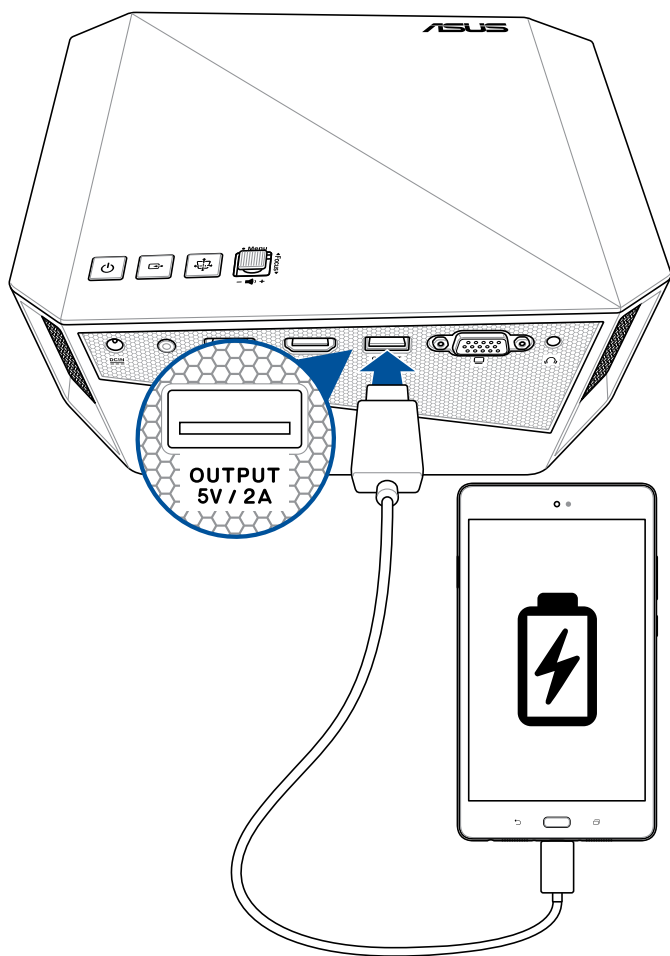

D. VGA

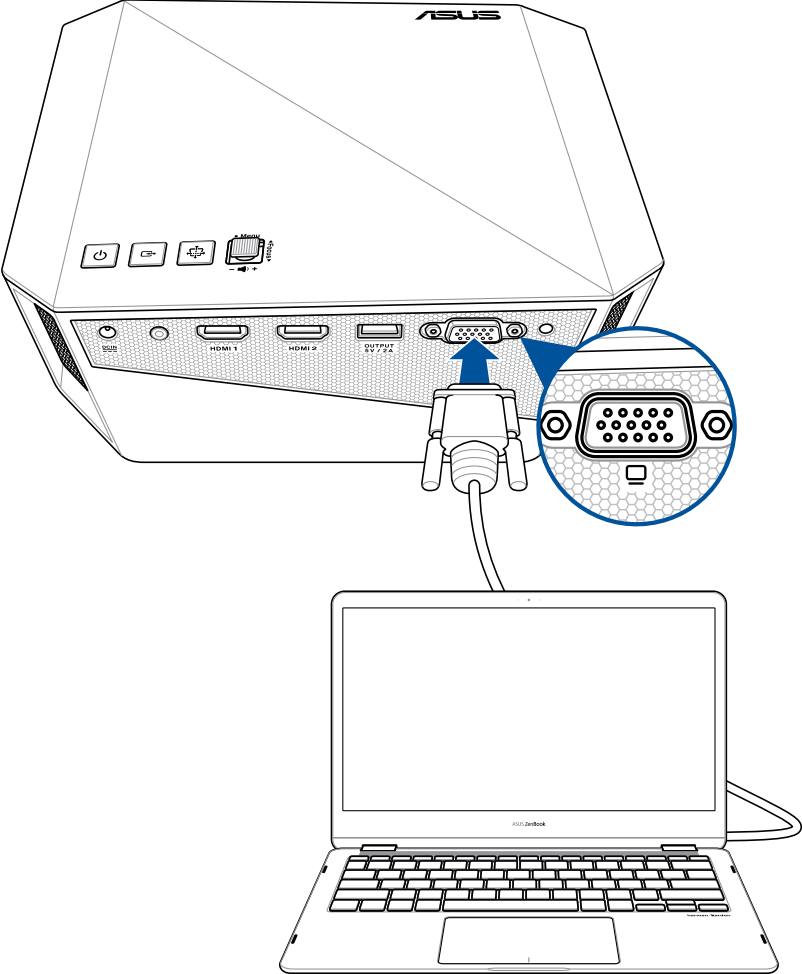

Adjust the height of the LED projector

Your LED projector comes with a built-in stand that helps adjust the image height onscreen.

WARNING! Ensure that the built-in stand is fully retracted before placing the LED projector inside the projector bag.

NOTES:

- Place the LED projector on a stable flat surface.
 - Keep a space of 30 cm or more between the sides of the LED projector.
 - Consult your dealer for special installation procedures like suspending the LED projector from the ceiling.
-

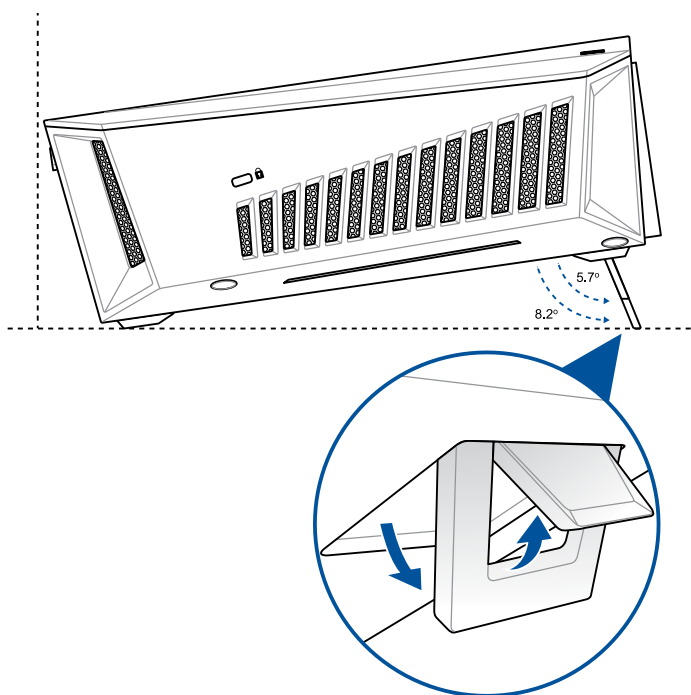

Screen size and projection distance table

Adjust the LED projector's distance from the screen using the table below.

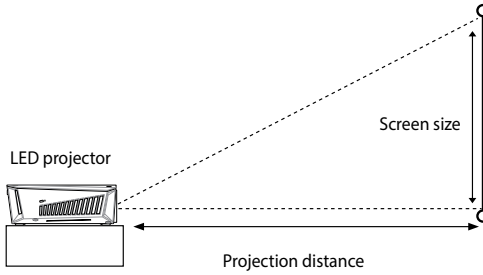

Screen Size						Projection Distance	
Screen Diagonal		Width		Height			
inch	cm	inch	cm	inch	cm	ft	m
25"	63.5	21.79	55.35	12.26	31.13	1.41	0.45
56.5"	143.51	49.24	125.08	27.70	70.36	3.28	1.00
65"	165.1	56.65	143.9	31.87	80.94	3.773	1.15
80"	203.2	69.73	177.11	39.22	99.62	4.66	1.42
100"	254	87.16	221.38	49.03	124.53	5.81	1.77
160"	406.4	135.68	344.63	84.80	215.4	9.28	2.83
210"	533.4	178.08	452.32	111.30	282.7	12.14	3.70

Press the power button

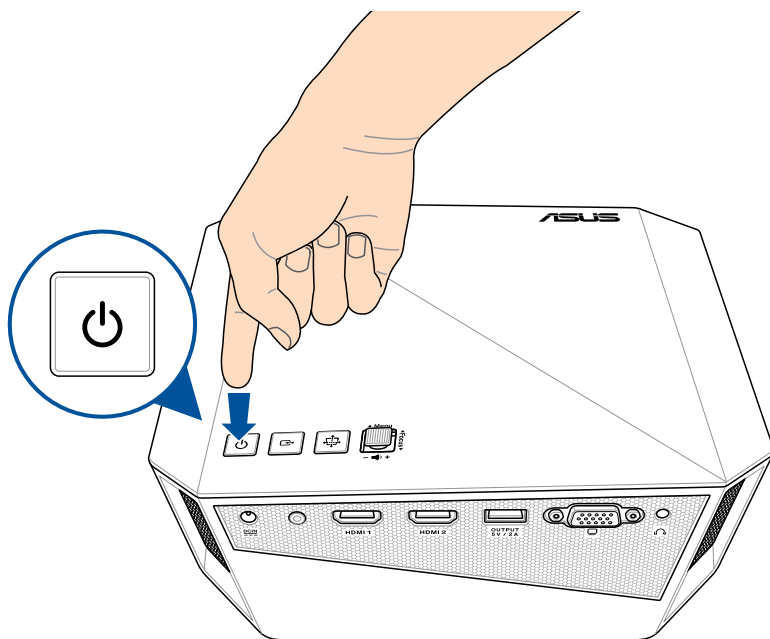

Adjust the image focus

Push the focus button on the LED projector up or down, or press the focus button on the remote control to adjust the image focus.

NOTE: Use a still image when adjusting the onscreen display.



OR

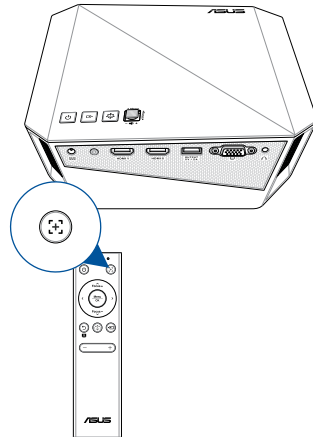
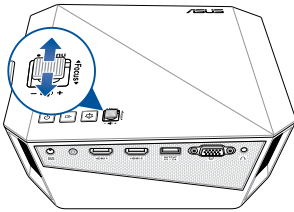

Chapter 3:
***Using the onscreen
display menu***

NOTE: The following screenshots are for reference only and may be updated without prior notice. Screenshots may also vary depending on the LED projector model.

Using your LED projector for the first time

Refer to the following steps when using your LED projector for the first time.

NOTE: Ensure that your LED projector is connected to the power adapter before turning it on for the first time. We strongly recommend that you use a grounded wall socket while using your LED projector on power adapter mode.

1. Set up your LED projector then press the power button.
2. Move the joystick left or right on your LED projector to browse through the available language options.
3. After you have chosen your preferred language, press the center of the joystick to set this language for use on your LED projector.
4. You may now start using your LED projector to display files from your input device. The **NO SIGNAL** screen may appear if no input device is connected or cannot be detected by the LED projector.

Adjusting your LED projector's settings

To adjust your LED projector settings:

1. Press the center of the joystick on your LED projector (or press the **Menu/OK** button on your remote control) to launch the onscreen display menu.
2. Move the joystick up or down (or press the **Focus up/Up** or **Focus down/Down** button on your remote control) to select the menu option you would like to adjust.
3. Press the center of the joystick (or press the **Menu/OK** button on your remote control) to open the selected option's settings.
4. Move the joystick left or right (or press the **Left** or **Right** button on your remote control) to adjust the settings according to your preference.
5. When finished, press the center of the joystick or press the **Menu/OK** button on your remote control) to save the new settings and go back to the home screen.

Remote control buttons

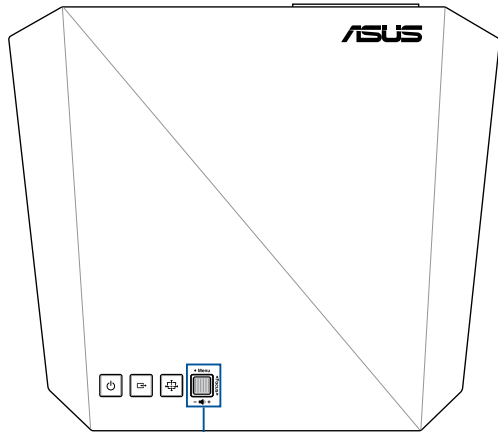
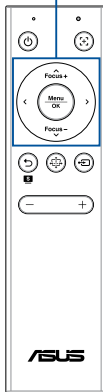

Joystick

Onscreen display menu options

Image

The options under this menu allows you to adjust image options to fine tune your image projection onscreen.

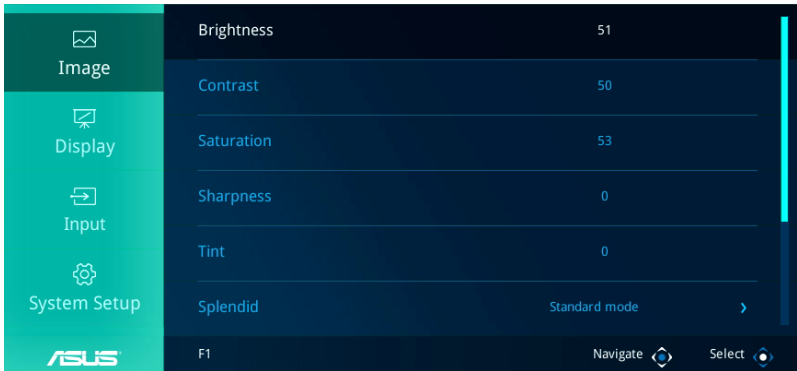

- **Brightness** - Select this menu option to adjust the brightness of your projection onscreen.
- **Contrast** - Select this menu option to adjust the contrast of your projection onscreen.
- **Saturation** - Select this menu option to adjust the saturation of your projection onscreen.
- **Sharpness** - Select this menu option to adjust the sharpness of your projection onscreen.
- **Tint** - Select this menu option to adjust the tint of your projection onscreen.
- **Splendid** - This option allows you to select a Splendid mode for your LED projector.
- **Color Temperature** - This option allows you to adjust the color temperature of your LED projector.

- **Wall Color** - This option allows you to choose a proper color according to the wall.
- **Gamma** - Select this menu option to adjust the gamma of your projection onscreen.

Display

The options under this menu allows you to adjust how the image projection will be displayed.



- **Auto Focus** - This option allows you to turn Auto Focus on or off.
- **Projection Position** - This option allows you to change the way your projections are oriented onscreen based from the current location of your LED projector.
- **Auto Ceiling Rotation** - This option allows you to turn Auto Ceiling detection on or off.
- **Keystone** - Select this menu option to adjust the keystone of your projection onscreen.
- **Aspect Ratio** - Select this menu option to adjust the screen ratio of your projection onscreen.

- **Digital Zoom** - This option allows you to zoom in, zoom out, and pan your projection onscreen.
- **3D** - Select this menu option to adjust 3D settings of your projection onscreen.

Input

The options under this menu allows you to select the input source for your LED projector.



- **Auto Source** - This option allows you to turn Auto Source on or off. Turn this option on to scan the connected devices to your LED projector automatically.
- **VGA/PC** - Select this menu option to project images from the VGA port.
- **HDMI 1** - Select this menu option to project images from the HDMI 1 port.
- **HDMI 2** - Select this menu option to project images from the HDMI 2 port.
- **Wireless Mirroring** - Select this menu option to wirelessly project images from a supported Android or Windows® 10 device.

System

The options under this menu allows you to configure system settings for your LED projector.

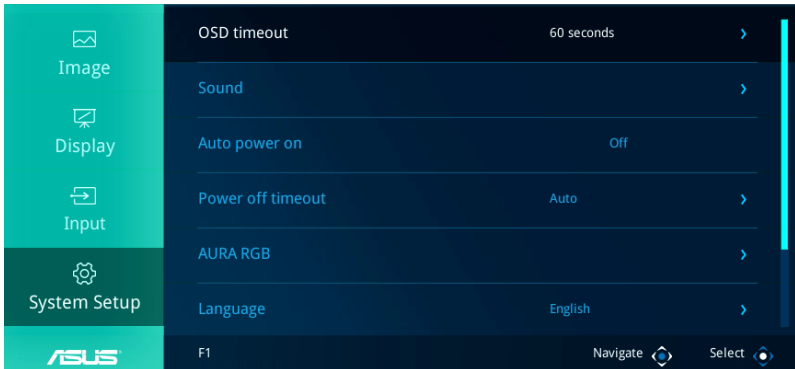

- **OSD Timeout** - This option allows you to set the number of seconds before the onscreen display menu disappears from your projection screen.
- **Sound** - This option allows you to adjust the projector sound settings.
- **Auto Power On** - This option allows the LED projector to automatically turn on when it is connected to a power source.
- **Power Off Timeout** - This option allows you to set the number of minutes before your LED projector automatically shuts down when not in use.
- **AURA RGB** - Select this menu option to adjust the AURA RGB LED of your projector.
- **Language** - This option allows you to select the language to use on your LED projector's onscreen display menu.

- **Information** - Select this menu option to see an overview of information about your LED projector.
- **Reset all** - This option allows you to reset all the settings you have currently set up for your LED projector.

NOTE: Please wait for at least eight (8) seconds for the reset process to complete, then reselect a language.

Turning off your LED projector

1. Press the power button.

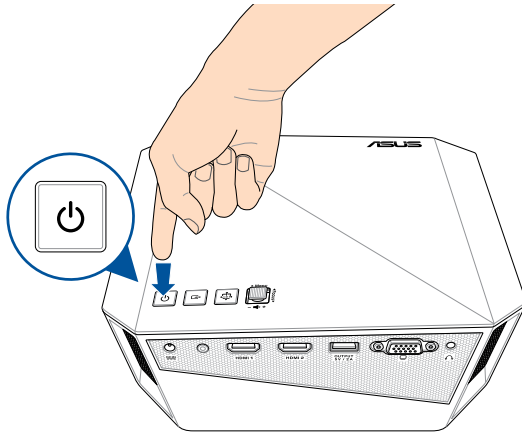

2. When the following screen appears, press the power button again to completely turn off your LED projector.

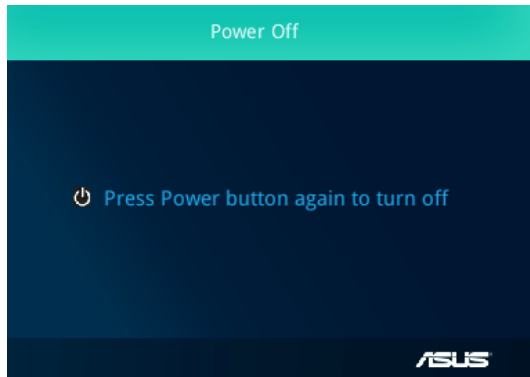

Using 3D glasses

Your LED projector supports 3D technology for an enhanced viewing experience.

IMPORTANT! Purchase DLP Link 3D glasses. Your 3D files must be compatible with the 3D format.

NOTE: For more details on viewing 3D files, refer to the user guide that comes with your 3D glasses.

To view 3D files:

1. Play your 3D file, then navigate to **Display > 3D** on your LED projector.

NOTE: The 3D mode is set to **Off** by default.

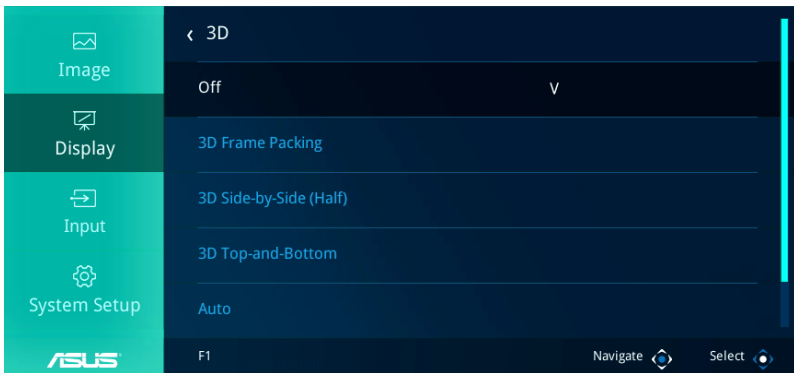

2. Select **Auto** to allow your LED projector to automatically select a 3D mode best suited for your 3D file.

NOTE: Select a 3D mode manually if your LED projector cannot detect which 3D mode to use.

IMPORTANT! Set the 3D mode back to **Off** to exit 3D mode.

Multi-language versions

Download other language versions of this E-Manual via this website:

<https://www.asus.com/support>

Appendices

Federal Communications Commission Statement

This equipment has been tested and found to comply with the limits for a class B digital device, pursuant to Part 15 of the Federal Communications Commission (FCC) rules. These limits are designed to provide reasonable protection against harmful interference in a residential installation. This equipment generates, uses, and can radiate radio frequency energy and, if not installed and used in accordance with the instructions, may cause harmful interference to radio communications. However, there is no guarantee that interference will not occur in a particular installation. If this equipment does cause harmful interference to radio or television reception, which can be determined by turning the equipment off and on, the user is encouraged to try to correct the interference by one or more of the following measures:

- Reorient or relocate the receiving antenna.
- Increase the distance between the equipment and receiver.
- Connect the equipment to an outlet on a different circuit than that which the receiver is connected to.
- Consult the dealer or an experienced radio/TV technician for help.

This device complies with Part 15 of the FCC Rules. Operation is subject to the following two conditions:

1. This device may not cause harmful interference, and
2. This device must accept any interference that may cause undesired operation.

Compliance Statement of Innovation, Science and Economic Development Canada (ISED)

This device complies with Innovation, Science and Economic Development Canada licence exempt RSS standard(s). Operation is subject to the following two conditions: (1) this device may not cause interference, and (2) this device must accept any interference, including interference that may cause undesired operation of the device.

CAN ICES-3(B)/NMB-3(B)

Déclaration de conformité de Innovation, Sciences et Développement économique Canada (ISED)

Le présent appareil est conforme aux CNR d'Innovation, Sciences et Développement économique Canada applicables aux appareils radio exempts de licence. L'exploitation est autorisée aux deux conditions suivantes : (1) l'appareil ne doit pas produire de brouillage, et (2) l'utilisateur de l'appareil doit accepter tout brouillage radioélectrique subi, même si le brouillage est susceptible d'en compromettre le fonctionnement.

CAN ICES-3(B)/NMB-3(B)

Regional notice for California



WARNING

Cancer and Reproductive Harm -
www.P65Warnings.ca.gov

Global Environmental Regulation Compliance and Declaration

ASUS follows the green design concept to design and manufacture our products, and makes sure that each stage of the product life cycle of ASUS product is in line with global environmental regulations. In addition, ASUS disclose the relevant information based on regulation requirements.

Please refer to <http://csr.asus.com/english/Compliance.htm> for information disclosure based on regulation requirements ASUS is complied with:

Japan JIS-C-0950 Material Declarations

EU REACH SVHC

Korea RoHS

ASUS Recycling/Takeback Services

ASUS recycling and takeback programs come from our commitment to the highest standards for protecting our environment. We believe in providing solutions for you to be able to responsibly recycle our products, batteries, other components as well as the packaging materials. Please go to <http://csr.asus.com/english/Takeback.htm> for detailed recycling information in different regions.

Specifications for F1 series LED projector

		F1
Display	Display Technology	0.47" DLP®
	Light Source	R/G/B LED
	Light Source Life	30,000 hours (Max)
	True Resolution (native)	FHD 1920x1080
	Light Output (Max)	1200 Lumens
	Contrast Ratio	3500:1(DCR), 800:1 (Typical)
	Color Saturation (NTSC)	100%
	Display Colors	16.7 Million Colors
Projection Lens	Throw Ratio (@16:9)	0.8:1 (56.5" @ 1m)
	Projection Distance	0.43 ~ 3.7 meters
	Projection/Screen Size	25 ~ 210 inches
	Projection Offset	105 ±5 %
	Zoom Ratio	Fixed
Video Features	Picture Modes	6 Modes (Standard Mode, Dynamic Mode, sRGB Mode, Scenery Mode, Theater Mode, Game Mode)
	Keystone adjustment	Vertical / Horizontal
	Auto Keystone	Yes (Vertical)
	Aspect Ratio	Auto /16:10 / 16:9 / 4:3
	Projector Placement	Front Table, Rear Table, Front Ceiling, Rear Ceiling
Audio Features	Built-in speakers	3W x 2 (Stereo) + 8W (Woofer) 2.1 Channel speaker with Harman Kardon®certified

(continued on the next page)

		F1
Signal Frequency	Analog Signal Frequency	Horizontal: 15.37 ~ 91.14 KHz Vertical: 24 ~ 60 Hz
	Digital Signal Frequency	Horizontal: 15.37 ~ 91.14 KHz Vertical: 24 ~ 120 Hz
Power	Power On Mode	<120W
	Standby Mode	<0.5W
Noise	Acoustic Noise	Standard mode: 32dB - 34dB Theater mode: 28dB - 30dB
Input or Output	PC Signal Input	1 x D-sub 2 x HDMI (HDCP support)
	Audio Out	Earphone out
	USB port	Yes (1 x Type A for 5V/2A charging)
Wireless	Wi-Fi	802.11 a/b/g/n @ 2.4GHz and 5GHz
Mechanical Design	Chassis Colors	Black
	Tripod Socket	Yes
	Supporting Stand	Yes (Two steps)
	Ceiling Mount	Yes
	Lens Cover	Yes
Security	Kensington lock	Yes
Dimension	Physical Dimension	250(W) x 75(H) x 210(D) mm
	Box Dimension	496(W) x 115(H) x 302(D) mm

(continued on the next page)

		F1
Weight	Net Weight (Esti.)	1.80 Kg
	Gross Weight (Esti.)	3.80 Kg
Operating Temperature		0 ~ 40° C
Operating Humidity		20 ~ 90%
Accessories		Carrying bag, power adapter, power cord, HDMI cable, Quick Start Guide, remote control, warranty card

- * Specifications are subject to change without prior notice.
- ** Product availability may vary by region.
- *** All brand and product names mentioned are trademarks of their respective companies.

Supported PC Timings

VGA

Resolution	Mode	Refresh rate (Hz)	H-frequency (kHz)
720 x 400	720 x 400_70	70.087	31.469
640 x 480	VGA_60	59.94	31.469
	VGA_72	72.809	37.861
	VGA_75	75	37.5
800 x 600	SVGA_60	60.317	37.879
	SVGA_72	72.188	48.077
	SVGA_75	75	46.875
1024 x 768	XGA_60	60.004	48.363
	XGA_70	70.069	56.476
	XGA_75	75.029	60.023
1152 x 864	1152 x 864_60	60	
1280 x 720	1280 x 720_60	60	45
	1280 x 720_120	120	
1280 x 800	WXGA_60	59.81	49.702
1280 x 1024	SXGA_60	60.02	63.981
	SXGA_75	75.025	79.976
1280 x 960	1280 x 960_60	60	60
1360 x 768	1360 x 768_60	60.015	47.712
1440 x 900	WXGA+_60	59.887	55.935
1600 x 1200	UXGA	60	75
1680 x 1050	1680 x 1050_60	59.95	62.29
640 x 480@67Hz	MAC13	66.667	35
832 x 624@75Hz	MAC16	74.546	49.722
1024 x 768@75Hz	MAC19	74.93	60.241
1920 x 1080@60Hz	1920 x 1080_60	60	67.5

3D Video Format Timings (HDMI only)

Timing	Frame Packing	Side-by-side(Half)	Top-and-Bottom
1280 x 720p @59.94/60 Hz	v	v	v
1280 x 720p @50Hz	v	v	v
1280 x 720p @23.98/24 Hz	v		
1280 x 720p @29.97/30 Hz	v		
1920 x 1080i @59.94/60Hz	v	v	
1920 x 1080i @50Hz	v	v	
1920 x 1080p @23.98/24 Hz	v	v	v
1920 x 1080p @29.97/30 Hz	v		v
1920 x 1080p @59.94/60Hz			v
1920 x 1080p @50Hz			v

HDMI (PC)

Resolution	Mode	Refresh rate (Hz)	H-frequency (kHz)
720 x 400	720 x 400_70	70.087	31.469
640 x 480	VGA_60	59.94	31.469
	VGA_72	72.809	37.861
	VGA_75	75	37.5
800 x 600	SVGA_60	60.317	37.879
	SVGA_72	72.188	48.077
	SVGA_75	75	46.875
1024 x 768	XGA_60	60.004	48.363
	XGA_70	70.069	56.476
	XGA_75	75.029	60.023
1152 x 864	1152 x 864_60	60	
1280 x 720	1280 x 720_60	60	45
	1280 x 720_120	120	
1280 x 800	WXGA_60	59.81	49.702
1280 x 1024	SXGA_60	60.02	63.981
	SXGA_75	75.025	79.976
1280 x 960	1280 x 960_60	60	60
1360 x 768	1360 x 768_60	60.015	47.712
1440 x 900	WXGA+_60	59.887	55.935
1680 x 1050	1680 x 1050_60	59.95	62.29
640 x 480@67Hz	MAC13	66.667	35
832 x 624@75Hz	MAC16	74.546	49.722
1024 x 768@75Hz	MAC19	74.93	60.241
1920 x 1080@60Hz	1920 x 1080_60	60	67.5

HDMI (Video)

Timing	Resolution	Vertical frequency (Hz)	H-frequency (kHz)
480i	720(1440) x 480	59.94	15.73
480p	720 x 480	59.94	31.47
576i	720(1440) x 576	50	15.63
576p	720 x 576	50	31.25
720/50p	1280 x 720	50	37.5
720/60p	1280 x 720	60	45
1080/50i	1920 x 1080	50	28.13
1080/60i	1920 x 1080	60	33.75
1080/50P	1920 x 1080	50	56.25
1080/60P	1920 x 1080	60	67.5
1080/24P	1920 x 1080	24	

Simplified EU Declaration of Conformity

ASUSTek Computer Inc. hereby declares that this device is in compliance with the essential requirements and other relevant provisions of Directive 2014/53/EU. Full text of EU declaration of conformity is available at <https://www.asus.com/support/>

The WiFi operating in the band 5150-5350MHz shall be restricted to indoor use for countries listed in the table below:

AT	BE	BG	CZ	DK	EE	FR
DE	IS	IE	IT	EL	ES	CY
LV	LI	LT	LU	HU	MT	NL
NO	PL	PT	RO	SI	SK	TR
FI	SE	CH	UK	HR		



F1 output power table:

Function	Frequency	Maximum Output Power (EIRP)
WiFi	2412 - 2472 MHz	18.78 dBm
	5150 - 5350 MHz	18.47 dBm
	5470 - 5725 MHz	18.02 dBm