



## MANUAL

ENGLISH | NEDERLANDS | DEUTSCH | FRANÇAIS | ESPAÑOL | ITALIANO | PORTUGUÊS  
POLSKI | ČESKY | MAGYAR | SLOVENSKÝ

**SAFESCAN 1250**

# COIN COUNTER & SORTER

# INTRODUCTION

Thank you for purchasing the Safescan 1250 Coin Counter and Sorter, a product of outstanding ease-of-use and quality. The Safescan 1250 quickly counts coins and sorts them each in its dedicated separate cup, which ensures efficient cash handling.

## PACKAGE CONTENTS

The retail box contains the following items:

- Safescan 1250 Coin counter
- 8 Coin cups
- User manual (multi lingual)
- 8 Coin tubes (included with EURO model only)

## 1. PRODUCT

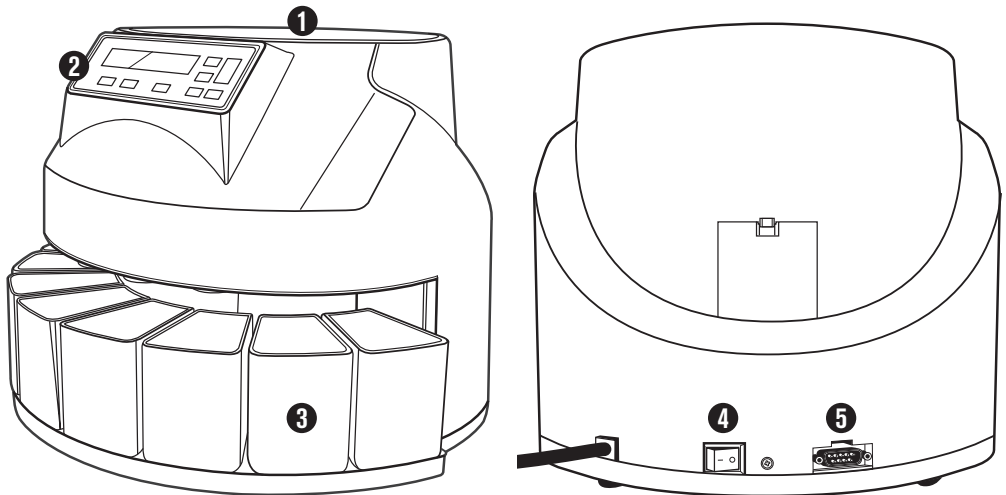

- 1. Hopper
- 2. Display / Function buttons
- 3. Coin cups
- 4. Power switch
- 5. Printer port
- 6. Coin tubes (with EURO model only)

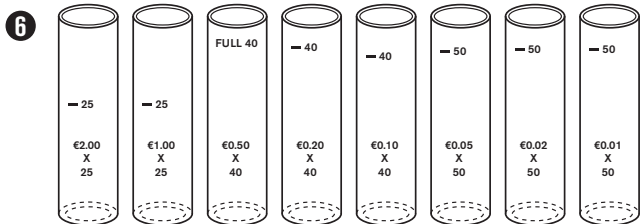

## 2. INSTALLING YOUR SAFESCAN 1250

1. Connect the power cord of the coin counter into the mains outlet (AC 220~240V).

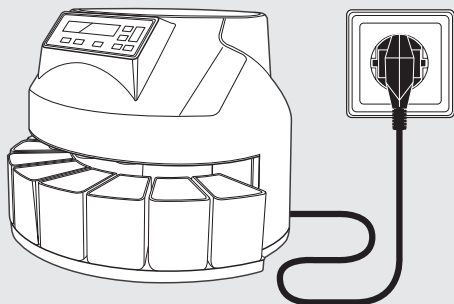

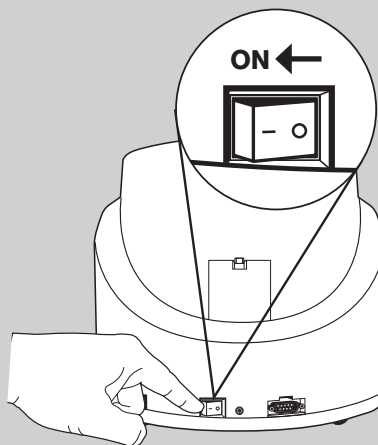

2. Press the power switch at the rear to power **ON** the counter.

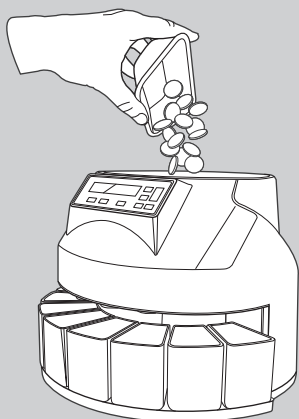

## 3. COUNTING COINS

1. Put the coins in the hopper. The coins do not have to be sorted in advance.



2. Press the  key to start counting. The coins are sorted by size, each denomination is placed in its own cup (from left to right: largest to smallest diameter coin).

For Euro coins, the coin tubes can also be used instead of the coin cups.

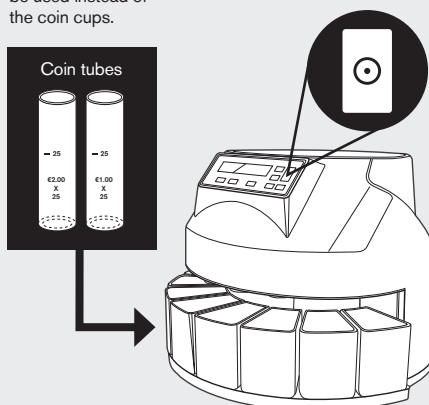

# 4. DISPLAY AND CONTROLS

- 01. Display
- 02. Print count result on optional printer
- 03. Show count result report on display
- 04. Select denomination for batch setting
- 05. Set batch quantity per 20 or 50 coins
- 06. Set batch quantity per 1 coin - UP
- 07. Set batch quantity per 1 coin - DOWN
- 08. Clear count result
- 09. Start counting

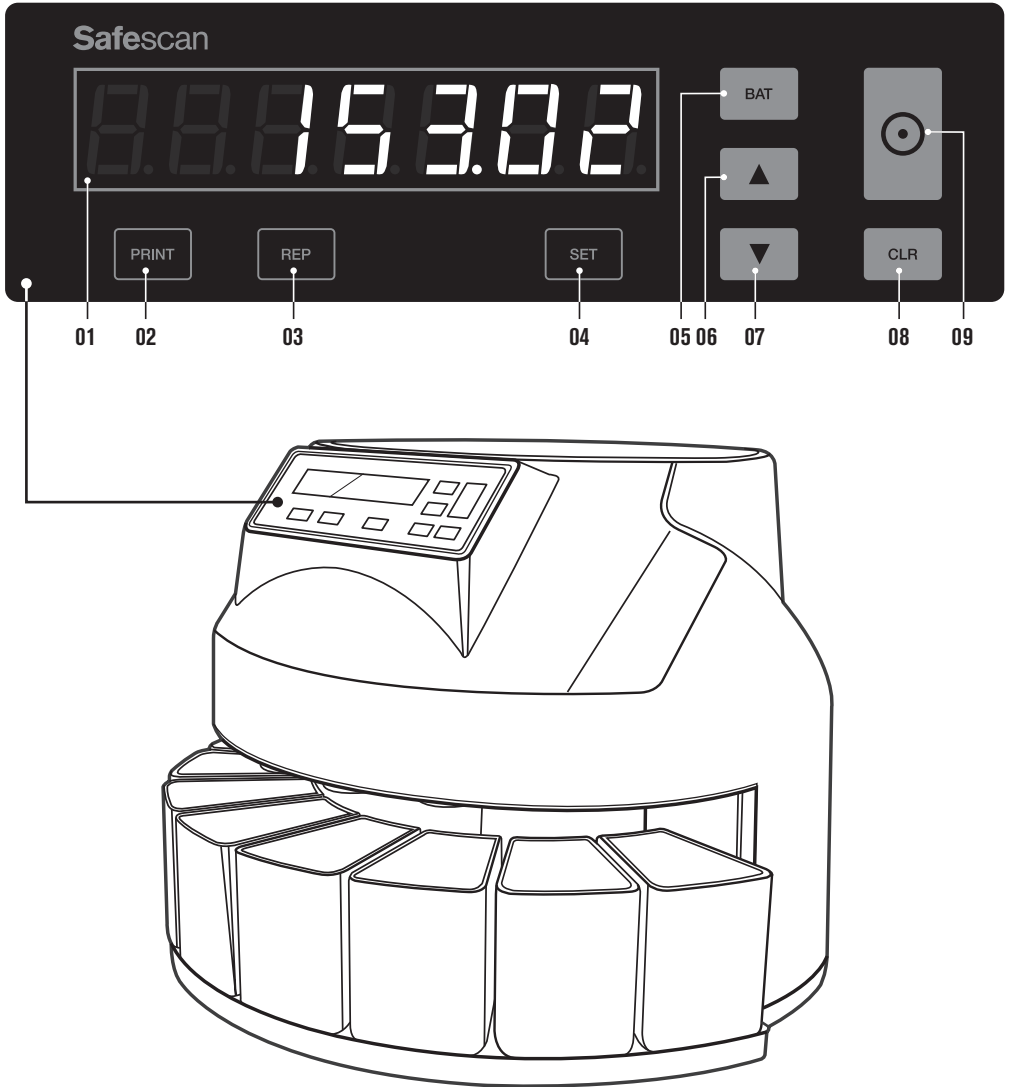



## 5. COUNTING COMPLETED: VIEW TOTALS PER DENOMINATION



1. When counting is completed, the total value of the counted coins is displayed. To view the amount of coins per denomination, press the  key.



2. The number of coins is displayed, starting with the coin denomination with the largest diameter. Use the  and  keys to select the other coin denominations.

## 6. BATCH FUNCTION

The batch function enables you to create equal batches of coins. The counter will stop when the selected batch quantity has been reached. There are 2 options:



1. **Default batch amounts.** The Safescan 1250 comes standard with default set batch amounts per denomination. Press  to toggle through the batch settings of each denomination, starting with the coin with the largest diameter.



2. **Change batch amount.** Press the  key until the desired coin denomination has been reached.



3. Press the  key to select a batch amount in steps of 20 (from 1 to 200 coins) and 50 (from 200 to 999 coins).



4. To set a different batch amount, use the  and  keys to set batch amounts in steps of 1.

## 7. MAINTENANCE

---

For continuous efficient operation it is required to clean the internal mechanism and the sensors of your coin counter regularly. If the internal sensors of the device become dirty it will lead to miscounting and/or device malfunctioning. For detailed maintenance instructions please visit the Safescan website: [www.safescan.com](http://www.safescan.com).

**IMPORTANT:** make sure there are no foreign currency coins inserted and that there are no other objects such as paperclips, staples etc. inserted in the device since this will lead to device malfunctioning.

---

## 8. USE WITH THE OPTIONAL SAFESCAN TP-230 PRINTER

The Safescan 1250 can be connected to the optional Safescan TP-230 thermal printer, which will provide you with a detailed breakdown of the count results. Before you can start using the printer, the baudrate setting of the printer needs to be adjusted from 9600 (default setting of printer) to 1200. Please follow the steps below.

### 1. ENTER PARAMETER SETUP MODE

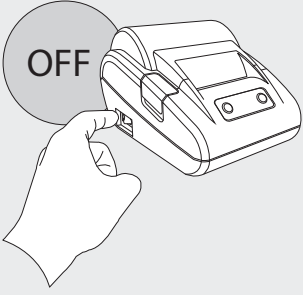
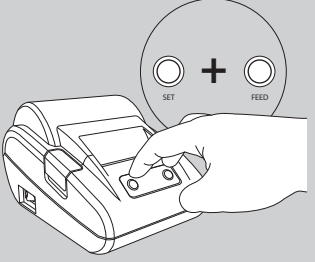
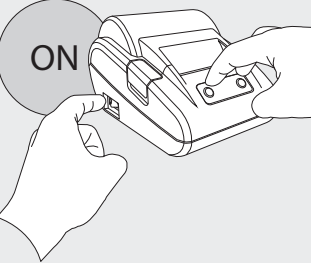
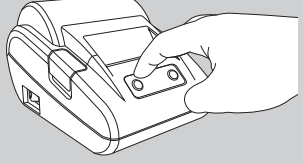
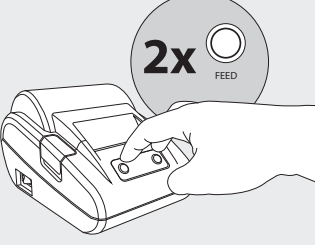
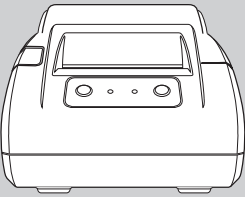
<p><b>A.</b> Switch off the power</p> 	<p><b>B.</b> Press the SET and FEED buttons simultaneously</p>  <p>The red error LED will blink.</p>	<p><b>C.</b> Switch on the power. Keep SET and FEED pressed</p> 
<p><b>D.</b> Release the FEED button whilst keeping SET pressed</p> 	<p><b>E.</b> Press FEED twice whilst keeping SET pressed</p> 	<p><b>F.</b> Release the SET button</p> 

The printer is now in the **Parameter setup mode** and it will print the first parameter of the settings menu (baudrate).

### 2. SELECT THE PARAMETER YOU WISH TO CHANGE

By pressing SET, you can scroll through the various items that can be changed. This sequence is a loop and is as follows:

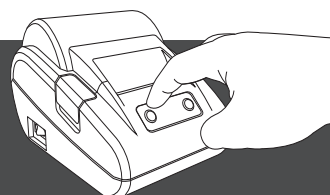

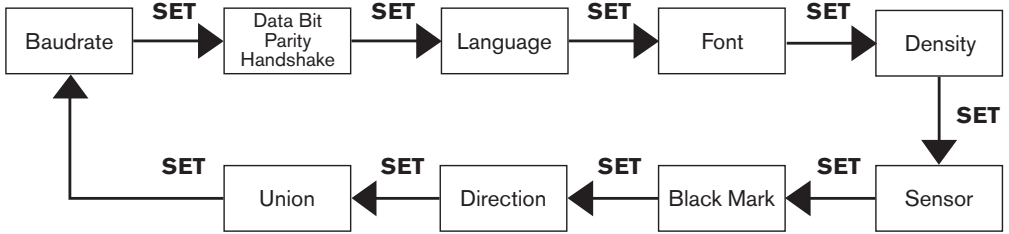

Every time you press SET, the printout will show which parameter is selected, plus its current setting. The next step shows how to change the setting.

### 3. CHANGE THE PRINTER BAUDRATE

Once you are in the setting for the baudrate adjustment, the desired value can be selected by pressing FEED. Every time you press FEED, the applicable value will be printed. Keep pressing FEED until "1200" is printed. The baudrate setting sequence is a loop and is as follows:

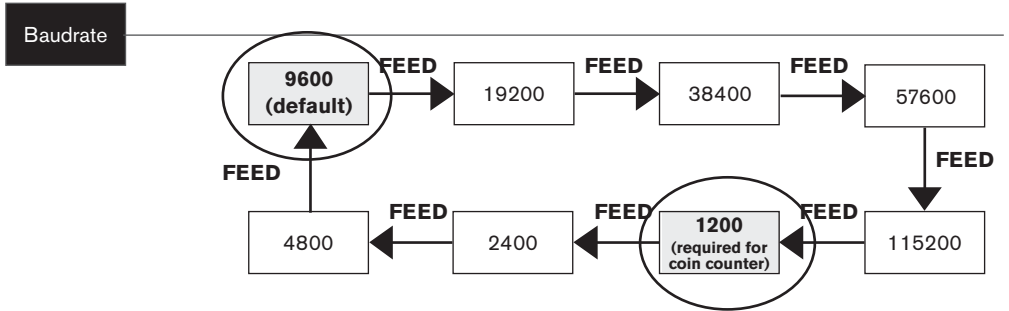

### 4. SAVE THE SETTINGS.

<p><b>A.</b> Press both the SET and FEED button</p>	<p><b>B.</b> Release FEED while still pressing SET</p>	<p><b>C.</b> Release the SET button</p>
---	--	---

The printout will now show **Exit Set mode**. The settings have been saved.

**PLEASE NOTE:** When the changes are not saved, the printer will go back to default settings after it has been switched off.

For detailed operating instructions please refer to the Safescan TP-230 user manual, included with the printer.



## 9. CONNECTING AND USING THE PRINTER

Connect the printer to the coin counter with a 9-pins serial cable (M/F), included with the printer.

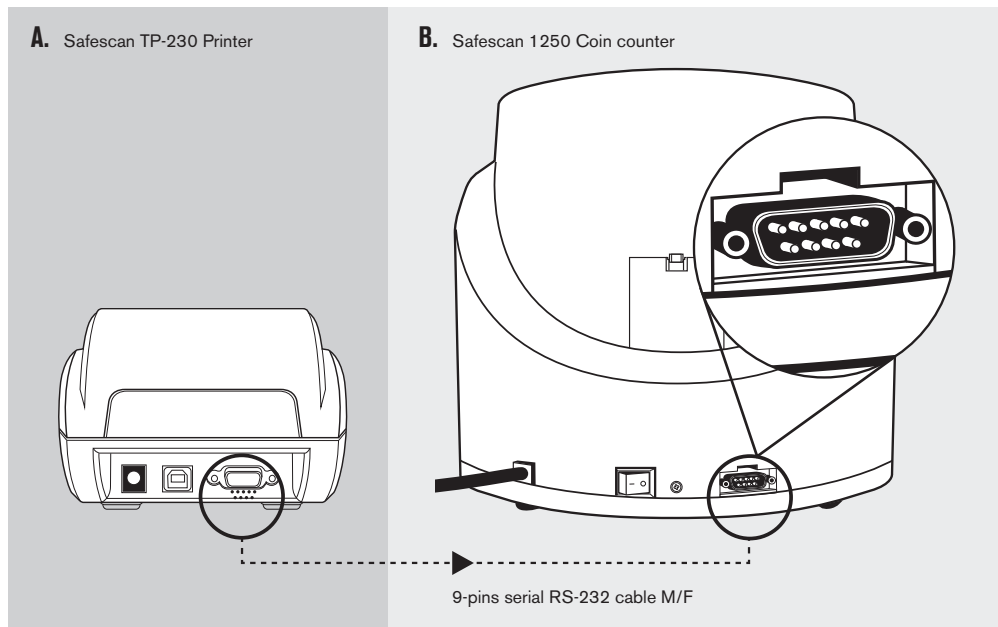

After counting has finished, press [PRINT] on the coin counter to print a detailed counting report, split per denomination.

## TECHNICAL SPECIFICATIONS

<b>Operating temperature:</b>	0° ~ 40° celsius	<b>Counting number display:</b>	4-digit LED
<b>Ambient humidity:</b>	30 ~ 80%	<b>Power supply:</b>	AC 220~240V / 50Hz
<b>Hopper capacity:</b>	300 ~ 500 coins	<b>Power consumption:</b>	45W (max)
<b>Receiving cups capacity:</b>	80 ~ 150 coins	<b>Dimensions:</b>	35.5 x 33 x 26.6 cm
<b>Coin tube capacity (Euro only):</b>	40 ~ 50 coins	<b>Net weight:</b>	4.5 kg
<b>Batch preset number display:</b>	3-digit LED	<b>Counting speed:</b>	220 coins per minute

## WARRANTY

Warranty procedure: contact Safescan for assistance: [www.safescan.com](http://www.safescan.com)

**CE** This product is in compliance with the essential requirements and other relevant provisions of the applicable European directives. The Declaration of Conformity (DoC) is available at [www.safescan.com](http://www.safescan.com)

 Take the device to a recycling centre if you want to dispose of it. Never throw any electronic device away with the household waste.

**SAFESCAN® is a registered trademark of Solid Control Holding B.V.**

No part of this manual may be reproduced in any form, by print, copy or in any other way without prior written permission of Solid Control Holding B.V. Solid Control Holding B.V. reserves all intellectual and industrial property rights such as any and all of their patent, trademark, design, manufacturing, reproduction, use and sales rights. All information in this manual is subject to change without prior notice. Solid Control Holding B.V. is not liable and/or responsible in any way for the information provided in this manual.

---

**www.safescan.com**  
info@safescan.com