

E10971
First Edition
April 2016

HDMI™
HIGH-DEFINITION MULTIMEDIA INTERFACE

ASUS ZenBeam™

IN SEARCH OF INCREDIBLE



E-Manual

ASUS

COPYRIGHT AND WARRANTY INFORMATION

No part of this manual, including the products and software described in it, may be reproduced, transmitted, transcribed, stored in a retrieval system, or translated into any language in any form or by any means, except documentation kept by the purchaser for backup purposes, without the express written permission of ASUSTeK COMPUTER INC. ("ASUS").

Product warranty or service will not be extended if: (1) the product is repaired, modified or altered, unless such repair, modification or alteration is authorized in writing by ASUS; or (2) the serial number of the is defaced or missing.

ASUS PROVIDES THIS MANUAL "AS IS" WITHOUT WARRANTY OF ANY KIND, EITHER EXPRESS OR IMPLIED, INCLUDING BUT NOT LIMITED TO THE IMPLIED WARRANTIES OR CONDITIONS OF MERCHANTABILITY OR FITNESS FOR A PARTICULAR PURPOSE. IN NO EVENT SHALL ASUS, ITS DIRECTORS, OFFICERS, EMPLOYEES OR AGENTS BE LIABLE FOR ANY INDIRECT, SPECIAL, INCIDENTAL, OR CONSEQUENTIAL DAMAGES (INCLUDING DAMAGES FOR LOSS OF PROFITS, LOSS OF BUSINESS, LOSS OF USE OR DATA, INTERRUPTION OF BUSINESS AND THE LIKE), EVEN IF ASUS HAS BEEN ADVISED OF THE POSSIBILITY OF SUCH DAMAGES ARISING FROM ANY DEFECT OR ERROR IN THIS MANUAL OR PRODUCT.

Products and corporate names appearing in this manual may or may not be registered trademarks or copyrights of their respective companies, and are used only for identification or explanation and to the owners' benefit, without intent to infringe.

SPECIFICATIONS AND INFORMATION CONTAINED IN THIS MANUAL ARE FURNISHED FOR INFORMATIONAL USE ONLY, AND ARE SUBJECT TO CHANGE AT ANY TIME WITHOUT NOTICE, AND SHOULD NOT BE CONSTRUED AS A COMMITMENT BY ASUS. ASUS ASSUMES NO RESPONSIBILITY OR LIABILITY FOR ANY ERRORS OR INACCURACIES THAT MAY APPEAR IN THIS MANUAL, INCLUDING THE PRODUCTS AND SOFTWARE DESCRIBED IN IT.

Copyright © 2016 ASUSTeK COMPUTER INC. All Rights Reserved.

LIMITATION OF LIABILITY

Circumstances may arise where because of a default on ASUS' part or other liability, you are entitled to recover damages from ASUS. In each such instance, regardless of the basis on which you are entitled to claim damages from ASUS, ASUS is liable for no more than damages for bodily injury (including death) and damage to real property and tangible personal property; or any other actual and direct damages resulted from omission or failure of performing legal duties under this Warranty Statement, up to the listed contract price of each product.

ASUS will only be responsible for or indemnify you for loss, damages or claims based in contract, tort or infringement under this Warranty Statement.

This limit also applies to ASUS' suppliers and its reseller. It is the maximum for which ASUS, its suppliers, and your reseller are collectively responsible.

UNDER NO CIRCUMSTANCES IS ASUS LIABLE FOR ANY OF THE FOLLOWING: (1) THIRD-PARTY CLAIMS AGAINST YOU FOR DAMAGES; (2) LOSS OF, OR DAMAGE TO, YOUR RECORDS OR DATA; OR (3) SPECIAL, INCIDENTAL, OR INDIRECT DAMAGES OR FOR ANY ECONOMIC CONSEQUENTIAL DAMAGES (INCLUDING LOST PROFITS OR SAVINGS), EVEN IF ASUS, ITS SUPPLIERS OR YOUR RESELLER IS INFORMED OF THEIR POSSIBILITY.

SERVICE AND SUPPORT

Visit our multi-language web site at <https://www.asus.com/support/>

Table of Contents

About this manual	5
Conventions used in this manual	6
Typography.....	6
Multi-language versions	6
Safety precautions	7
Using your LED projector.....	7
Servicing and replacement of parts	7
Caring for your LED projector	8
Proper disposal.....	8

Chapter 1: Knowing your LED projector

Features	10
Top view.....	10
Extended features	12
Flashlight	12
Emergency light mode.....	13
Front view.....	14
Rear view	15
Right side.....	17
Left side	18
Bottom view	19

Chapter 2: Setting up

Operating your LED projector	22
Connect the LED projector to the power adapter.....	22
AC power plug requirements.....	24
Connect the LED projector to your device	25
Press the power button	26
Open the lens cover and adjust the focus ring.....	27
Screen size and projection distance table.....	28

Chapter 3: Using the LED projector

Using your LED projector for the first time	30
Operating the onscreen display menu.....	31
Adjusting your LED projector's settings	32
Onscreen display menu options.....	33
Volume	33
Brightness.....	33
Contrast	34
Auto Keystone	34
Aspect Ratio.....	35
Splendid.....	35
Projection Position	36
Setup	37
Information.....	37
Turning off your LED projector.....	38

Appendices

Federal Communications Commission Statement	40
Regional notice for California.....	40
Canadian Department of Communications Statement	41
Global Environmental Regulation Compliance and Declaration ...	41
ASUS Recycling/Takeback Services	41
HDMI/MHL Connectivity	42
Supported PC Timings.....	43
HDMI (PC).....	43
HDMI (Video).....	43
Specifications for E1 LED projector.....	44

About this manual

This manual provides information about the hardware and software features of your LED projector through the following chapters:

Chapter 1: Knowing your LED Projector

This chapter details the parts of your LED projector and its accompanying remote control.

Chapter 2: Setting up

This chapter shows you how to set up your LED projector and use its parts for input device connection.

Chapter 3: Using the LED projector

This chapter describes the features of the LED projector's control panel buttons and how to use them to launch the functions of your LED projector.

Appendices

This section includes safety notices for your LED projector.

Conventions used in this manual

To highlight key information in this manual, some text are presented as follows:

IMPORTANT! This message contains vital information that must be followed to complete a task.

NOTE: This message contains additional information and tips that can help complete tasks.

WARNING! This message contains important information that must be followed to keep you safe while performing tasks and prevent damage to your LED projector's data and components.

Typography

Bold = This indicates a menu or an item that must be selected.

Italic = This indicates sections that you can refer to in this manual.

Multi-language versions

Download other language versions of this E-Manual via this website:

<https://www.asus.com/support/>

Safety precautions

Using your LED projector

- Refer to the manual and take note of the safety instructions before operating your LED projector.
- Follow the notes and warnings stated in the user manual.
- DO NOT place your LED projector on uneven or unstable surfaces.
- DO NOT use your LED projector in smoky environments. Smoke residue may cause build-up on critical parts and damage the LED projector or decrease its performance.
- DO NOT use damaged power cords, accessories, and other peripherals with your LED projector.
- Keep the LED projector's plastic packages out of the reach of children.
- DO NOT block or place anything near the LED projector's ventilation holes. Doing so may cause internal heat build-up that can degrade picture quality and damage the projector.
- Ensure that the operating voltage of your LED projector matches the voltage of your power source.

Servicing and replacement of parts

- DO NOT disassemble or attempt to service this LED projector by yourself. Contact your local ASUS service center for assistance.
- Risk of explosion if battery is replaced by an incorrect type. Dispose used batteries according to safety instructions and contact your local ASUS service center for assistance.
- When replacing parts of your LED projector, purchase items as specified by ASUS and contact your local service center for assistance.

Caring for your LED projector

- Switch off then unplug the LED projector from the power outlet before cleaning it.
- When cleaning the LED projector's housing, use a clean soft cloth dampened with water or a mix of water and neutral detergent. Wipe it dry using a soft dry cloth.
- Ensure that the lens is cool before cleaning it. Gently wipe the lens using a lens cleaning paper. **DO NOT** touch the lens with your hands.
- **DO NOT** use liquid or aerosole cleaners, benzene, or thinners on your LED projector.
- Never operate this LED projector immediately after moving it from a cold location. When the LED projector is exposed to a drastic change in temperature, moisture may condense on the lens and its other internal parts. To prevent this, use the unit two (2) hours after an extreme or sudden change in temperature occurs.

Proper disposal



DO NOT throw your LED projector in municipal waste. This product has been designed to enable proper reuse of parts and recycling. The symbol of the crossed out wheeled bin indicates that the product (electrical, electronic equipment and mercury-containing button cell battery) should not be placed in municipal waste. Check local regulations for disposal of electronic products.



DO NOT throw the battery in municipal waste. The symbol of the crossed out wheeled bin indicates that the battery should not be placed in municipal waste.

Chapter 1: Knowing your LED projector

Features

Top view

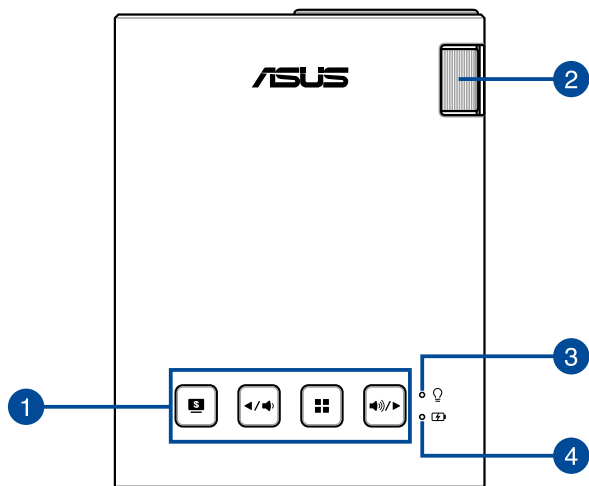

1 Control panel buttons

The control panel buttons allow you to navigate the onscreen display menu. Individually, these buttons also correspond to a specific LED projector setting as indicated below.



Splendid/Exit



Left/Volume
down



Menu/OK



Right/Volume
up

NOTE: For more information on using the control panel buttons to access your LED projector's settings, refer to *Chapter 3: Using the LED projector*.

2 Focus ring

The focus ring allows you to adjust the image focus of your LED projector.

3 Power indicator and battery status indicator

This LED indicator indicates the following scenarios for your LED projector:

- It lights up when the LED projector is powered on.
- It lights up as either green or red depending on the battery charge status.

For details on how this LED indicator functions as a battery status indicator, refer to the following table:

Color	Status
Solid Green	The LED projector is plugged to a power source, running on battery mode and the battery power is more than 25%, or running in power bank mode.
Solid Red	The LED projector is running on battery mode only and the battery power is not more than 25%.
Blinking Red and Green	The temperature of the LED projector is too high and will lower its brightness automatically. The LED projector will shut down if the temperature is still too high to prevent overheating.

4 Battery charge indicator

This LED indicator lights up when the LED projector is plugged to a power source using its power adapter.

IMPORTANT! Use only the bundled power adapter to charge the battery pack and supply power to your LED projector.

Extended features

Your LED projector also have stand-alone features that are launched by pressing the **Splendid/Exit** button while your LED projector is on battery mode.

NOTE:

- These feature are only available when no power adapter or signal is connected to the LED projector.
- To turn off or switch between the flashlight and emergency light feature of your LED projector, just press the **Splendid/Exit** button until your preferred lighting feature is disabled or enabled.

IMPORTANT! Ensure that your LED projector is charged and can run on battery mode before enabling these features. Battery time varies depending on usage.

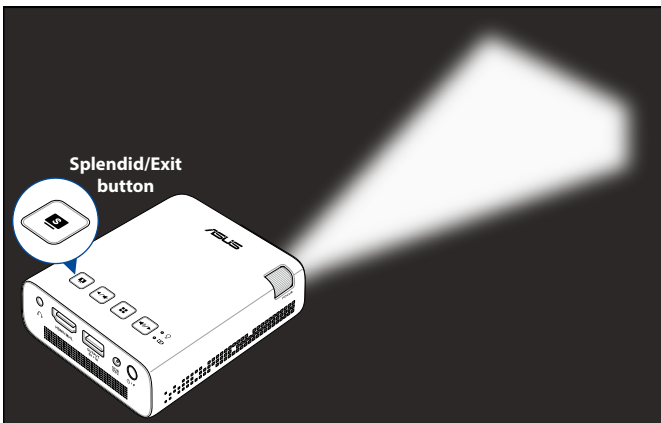

Flashlight

The LED projector flashes a steady white light when you use this feature.



To use your LED projector as a flashlight:

1. Disconnect all peripherals from your LED projector then press the power button to turn it on.



2. Open the cover of your LED projector's lens.
3. Press  on the control panel of your LED projector to launch the **NO SIGNAL** display.
4. Press  repeatedly until the LED projector flashes a steady white light.

Emergency light mode

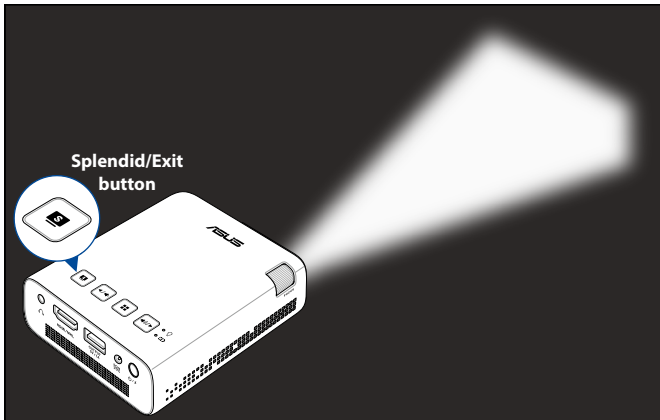
The LED projector flashes a blinking white light when you use this feature.



To use your LED projector as an emergency light:

1. Disconnect all peripherals from your LED projector then press the power button to turn it on.
2. Open the cover of your LED projector's lens.
3. Press  on the control panel of your LED projector to launch the **NO SIGNAL** display.
4. Press  repeatedly until the LED projector flashes a blinking white light.

Front view

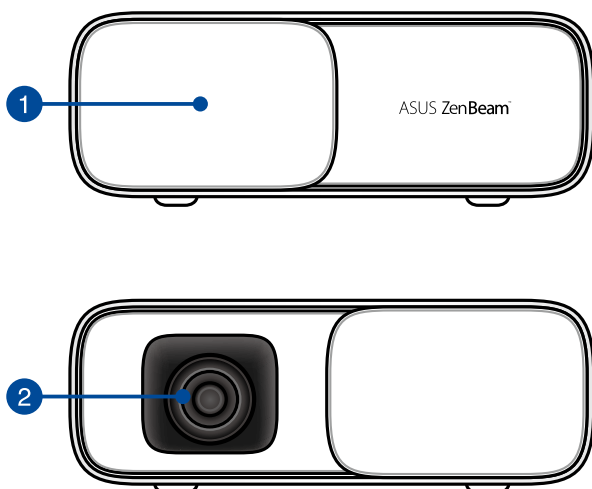

1 Lens cover

The lens cover protects the lens from scratches and possible dirt build-up.

IMPORTANT! Remove the lens cover before using your LED projector.

2 Lens

The lens projects video or image files onscreen from your input device.

WARNING!

- DO NOT touch the lens with your hands or any sharp object.
 - DO NOT look directly into the lens.
-

Rear view

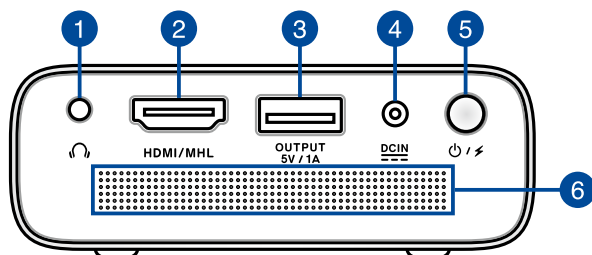

1 Audio output jack port

The audio output jack port allows you to connect your LED projector to amplified speakers or headphones.

2 HDMI/MHL port

This port is for the HDMI (High-Definition Multimedia Interface) connector and also supports MHL (Mobile High-Definition Link) compatible devices. This port is HDCP compliant for HD DVD, Blu-ray, and other protected content playback.

3 Power output port

This power output port provides up to 5V/1A of output voltage and current. You can connect your mobile device to this port to keep it charged while using it with your LED projector.

4 Power (DC) input port

Insert the bundled power adapter into this port to charge the battery pack and supply power to your LED projector.

IMPORTANT! Use only the bundled power adapter to charge the battery pack and supply power to your LED projector.

WARNING! The adapter may become warm to hot while in use. DO NOT cover the adapter and keep it away from your body while it is connected to a power source.

5 Power button

Long press this power button to turn on or turn off your LED projector.
Short press this button to turn on or turn off power bank mode.

6 Air vents

The air vents allow cool air to enter and warm air to exit the LED projector.

WARNING! Ensure that paper, books, clothing, cables, or other objects do not block any of the air vents or else overheating may occur.

Right side

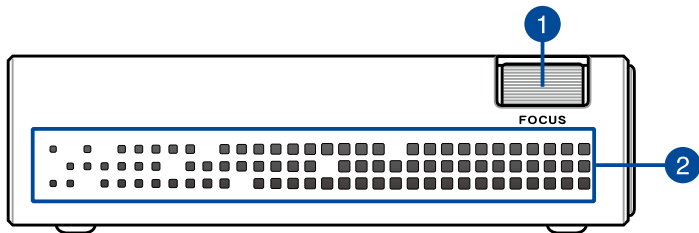

1 Focus ring

The focus ring allows you to adjust the image focus of your LED projector.

2 Air vents

The air vents allow cool air to enter and warm air to exit the LED projector.

WARNING! Ensure that paper, books, clothing, cables, or other objects do not block any of the air vents or else overheating may occur.

Left side

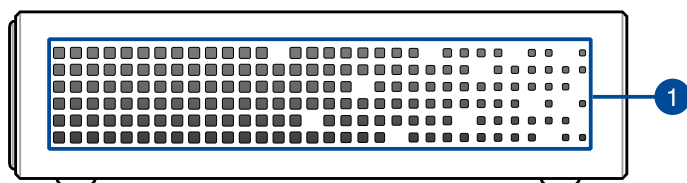

1 Air vents

The air vents allow cool air to enter and warm air to exit the LED projector.

WARNING! Ensure that paper, books, clothing, cables, or other objects do not block any of the air vents or else overheating may occur.

Bottom view

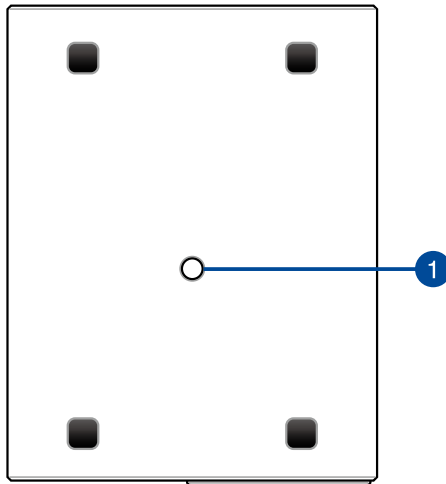

1 Tripod socket

Attach the LED projector to a tripod using this socket.

Chapter 2: Setting up

Operating your LED projector

This portable LED projector allows you to plug and play your devices so you can easily open multimedia files and hear audio straight from its built-in SonicMaster speakers.

For your safety and to maintain the quality of this unit, refer to the following steps when operating your LED projector.

Connect the LED projector to the power adapter

- A. Insert the plug head into the AC power adapter.
- B. Plug the AC power adapter into a 100V~240V power source.
- C. Connect the DC power connector into your LED projector.



Charge the LED projector for **3 hours** before using it in battery mode for the first time.

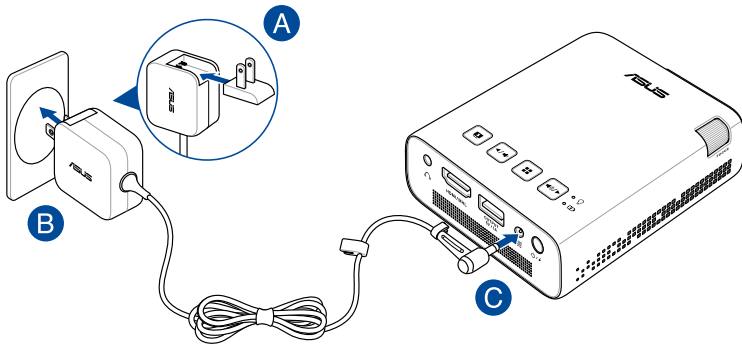

NOTE: The power adapter may vary in appearance, depending on models and your region.

IMPORTANT!

- Use only the bundled power adapter to charge the battery pack and supply power to your LED projector.
 - Ensure that your LED projector is connected to the power adapter before turning it on for the first time. We strongly recommend that you use a grounded wall socket while using your LED projector on power adapter mode.
 - The socket outlet must be easily accessible and near your LED projector.
 - To disconnect your LED projector from its main power supply, unplug your LED projector from the power socket.
-

WARNING!

Read the following precautions for your LED projector's battery:

- The battery capacity will vary depending on the environment temperature, humidity, and LED Projector usage.
 - The battery used in this device may present a risk of fire or chemical burn if removed or disassembled.
 - Follow the warning labels for your personal safety.
 - Risk of explosion if battery is replaced by an incorrect type.
 - DO NOT dispose of in fire.
 - Never attempt to short-circuit your LED projector's battery.
 - Never attempt to disassemble and reassemble the battery.
 - Discontinue usage if leakage is found.
 - The battery and its components must be recycled or disposed of properly.
 - Keep the battery and other small components away from children.
-

AC power plug requirements

Use the correct AC power plug type according to your current location.

IMPORTANT! Contact your sales dealer if the AC power plug bundled with your LED projector does not match your local power source.

NOTE: We highly recommend that you use a video source device that also uses a grounding type plug to prevent signal interference due to voltage fluctuations.



for Australia and Mainland China

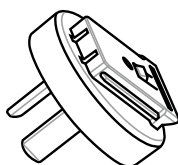

for Argentina

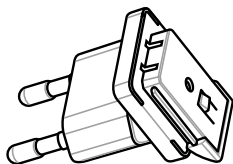

for Korea

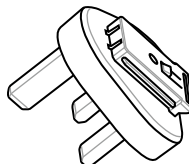

for U.K.

Connect the LED projector to your device

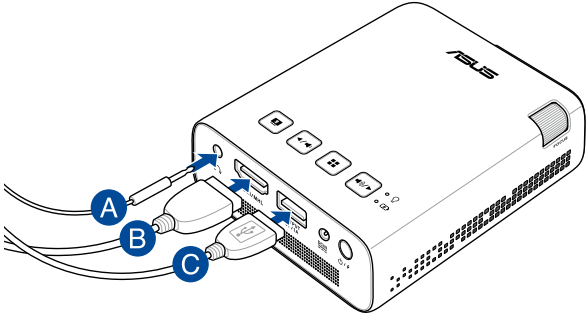

A Audio output

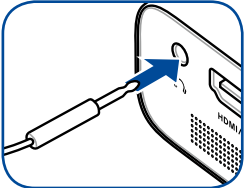

B HDMI/MHL

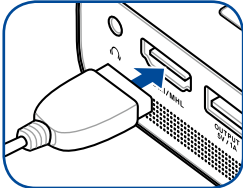

C Power output (5V/1A)

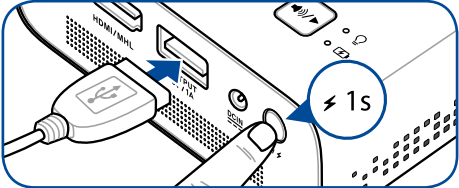

Press the power button

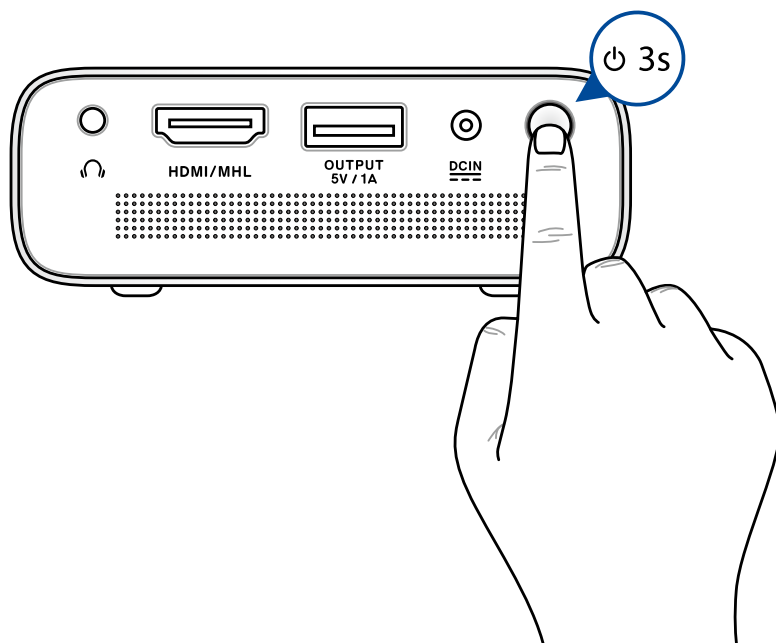

NOTE: The battery pack inside your LED projector stops charging while the LED projector is in use. Refer to the battery indicator for the current charge status of your LED projector. You may also refer to the *Top View* section in this manual for more details.

Open the lens cover and adjust the focus ring

NOTE: Use a still image when adjusting the onscreen display.

- A. Open the lens cover by moving it to the right.
- B. Adjust the image focus of the projection onscreen by moving the focus ring up or down.

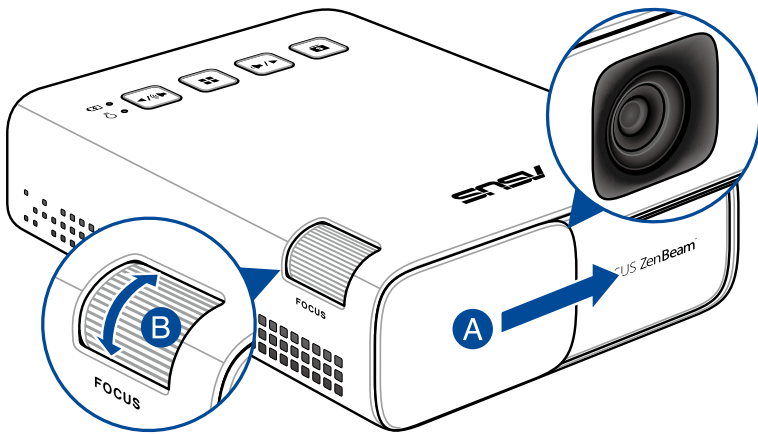

Screen size and projection distance table

Adjust the LED projector's distance from the screen using the table below.



Screen size - 16:9		Projection distance (meters)
(inches)	(millimeters)	
15.5	394	0.5
31	787	1.0
100	2540	3.1
120	3048	3.2

Chapter 3: Using the LED projector



Using your LED projector for the first time

Refer to the following steps when using your LED projector for the first time.

NOTE: Ensure that your LED projector is connected to the power adapter before turning it on for the first time. We strongly recommend that you use a grounded wall socket while using your LED projector on power adapter mode.

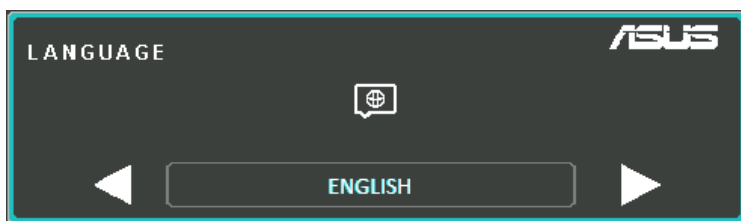
1. Set up your LED projector then press the power button.
2. Press  or  on your LED projector's control panel to browse through the available language options.



3. After you have chosen your preferred language, press  to set this language for use on your LED projector.
4. You may now start using your LED projector to display files from your input device. The **NO SIGNAL** screen may appear if no input device is connected or cannot be detected by the LED projector.
5. Press  on your LED projector's control panel to launch its onscreen display menu.

Operating the onscreen display menu

Your LED projector is a plug-and-play device that also features an onscreen display menu that contains a set of programs and settings that can maximize your use of the LED projector.

Launch the onscreen display menu by pressing  on the control panel of your LED projector.

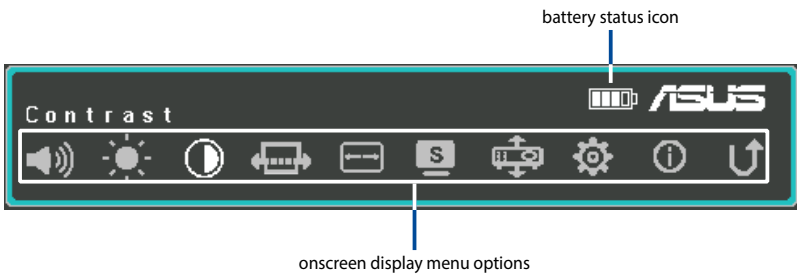



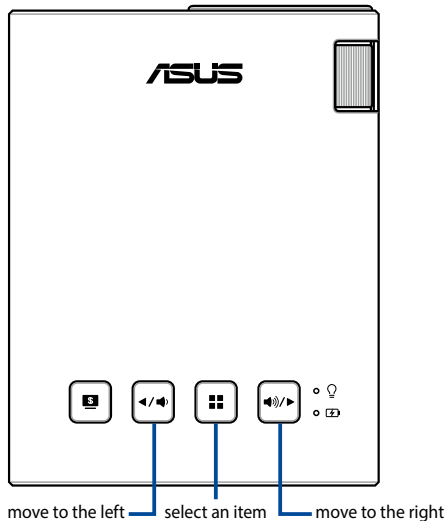



To navigate the onscreen display menu, press the following buttons on your LED projector's control panel:



Adjusting your LED projector's settings

Refer to the following steps when accessing the onscreen display menu options to adjust your LED projector settings:



1. Launch the onscreen display menu.
2. Press  or  to select the menu option you would like to access.
3. Press  to open the selected option's settings.
4. Press  or  to adjust the settings according to your preference.
5. When finished, press  to save the new settings and go back to the home screen.

You may refer to the following pages for details on each of the onscreen display menu options.

Onscreen display menu options

Volume

Select this menu option to adjust the volume of the audio file played on your LED projector.

You may adjust the volume on a scale of **0** to **10**, from mute to the loudest possible volume played via your LED projector's built-in speakers. Press and hold  or  to quickly mute or adjust the volume to the loudest.

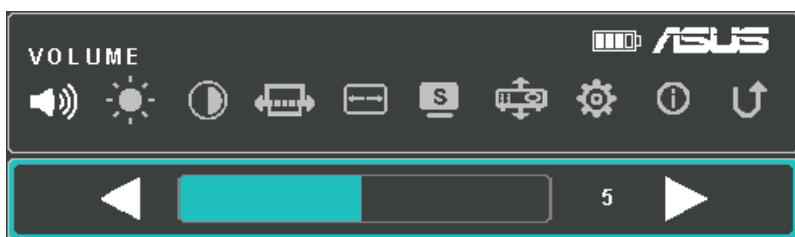

Brightness

Select this menu option to adjust the brightness of your projection onscreen.

You may adjust the brightness on a scale of **0** to **10**, from darkest to brightest.

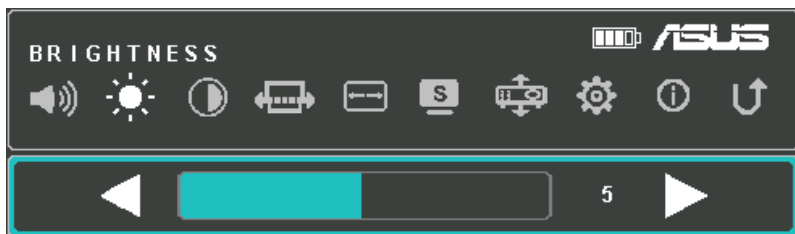

Contrast

Select this menu option to adjust the light and dark areas of your projection onscreen.

You may adjust the contrast on a scale of **0** to **10**, from the lowest to the highest possible color contrast.

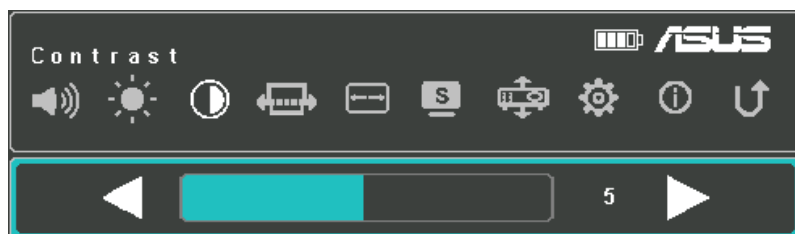

Auto Keystone

Select this menu option to automatically adjust the alignment of your image.

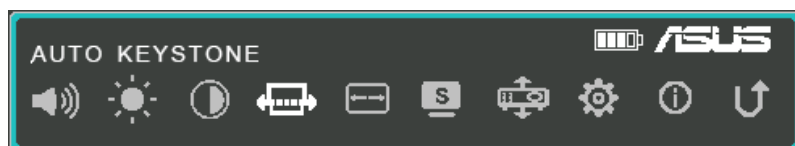

Aspect Ratio

Select this menu option to adjust the screen ratio of your projection onscreen.

You may change the projection of your display according to the following aspect ratios: **AUTO**, **4:3**, and **16:9**.



Splendid

Select this menu option to activate either of the following display modes, depending on how the LED projector is powered on. You may also directly launch this menu option by pressing .

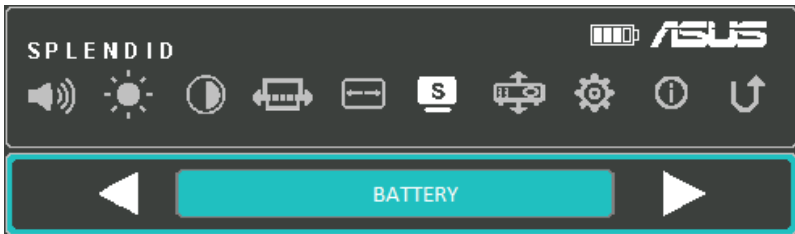

Refer to the following information for details on the different modes you can activate via **Splendid**:

- **PRESENTATION MODE** - This mode allows you to optimize the brightness of your LED projector and is suitable for quick presentations of up to ninety (90) minutes.
- **STANDARD** - This mode fits general display uses of the LED projector.

- **THEATER** - This mode is recommended when using the LED projector to display videos.
- **ECO** - This mode allows the LED projector to run under minimum power consumption for up to five (5) hours.

NOTE:

- You may also launch the following modes by directly pressing the **Splendid/Exit** button after turning on your LED projector.
 - Flashlight and Emergency light mode are only available when no power adapter or signal is connected to the LED projector.
 - The battery capacity will vary depending on the environment temperature, humidity, and LED Projector usage.
-

Projection Position

This option allows you to change the way your projections are oriented onscreen based from the current location of your LED projector.

You may change your projection's orientation to correspond with the location where your LED projector is currently placed: **FRONT TABLE, REAR TABLE**.



Setup

Select this menu option to configure the following settings of your LED projector:

- **LANGUAGE** - This option allows you to set the LED projector's onscreen display menu to other languages.
- **RESET ALL SETTINGS** - This option restores all the default settings of your LED projector.

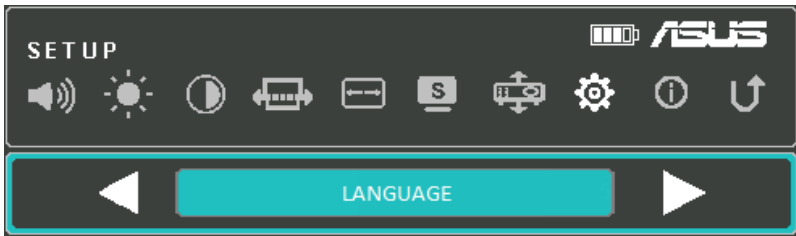

Information

Select this menu option to see an overview of information about your LED projector.

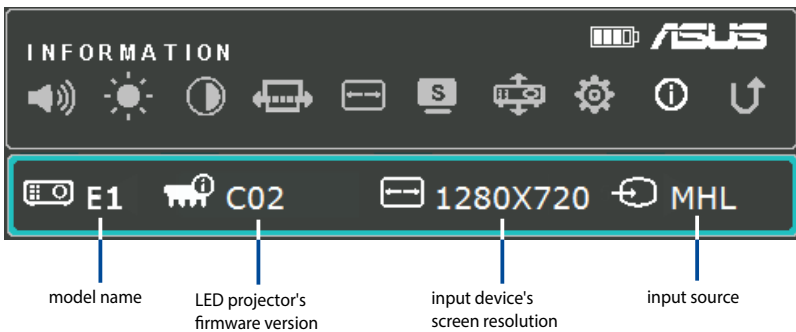

Turning off your LED projector

1. Press the power button.

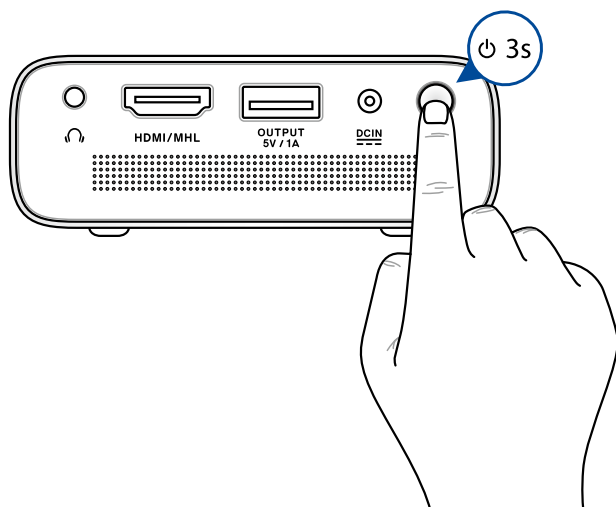

2. When the following screen appears, press the power button again to completely turn off your LED projector.

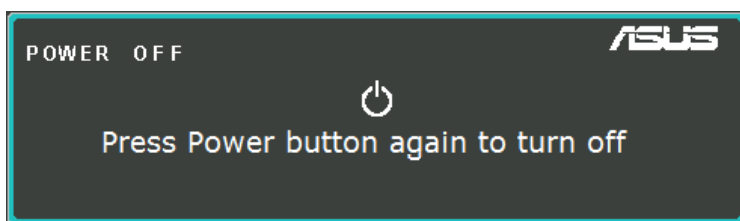

NOTE: For safety purposes, charging the battery of your LED projector may not immediately start after the device is powered off. Once the projector cools off, charging its battery automatically begins.

Appendices

Federal Communications Commission Statement

This equipment has been tested and found to comply with the limits for a class B digital device, pursuant to Part 15 of the Federal Communications Commission (FCC) rules. These limits are designed to provide reasonable protection against harmful interference in a residential installation. This equipment generates, uses, and can radiate radio frequency energy and, if not installed and used in accordance with the instructions, may cause harmful interference to radio communications. However, there is no guarantee that interference will not occur in a particular installation. If this equipment does cause harmful interference to radio or television reception, which can be determined by turning the equipment off and on, the user is encouraged to try to correct the interference by one or more of the following measures:

- Reorient or relocate the receiving antenna.
- Increase the distance between the equipment and receiver.
- Connect the equipment to an outlet on a different circuit than that which the receiver is connected to.
- Consult the dealer or an experienced radio/TV technician for help.

This device complies with Part 15 of the FCC Rules. Operation is subject to the following two conditions:

1. This device may not cause harmful interference, and
2. This device must accept any interference that may cause undesired operation.

Regional notice for California

This product contains chemicals, including lead, known to the State of California to cause birth defects or other reproductive harm. Wash hands after handling.

Canadian Department of Communications Statement

This digital apparatus does not exceed the Class B limits for radio noise emissions from digital apparatus set out in the Radio Interference Regulations of the Canadian Department of Communications.

This class B digital apparatus complies with Canadian ICES-003.

Global Environmental Regulation Compliance and Declaration

ASUS follows the green design concept to design and manufacture our products, and makes sure that each stage of the product life cycle of ASUS product is in line with global environmental regulations. In addition, ASUS disclose the relevant information based on regulation requirements.

Please refer to <http://csr.asus.com/english/Compliance.htm> for information disclosure based on regulation requirements ASUS is complied with:

Japan JIS-C-0950 Material Declarations

EU REACH SVHC

Korea RoHS

ASUS Recycling/Takeback Services

ASUS recycling and takeback programs come from our commitment to the highest standards for protecting our environment. We believe in providing solutions for you to be able to responsibly recycle our products, batteries, other components as well as the packaging materials. Please go to <http://csr.asus.com/english/Takeback.htm> for detailed recycling information in different regions.

HDMI/MHL Connectivity

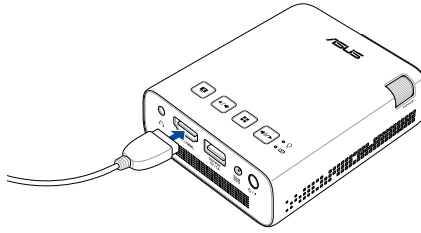
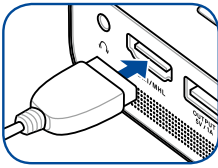

	<p>Devices with HDMI port</p>	<ul style="list-style-type: none"> • HDMI to HDMI Cable
	<p>Devices with micro HDMI port</p>	<ul style="list-style-type: none"> • Micro HDMI to HDMI Adapter • HDMI to HDMI Cable
	<p>Devices with standard 5-pin MHL port</p>	<ul style="list-style-type: none"> • Micro USB to HDMI MHL Cable
	<p>Devices with 11-pin micro USB port (such as Samsung Galaxy S3, S4, S5, and Note 4)</p>	<ul style="list-style-type: none"> • 5-Pin to 11-Pin Micro USB Adapter • Micro USB to HDMI MHL Cable
	<p>iOS devices with 30-pin port</p>	<ul style="list-style-type: none"> • 30-Pin Digital AV Adapter • HDMI to HDMI Cable
	<p>iOS devices with Lightning™ port</p>	<ul style="list-style-type: none"> • Lightning™ Digital AV Adapter • HDMI to HDMI Cable

Supported PC Timings

HDMI (PC)

Resolution	Mode	Refresh rate (Hz)	H-frequency (kHz)	Clock (MHz)
800 x 600	SVGA_60	60.317	37.879	40
1024 x 768	XGA_60	60.004	48.363	65
1280 x 720	1280 x 720_60	60	45	74.25
1280 x 800	1280 x 800_60	59.81	49.702	83.5
1280 x 960	1280 x 960_60	60	60	108
1280 x 1024	1280 x 1024_60	60.02	63.98	108
1366 x 768	1366 x 768_60	60	47.712	85.5
1440 x 900	1440 x 900_60	60	55.9	106.5
1680 x 1050	1680 x 1050_60	60	65.3	146.25
1400 x 1050	1400 x 1050_60	60	65.3	121.75
1600 x 1200	1600 x 1200_60	60	75	162
1920 x 1080	1920 x 1080_60	60	67.5	148.5

HDMI (Video)

Timing	Resolution	Vertical frequency (Hz)	H-frequency (kHz)	Dot Clock Frequency (MHz)
480i	720 (1440) x 480	59.94	15.73	27
480p	720 x 480	59.94	31.47	27
576i	720 (1440) x 576	50	15.63	27
576p	720 x 576	50	31.25	27
720/50p	1280 x 720	50	37.5	74.25
720/60p	1280 x 720	60	45	74.25
1080/50i	1920 x 1080	50	28.13	74.25
1080/60i	1920 x 1080	60	33.75	74.25
1080/50P	1920 x 1080	50	56.25	148.5
1080/60P	1920 x 1080	60	67.5	148.5

Specifications for E1 LED projector

Display	Display Technology	0.2" DLP®
	Light Source	R/G/B LED
	Light Source Life	30,000 hrs
	True Resolution (native)	WVGA 854 x 480
	Light Output	150 Lumens
	Contrast Ratio (typical)	800:1
	Color Saturation (NTSC)	100%
	Display Colors	16.7 million colors
Projection Lens	Throw Ratio	1.4 (31 in. @ 1 m @ 16:9)
	Projection Distance	0.5 m to 3.2 m
	Projection/Screen Size	15.5 in. to 120 in.
	Projection Offset	100%
	Zoom Ratio	Fixed
Video Features	Picture Modes	Presentation, Standard, Theater, Eco, Flashlight, Emergency light
	Aspect Ratio	Auto / 4:3 / 16:9
	Auto Keystone	Yes, ±40°
	Projector Placement	Front Table, Rear Table
Audio Features	Built-in speakers	2W speaker (ASUS SonicMaster Audio technology)

(continued on the next page)

Signal Frequency	Digital Signal Frequency	24.7 KHz(H) to 74.6 KHz(H) / 50 Hz(V) to 60 Hz(V)
Power	Power On Mode	≤24W
	Standby Mode	<0.5W
Battery	Internal Battery	6000mAh (5V@1A)
	Battery Life	22Wh (up to 5 hours)
Noise	Acoustic Noise	30 dB (Standard mode)
		28 dB (Theater mode)
Input / Output	PC Signal Input	HDMI 1.3 (HDCP support)/ MHL
	Audio Out	Earphone out
	USB 2.0 port for power output	Yes (5V@1A)
Mechanical Design	Chassis Colors	Silver
	Tripod Socket	Yes
	On-machine Buttons	Yes
	Lens Cover	Yes
Dimension	Physical Dimension	83 mm x 110 mm x 29 mm (L x W x H)
Weight	Net Weight (Esti.)	310 g

(continued on the next page)

Operating Temperature	0° C to 40° C
Operating Humidity	20% to 90%
Accessories	Carry Bag, Power Adapter, AC Plug, HDMI Cable, Quick Start Guide, Warranty Card
Regulation Approvals	FCC / CE / CB / CCC / RCM / VCCI / CU / IEC62471 / CEC

NOTE:

- Specifications are subject to change without prior notice.
 - Product availability may vary by region.
 - All brand and product names mentioned are trademarks of their respective companies.
-