

ASUS®

MG28U Series LCD Monitor

User Guide

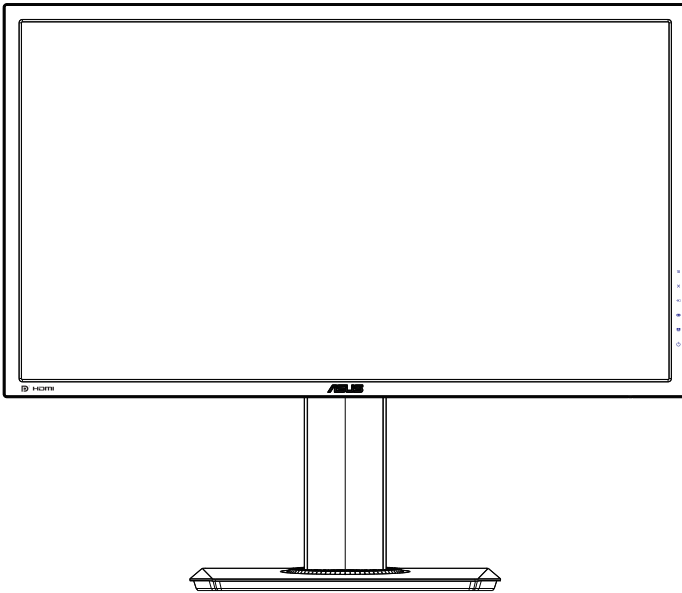

HDMI™
HIGH-DEFINITION MULTIMEDIA INTERFACE

Table of contents

| | |
|--|------|
| Notices | iii |
| Safety information | v |
| Care & Cleaning | vii |
| 1.1 Welcome! | 1-1 |
| 1.2 Package contents..... | 1-1 |
| 1.3 Assembling the monitor | 1-2 |
| 1.4 Connect cables..... | 1-3 |
| 1.4.1 Rear of the LCD monitor | 1-3 |
| 1.5 Monitor introduction | 1-4 |
| 1.5.1 Using the Controls button | 1-4 |
| 2.1 Detaching the Quick Release stand (for VESA wall mount) | 2-1 |
| 2.2 Adjusting the monitor | 2-2 |
| 3.1 OSD (On-Screen Display) menu | 3-1 |
| 3.1.1 How to reconfigure | 3-1 |
| 3.1.2 OSD Function Introduction..... | 3-2 |
| 3.2 Specifications..... | 3-9 |
| 3.3 Troubleshooting (FAQ)..... | 3-10 |
| 3.4 Supported Timing List..... | 3-12 |

Copyright © 2015 ASUSTeK COMPUTER INC. All Rights Reserved.

No part of this manual, including the products and software described in it, may be reproduced, transmitted, transcribed, stored in a retrieval system, or translated into any language in any form or by any means, except documentation kept by the purchaser for backup purposes, without the express written permission of ASUSTeK COMPUTER INC. ("ASUS").

Product warranty or service will not be extended if: (1) the product is repaired, modified or altered, unless such repair, modification or alteration is authorized in writing by ASUS; or (2) the serial number of the product is defaced or missing.

ASUS PROVIDES THIS MANUAL "AS IS" WITHOUT WARRANTY OF ANY KIND, EITHER EXPRESS OR IMPLIED, INCLUDING BUT NOT LIMITED TO THE IMPLIED WARRANTIES OR CONDITIONS OF MERCHANTABILITY OR FITNESS FOR A PARTICULAR PURPOSE. IN NO EVENT SHALL ASUS, ITS DIRECTORS, OFFICERS, EMPLOYEES OR AGENTS BE LIABLE FOR ANY INDIRECT, SPECIAL, INCIDENTAL, OR CONSEQUENTIAL DAMAGES (INCLUDING DAMAGES FOR LOSS OF PROFITS, LOSS OF BUSINESS, LOSS OF USE OR DATA, INTERRUPTION OF BUSINESS AND THE LIKE), EVEN IF ASUS HAS BEEN ADVISED OF THE POSSIBILITY OF SUCH DAMAGES ARISING FROM ANY DEFECT OR ERROR IN THIS MANUAL OR PRODUCT.

SPECIFICATIONS AND INFORMATION CONTAINED IN THIS MANUAL ARE FURNISHED FOR INFORMATIONAL USE ONLY, AND ARE SUBJECT TO CHANGE AT ANY TIME WITHOUT NOTICE, AND SHOULD NOT BE CONSTRUED AS A COMMITMENT BY ASUS. ASUS ASSUMES NO RESPONSIBILITY OR LIABILITY FOR ANY ERRORS OR INACCURACIES THAT MAY APPEAR IN THIS MANUAL, INCLUDING THE PRODUCTS AND SOFTWARE DESCRIBED IN IT.

Products and corporate names appearing in this manual may or may not be registered trademarks or copyrights of their respective companies, and are used only for identification or explanation and to the owners' benefit, without intent to infringe.

Notices

Federal Communications Commission Statement

This device complies with Part 15 of the FCC Rules. Operation is subject to the following two conditions:

- This device may not cause harmful interference, and
- This device must accept any interference received including interference that may cause undesired operation.

This equipment has been tested and found to comply with the limits for a Class B digital device, pursuant to Part 15 of the FCC Rules. These limits are designed to provide reasonable protection against harmful interference in a residential installation. This equipment generates, uses and can radiate radio frequency energy and, if not installed and used in accordance with manufacturer's instructions, may cause harmful interference to radio communications. However, there is no guarantee that interference will not occur in a particular installation. If this equipment does cause harmful interference to radio or television reception, which can be determined by turning the equipment off and on, the user is encouraged to try to correct the interference by one or more of the following measures:

- Reorient or relocate the receiving antenna.
- Increase the separation between the equipment and receiver.
- Connect the equipment to an outlet on a circuit different from that to which the receiver is connected.
- Consult the dealer or an experienced radio/TV technician for help.



As an Energy Star® Partner, our company has determined that this product meets the Energy Star® guidelines for energy efficiency.

Canadian Department of Communications Statement

This digital apparatus does not exceed the Class B limits for radio noise emissions from digital apparatus set out in the Radio Interference Regulations of the Canadian Department of Communications.

This class B digital apparatus complies with Canadian ICES-003.

Made In China

TCO Information

Congratulations!

This display is designed for both you and the planet!



The display you have just purchased carries the TCO Certified label. This ensures that your display is designed, manufactured and tested according to some of the strictest quality and environmental requirements in the world. This makes for a high performance product, designed with the user in focus that also minimizes the impact on the climate and our natural environment.

TCO Certified is a third party verified program, where every product model is tested by an accredited impartial test laboratory. TCO Certified represents one of the toughest certifications for displays worldwide.

Some of the Usability features of the TCO Certified for displays:

- Good visual ergonomics and image quality is tested to ensure top performance and reduce sight and strain problems. Important parameters are luminance, contrast, resolution, black level, gamma curve, color and luminance uniformity, color rendition and image stability.
- Product have been tested according to rigorous safety standards at an impartial laboratory.
- Electric and magnetic fields emissions as low as normal household background levels.
- Low acoustic noise emissions.

Some of the Environmental features of the TCO Certified for displays:

- The brand owner demonstrates corporate social responsibility and has a certified environmental management system (EMAS or ISO 14001).
- Very low energy consumption both in on- and standby mode minimize climate impact.
- Restrictions on chlorinated and brominated flame retardants, plasticizers, plastics and heavy metals such as cadmium, mercury and lead (RoHS compliance).
- Both product and product packaging is prepared for recycling.
- The brand owner offers take-back options.

The requirements can be downloaded from our web site. The requirements included in this label have been developed by TCO Development in co-operation with scientists, experts, users as well as manufacturers all over the world. Since the end of the 1980s TCO has been involved in influencing the development of IT equipment in a more user-friendly direction. Our labeling system started with displays in 1992 and is now requested by users and IT manufacturers all over the world. About 50% of all displays worldwide are TCO certified.

For displays with glossy bezels the user should consider the placement of the display as the bezel may cause disturbing reflections from surrounding light and bright surfaces

For more information, please visit
www.tcodevelopment.com

Safety information

- Before setting up the monitor, carefully read all the documentation that came with the package.
- To prevent fire or shock hazard, never expose the monitor to rain or moisture.
- Never try to open the monitor cabinet. The dangerous high voltages inside the monitor may result in serious physical injury.
- If the power supply is broken, do not try to fix it by yourself. Contact a qualified service technician or your retailer.
- Before using the product, make sure all cables are correctly connected and the power cables are not damaged. If you detect any damage, contact your dealer immediately.
- Slots and openings on the back or top of the cabinet are provided for ventilation. Do not block these slots. Never place this product near or over a radiator or heat source unless proper ventilation is provided.
- The monitor should be operated only from the type of power source indicated on the label. If you are not sure of the type of power supply to your home, consult your dealer or local power company.
- Use the appropriate power plug which complies with your local power standard.
- Do not overload power strips and extension cords. Overloading can result in fire or electric shock.
- Avoid dust, humidity, and temperature extremes. Do not place the monitor in any area where it may become wet. Place the monitor on a stable surface.
- Unplug the unit during a lightning storm or if it will not be used for a long period of time. This will protect the monitor from damage due to power surges.
- Never push objects or spill liquid of any kind into the slots on the monitor cabinet.
- To ensure satisfactory operation, use the monitor only with UL listed computers which have appropriate configured receptacles marked between 100 ~ 240V AC.
- The socket-outlet shall be installed near the equipment and shall be easily accessible
- If you encounter technical problems with the monitor, contact a qualified service technician or your retailer.
- Provide an earthing connection before the mains plug is connected to the mains. And, when disconnecting the earthing connection, be sure to disconnect after pulling out the mains plug from the mains.

WARNING

Usage of other than specified head- or earphones can result in hearing loss due to excessive sound pressures.

Care & Cleaning

- Before you lift or reposition your monitor, it is better to disconnect the cables and power cord. Follow the correct lifting techniques when positioning the monitor. When lifting or carrying the monitor, grasp the edges of the monitor. Do not lift the display by the stand or the cord.
- Cleaning. Turn your monitor off and unplug the power cord. Clean the monitor surface with a lint-free, non-abrasive cloth. Stubborn stains may be removed with a cloth dampened with mild cleaner.
- Avoid using a cleaner containing alcohol or acetone. Use a cleaner intended for use with the LCD. Never spray cleaner directly on the screen, as it may drip inside the monitor and cause an electric shock.

The following symptoms are normal with the monitor:

- The screen may flicker during the initial use due to the nature of the fluorescent light. Turn off the Power Switch and turn it on again to make sure that the flicker disappears.
- You may find slightly uneven brightness on the screen depending on the desktop pattern you use.
- When the same image is displayed for hours, an afterimage of the previous screen may remain after switching the image. The screen will recover slowly or you can turn off the Power Switch for hours.
- When the screen becomes black or flashes, or cannot work anymore, contact your dealer or service center to fix it. Do not repair the screen by yourself!

Conventions used in this guide



WARNING: Information to prevent injury to yourself when trying to complete a task.



CAUTION: Information to prevent damage to the components when trying to complete a task.



IMPORTANT: Information that you **MUST** follow to complete a task.



NOTE: Tips and additional information to aid in completing a task.

Where to find more information

Refer to the following sources for additional information and for product and software updates.

1. ASUS websites

The ASUS websites worldwide provide updated information on ASUS hardware and software products. Refer to **<http://www.asus.com>**

2. Optional documentation

Your product package may include optional documentation that may have been added by your dealer. These documents are not part of the standard package.

1.1 Welcome!

Thank you for purchasing the ASUS® LCD monitor!

The latest widescreen LCD monitor from ASUS provides a crisper, broader, and brighter display, plus a host of features that enhance your viewing experience.

With these features, you can enjoy the convenience and delightful visual experience that the monitor brings you!

1.2 Package contents

Check your package for the following items:

- ✓ LCD Monitor
- ✓ Monitor Base
- ✓ Quick Start Guide
- ✓ Warranty Card
- ✓ 1x Power Cord
- ✓ CD Manual
- ✓ 1x USB Cable
- ✓ 1x DisplayPort Cable
- ✓ 1x HDMI Cable



-
- If any of the above items is damaged or missing, contact your retailer immediately.
-

1.3 Assembling the monitor

To assemble the monitor:

1. Place the display flat on a cloth on the table, assemble the base according to the drawing and use a coin to turn the screw tight.
2. Put the cable clip inset the hole of stand, and adjust the monitor to the angle that is most comfortable for you.

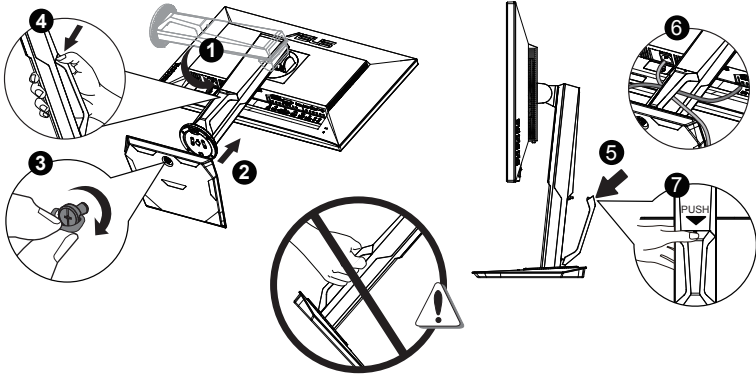

1.4 Connect cables

1.4.1 Rear of the LCD monitor

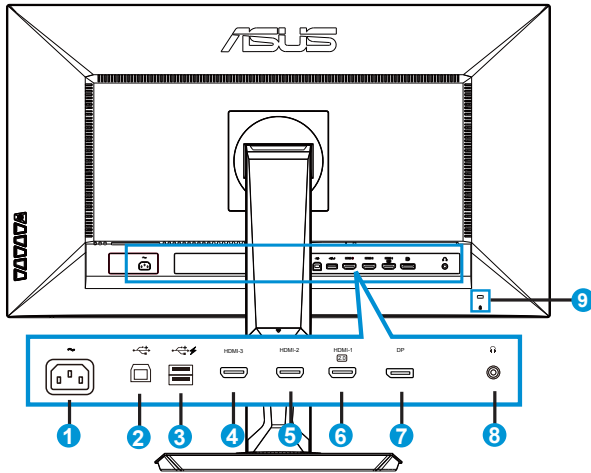

1. AC-IN Port
2. USB upstream Port
3. USB downstream Port
4. HDMI-3
5. HDMI-2
6. HDMI-1 (4K@60Hz)
7. DisplayPort
8. Earphone Jack
9. Kensington Lock

1.5 Monitor introduction

1.5.1 Using the Controls button

Use the control button on the back of the monitor to adjust the image settings.

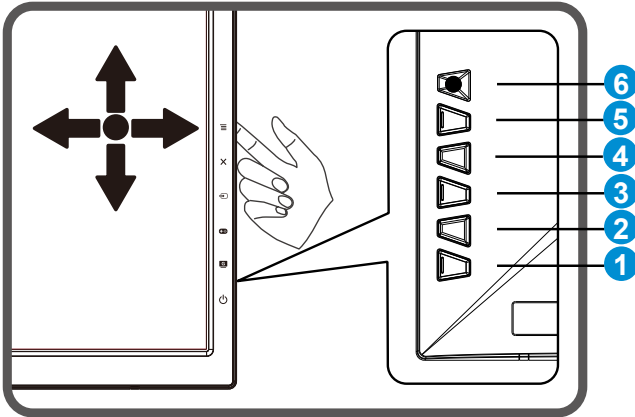

1.  Power Button/Power Indicator:



- Press this button to turn the monitor on/off.
- The color definition of the power indicator is as the below table.



| Status | Description |
|--------|--------------|
| White | ON |
| Amber | Standby mode |
| OFF | OFF |

2.  GameVisual:

- Press this hotkey to switch from seven video preset modes (Scenery Mode, Racing Mode, Cinema Mode, RTS/RPG Mode, FPS Mode, sRGB and User Mode) with GameVisual™ Video Intelligence Technology.

3.  GamePlus:

- Activate Crosshair, Timer, FPS Counter or Display Alignment function.
- Move the  (☒) button up/down to select and press  (☒) to confirm the function needed.

4.  Input Select Button:
 - Use this hotkey to switch from HDMI-1(4K@60Hz), HDMI-2, HDMI-3 or DisplayPort input signal.
 - Switch to DP 1.1 or DP 1.2.
5.  Close Button
 - Exit the OSD menu.
6.  (5-way) Button:
 - Turns on the OSD menu. Enacts the selected OSD menu item.
 - Increases/Decreases values or moves your selection up/down/left/right.

2.1 Detaching the Quick Release stand (for VESA wall mount)

The Quick Release Stand of this monitor is specially designed for VESA wall mount.

To detach the Quick Release stand

1. Disconnect power and signal cables. Carefully put the front of the monitor face down on a clean table.
2. Use a screwdriver to remove the four screws on the arm (Figure 1), and then detach the arm/stand from the monitor (Figure 2).



- We recommend that you cover the table surface with soft cloth to prevent damage to the monitor.
- Hold the stand of the monitor while removing the screws.

Figure 1

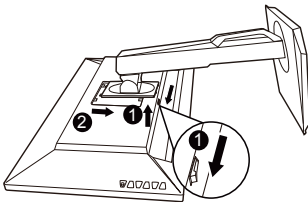
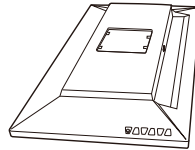

Figure 2



- The VESA wall mount kit (100 x 100 mm) is purchased separately.
- Use only the UL Listed Wall Mount Bracket with minimum weight/load 28.8 kg (Screw size: M4 x 10 mm).

2.2 Adjusting the monitor

- For optimal viewing, we recommend that you look at the full face of the monitor, then adjust the monitor to the angle that is most comfortable for you.
- Hold the stand to prevent the monitor from falling when you change its angle.
- You can adjust the monitor's angle from $+20^\circ$ to -5° and it allows 60° swivel adjustment from either left or right. You can also adjust the monitor's height within $\pm 15\text{cm}$.

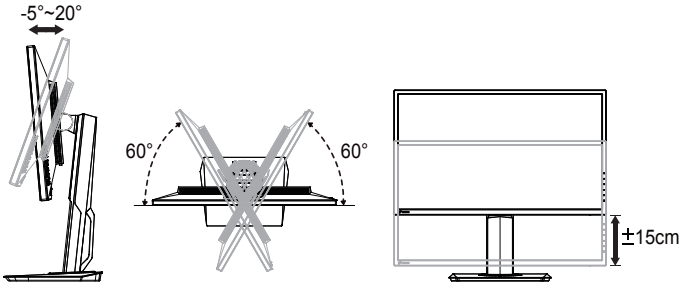

Pivoting the monitor

1. Lift the monitor to the highest position.
2. Tilt the monitor to its maximum angle.
3. Pivot the monitor clockwise to the angle you need.

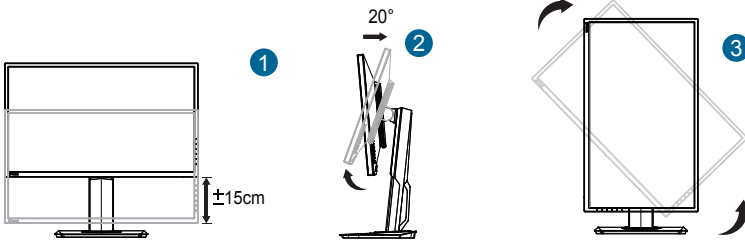

It is normal that the monitor slightly shakes while you adjust the viewing angle.

3.1 OSD (On-Screen Display) menu

3.1.1 How to reconfigure

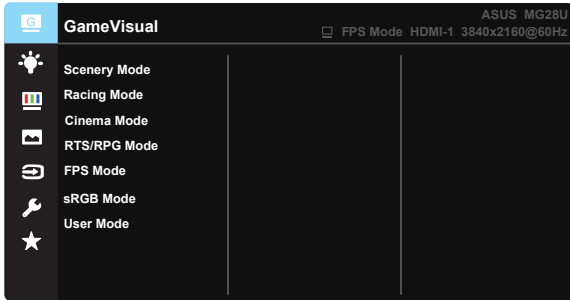

1. Press the MENU button to activate the OSD menu.
2. Press the ▼ and ▲ buttons to toggle between options in the Menu. As you move from one icon to another, the option name is highlighted.
3. To select the highlighted item on the menu press the Center key.
4. Press the ▼ and ▲ buttons to select the desired parameter.
5. Press the Center key to enter the slide bar and then use the ▼ or ▲ buttons, according to the indicators on the menu, to make your changes.
6. Press the ◀ / ▶ to move left / right menu.

3.1.2 OSD Function Introduction

1. GameVisual

This function contains seven sub-functions that you can select for your preference. Each mode has the Reset selection, allowing you to maintain your setting or return to the preset mode.

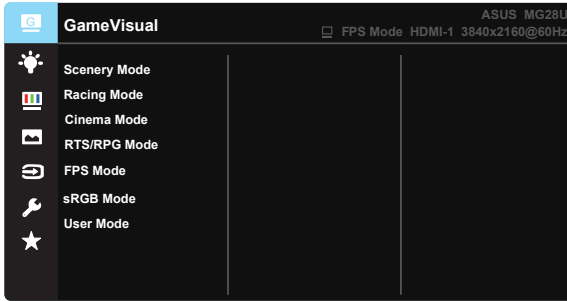

- **Scenery Mode:** This is the best choice for scenery photo displaying with GameVisual™ Video Intelligence Technology.
- **Racing Mode:** This is the best choice for racing game playing with GameVisual™ Video Intelligence Technology.
- **Cinema Mode:** This is the best choice for movie watching with GameVisual™ Video Intelligence Technology.
- **RTS/RPG Mode:** This is the best choice for Real-Time Strategy(RTS)/ Role-Playing Game(RPG) playing with GameVisual™ Video Intelligence Technology.
- **FPS Mode:** This is the best choice for First Person Shooter game playing with GameVisual™ Video Intelligence Technology.
- **sRGB Mode:** This is the best choice for viewing photos and graphics from PCs.
- **User Mode:** More items are adjustable in the Color menu.



-
- In the Racing Mode, the Saturation, SkinTone, Sharpness, and ASCR functions are not user-configurable.
 - In the sRGB, the Saturation, Color Temp., SkinTone, Sharpness, Brightness, Contrast and ASCR functions are not user-configurable.
-

2. Blue Light Filter

Adjust the energy level of blue light emitted from LED backlight

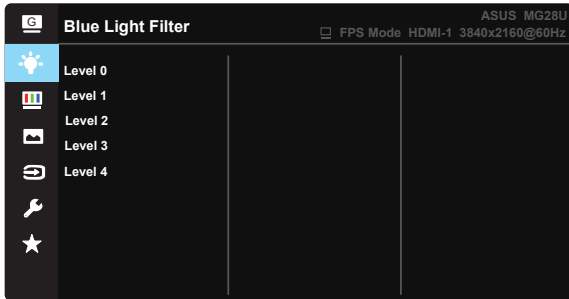

- **Level 0:** No change.
- **Level 1~4:** The higher the level, the more blue light will be reduced.



-
- When Blue Light Filter is activated, the default settings of Racing Mode will be automatically imported.
 - Between Level 1 to Level 3, the Brightness function is user-configurable.
 - Level 4 is optimized setting. It is compliance with TUV Low Blue Light Certification. The Brightness function is not user-configurable.
-

3. Color

Select the image color you like from this function.

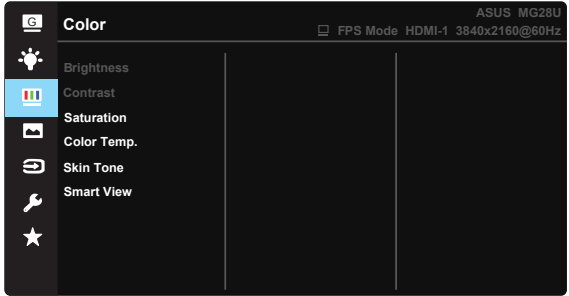

- **Brightness:** The adjusting range is from 0 to 100.
- **Contrast:** The adjusting range is from 0 to 100.
- **Saturation:** The adjusting range is from 0 to 100.
- **Color Temp.:** Contains three preset color modes (**Cool**, **Normal**, **Warm**) and **User Mode**.
- **Skin Tone:** Contains three color modes including **Reddish**, **Natural**, and **Yellowish**.
- **Smart View:** The versatile viewing positions with Smart View Technology.



-
- In the User Mode, colors of R (Red), G (Green), and B (Blue) are user-configurable; the adjusting range is from 0 ~ 100.
-

4. Image

You can adjust the image Sharpness, Trace Free, Aspect Control, VividPixel, ASCR and Adaptive-Sync, from this main function.

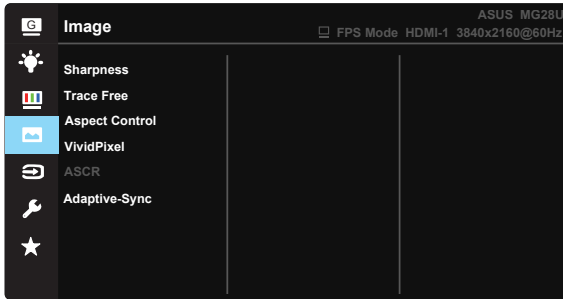

- **Sharpness:** Adjusts the picture sharpness. The adjusting range is from 0 to 100.
- **Trace Free:** Speeds up the response time by Over Drive technology. The adjusting range is from lower 0 to faster 100.
- **Aspect Control:** Adjusts the aspect ratio to “Full”, “4:3”, “1:1”, “Overscan”.
- **VividPixel:** ASUS Exclusive Technology that brings lifelike visuals for crystal-clear and detail-oriented enjoyment. The adjusting range is from 0 to 100.
- **ASCR:** Select **ON** or **OFF** to enable or disable dynamic contrast ratio function.
- **Adaptive-Sync:** It can allow a Adaptive-Sync supported* graphics source to dynamically adjust display refresh rate based on typical content frame rates for power efficient, virtually stutter free and low-latency display update.



-
- 4:3 is only available when input source is in 4:3 format. OverScan is only available for the HDMI input source.
 - Adaptive-Sync only support on full-screen
-

5. Input Select

Select the input source from **HDMI-1 (4K@60Hz)**, **HDMI-2**, **HDMI3** or **DisplayPort** input signal.



6. System Setup

Adjusts the system configuration.

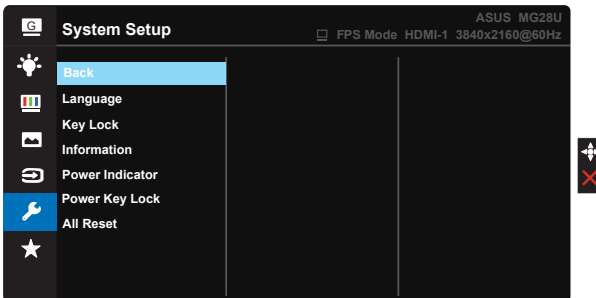
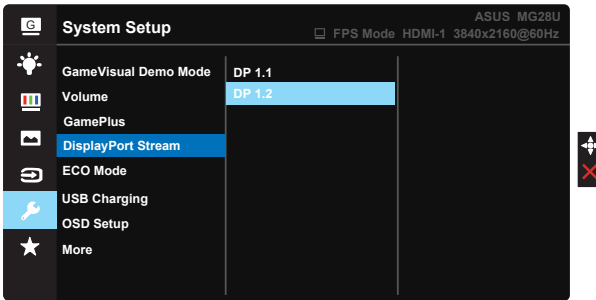

- **GameVisual Demo Mode:** Activate the demo mode for the GameVisual function.
- **Volume:** Adjusts the output volume level.

- **GamePlus:** The GamePlus Function provides a toolkit and creates a better gaming environment for users when playing different types of games. Particularly, Crosshair function is specially designed for new gamers or beginners interested in First Person Shooter (FPS) games.

To active GamePlus:

- Select **ON** to enter the GamePlus main menu.
- Press **▲** and **▼** to select between Crosshair, Timer, FPS Counter function and Display Alignment function.
- Press Center key to confirm the function you choose. Press **◀** to go back. Press X to go off, and exit.

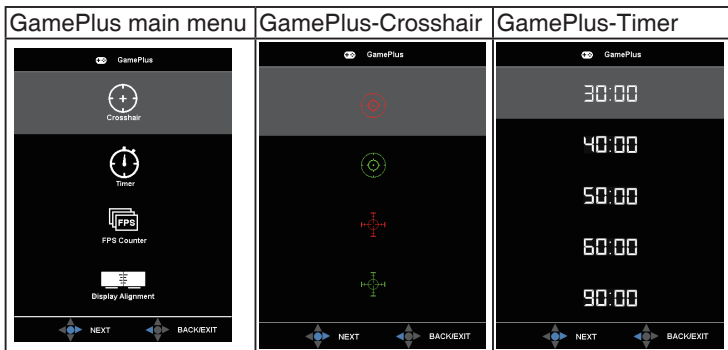

- **DisplayPort Stream:** Compatibility with graphic card. Select DP 1.1 or DP 1.2 by graphic card DP version. (3840x2160-60Hz is available at DP 1.2 only. The best resolution is 3840x2160-30Hz at DP 1.1). Follow the instructions below to change 4K2K, 30Hz to 4K2K, 60Hz on your PC: In Windows, right click the desktop and enter the Screen Resolution. Go to Advanced Settings, and set the refresh rate to 60Hz from 30Hz.
- **ECO Mode:** Activate the ecology mode for power saving.
- **USB Charging:** Turn On/Off USB charging function during the standby mode.
- **OSD Setup:** Adjusts the **OSD Timeout**, **DDC/CI**, and **Transparency** of the OSD screen.
- **More:** Return the next page of System Setting.
- **Back:** Return the previous page of System Setting.
- **Language:** Select OSD language. The selections are: **English, French, German, Spanish, Italian, Dutch, Russian, Poland, Czech, Croatia, Hungary, Romania, Portugal, Turkey, Simplified Chinese, Traditional Chinese, Japanese, Korean, Persian, Thai, Indonesian.**
- **Key Lock:** Disable all key functions. Pressing the down key for more than five seconds to disable key lock function.

- **Information:** Displays the monitor information.
- **Power Indicator:** Turn the power LED indicator on/off.
- **Power Key Lock:** To disable / enable power key.
- **All Reset:** Selects “Yes” to revert all settings to the factory default mode.

7. MyFavorite

Load/Save all settings on the monitor.

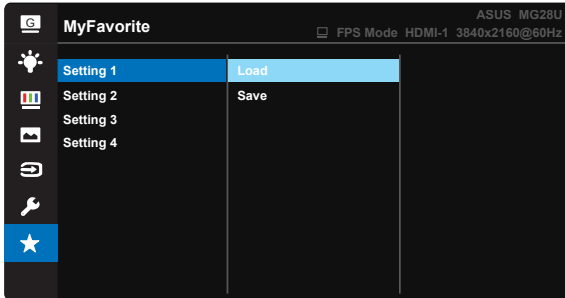

3.2 Specifications

| Model | MG28UQ |
|-----------------------------------|---|
| Panel Size | 28" (71.12 cm) |
| Max. Resolution | 3840 x 2160 |
| Brightness (Typ.) | 300 cd/m ² |
| Intrinsic Contrast Ratio (Typ.) | ≥ 1000:1 |
| Viewing Angle (CR>10) | 170°(V) /160°(H) |
| Display Colors | 1073.7 M (8 bit + FRC) |
| Response Time | 1ms (GTG) |
| Satellite Speaker | 2W x 2 stereo |
| Earphone Output | Yes |
| HDMI input | Yes (HDMI 1.4 x 2, HDMI 2.0 x 1) |
| DisplayPort input | Yes |
| USB 3.0 Hub | Yes (Upstream x 1, Downstream x 2) Note: USB hub definition refer to next page |
| Adaptive-Sync | Yes |
| Power ON Consumption | < 62.9W* |
| Chassis Colors | Black |
| Power saving mode | < 0.5W |
| Power off mode | < 0.5W |
| Tilt | -5° ~ +20° |
| Swivel(angle) | +60°~-60° |
| Pivot(angle/direction) | 90°(clockwise) |
| Height Adjustment (mm) | Yes(0~150mm) |
| VESA Wall Mounting | Yes (100mm x 100mm) |
| Phys. Dimension (WxHxD) | 660.26 x (416~566) x 233.40 mm |
| Phys. Dimension w/o Stand (WxHxD) | 660.26 x 380.67 x 67.40 mm |
| Box Dimension (WxHxD) | 777 x 467 x 224 mm |
| Net Weight (Esti.) | 8 kg |
| Gross Weight (Esti.) | 11 kg |
| Voltage Rating | AC 100~240V(Built-in) |

Note: *Based on Energy Star 6.0 standard

| | | USB B Type Cable Connected PC | USB B Type Cable Non-connected PC |
|--------------|---------------------------------------|----------------------------------|--------------------------------------|
| Power ON | | V | V |
| Power Saving | OSD Charging ON | V | V |
| | OSD Charging OFF (default setting) | X | X |
| Power OFF | OSD Charging ON | V | X |
| | OSD Charging OFF | X | X |

Note: V= Hub On, X= Hub OFF

3.3 Troubleshooting (FAQ)

| Problem | Possible Solution |
|--|---|
| Power LED is not ON | <ul style="list-style-type: none"> Press the  button to check if the monitor is in the ON mode. Check if the power cord is properly connected to the monitor and the power outlet. Check Power Indicator function in main menu OSD. Select "ON" to turn on power LED. |
| The power LED lights amber and there is no screen image | <ul style="list-style-type: none"> Check if the monitor and the computer are in the ON mode. Make sure the signal cable is properly connected the monitor and the computer. Inspect the signal cable and make sure none of the pins are bent. Connect the computer with another available monitor to check if the computer is properly working. |
| Screen image is too light or dark | <ul style="list-style-type: none"> Adjust the Contrast and Brightness settings via OSD. |
| Screen image bounces or a wave pattern is present in the image | <ul style="list-style-type: none"> Make sure the signal cable is properly connected to the monitor and the computer. Move electrical devices that may cause electrical interference. |
| Screen image has color defects (white does not look white) | <ul style="list-style-type: none"> Inspect the signal cable and make sure that none of the pins are bent. Perform Reset via OSD. Adjust the R/G/B color settings or select the Color Temperature via OSD. |
| No sound or sound is low | <ul style="list-style-type: none"> Adjust the volume settings of both your monitor and computer. Make sure the computer sound card driver is properly installed and activated. |

| | |
|---|--|
| <p>Cannot select 3840x2160@60Hz for HDMI</p> | <ul style="list-style-type: none"> • Check the HDMI version of your graphics card. (a) If it is HDMI 1.4, 3840x2160@60Hz output is not available to your card. Change to a HDMI 2.0 card. (b) If it is HDMI 2.0, connect to HDMI-1 (4K@60Hz), i.e. the HDMI port next to DP. <p>Note: The HDMI-1 (4K@60Hz) input port supports up to 3840x2160@60Hz HDMI-2, HDMI-3 input ports support up to 3840x2160@30Hz</p> |
| <p>Cannot select 3840x2160@60Hz for DP</p> | <ul style="list-style-type: none"> • Check the DP version of your graphics card. (a) If it is DP 1.1, 3840x2160@60Hz output is not available to your card. Change to a DP 1.2 card. (b) If it is DP 1.2, set DisplayPort Stream to DP 1.2. |
| <p>PC is on, but DP cannot display anything</p> | <ul style="list-style-type: none"> • Check if your PC is in hibernation. Press any key on the keyboard or click the mouse • Remove and insert the DP signal cable on the PC and display to see if the cable clicks. • Press the power button on the display to see if it is on. • If the card is DP 1.1, press the Source button and select Switch to DP 1.1. |

3.4 Supported Timing List

| Timing List | HDMI1.4 | HDMI2.0 | Display Port 1.2 |
|--------------|---------|---------|------------------|
| 640x350@70 | V | V | V |
| 640x480@60 | V | V | V |
| 640x480@67 | V | V | X |
| 640x480@72 | V | V | X |
| 640x480@75 | V | V | X |
| 720x400@70 | V | V | V |
| 800x600@56 | V | V | X |
| 800x600@60 | V | V | V |
| 800x600@72 | V | V | X |
| 800x600@75 | V | V | X |
| 832x624@75 | V | V | V |
| 848x480@60 | X | X | X |
| 1024x768@60 | V | V | V |
| 1024x768@70 | V | V | X |
| 1024x768@75 | V | V | X |
| 1152x864@75 | V | V | X |
| 1280x720@50 | X | X | X |
| 1280x720@60 | V | V | V |
| 1280x800@60 | V | V | V |
| 1280x960@60 | V | V | V |
| 1280x1024@60 | V | V | V |
| 1280x1024@75 | V | V | X |
| 1440x900@60 | V | V | V |
| 1680x1050@60 | V | V | V |
| 1920x1080@60 | V | V | V |
| 2560x1440@60 | V | V | V |
| 2560x1600@60 | V | V | V |
| 3840x2160@30 | V | V | V |
| 3840x2160@60 | X | V | V |

* Some graphics cards only support up to 1920 x 1200 resolution content transmission via HDMI. Please check with your local distributor or retailer on the hardware limitations of your laptop or desktop.

| Video Timing | | | |
|------------------|---------|---------|------------------|
| Timing List | HDMI1.4 | HDMI2.0 | Display Port 1.2 |
| 720x480P@59.94 | V | V | V |
| 720x480P@60 | V | V | V |
| 720x576P@50 | V | V | X |
| 1280x720P@50 | V | V | X |
| 1280x720P@59.94 | V | V | V |
| 1280x720P@60 | V | V | V |
| 1440x480P@59.94 | V | V | V |
| 1440x480P@60 | V | V | V |
| 1440x576P@50 | V | V | V |
| 1920x1080i@50 | V | V | X |
| 1920x1080i@60 | V | V | V |
| 1920x1080P@23.97 | V | V | X |
| 1920x1080P@24 | V | V | X |
| 1920x1080P@25 | V | V | X |
| 1920x1080P@29.97 | V | V | X |
| 1920x1080P@30 | V | V | X |
| 1920x1080P@50 | V | V | X |
| 1920x1080P@59.94 | V | V | V |
| 1920x1080P@60 | V | V | V |
| 3840x2160P@25 | V | V | X |
| 3840x2160P@29.97 | V | V | X |
| 3840x2160@30 | V | V | X |
| 3840x2160@50 | X | V | X |
| 3840x2160@59.94 | X | V | X |
| 3840x2160@60 | X | V | X |

* The modes not listed in the above tables may not be supported. For optimal resolution, we recommend that you choose a mode listed in the above tables.