



OWNER'S MANUAL

LG Digital Signage

(MONITOR SIGNAGE)

Please read this manual carefully before operating your set and retain it for future reference.

49UH5C
55UH5C
65UH5C

TABLE OF CONTENTS

SAFETY PRECAUTIONS3

- Precautions In Installing the Product.....3
- Precautions to the AC Adapter and Electrical Power5
- Precautions In Moving the Product7
- Precautions In Using the Product8
- Mounting on a Wall.....9

LICENSES..... 10

ASSEMBLY AND PREPARATION 11

- Optional Accessories.....12
- Parts and Buttons.....14
- Assembling the Memory Cover.....15
- Connecting the Stand.....16
- Connecting the Speakers18
- Connecting the IR Sensor20
- Portrait Layout.....21
- Attaching and removing the LG Logo Bracket.....
22
- Installing on a Wall.....24

REMOTE CONTROL 26

MAKING CONNECTIONS..... 28

- Connecting to a PC.....28
- External Device Connection.....28
- Using the Input List30

TROUBLESHOOTING 31

PRODUCT SPECIFICATIONS 34

WARNING - This equipment is compliant with Class A of CISPR 32. In a residential environment this equipment may cause radio interference.

SAFETY PRECAUTIONS

Please read these safety precautions carefully before using the product.

WARNING

If you ignore the warning message, you may be seriously injured or there is a possibility of accident or death.

CAUTION

If you ignore the caution message, you may be slightly injured or the product may be damaged.

WARNING

- Indoor Use Only.

Precautions In Installing the Product

WARNING

- Keep away from heat sources like electrical heaters.
 - Electrical shock, fire, malfunction, or deformation may occur.
- Keep the packing anti-moisture material or vinyl packing out of the reach of children.
 - Anti-moisture material is harmful if swallowed. If swallowed by mistake, force the patient to vomit and visit the nearest hospital. Additionally, vinyl packing can cause suffocation. Keep it out of the reach of children.
- Do not put heavy objects on the product or sit upon it.
 - If the product collapses or is dropped, you may be injured. Children must pay particular attention.
- Do not leave the power or signal cable unattended on the pathway.
 - The passerby can trip or fall, which can cause electrical shock, fire, product breakdown, or injury.
- Install the product in a neat and dry place.
 - Dust or moisture can cause electrical shock, fire or product damage.
- If you can smell smoke or other odors or hear a strange sound unplug the power cord and contact the service center.
 - If you continue to use without taking proper measures, electrical shock or fire can occur.
- If you dropped the product or the case is broken, turn off the product and unplug the power cord.
 - If you continue to use without taking proper measures, electrical shock or fire can occur. Contact the service center.

- Do not drop an object on or apply impact to the product. Do not throw any toys or objects on the product screen.
 - It can cause injury to human, problem to product and damage the display.
- Do not let the product fall or drop when connecting it with an external device.
 - This may cause injury and/or damage to the product.
- When connecting it to a game device, keep a distance of four times the diagonal measurement of the screen from the device.
 - If the product falls because of the short cable, this may cause injury and/or damage to the product.
- Leaving a fixed image on the screen for a long time may cause damage to the screen and cause image burn-in. To use the product for a long period of time, use a screen saver on the PC or utilize the residual image prevention function on the product, and when the product is not used, turn off the power. Burn-in and related problems are not covered by the warranty on this product.
- Do NOT install this product on a wall where there is high risk of exposure to oil fumes or mist.
 - This may damage product and cause it to fall.



CAUTION

- Make sure the product ventilation holes are not blocked. Install the product in a suitably wide place (more than 100 mm from the wall).
 - If you install the product too close to the wall, it may be deformed or fire can break out due to internal heat.
- Do not block the ventilation hole of the product by a tablecloth or curtain.
 - The product can be deformed or fire can break out due to overheating inside the product.
- Install the product on a flat and stable place that has no risk of dropping the product.
 - If the product is dropped, you may be injured or the product may be broken.
- Install the product where no EMI occurs.
- Keep the product away from direct sunlight.
 - The product can be damaged.
- If you install the product in a place that does not meet the recommended conditions, this may cause serious damage to the product's picture quality, life cycle, and appearance. Please check with LG or a qualified installer before installing. This caution applies to a place where there is an abundance of fine dust or oil mist, chemical substances are used, the temperature is very high or low, the humidity is very high, or the product is likely to remain turned on for a long period of time (airport and train station), failure to do so will invalidate the warranty.
- Do not install the product in an area with poor ventilation (e.g. on a bookshelf, in a closet) or outside and avoid placing on cushions or carpets.
- In addition, do not install it where there are heating objects such as lighting equipment.

Precautions to the AC Adapter and Electrical Power

WARNING

- If water or any foreign substance goes inside the product (TV, monitor, power cord, or AC adapter), disconnect the power cord immediately and contact the service center.
 - Otherwise, this may cause a fire or electric shock due to damage to the product.
- Do not touch the power plug or AC adapter with wet hands. If the pins of the plug are wet or dusty, wipe and dry them before use.
 - Otherwise, this may cause a fire or electric shock.
- Make sure to completely insert the power cord into the AC adapter.
 - If loosely connected, the poor connection may cause a fire or electric shock.
- Be sure to use power cords and AC adapters provided or approved by LG Electronics, Inc.
 - The use of non-approved products may cause a fire or electric shock.
- When unplugging the power cord, always pull it by the plug. Do not bend the power cord with excessive force.
 - The power line can be damaged, which may cause electric shock or fire.
- Be careful not to step or place heavy objects (electronic appliances, clothing, etc.) on the power cord or AC adapter. Be careful not to damage the power cord or AC adapter with sharp objects.
 - Damaged power cords may cause a fire or electric shock.
- Never disassemble, repair or modify the power cord or AC adapter.
 - This may cause a fire or electric shock.
- Make sure to connect the power cable to the grounded current.
 - You may be electrocuted or injured.
- Use the rated voltage only.
 - The product can be damaged, or you may be electrocuted.
- In the presence of thunder and lightning, never touch the power cord and signal cable because it can be very dangerous.
 - It can cause electric shock.
- Do not connect several extension cords, electrical appliances, or electrical heaters to a single outlet. Use a power strip with a grounding terminal designed for exclusive use with the computer.
 - A fire can break out due to overheating.
- Do not touch the power plug with wet hands. Additionally, if the cord pin is wet or covered with dust, dry the power plug completely or wipe dust off.
 - You may be electrocuted due to excess moisture.

- If you don't intend to use the product for a long time, unplug the power cable from the product.
 - Covering dust can cause a fire, or insulation deterioration can cause electric leakage, electric shock or fire.
- Fix the power cable completely.
 - If the power cable is not fixed completely, a fire can break out.
- Do not insert a conductor (like a metal chopstick) into one end of the power cable while the other end is connected to the input terminal on the wall. Additionally, do not touch the power cable right after plugging into the wall input terminal.
 - You may be electrocuted.
- The appliance coupler is used as the disconnect device.
- Please make sure the device is installed near the wall outlet to which it is connected and that the outlet is easily accessible.
- As long as this unit is connected to the AC wall outlet, it is not disconnected from the AC power source even if the unit is turned off.

**CAUTION**

- Be sure to keep the outlet, AC adapter, and pins of the power plug clean from dust and etc.
 - This may cause a fire.
- Do not unplug the power cord while the product is in use.
 - Electrical shock can damage the product.
- Use only the power cord supplied with the unit. If you use another power cord, make sure that it is certified by the applicable national standards when not provided by the supplier. If the power cable is faulty in any way, please contact the manufacturer or the nearest authorized repair service provider for a replacement.

Precautions In Moving the Product

WARNING

- Make sure to turn off the product.
 - You may be electrocuted or the product can be damaged.
- Make sure to remove all cables before moving the product.
 - You may be electrocuted or the product can be damaged.
- Make sure the panel faces forward and hold it with both hands to move. If you drop the product, the damaged product can cause electric shock or fire. Contact an authorized the service center for repair.
- Make sure the product is turned off, unplugged, and all cables have been removed. It may take 2 or more people to carry larger apparatus. Do not press against or put stress on the front panel of the apparatus.

CAUTION

- Do not shock the product when moving it.
 - You may be electrocuted or the product can be damaged.
- Do not dispose the product-packing box. Use it when you move.

Precautions In Using the Product

WARNING

- Do not disassemble, repair or modify the product at your own discretion.
 - Fire or electric shock accident can occur.
 - Contact the service center for check, calibration or repair.
- When the display is to be left unattended for an extended period of time, unplug it from the wall outlet.
- Keep the product away from water.
 - Fire or electric shock accident can occur.
- Do not shock or scratch the front and sides of the screen with metallic objects.
 - Otherwise, it may cause damage to the screen.
- Avoid high temperatures and humidity.

CAUTION

- Do not put or store inflammable substances near the product.
 - There is a danger of explosion or fire due to careless handling of the inflammable substances.
- When cleaning the product, unplug the power cord and scrub gently with a soft cloth to prevent scratching. Do not clean with a wet cloth or spray water or other liquids directly onto the product. An electric shock may occur. (Do not use chemicals such as benzene, paint thinners, or alcohol.)
- Take a rest from time to time to protect your vision.
- Keep the product clean at all times.
- Take a comfortable and natural position when working with a product to relax the muscles.
- Take a regular break when working with a product for a long time.
- Do not press strongly upon the panel with a hand or sharp object such as nail, pencil, or pen, or make a scratch on it.
- Keep the proper distance from the product.
 - Your vision may be impaired if you look at the product too closely.
- Set the appropriate resolution and clock by referring to the User's Guide.
 - Your vision can be impaired.
- Use authorized detergent only when cleaning the product. (Do not use benzene, thinner, or alcohol.)
 - Product can be deformed.
- Do not expose to dripping or splashing and do not place objects filled with liquids, such as vases, cups, etc. on or over the apparatus (e.g. on shelves above the unit).
- Batteries should not be exposed to excessive heat. For example, keep away from direct sunlight, open fireplace, and electric heaters.
- Do NOT place non-rechargeable batteries in charging device.
- Using headsets (earphones) for a long time or listening loudly can cause damage to your hearing.

- Spray water onto a soft cloth 2 to 4 times, and use it to clean the front frame; wipe in one direction only. Too much moisture may cause staining.

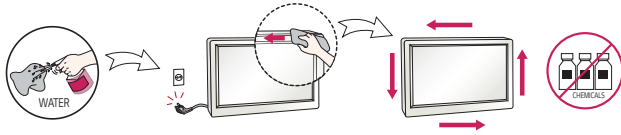

- Do not use products using high voltage around the Monitor. (e.g., a bug zapper)
 - Monitor may have malfunction as its electrical shock.

Mounting on a Wall

- Do NOT install this product by yourself as you may injure yourself or cause damage to product. Please contact service personnel authorised by manufacturer.

LICENSES

Supported licenses may differ by model. For more information of the licenses, visit www.lg.com.



The terms HDMI and HDMI High-Definition Multimedia Interface, and the HDMI Logo are trademarks or registered trademarks of HDMI Licensing LLC in the United States and other countries.



Manufactured under license from Dolby Laboratories. Dolby and the double-D symbol are trademarks of Dolby Laboratories.



For DTS patents, see <http://patents.dts.com>. Manufactured under license from DTS Licensing Limited. DTS, DTS-HD, the Symbol, & DTS or DTS-HD and the Symbol together are registered trademarks of DTS, Inc. © DTS, Inc. All Rights Reserved.

ASSEMBLY AND PREPARATION

CAUTION

- Always use genuine components to ensure safety and product performance.
- The product warranty will not cover damage or injury caused by the use of counterfeit components.

NOTE

- The accessories provided with your product may vary depending on the model or region.
- Product specifications or contents in this manual may be changed without prior notice due to upgrade of product functions.
- SuperSign Software & Manual
 - Downloading from the LG Electronics website.
 - Visit the LG Electronics website (<http://partner.lge.com>) and download the latest software for your model.
- The warranty will not cover any damage caused by using the product in an excessively dusty environment.

Optional Accessories

Without prior notice, optional accessories are subject to change to improve the performance of the product, and new accessories may be added. The illustrations in this manual may differ from the actual product and accessories.

Stand kit

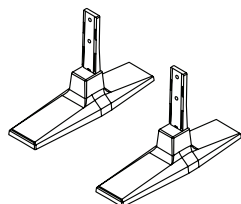

Stand

| | |
|---------|-----------|
| ST-201T | 49/55UH5C |
|---------|-----------|

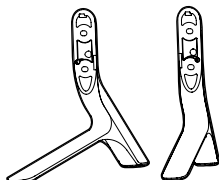

Stand

| | |
|---------|--------|
| ST-651T | 65UH5C |
|---------|--------|

49/55UH5C

65UH5C



Screws

Diameter 4.0 mm x Pitch 0.7 mm

| Model | Length (including spring washer) | Quantity |
|--------|--|----------|
| 49UH5C | 12 mm | 4 EA |
| 55UH5C | 12 mm | 4 EA |
| 65UH5C | 14 mm | 4 EA |

Speaker kit

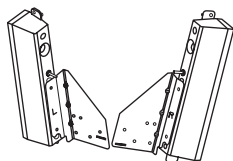

Speakers
SP-5200



Cable holder/
Cable Tie



Screws

Diameter 4.0 mm x Pitch 0.7
mm x Length 8 mm
(including spring washer)

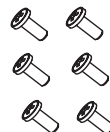

Screws

Diameter 4.0 mm x Pitch 1.6
mm x Length 10 mm

Media Player kit

(It may not be supported depending on the model.)

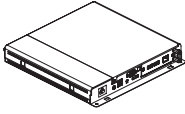

Media Player
MP500/ MP700



Screws

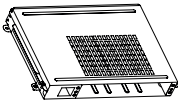

CD (Owner's Manual)/ Cards

OPS kit

KT-OPSA

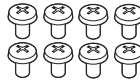

Screws

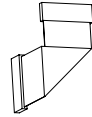

Connecting Cable



Card (Easy Setup Guide)

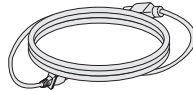

Power Cord

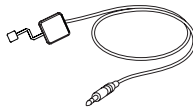
Pixel sensor kit

KT-SP0

! NOTE

- Cable holder/cable tie may not be available in some areas or for some models.
- Optional accessories are available for some models. If necessary, please purchase them separately.
- Pixel sensor is sold separately. You can obtain additional accessories from your local retail store.
- Before you attach the OPS kit or Media Player, connect the cable to the port.

Parts and Buttons

The image may be different according to the model.

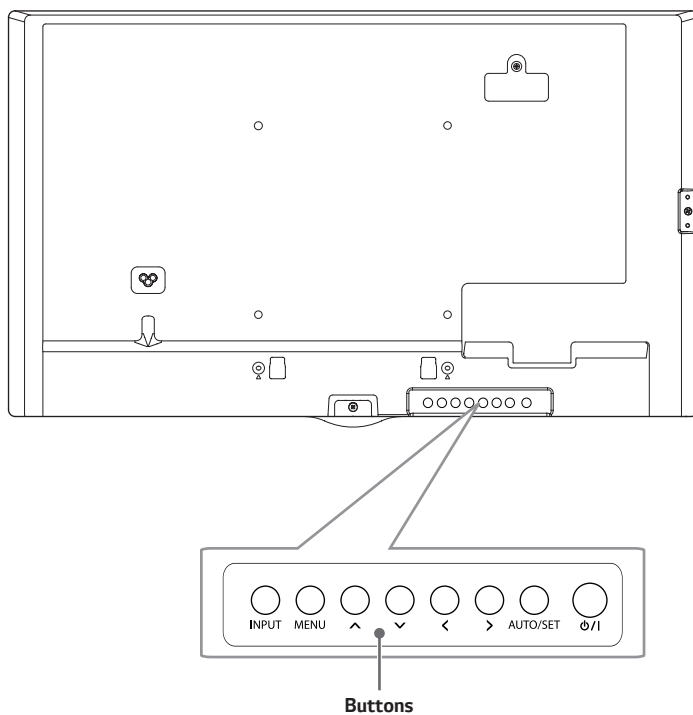

- **INPUT:** Changes the input source.
- **MENU:** Accesses the main menus, or saves your input and exits the menus.
- **▲▼:** Adjust the up and down.
- **◀▶:** Moves left and right.
- **AUTO/SET:** Displays the current signal and mode.
- **⏻/I:** Turns the power on or off.

Assembling the Memory Cover

Assemble the cover with a screw as illustrated to prevent the USB memory from theft.

1

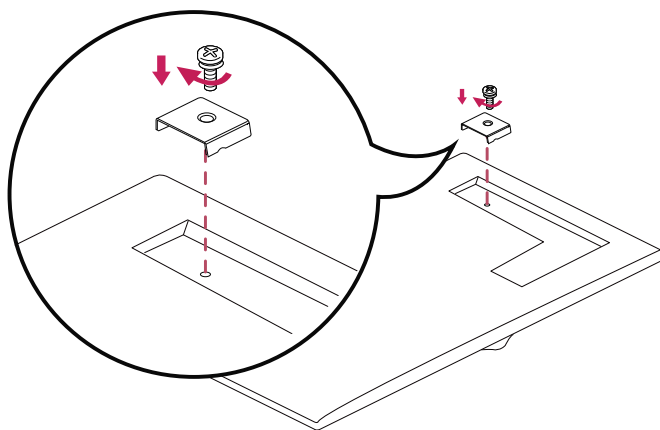

2

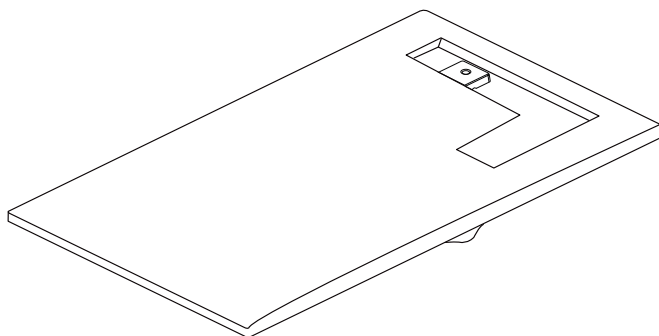

Connecting the Stand

- For certain models only.
- The image may be different according to the model.

49/55UH5C

1

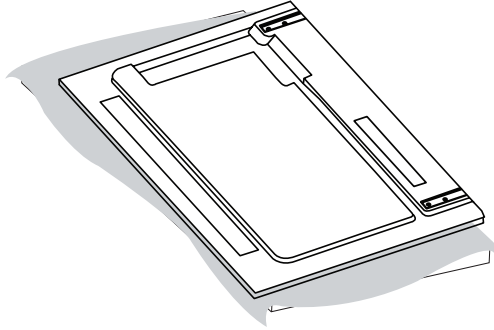

2

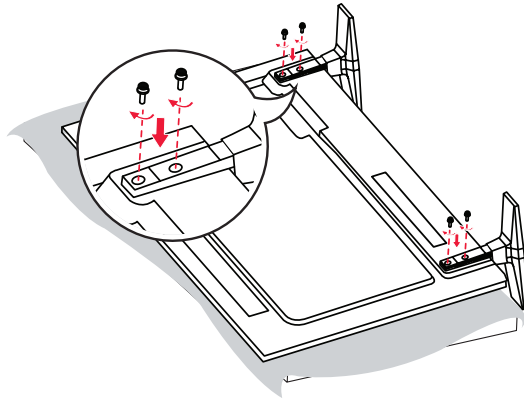

65UH5C

1

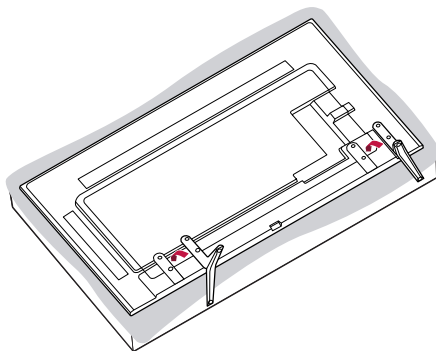

2

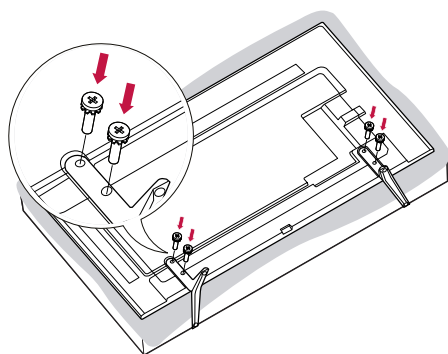

Connecting the Speakers

- For certain models only.
- The image may be different according to the model.

- 1 Connect an input signal cable before installing the speakers.

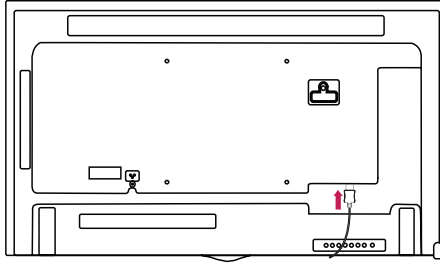

- 2 Mount the speakers by using screws as shown below. Make sure the power cable is disconnected before making a connection.

Basic installation

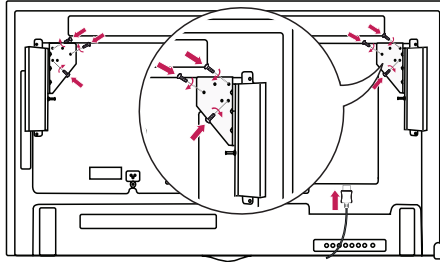

Installation with OPS connected

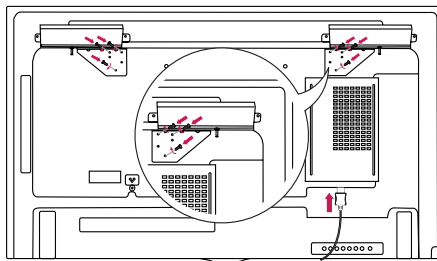

- 3 Then connect the speaker cable. After installing your speakers, use holders and cable ties to organize the speaker cables.

Basic installation

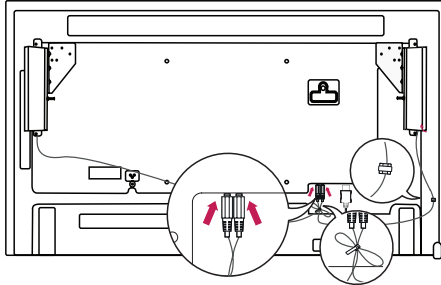

Installation with OPS connected

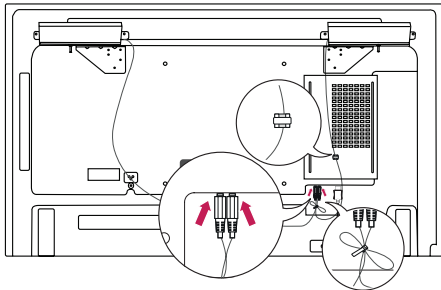

! NOTE

- Please turn off the power before removing the cable. Connecting or removing the speaker cable while turned on may result in no sound.

Connecting the IR Sensor

When you connect the cable to the product, the feature for receiving remote control signals is activated. Rotate the IR sensor according to the screen orientation (Landscape/Portrait).

- The image may be different according to the model.

Basic installation



[Front]

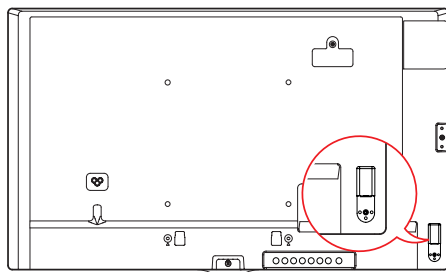

[Rear]

Landscape scene

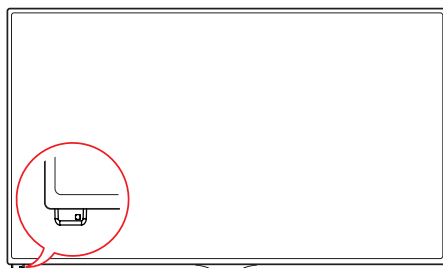

[Front]

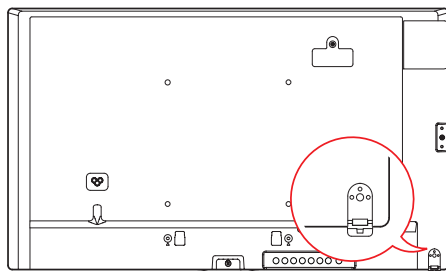

[Rear]

Portrait scene

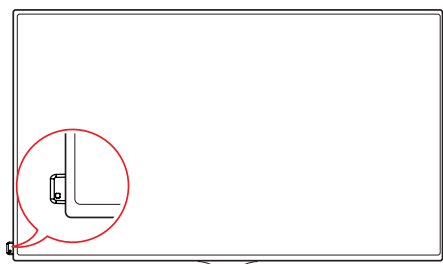

[Front]

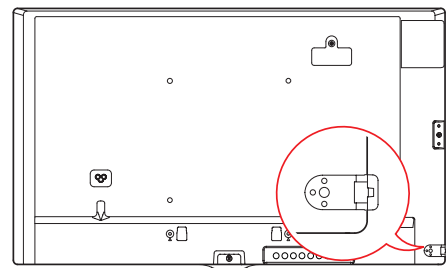

[Rear]

Portrait Layout

When installing in a portrait layout, rotate the monitor counterclockwise 90 degrees (when facing the screen).

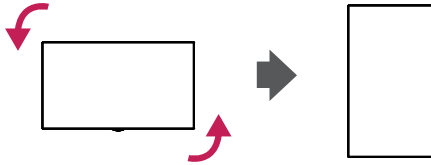

Using Kensington Lock

(This is not available for all models.)

The Kensington security system connector is located at the back of the monitor. For more information on installation and use of this system, refer to the manual provided with the Kensington security system or visit <http://www.kensington.com>.

Connect the Kensington security system cable between the monitor and a table.

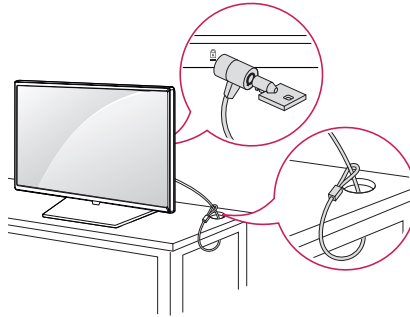

! NOTE

- The Kensington security system is optional. You can obtain additional accessories from most electronics retail stores.
- The illustration shows a general example of installation and may look different from the actual product.

Attaching and removing the LG Logo Bracket

- For certain models only.
- The image may be different according to the model.

Removing the LG Logo Bracket

- 1 Lay a clean cloth on the floor, and then put the monitor on it with the screen face down. Using a screwdriver, remove the screw that secures the LG Logo Bracket to the bottom rear of the monitor.

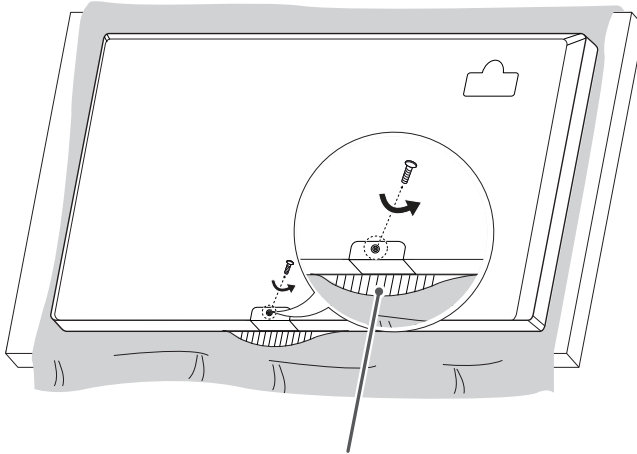

LG Logo Bracket

- 2 After removing the screw, remove the LG Logo Bracket. When re-attaching the LG Logo Bracket, repeat the process in reverse order.

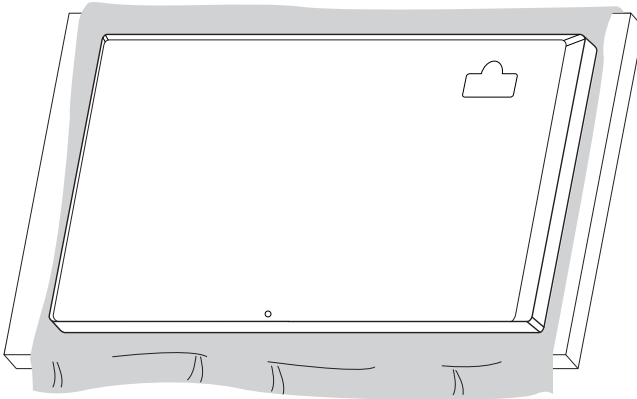

Attaching the LG Logo Bracket on the right side

- 1 Lay a clean cloth on the floor, and then put the monitor on it with the screen face down. Using a screwdriver, remove the screw that secures the LG Logo Bracket to the bottom rear of the monitor.

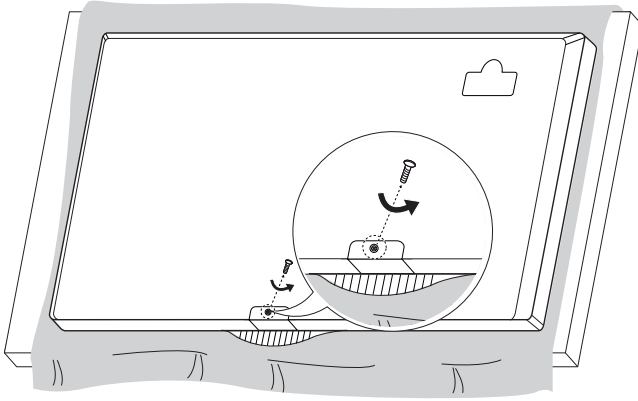

- 2 After removing the screw, remove the LG Logo Bracket. Attach the LG Logo Bracket with a screw, aligning it with the hole on the right side.

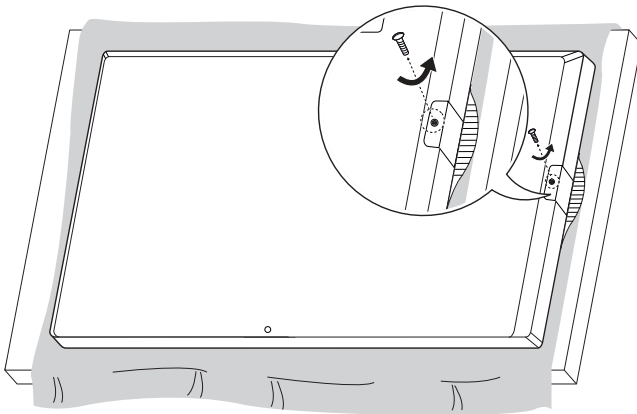

Installing on a Wall

For proper ventilation, allow a clearance of 100 mm on each side and from the wall. Detailed installation instructions are available from your dealer, see the optional Tilt Wall Mounting Bracket Installation and Setup Guide.

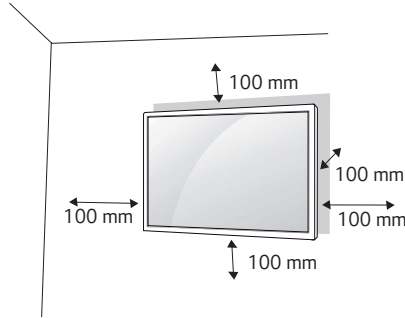

To install your monitor on a wall, attach a wall mounting bracket (optional part) to the back of the monitor. Make sure that the wall mounting bracket is securely fixed to the monitor and to the wall.

- 1 Use only screws and wall mounting brackets that conform to VESA standards.
- 2 Screws which are longer than standard length may damage the inside of the monitor.
- 3 A non-VESA standard screw may damage the product and cause the monitor to fall. LG Electronics is not liable for any accidents related to the use of non-standard screws.
- 4 Please use VESA standard as below.
 - 785 mm and above
 - * Fixing screws: Diameter 6.0 mm x Pitch 1.0 mm x Length 12 mm

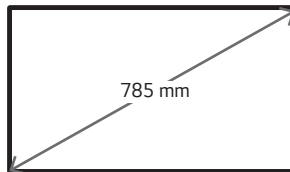

 **CAUTION**

- Disconnect the power cord before moving or installing the monitor to avoid risk of electric shock.
- If you install the monitor on a ceiling or slanted wall, it may fall and result in injury. Use an authorized LG wall mount and contact your local dealer or qualified personnel to assist with the installation.
- Do not over tighten the screws as this may damage the monitor and void your warranty.
- Use only screws and wall mounting brackets that meet the VESA standard. Any damage or injuries caused by misuse or use of improper accessories are not covered by the warranty.
- To prevent injury, this apparatus must be securely attached to the wall in accordance with the installation instructions. (This pertains only to Australia and New Zealand.)

 **NOTE**

- The wall mount kit includes the installation guide and all necessary parts.
- The wall mounting bracket is optional. You can obtain additional accessories from your local dealer.
- The length of screws required may differ depending on the wall mount. Be sure to use the correct length.
- For more information, please refer to the guide provided with the wall mount.

REMOTE CONTROL

The descriptions in this manual are based on the buttons on the remote control. Please read this manual carefully to use the monitor correctly. To install batteries, open the battery cover, place batteries (1.5 V AAA) matching \oplus and \ominus terminals to the labels inside the compartment, and close the battery cover. To remove the batteries, perform the installation actions in reverse. The illustrations may differ from the actual accessories.

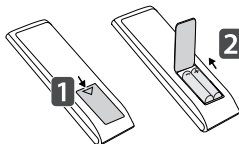

CAUTION

- Do not mix old and new batteries, as this may damage the remote control.
- Be sure to point the remote control toward the remote control sensor on the monitor.
- Some features of the remote control may not be supported in certain models.

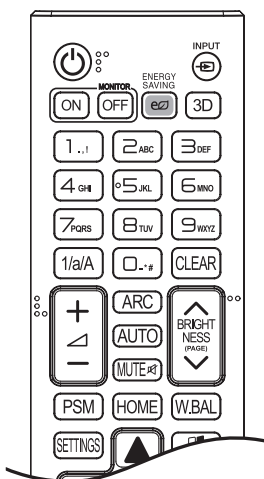

or

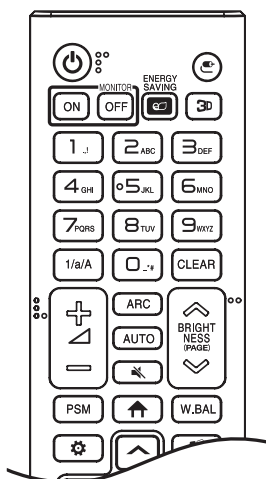

POWER Turns the monitor on or off.

MONITOR ON Turns the monitor on.

MONITOR OFF Turns the monitor off.

ENERGY SAVING Adjusts the brightness of the picture to reduce energy consumption.

INPUT Selects the input mode.

3D / 3D Used for viewing 3D videos.

1/a/A Toggles between numerical and alphabetical.

Number and Alphabet buttons

Enters numerical or alphabetical characters depending upon the setting.

CLEAR Deletes the entered numerical or alphabetical character.

Volume Up/Down Button Adjusts the volume.

ARC Selects the Aspect Ratio mode.

AUTO Automatically adjusts picture position and minimizes image instability (available for RGB input only).

MUTE Mutes all sounds.

BRIGHTNESS Adjusts the brightness of the display. PAGE function is not supported in this model.

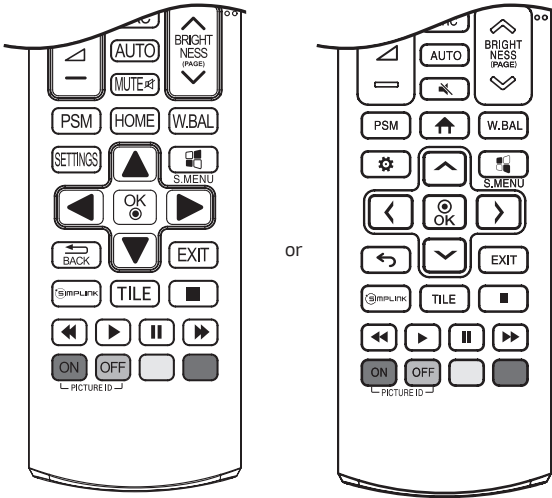

PSM Selects the Picture Mode.

HOME / ↑ Activates the Launcher.

W.BAL Enters the White Balance menu.

SETTINGS / ⚙️ Accesses the main menu or saves your input and exit menus.

Ⓜ️ S.MENU SuperSign menu key.

Navigation Buttons Scrolls through menus or options.

Ⓞ / Ⓞ Selects menus or options and confirms your input.

← / ↶ Allows you to move back one step in the user interaction function.

EXIT Quit all OSD tasks and applications.

Ⓜ️ SIMPLINK Allows you to control various multimedia devices to enjoy multimedia simply by using the remote control through the Simplink menu.

TILE Selects the TILE Mode.

PICTURE ID ON/OFF When the Picture ID number matches the Set ID number, you can control whichever monitor you want in multi-display format.

USB Menu Control Buttons Controls media playback.

MAKING CONNECTIONS

You can connect various external devices to your monitor. Change the input mode and select the external device you want to connect. For more information about external device connections, see the user manual provided with each device.

Connecting to a PC

Some of the cables are not provided.

This monitor supports the Plug and Play* feature.

* Plug and Play: a feature that enables a PC to recognize devices attached by the user without device configuration or user intervention when powering up.

External Device Connection

Connect a HD receiver, DVD, or VCR player to the monitor and select an appropriate input mode.

Some of the cables are not provided. For the best picture and sound quality, connecting external devices to your monitor using HDMI cables is recommended.

! NOTE

- For the best image quality, using the monitor with HDMI connection is recommended.
- To comply with the specifications of the product, use a shielded interface cable with ferrite core, such as a D-sub 15-pin cable and DVI-D/HDMI cable.
- If you turn the monitor on when the set is cold, the screen may flicker. This is normal.
- Sometimes red, green, or blue spots may appear on the screen. This is normal.
- Use a High Speed HDMI®/TM cable.
- Use a certified cable with the HDMI logo attached. If you do not use a certified HDMI cable, the screen may not display or a connection error may occur.
- Recommended HDMI Cable Types
 - High-Speed HDMI®/TM Cable
 - High-Speed HDMI®/TM Cable with Ethernet
- If you cannot hear any sound in HDMI mode please check your PC settings. Some PCs require you to manually change the default audio output to HDMI.
- If you want to use HDMI-PC mode, you must set your PC/DTV to PC mode.
- You may experience compatibility issues if you use HDMI-PC mode.
- Make sure the power cable is disconnected.
- If you connect a gaming device to the monitor, use the cable provided with the gaming device.
- It is recommended to use the speakers that are provided as optional accessories.
- High Speed HDMI®/TM cables transmit a HD signal up to 1080p and higher.

⚠ CAUTION

- Connect the signal input cable and tighten it by turning the screws clockwise.
- Do not press the screen with your finger for a prolonged period as this may result in temporary distortion on the screen.
- Avoid displaying static images on the screen for a long period of time to prevent image burn. Use a screensaver if possible.
- A wireless communication device near your monitor can affect the image.

Using the Input List

HOME /  → 

- HDMI1 → HDMI2 → OPS/DVI-D → DISPLAYPORT

TROUBLESHOOTING

No image is displayed.

| Problem | Action |
|---|---|
| Is the product power cord connected? | <ul style="list-style-type: none"> • Check if the power cord is correctly plugged into the power outlet. |
| Does the "Invalid Format" message appear? | <ul style="list-style-type: none"> • The signal from the PC (Graphics card) is out of the vertical or horizontal frequency range of the product. Adjust the frequency range by referring to the Specifications in this manual. |
| Does the "No Signal" message appear? | <ul style="list-style-type: none"> • The signal cable between PC and product is not connected. Check the signal cable. • Press the INPUT menu in the remote control to check the input signal. |

The Unknown Product message appears when the product is connected.

| Problem | Action |
|-----------------------------|---|
| Did you install the driver? | <ul style="list-style-type: none"> • Check if the Plug and Play function is supported by referring to the graphics card user manual. |

The screen image looks abnormal.

| Problem | Action |
|-------------------------------------|--|
| Is the screen position wrong? | <ul style="list-style-type: none"> • Check if the graphics card resolution and frequency are supported by the product. If the frequency is out of range, set to the recommended resolution in the [Control Panel] → [Display] → [Setting] menu. (The settings may differ depending on your operating system.) |
| The screen is displayed abnormally. | <ul style="list-style-type: none"> • The proper input signal is not connected to the signal port. Connect the signal cable that matches with the source input signal. |

After-image appears on the product.

| Problem | Action |
|---|---|
| After-image appears when the product is turned off. | <ul style="list-style-type: none"> • If you use a fixed image for a long time, the pixels may be damaged. Use the screen-saver function. • When a dark image is displayed on the screen after an image with high contrast (black and white or gray), this may cause image sticking. This is normal for LCD screen products. |

The audio function does not work.

| Problem | Action |
|--------------------|--|
| No sound? | <ul style="list-style-type: none"> • See if the audio cable is connected properly. • Adjust the volume. • See if the sound is set properly. |
| Sound is too dull. | <ul style="list-style-type: none"> • Select the appropriate equalizer sound. |
| Sound is too low. | <ul style="list-style-type: none"> • Adjust the volume. |

Screen color is abnormal.

| Problem | Action |
|---|---|
| Screen has poor color resolution (16 colors). | <ul style="list-style-type: none"> • Set the number of colors to more than 24 bits (true color). Select [Control Panel] → [Display] → [Settings] → [Color Table] in Windows. (The settings may differ depending on your operating system.) |
| Screen color is unstable or mono-colored. | <ul style="list-style-type: none"> • Check the connection status of the signal cable. Or, re-insert the PC graphics card. |
| Do black spots appear on the screen? | <ul style="list-style-type: none"> • Several pixels (red, green, blue, white, or black color) may appear on the screen, which can be attributable to the unique characteristics of the LCD panel. This is not a malfunction of the LCD. |

The operation does not work normally.

| Problem | Action |
|--------------------------------|---|
| The power suddenly turned off. | <ul style="list-style-type: none"> • Is the Timer set? • Check the power control settings. Power interrupted. |

⚠ CAUTION

- Image sticking does not occur when using constantly changing images but may occur when using a fixed image for an extended period of time. Therefore, it is recommended that you use the instructions below to decrease the likelihood of image sticking occurring when using a fixed image. It is recommended that you change the screen at least once every 12 hours at the very minimum; if done more frequently, the prevention of image sticking is more effective.

Recommended operating conditions

- 1 Change the background and the character colors using the same time interval.



When changing colors, using complementary colors helps to prevent image sticking.

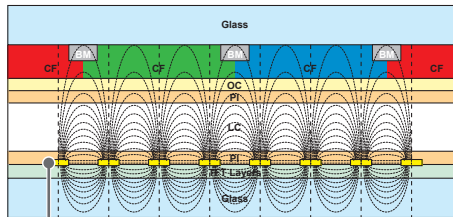

ITO or MoTi Pixel Layer

- 2 Change the image using the same time interval.

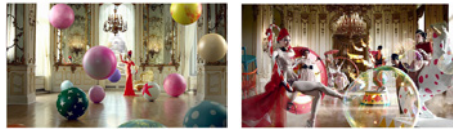

Make sure that the characters or images before changing the image remain in the same location after changing the image.

What is image sticking?

When the LCD panel displays a static image for an extended period of time, it can cause a voltage difference between the electrodes that operate the liquid crystals. When the voltage difference between the electrodes builds up over time, liquid crystals have a tendency to remain aligned in one direction. During this process, a previously displayed image remains visible. This phenomenon is referred to as image sticking.

PRODUCT SPECIFICATIONS

The product specifications below may be changed without prior notice due to upgrade of product functions.
 “~” refers to alternating current (AC), and “—” refers to direct current (DC).

| | | |
|--------------------------|------------------------|--|
| LCD screen | Screen type | Thin Film Transistor (TFT) Liquid Crystal Display (LCD) Screen |
| Video signal | Maximum resolution | DVI-D/OPS: 1920 × 1080 @ 60 Hz HDMI1/HDMI2/Displayport: 3840 × 2160 @ 60 Hz - This may not be supported on some OS or graphics card types. |
| | Recommended resolution | DVI-D/OPS: 1920 × 1080 @ 60 Hz HDMI1/HDMI2/Displayport: 3840 × 2160 @ 60 Hz - This may not be supported on some OS or graphics card types. |
| | Horizontal frequency | DVI-D/OPS: 30 kHz to 83 kHz HDMI1/HDMI2/Displayport: 30 kHz to 135 kHz |
| | Vertical frequency | 30 Hz to 60.31 Hz |
| | Synchronization | Separate Sync, Digital |
| Input/output ports | | SPEAKER OUT, HDMI1, HDMI2, LAN, PIXEL SENSOR, IR & LIGHT SENSOR, DP IN/OUT, DVI-D IN, SD, USB 3.0 IN, AUDIO IN/OUT, RS-232C IN/OUT |
| Embedded battery | | Applied |
| Environmental Conditions | Operating Temperature | 0 °C to 40 °C |
| | Operating Humidity | 10 % to 80 % |
| | Storage Temperature | -20 °C to 60 °C |
| | Storage Humidity | 5 % to 85 % |

* Applicable only for models that support the speakers

| | | |
|-------|-------------------|---------------------|
| Audio | RMS Audio Output | 10 W + 10 W (R + L) |
| | Input Sensitivity | 0.7 Vrms |
| | Speaker Impedance | 6 Ω |

49UH5C

| | | |
|--|------------------------|--|
| LCD screen | Pixel pitch | 0.27963 mm (H) x 0.27963 mm (V) |
| Power | Rated power | AC 100-240 V ~ 50/60 Hz 1.2 A |
| | Power consumption | On Mode: 102 W (Typ.) Sleep Mode (DVI-D, HDMI1, HDMI2): ≤ 0.5 W Sleep Mode (DisplayPort): ≤ 0.5 W Off Mode: ≤ 0.5 W |
| Dimensions (Width x Height x Depth) / Weight | Head | 1103.2 mm x 648 mm x 38.6 mm / 13.3 kg |
| | Head + Stand | 1103.2 mm x 714.1 mm x 298.3 mm / 14.8 kg |
| | Head + Speaker | 1103.2 mm x 648 mm x 86.6 mm / 14 kg |
| | Head + Speaker + Stand | 1103.2 mm x 714.1 mm x 298.3 mm / 15.5 kg |

55UH5C

| | | |
|--|------------------------|--|
| LCD screen | Pixel pitch | 0.315 mm (H) x 0.315 mm (V) |
| Power | Rated power | AC 100-240 V ~ 50/60 Hz 1.4 A |
| | Power consumption | On Mode: 116 W (Typ.) Sleep Mode (DVI-D, HDMI1, HDMI2): ≤ 0.5 W Sleep Mode (DisplayPort): ≤ 0.5 W Off Mode: ≤ 0.5 W |
| Dimensions (Width x Height x Depth) / Weight | Head | 1239.8 mm x 725.2 mm x 38.6 mm / 16.6 kg |
| | Head + Stand | 1239.8 mm x 788.8 mm x 298.3 mm / 18.1 kg |
| | Head + Speaker | 1239.8 mm x 725.2 mm x 86.6 mm / 17.3 kg |
| | Head + Speaker + Stand | 1239.8 mm x 788.8 mm x 298.3 mm / 18.8 kg |

65UH5C

| | | |
|--|------------------------|--|
| LCD screen | Pixel pitch | 0.372 mm (H) x 0.372 mm (V) |
| Power | Rated power | AC 100-240 V ~ 50/60 Hz 1.5 A |
| | Power consumption | On Mode: 134 W (Typ.) Sleep Mode (DVI-D, HDMI1, HDMI2): ≤ 0.5 W Sleep Mode (DisplayPort): ≤ 0.5 W Off Mode: ≤ 0.5 W |
| Dimensions (Width x Height x Depth) / Weight | Head | 1458.6 mm x 848.9 mm x 40.1 mm / 26 kg |
| | Head + Stand | 1458.6 mm x 915.8 mm x 313.9 mm / 27.4 kg |
| | Head + Speaker | 1458.6 mm x 848.9 mm x 87.1 mm / 26.7 kg |
| | Head + Speaker + Stand | 1458.6 mm x 915.8 mm x 313.9 mm / 28.1 kg |

| Wireless module(LGSBW41)Specifications | |
|--|---------------------|
| Wireless LAN (IEEE 802.11a/b/g/n) | |
| Frequency range (MHz) | Output power (Max.) |
| 2400 to 2483.5 | 16 dBm |
| 5150 to 5250 | 16 dBm |
| 5725 to 5850 (Not for EU) | 11.5 dBm |
| Bluetooth | |
| Frequency range (MHz) | Output power (Max.) |
| 2400 to 2483.5 | 10 dBm |
| <ul style="list-style-type: none"> As band channels can vary per country, the user cannot change or adjust the operating frequency. This product is configured for the regional frequency table. For consideration of the user, this device should be installed and operated with a minimum distance of 20 cm between the device and the body. | |
| (Only Nigeria) | |
| <div style="border: 1px solid black; padding: 5px;"> <p><u>Connection and use of this communications equipment is permitted by the Nigerian Communications Commission</u></p> </div> | |

(Only HongKong)

| Wireless module(LGSBW41)Specifications | | | |
|--|---|-----------------------|-----------------|
| Wireless LAN | | Bluetooth | |
| Standard | IEEE 802.11a/b/g/n | Standard | Bluetooth |
| Frequency range (MHz) | 2400 to 2483.5 5150 to 5250 5725 to 5850 | Frequency range (MHz) | 2400 to 2483.5 |
| Output power (Max.) | 802.11a: 13 dBm 802.11b: 15 dBm 802.11g: 14 dBm 802.11n - 2.4 GHz: 16 dBm 802.11n - 5 GHz: 16 dBm | Output power (Max.) | 10 dBm or Lower |
| <ul style="list-style-type: none"> As band channels can vary per country, the user cannot change or adjust the operating frequency. This product is configured for the regional frequency table. For consideration of the user, this device should be installed and operated with a minimum distance of 20 cm between the device and the body. | | | |

HDMI/ DVI-D/ DisplayPort/ OPS (PC) Support mode

| Resolution | Horizontal frequency (kHz) | Vertical frequency (Hz) | Remark |
|-------------|----------------------------|-------------------------|-------------------|
| 800 x 600 | 37.879 | 60.317 | |
| 1024 x 768 | 48.363 | 60 | |
| 1280 x 720 | 44.772 | 59.855 | |
| 1366 x 768 | 47.7 | 60 | |
| 1280 x 1024 | 63.981 | 60.02 | |
| 1680 x 1050 | 65.29 | 59.954 | |
| 1920 x 1080 | 67.5 | 60 | |
| 3840 x 2160 | 67.5 | 30 | HDMI/ DisplayPort |
| 3840 x 2160 | 135 | 60 | HDMI/ DisplayPort |

HDMI/ DisplayPort/ OPS (DTV) Support Mode

| Resolution | Horizontal frequency (kHz) | Vertical frequency (Hz) | Remark |
|------------|----------------------------|-------------------------|-------------------|
| 480/60p | 31.5 | 60 | 0 |
| 576/50p | 31.25 | 50 | 0 |
| 720/50p | 37.5 | 50 | 0 |
| 720/60p | 45 | 60 | 0 |
| 1080/50i | 28.1 | 50 | 0 |
| 1080/60i | 33.75 | 60 | 0 |
| 1080/50p | 56.25 | 50 | 0 |
| 1080/60p | 67.432 | 59.94 | 0 |
| 1080/60p | 67.5 | 60 | 0 |
| 2160/30p | 67.5 | 30 | HDMI/ DisplayPort |
| 2160/50p | 112.5 | 50 | HDMI/ DisplayPort |
| 2160/60p | 135 | 60 | HDMI/ DisplayPort |

Multi-screen (PC) Support mode

| Resolution | Horizontal frequency (kHz) | Vertical frequency (Hz) | Remark |
|-------------|----------------------------|-------------------------|---------------------------------|
| 1280 x 720 | 44.772 | 59.855 | |
| 1920 x 1080 | 67.5 | 60 | |
| 3840 x 2160 | 67.5 | 30 | HDMI1/2, DisplayPort PIP (Main) |

Multi-screen (DTV) Support mode

| Resolution | Horizontal frequency (kHz) | Vertical frequency (Hz) | Remark |
|------------|----------------------------|-------------------------|---------------------------------|
| 720/50P | 37.5 | 50 | |
| 720/60P | 45 | 60 | |
| 1080/50P | 56.25 | 50 | |
| 1080/60P | 67.5 | 60 | |
| 2160/30P | 67.5 | 30 | HDMI1/2, DisplayPort PIP (Main) |

! NOTE

- PC resolutions available for the Input Label option in HDMI / DVI-D / DisplayPort input modes: 1280 x 720/60 Hz, 1920 x 1080/60 Hz; 480p, 720p, and 1080p DTV resolutions.
- Vertical frequency: The product display functions by the screen image changing dozens of times every second like a fluorescent lamp.
The vertical frequency or refresh rate is the number of image displays per second. The unit is Hz.
- Horizontal frequency: The horizontal interval is the time taken to display one horizontal line. When 1 is divided by the horizontal interval, the number of horizontal lines displayed every second can be tabulated as the horizontal frequency. The unit is kHz.



ENERGY STAR® is a set of power-saving guidelines issued by the U.S. Environmental Protection Agency (EPA).

As an ENERGY STAR® Partner LGE U. S. A., Inc. has determined that this product meets the ENERGY STAR® guidelines for energy efficiency.

Refer to ENERGYSTAR.gov for more information on the ENERGY STAR® program.

Make sure to read the Safety Precautions before using the product.

The model and serial numbers of the SET are located on the back and one side of the SET. Record it below should you ever need service.

MODEL _____

SERIAL _____

Temporary noise is normal when powering ON or OFF this device.