

# **User's Manual**

## **Large Format Display**

MultiSync P654Q

MultiSync P754Q

MODEL: P654Q, P754Q

Please find your model name in the label on the rear side of monitor.

# Index

---

Registration Information .....	English-1
Important Information .....	English-2
WARNING .....	English-2
CAUTION .....	English-2
Safety Precautions, Maintenance & Recommended Use .....	English-3
Safety Precautions and Maintenance .....	English-3
Recommended Use .....	English-3
Ergonomics .....	English-3
Cleaning the LCD Panel .....	English-4
Cleaning the Cabinet .....	English-4
Installation .....	English-5
Attaching Mounting Accessories .....	English-7
Parts Name and Functions .....	English-10
Control Panel .....	English-10
Terminal Panel .....	English-11
Wireless Remote Control .....	English-13
Operating Range for the Remote Control .....	English-14
Setup .....	English-15
Connections .....	English-17
Wiring Diagram .....	English-17
Connecting to a Personal Computer .....	English-18
Connecting to a Player or Computer with HDMI .....	English-18
Connecting to a Computer with DisplayPort .....	English-18
Connecting a USB device .....	English-19
Basic Operation .....	English-20
Power ON and OFF Modes .....	English-20
Power Indicator .....	English-21
Using Power Management .....	English-21
Aspect .....	English-21
Media Player .....	English-22
Displayable/playable files .....	English-22
File display screen .....	English-24
Slideshow display .....	English-25
Media Player settings .....	English-25
NETWORK & OTHER SETTINGS .....	English-26
Using SHARED SD card SETTINGS .....	English-27
Using CONTENTS COPY .....	English-28
Using Emergency contents .....	English-28
Information OSD .....	English-28
Picture Mode .....	English-29
OSD (On-Screen-Display) Controls .....	English-32
INPUT .....	English-33
PICTURE .....	English-33
AUDIO .....	English-35
SCHEDULE .....	English-36
MULTI INPUT .....	English-37
OSD .....	English-39
MULTI DISPLAY .....	English-39
DISPLAY PROTECTION .....	English-41
CONTROL .....	English-41
OPTION .....	English-44
SYSTEM .....	English-45
COMPUTE MODULE .....	English-45
Remote Control Functions .....	English-47
Multiple Monitors Connection .....	English-48
Controlling the LCD monitor via RS-232C Remote Control .....	English-49
Controlling the LCD monitor via LAN Control .....	English-51
Connecting to a Network .....	English-51
Network Setting by Using an HTTP Browser .....	English-51
POINT ZOOM .....	English-59
PROOF OF PLAY .....	English-60
INTELLIGENT WIRELESS DATA .....	English-61
MULTIPICTURE matrix .....	English-61
Video out .....	English-68
Features .....	English-69
Troubleshooting .....	English-70
Specifications - P654Q .....	English-72
Specifications - P754Q .....	English-73
Manufacturer's Recycling and Energy Information .....	English-74
[Notice] About the MPEG-4 AVC, MPEG-4 Visual license included in this product .....	English-76

# Registration Information

## Cable Information

- ⚠ CAUTION:** Use the provided specified cables with this product so as not to interfere with radio and television reception.
- For USB please use a shielded signal cable with ferrite core.
  - For HDMI, DisplayPort and D-Sub 9-pin, please use a shielded signal cable.
  - For Audio, please use a signal cable with ferrite core.
- Use of other cables and adapters may cause interference with radio and television reception.

## FCC Information

**⚠ WARNING:** The Federal Communications Commission does not allow any modifications or changes to the unit EXCEPT those specified by NEC Display Solutions of America, Inc. in this manual. Failure to comply with this government regulation could void your right to operate this equipment.

This equipment has been tested and found to comply with the limits for a Class B digital device, pursuant to part 15 of the FCC Rules. These limits are designed to provide reasonable protection against harmful interference in a residential installation. This equipment generates, uses and can radiate radio frequency energy, and, if not installed and used in accordance with the instructions, may cause harmful interference to radio communications. However, there is no guarantee that interference will not occur in a particular installation. If this equipment does cause harmful interference to radio or television reception, which can be determined by turning the equipment off and on, the user is encouraged to try to correct the interference by one or more of the following measures:

- Reorient or relocate the receiving antenna.
- Increase the separation between the equipment and receiver.
- Connect the equipment into an outlet on a circuit different from that to which the receiver is connected.
- Consult the dealer or an experienced radio/TV technician for help.

If necessary, the user should contact the dealer or an experienced radio/television technician for additional suggestions.

The user may find the following booklet, prepared by the Federal Communications Commission, helpful: "How to Identify and Resolve Radio-TV Interference Problems." This booklet is available from the U.S. Government Printing Office, Washington, D.C., 20402, Stock No. 004-000-00345-4.

## DECLARATION OF CONFORMITY

This device complies with Part 15 of FCC Rules. Operation is subject to the following two conditions. (1) This device may not cause harmful interference, and (2) this device must accept any interference received, including interference that may cause undesired operation.

**U.S. Responsible Party:** NEC Display Solutions of America, Inc.  
**Address:** 3250 Lacey Rd, Ste 500  
 Downers Grove, IL 60515  
**Tel. No.:** (630) 467-3000

Type of Product: Display Monitor  
 Equipment Classification: Class B Peripheral  
 Model: P754Q



## SUPPLIER'S DECLARATION OF CONFORMITY

This device complies with Part 15 of FCC Rules. Operation is subject to the following two conditions. (1) This device may not cause harmful interference, and (2) this device must accept any interference received, including interference that may cause undesired operation.

**U.S. Responsible Party:** NEC Display Solutions of America, Inc.  
**Address:** 3250 Lacey Rd, Ste 500  
 Downers Grove, IL 60515  
**Tel. No.:** (630) 467-3000

Type of Product: Display Monitor  
 Equipment Classification: Class B Peripheral  
 Model: P654Q



Windows is a registered trademark of Microsoft Corporation.

NEC is a registered trademark of NEC Corporation.

MultiSync is a trademark or registered trademark of NEC Display Solutions, Ltd. in Japan and other countries.

DisplayPort and DisplayPort Compliance Logo are trademarks owned by Video Electronics Standards Association in the United States and other countries.

All other brands and product names are trademarks or registered trademarks of their respective owners.

The terms HDMI and HDMI High-Definition Multimedia Interface, and the HDMI Logo are trademarks or registered trademarks of HDMI Licensing Administrator, Inc. in the United States and other countries.

Trademark PLink is a trademark applied for trademark rights in Japan, the United States of America and other countries and areas.

microSD and microSD SDHC logos are trademarks of SD-3C, LLC.

CRESTRON and CRESTRON ROOMVIEW are trademarks or registered trademarks of Crestron Electronics, Inc. in the United States and other countries.

Raspberry Pi is a trademark of the Raspberry Pi Foundation.

Adobe and the Adobe logo are either registered trademarks or trademarks of Adobe Systems Incorporated in the United States and/or other countries.

## GPL/LGPL Software Licenses

The product includes software licensed under GNU General Public License (GPL), GNU Lesser General Public License (LGPL), and others. For more information on each software, see "readme.pdf" inside the "about GPL&LGPL" folder on the supplied CD-ROM.



# Important Information



## WARNING



TO PREVENT FIRE OR SHOCK HAZARDS, DO NOT EXPOSE THIS UNIT TO RAIN OR MOISTURE. ALSO, DO NOT USE THIS UNIT'S POLARIZED PLUG WITH AN EXTENSION CORD RECEPTACLE OR OTHER OUTLETS UNLESS THE PRONGS CAN BE FULLY INSERTED.

REFRAIN FROM OPENING THE CABINET AS THERE ARE HIGH VOLTAGE COMPONENTS INSIDE. REFER SERVICING TO QUALIFIED SERVICE PERSONNEL.



## CAUTION



TO REDUCE THE RISK OF ELECTRIC SHOCK, MAKE SURE POWER CORD IS UNPLUGGED FROM WALL SOCKET. TO FULLY DISENGAGE THE POWER TO THE UNIT, PLEASE DISCONNECT THE POWER CORD FROM THE AC OUTLET. DO NOT REMOVE COVER (OR BACK). NO USER SERVICEABLE PARTS INSIDE. REFER SERVICING TO QUALIFIED SERVICE PERSONNEL.



This symbol warns user that uninsulated voltage within the unit may have sufficient magnitude to cause electric shock. Therefore, it is dangerous to make any kind of contact with any part inside this unit.



This symbol alerts the user that important literature concerning the operation and maintenance of this unit has been included. Therefore, it should be read carefully in order to avoid any problems.

**CAUTION:** Please use the power cord provided with this display in accordance with the table below. If a power cord is not supplied with this equipment, please contact NEC. For all other cases, please use the power cord with the plug style that matches the power socket where the monitor is located. The compatible power cord corresponds to the AC voltage of the power outlet and has been approved by, and complies with, the safety standards in the country of purchase.

This equipment is designed to be used with a power cord that has a protective earth pin connected to earth. If the power cord is not connected to the earth, it may cause electric shock. Please make sure the power cord is earthed properly.

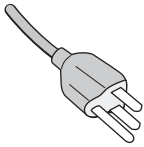
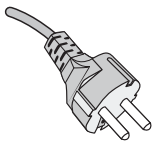
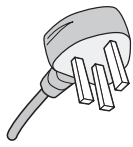
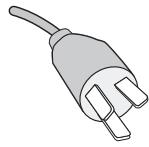
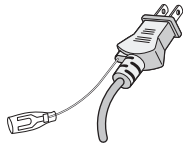
Plug Type	North America		European Continental	U.K.	Chinese	Japanese
Plug Shape						
Region	U.S.A./ Canada	Taiwan	EU	U.K.	China	Japan
Voltage	120*	110	230	230	220	100

\* When operating this monitor with its AC 125-240V power supply, use a power supply cord that matches the power supply voltage of the AC power outlet being used.

**NOTE:** This product can only be serviced in the country where it was purchased.  
Use the power cord which has BSMI mark at both ends when you use this monitor in Taiwan.

- The intended primary use of this product is as an Information Technical Equipment in an office or domestic environment.
- The product is intended to be connected to a computer and is not intended for the display of television broadcast signals.





# Safety Precautions, Maintenance & Recommended Use

## Safety Precautions and Maintenance

FOR OPTIMUM PERFORMANCE, PLEASE NOTE THE FOLLOWING WHEN SETTING UP AND USING THE MULTI-FUNCTION MONITOR:

- **DO NOT OPEN THE MONITOR.** There are no user serviceable parts inside and opening or removing covers may expose you to dangerous shock hazards or other risks. Refer all servicing to qualified service personnel.
- Do not bend, crimp or otherwise damage the power cord.
- Do not place any heavy objects on the power cord. Damage to the cord may cause shock or fire.
- The power supply cord you use must have been approved by and comply with the safety standards of your country. (e.g. Type H05VV-F 3G 0.75 mm<sup>2</sup> should be used in Europe).
- In the UK use a BS-approved power cord with a molded plug having a black (5 A) fuse installed for use with this monitor.
- The power cable connector is the primary means of detaching the system from the power supply. The monitor should be installed close to a power outlet that is easily accessible.
- Do not spill any liquids into the cabinet or use your monitor near water.
- Do not insert objects of any kind into the cabinet slots, as they may touch dangerous voltage points, which can be harmful or fatal, or may cause electric shock, fire or equipment failure.
- Do not place this product on a sloping or unstable cart, stand or table, as the monitor may fall, causing serious damage to the monitor.
- Do not mount this product upside down for an extended period of time as it may cause permanent damage to the screen.
- Do not use the monitor outdoors.
- If glass is broken, handle with care.
- This monitor is equipped with temperature control fans. For reliable performance and long life use of this product, it is required that the vents on the monitor are not covered.
- If the monitor or glass is broken, do not come in contact with the liquid crystal and handle with care.
- Allow adequate ventilation around the monitor, so that heat can properly dissipate.
- Do not block ventilated openings or place the monitor near a radiator or other heat sources.
- Do not put anything on top of the monitor.
- Handle with care when transporting. Save packaging for transporting.
- When running the cooling fan continuously, we recommend wiping clean the ventilation holes a minimum of once a month.
- To ensure the monitor's reliability, please clean the ventilation holes at the rear side of the cabinet at least once a year to remove dirt and dust.
- When using a LAN cable, do not connect to a peripheral device with wiring that might have excessive voltage.

- Do not use the monitor in high temperature, humid, dusty, or oily areas.
- Do not use the monitor under rapid changes in temperature and humidity, and avoid cold air directly from an air-conditioning vent. These conditions may shorten the life of the monitor or cause condensation. If water condensation has occurred, unplug the monitor and do not use the monitor until the condensation has evaporated.

Connecting to a TV\*

- Cable distribution system should be grounded (earthed) in accordance with ANSI/NFPA 70, the National Electrical Code (NEC), in particular Section 820.93, Grounding of Outer Conductive Shield of a Coaxial Cable.
- The screen of the coaxial cable is intended to be connected to earth in the building installation.

Under the following conditions immediately disconnect your monitor from the wall outlet and refer servicing to qualified service personnel:

- If the power supply cord or plug is damaged.
- If liquid has spilled, or objects have fallen into the monitor.
- If the monitor has been exposed to rain or water.
- If the monitor has been dropped or the cabinet has been damaged.
- If you notice any structural damage such as cracks or unnatural wobbling.
- If the monitor does not operate normally by following operating instructions.

## Recommended Use

### Ergonomics

To realize the maximum ergonomic benefits, we recommend the following:

- For the monitor's optimum performance, allow 20 minutes for warming up. Avoid reproduction of still patterns on the monitor for long periods of time to avoid image persistence (after image effects).
- Rest your eyes periodically by focusing on an object at least 5 feet away. Blink often.
- Position the monitor at a 90° angle to windows and other light sources to minimize glare and reflections.
- Adjust the monitor's brightness, contrast and sharpness controls to enhance readability.
- Get regular eye checkups.
- Use the preset Size and Position controls with standard input signals.
- Use the preset color settings.
- Use non-interlaced signals.
- Do not view the primary color blue on a dark background. It is difficult to see and may cause eye fatigue due to insufficient contrast.
- Suitable for entertainment purposes at controlled luminous environments, to avoid disturbing reflections from the screen.

\* The product you purchased may not have this feature.

**Cleaning the LCD Panel**

- When the LCD panel is dusty, please gently wipe with a soft cloth.
- Clean the LCD monitor surface with a lint-free, non-abrasive cloth. Avoid using any cleaning solution or glass cleaner!
- Please do not rub the LCD panel with a hard or abrasive material.
- Please do not apply pressure to the LCD panel surface.
- Please do not use OA cleaner as it will cause deterioration or discoloration on the LCD panel surface.

**Cleaning the Cabinet**

- Unplug the power supply.
- Gently wipe the cabinet with a soft cloth.
- To clean the cabinet, dampen the cloth with a neutral detergent and water, wipe the cabinet and follow with a dry cloth.

**NOTE:** DO NOT clean with benzene thinner, alkaline detergent, alcoholic system detergent, glass cleaner, wax, polish cleaner, soap powder, or insecticide. Rubber or vinyl should not be in contact with the cabinet for an extended period of time. These types of fluids and materials can cause the paint to deteriorate, crack or peel.

# Installation

For box contents, please refer to the printed contents sheet provided in the box.

*This device cannot be used or installed without the Tabletop Stand or other mounting accessory for support. For proper installation it is strongly recommended to use a trained, NEC authorized service person. Failure to follow NEC standard mounting procedures could result in damage to the equipment or injury to the user or installer. Product warranty does not cover damage caused by improper installation. Failure to follow these recommendations could result in voiding the warranty.*

## Mounting

### For customer:

#### ⚠ CAUTION

DO NOT mount the monitor yourself. For proper installation it is strongly recommended to use a trained, qualified technician. Please contact your supplier, as they may be able to provide a list of qualified installation professionals. Mounting on a wall or ceiling and hiring a technician is the customer's responsibility.

### Maintenance

- Periodically check for loose screws, gaps, distortions, or other problems that may occur with the mounting equipment. If a problem is detected, please refer to qualified personnel for service.
- Regularly check the mounting location for signs of damage or weakness that may occur over time.

DO NOT block ventilated openings with mounting accessories or other accessories.

### For NEC Qualified Personnel:

#### Stability Hazard.

The device may fall, causing serious personal injury or death. To prevent injury, this device must be securely attached to the floor/wall in accordance with the installation instructions.

Carefully inspect the location where the unit is to be mounted. Not all walls or ceilings are capable of supporting the weight of the unit. Weight of this monitor is mentioned in Specification (see "P654Q" on [page 72](#) and "P754Q" on [page 73](#)). Product warranty does not cover damage caused by improper installation, re-modeling, or natural disasters. Failure to comply with these recommendations could result in voiding the warranty.

To ensure safe installation, use two or more brackets to mount the unit. Mount the unit to at least two points on the installation location.

## Please note the following when mounting on wall or ceiling

#### ⚠ CAUTION

- NEC recommends mounting interfaces that comply with UL1678 standard in North America.

- NEC strongly recommends using size M8 screws (15-17 mm + thickness of bracket and washers in length). If using screws longer than 15-17 mm, check the depth of the hole. (Recommended Fasten Force: 1125 - 1375 N•cm). Bracket hole should be under  $\phi$  10 mm.

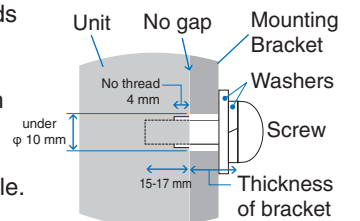

- Prior to mounting, inspect the installation location to ensure that it is strong enough to support the weight of the unit so that the unit will be safe from harm.
- For detailed information, refer to the instructions included with the mounting equipment.
- Make sure that there is no gap between the monitor and the bracket.

**NOTE:** When used in a video wall configuration for a long time, slight expansion of the monitors may happen due to temperature changes. It is recommended that over one millimeter gap is kept between adjacent monitor edges.

- ⚠ **CAUTION:**
  - When installing, do not apply pressure to the LCD panel or excessive force to any part of the monitor by pushing or leaning on it. This may cause the monitor to become distorted or damaged.
  - To prevent the monitor from falling off from the wall or ceiling, NEC strongly recommends using a safety wire.
  - Please install monitor in a spot of the wall or ceiling strong enough to support the monitor.
  - Prepare the monitor using mounting accessories such as hook, eyebolt or mounting parts and then secure the monitor with a safety wire. The safety wire must not be tight.
  - Do not attempt to hang the monitor using an installation safety wire. The monitor must be properly installed.
  - Please make sure the mounting accessories are strong enough to support the monitor before mounting it.

⚠ **CAUTION:** If you use handles for safety wire please refer to **Handles for safety wire** next page.

## Handles for safety wire

—: Factory set position.

—: Alternate position.

**Solid line:** Handle placement for safety wire in landscape position.

**Dotted line:** Handle placement for safety wire in portrait position.

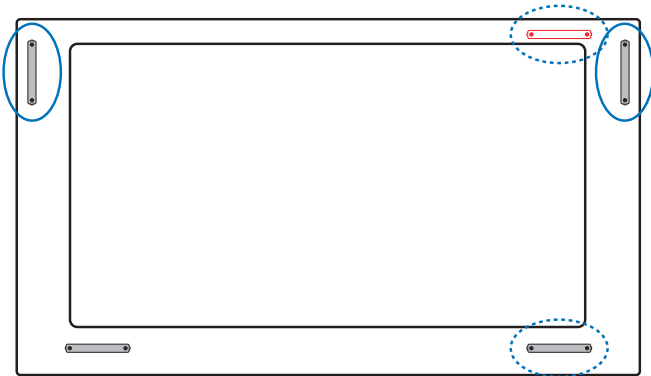

## Mounting location

- The ceiling and wall must be strong enough to support the monitor and mounting accessories.
- DO NOT install in locations where a door or gate can hit the unit.
- DO NOT install in areas where the unit will be subjected to strong vibrations and dust.
- DO NOT install the monitor next to a location where the main power supply is fed into the building.
- DO NOT install the monitor in a location where people can easily grab and hang onto the unit or the mounting equipment.
- Allow for adequate ventilation or provide air conditioning around the monitor, so that heat can properly dissipate away from the monitor and from the mounting equipment.

## Mounting on ceilings

- Ensure that the ceiling is sturdy enough to support the weight of the unit and the mounting equipment over time, against earthquakes, unexpected vibrations, and other external forces.
- Be sure the unit is mounted to a solid structure within the ceiling, such as a support beam. Secure the monitor using bolts, spring lock washers, washer and nut.
- DO NOT mount to areas that have no supporting internal structure. DO NOT use wood screws or anchor screws for mounting. DO NOT mount the unit to ceiling or to hanging fixtures.

## Maintenance

- Periodically check for loose screws, gaps, distortions, or other problems that may occur with the mounting equipment. If a problem is detected, please refer to qualified personnel for service.
- Regularly check the mounting location for signs of damage or weakness that may occur over time.

## Orientation

- When using the monitor in the portrait position, it should be rotated clockwise so that the left side is moved to the top, right side is moved to the bottom. This will allow for proper ventilation and will extend the lifetime of the monitor. Improper ventilation may shorten the lifetime of the monitor.

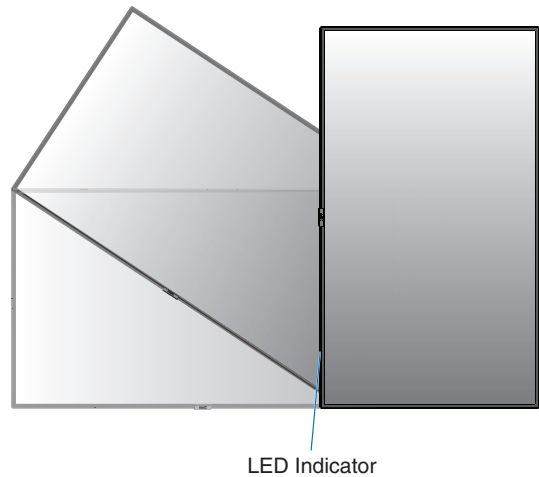

## Changing handles position

◄: Factory set position.

◄◄: Alternate position.

- ⚠ CAUTION:** Four or more handles are required when transporting. Ensure the handles are attached by the removed screws. (Recommended Fasten Force: 139 - 189 N•cm)

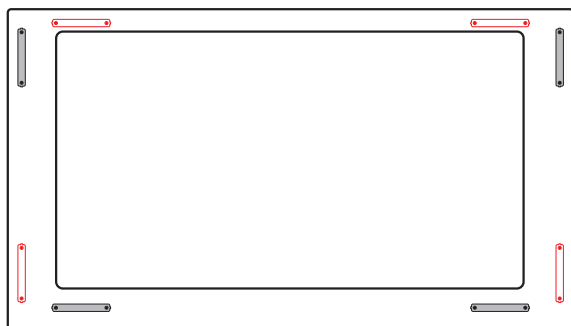

## Changing NEC logo ornament position

When using the monitor in the portrait position, the NEC logo ornament position can be changed.

Removing the logo ornament: unscrew the installed screw then take off the logo ornament.

Attaching the logo ornament: make sure the holes for the screws on the logo ornament and the holes for the screws on the bezel are aligned. Install the logo ornament with the screws, which are used for installing the logo ornament. (Recommended Fasten Force: 30-40N•cm).

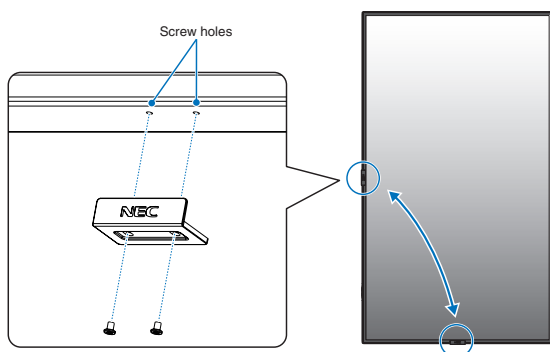

- ⚠ CAUTION:** Do not use any other screw to install the logo ornament.

## Attaching Mounting Accessories

The monitor is designed for use with the VESA mounting system.

### 1. Attach eyebolts (not included) for mounting

This model is equipped with attachable eyebolts to aid in mounting.

- Install the eyebolt brackets with the attached screws. (Recommended Fasten Force: 139 - 189 N•cm)
- Screw the eyebolts into eyebolt holes in eyebolt brackets as shown in the picture.
- Be sure eyebolts are secure.
- In order to move the monitor into position, use a lifting device attached to the eyebolts.

- ⚠ CAUTION:** **DO NOT** mount the monitor using only the eyebolts. Eyebolts are for tentative use only.

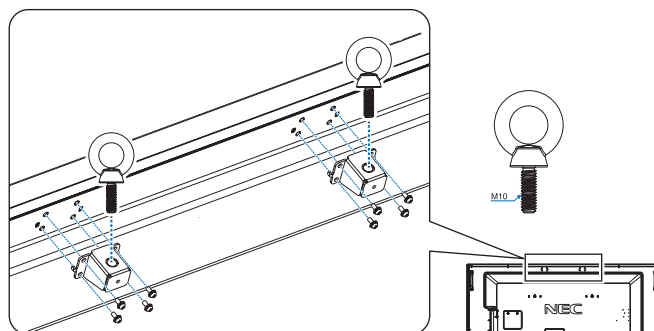

### 2. Attach Mounting Accessories

Be careful to avoid tipping the monitor when attaching accessories.

VESA Mounting Interface (M8)

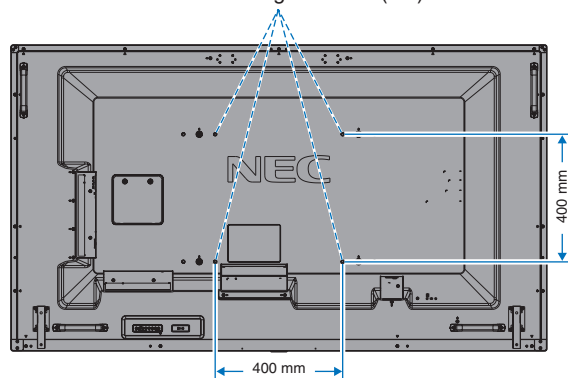

Mounting accessories can be attached with the monitor in the face down position. To avoid scratching the LCD panel, always place a soft cloth, such as a blanket that is larger than the monitor's screen area, on the table before laying the monitor face down. Make sure there is nothing on the table that can damage the monitor.

- NOTE:** Prior to installation, place the monitor face down on a flat even surface that is larger than the monitor screen. Use a sturdy table that can easily support the weight of the monitor.

- NOTE:** You can use 600 mm/400 mm holes for mounting.

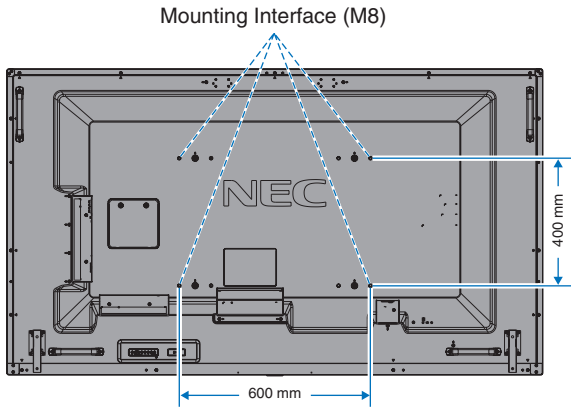

### 3. Installing an Option Board

1. Turn off the main power switch.
2. Place the monitor face down on the protective sheet.  
NOTE: Be sure to place the monitor on a flat and adequate space.
3. Remove the attached slot cover by unscrewing the installed screws (Figure 1), sliding to right (Figure 2) and moving up (Figure 3).

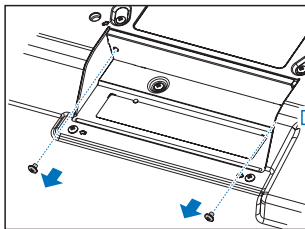
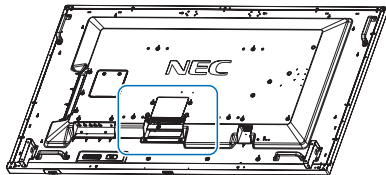

Figure 1

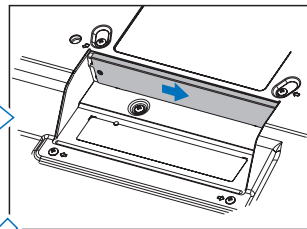

Figure 2

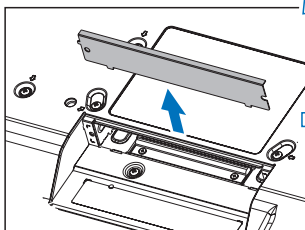

Figure 3

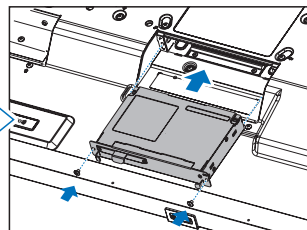

Figure 4

4. Insert the Option Board into the monitor and fix it with the removed screws (Figure 4).

**NOTE:** Please contact your supplier for a list of Option Boards available for your monitor. Do not apply excessive force to manipulate the Option Board before fixing it with screws. Make sure that the board is inserted into the slot in the correct orientation.

**CAUTION:** Ensure the Option Board is attached by the removed screws. Otherwise, the Option Board may fall out and expose you to danger.

(Recommended Fasten Force: 139 - 189N•cm).

### 4. Installing and Removing the Optional Table Top Stand

**CAUTION:** Installing and removing the stand must be done by four or more people.

For installation, follow the instructions included with the stand or mounting equipment. Use only those devices recommended by the manufacturer.

**NOTE:** ONLY use screws which are supplied with the optional table top stand.

When installing the LCD monitor stand, handle the unit with care to avoid pinching your fingers.

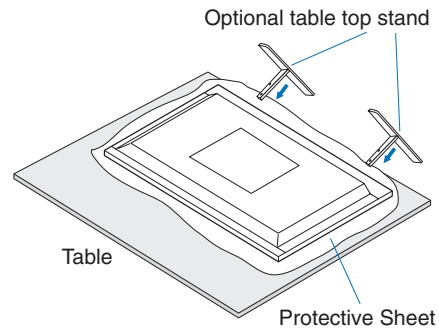

**NOTE:** Install the stand in the direction of the arrow which is imprinted on the surface of the stand. Use the ST-801.

## 5. Prevent Tipping

When using the display with the optional table top stand, fasten the LCD to a wall using a cord or chain that can support the weight of the monitor in order to prevent the monitor from falling. Fasten the cord or chain to the monitor using the provided clamps and screws that are included with the optional table top stand.

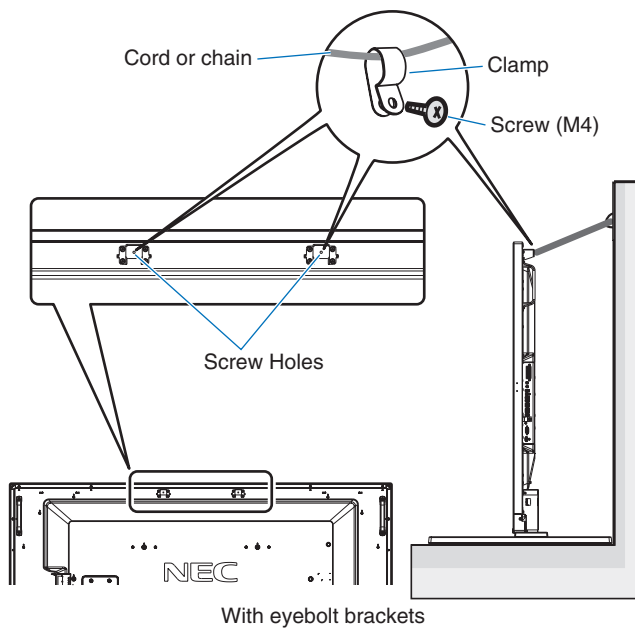
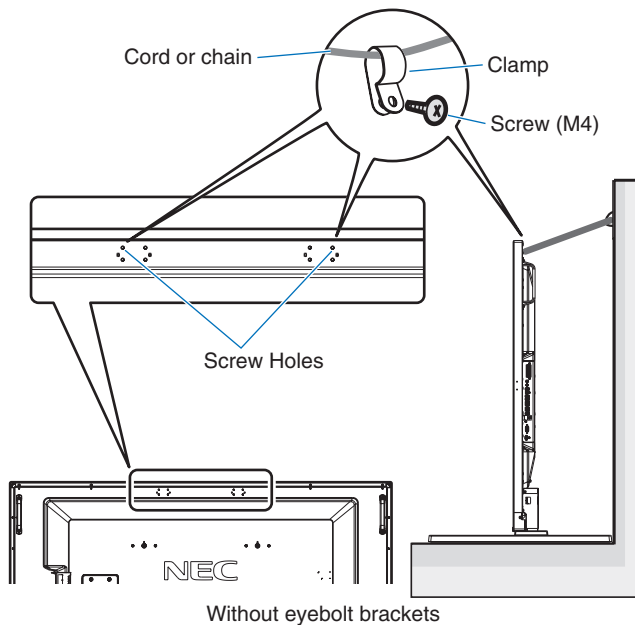

Before attaching the LCD monitor to the wall, make sure that the wall can support the weight of the monitor.

Be sure to remove the cord or chain from the wall before moving the LCD.

## 6. Ventilation Requirements

When mounting in an enclosed space or recessed area, leave adequate room between the monitor and the enclosure to allow heat to disperse, as shown below.

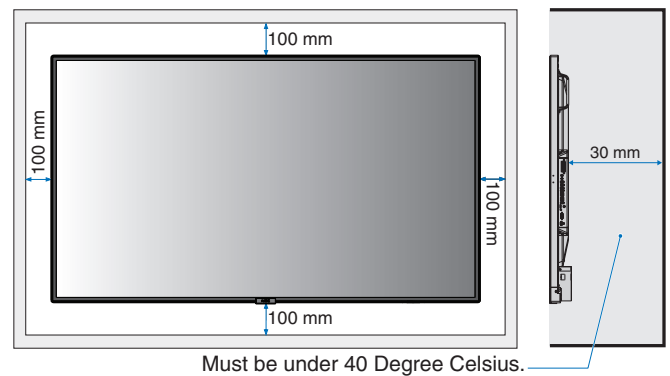

Allow adequate ventilation or provide air conditioning around the monitor, so that heat can properly dissipate away from the unit and the mounting equipment; especially when you use monitors in a multiple screen configuration.

**NOTE:** The sound quality of the internal speakers will be different depending on the acoustics of the room.



# Parts Name and Functions

## Control Panel

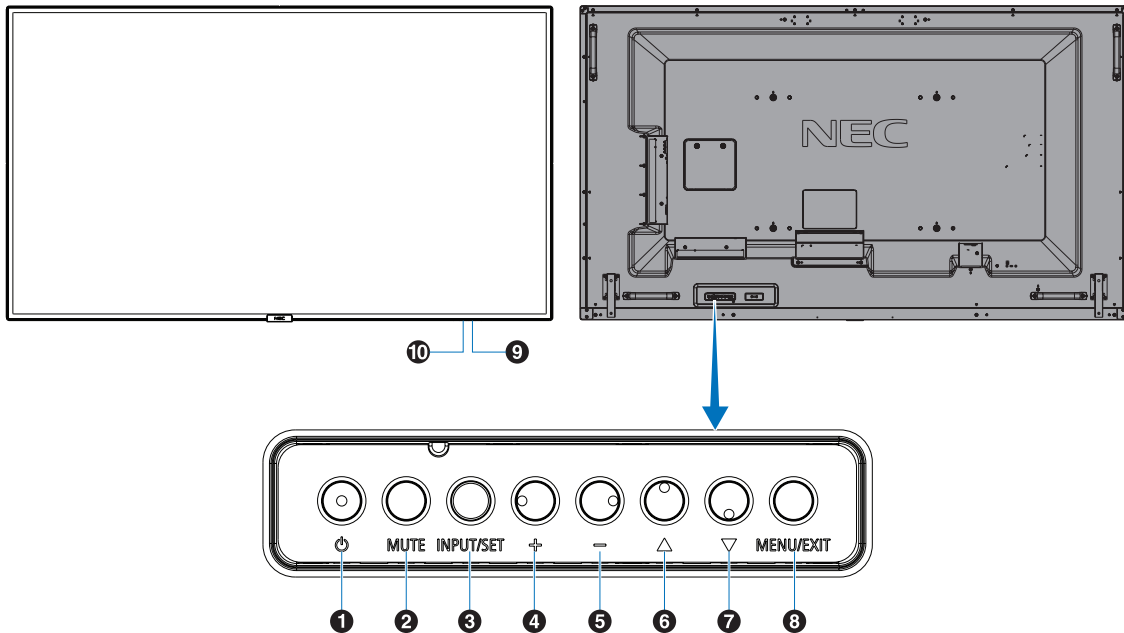

### 1 Power Button (⏻)

Switches the power on/standby. See also [page 20](#).

### 2 Mute Button (MUTE)

Switches the audio mute on/off.

### 3 Input/Set Button (INPUT/SET)

INPUT: Cycles through the available inputs when OSD menu is turned off. [DisplayPort1], [DisplayPort2], [HDMI1], [HDMI2], [HDMI3], [MP], [OPTION\*], [C MODULE]\*<sup>1</sup>. These are available inputs only, shown as their factory preset name.

**NOTE:** MP is an abbreviation of Media Player.  
SET: Acts as a “set” button when making a selection when the OSD (On Screen Display) menu is open.

\*: This function depends on which Option Board you are using.

\*<sup>1</sup>: This input is available when the optional Raspberry Pi Compute Module Interface Board and Raspberry Pi Compute Module are installed.

### 4 Plus Button (+)

Increases the audio output level when the OSD menu is turned off.

Acts to move the highlighted area to the right when navigating through the OSD menu options.

Acts as (+) to increase the adjustment of an OSD menu option after it has been selected with the SET button.

### 5 Minus Button (-)

Decreases the audio output level when the OSD menu is turned off.

Acts to move the highlighted area to the left when navigating through the OSD menu options.

Acts as (-) to decrease the adjustment of an OSD menu option after it has been selected with the SET button.

### 6 Up Button (▲)

Activates the OSD menu when the OSD menu is turned off. Acts as ▲ button to move the highlighted area up to select adjustment items within the OSD menu.

### 7 Down Button (▼)

Activates the OSD menu when the OSD menu is turned off. Acts as ▼ button to move the highlighted area down to select adjustment items within the OSD menu.

### 8 Menu/Exit Button (MENU/EXIT)

Activates the OSD menu when the OSD menu is turned off. Acts as a back button within the OSD to move to the previous OSD menu.

Acts as an EXIT button to close the OSD when on the main menu.

### 9 Remote Control Sensor and Power Indicator

Receives the signal from the remote control (when using the wireless remote control). See also [page 14](#).

Glow blue when the LCD monitor is in active mode\*.

Green and Amber blink alternately when the “SCHEDULE SETTINGS” function is enabled\*<sup>1</sup>.

When a component failure is detected within the monitor, the indicator will blink red or blink a combination of red and blue.

\* If “OFF” is selected in the “POWER INDICATOR”

(see [page 43](#)), the LED will not glow when the LCD monitor is in active mode.

\*<sup>1</sup> If “OFF” is selected in the “SCHEDULE INDICATOR” (see [page 43](#)), the LED will not blink.

**NOTE:** Please refer to the POWER INDICATOR (see [page 43](#)).

### 10 Room Light Sensing Sensor

Detects the level of ambient light, allowing the monitor to make automatic adjustments to the backlight setting, resulting in a more comfortable viewing experience. Do not cover this sensor. See [page 43](#).



## Terminal Panel

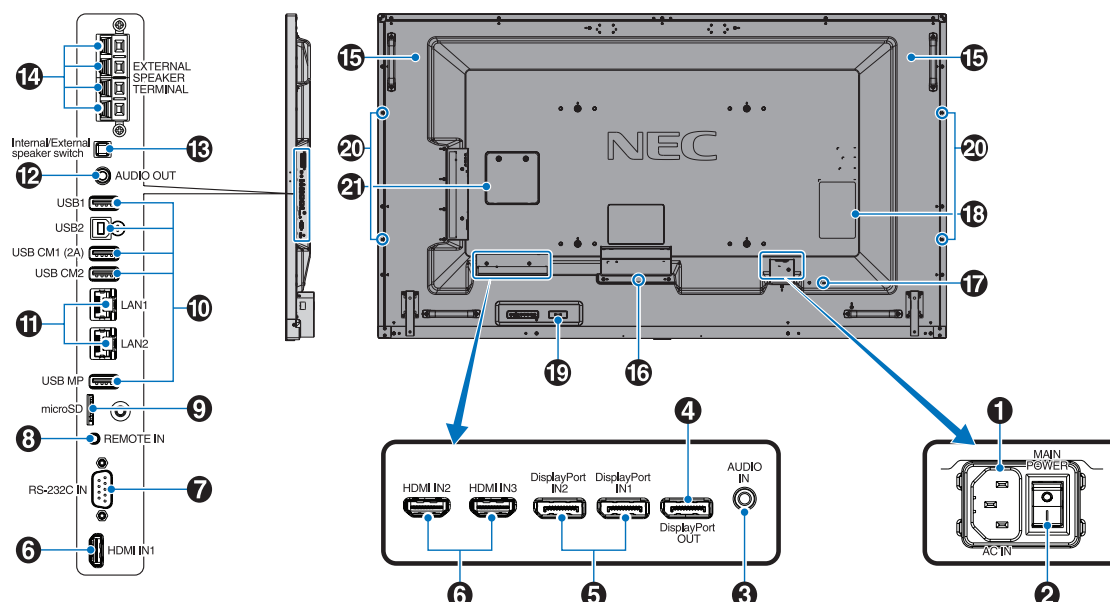

### 1 AC IN Connector

Connects with the supplied power cord.

### 2 Main Power Switch

On/Off switch to turn main power ON/OFF.

### 3 Audio IN

Audio signal input from external equipment such as a computer or player.

### 4 DisplayPort OUT

Output DisplayPort signals from DisplayPort IN1. You can connect multiple monitors by using DisplayPort daisy-chain connection. See MULTI DISPLAY (page 39) and Video out (page 68).

### 5 DisplayPort IN1/IN2

DisplayPort signals input.

### 6 HDMI IN1/IN2/IN3

Digital HDMI signals input.

### 7 RS-232C IN (D-Sub 9 pin)

Connect RS-232C input from external equipment, such as a computer, in order to control RS-232C functions.

### 8 Remote IN

Use the optional sensor unit by connecting it to your monitor.  
**NOTE:** Do not use this connector unless specified.

### 9 microSD Card Slot

microSD memory card reader for use with the Media Player (See page 23).

To install the microSD card slot cover, please refer to "Installing microSD card slot cover" (See page 23).

### 10 USB Port

USB1: Downstream port (USB Type-A).  
Connect USB devices.

USB2: Upstream port (USB Type-B).  
Connect external equipment such as a computer.

To control the monitor from connected external equipment, please use this port.

USB CM1 (2A): Power supply port.

USB CM2\*: Service port. Please do not connect devices.

\* USB functionality is available when the optional Raspberry Pi Compute Module Interface Board and Raspberry Pi Compute Module are installed.

USB MP: USB storage device reader for use with the Media Player. See page 22. This port is for future software upgrades.

To use the Media Player, please connect USB storage device to this port (See page 19).  
MP is an abbreviation of Media Player.

### 11 LAN Port 1/2 (RJ-45)

Connect to LAN in order to manage and control the monitor over the network. See page 48 and page 51.

**NOTE:** Please give priority for use to LAN1.

### 12 Audio OUT

Audio signal output from the AUDIO IN, DisplayPort and HDMI to an external device (stereo receiver, amplifier, etc.).

**NOTE:** This connector is not a Headphone terminal.

### 13 Internal/External Speaker Switch

: Internal speaker : External speaker.

**NOTE:** Please turn off the monitor's main power when you use the Internal/External speaker switch.

### 14 External Speaker Terminal

Audio signal output.

Red terminal is plus (+).

Black terminal is minus (-).

**NOTE:** This speaker terminal is for 15 W + 15 W (8 ohm) speaker.

### 15 Internal Speaker

## **16 Option Board Slot**

Slot for installation of a Slot 2 type Option Board. See [page 8](#).

**NOTE:** Please contact your supplier for a list of compatible Option Boards.

## **17 Security Slot**

Security and theft protection lock slot compatible with Kensington security cables/equipment.

For products, visit Kensington's website.

## **18 Rating Label**

## **19 Intelligent Wireless Data Sensor**

Sensor for wireless communication to the monitor for information and settings.

## **20 Option Speaker Mounting Hole**

**NOTE:** Please contact your supplier for a list of compatible speakers.

## **21 Raspberry Pi Compute Module Slot**

Slot for installing a Raspberry Pi Compute Module Interface Board and Raspberry Pi Compute Module. Please refer to <https://www.nec-display.com/dl/en/manual/raspberrypi/> for more information.

**⚠ CAUTION:** Installation must be performed by a qualified technician. Do not attempt to install a Compute Module Interface Board and Raspberry Pi Compute Module by yourself.

## Wireless Remote Control

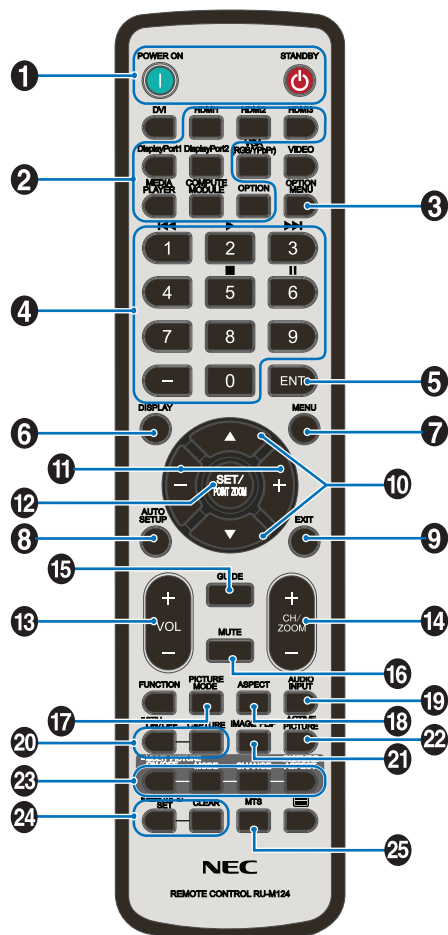

### 1 POWER ON/STANDBY Button

Switches the power on/standby.

### 2 INPUT Button

Selects the input signal.

Input signal for the MEDIA PLAYER is shown as MP.

### 3 OPTION MENU Button

### 4 KEYPAD

Press the buttons to set and change passwords, change channel and set REMOTE ID.

Below buttons are used for CEC (Consumer Electronics Control) (See [page 44](#)) and the Media Player function (See [page 22](#)): 1 ◀◀, 2 ▶▶, 3 ▶▶▶, 5 ■, 6 ||.

### 5 ENT Button

Confirm the AUTO PLAY FOLDER in Media Player.

### 6 DISPLAY Button

Turns on/off the information OSD. See [page 28](#).

If you lock remote control buttons using the IR LOCK SETTINGS function, you can unlock the buttons by holding down this DISPLAY button for more than 5 seconds.

### 7 MENU Button

Turns on/off the menu mode.

### 8 AUTO SET UP Button (This button does not work)

### 9 EXIT Button

Returns to the previous menu within the OSD menu.

### 10 UP/DOWN Button (▲/▼)

Acts as ▲ ▼ button to move the highlighted area up or down to select adjustment items within the OSD menu.

When using PIP (picture in picture), moves the small screen up or down.

### 11 MINUS/PLUS (-/+) Button

Increases or decreases the adjustment level within the OSD menu settings.

When using PIP (picture in picture), moves the small screen left or right.

### 12 SET/POINT ZOOM Button

SET: When OSD is shown, this button acts as "set button" when you make a selection.

POINT ZOOM: When OSD is not shown, this button acts as "point zoom button".

### 13 VOLUME UP/DOWN Button (VOL +/-)

Increases or decreases the audio output level.

### 14 CH/ZOOM UP/DOWN Button (CH/ZOOM +/-)\*1

Increases or decreases the POINT ZOOM level.

Please refer to POINT ZOOM (See [page 59](#)).

### 15 GUIDE Button\*1

### 16 MUTE Button

Turns on/off the mute function.

### 17 PICTURE MODE Button

Selects the picture mode, [HIGHBRIGHT], [STANDARD], [sRGB], [CINEMA], [CUSTOM1], [CUSTOM2], [SVE-(1-5) SETTINGS]. See [page 31](#).

HIGHBRIGHT: For moving images such as DVD.

STANDARD: For images.

sRGB: For text based images.

CINEMA: For movies.

CUSTOM1 and CUSTOM2: Custom setting.

SVE-(1-5) SETTINGS: For images and movies.

### 18 ASPECT Button

Selects the picture aspect, [FULL], [WIDE]\*, [DYNAMIC]\*, [1:1], [ZOOM] and [NORMAL]. See [page 21](#).

\* HDMI1, HDMI2, HDMI3 inputs only.

### 19 AUDIO INPUT Button

Selects the audio input source [IN], [HDMI1], [HDMI2], [HDMI3], [DisplayPort1], [DisplayPort2], [OPTION]\*1, [MP], [C MODULE]\*2.

### 20 STILL Button

**ON/OFF button:** Activates/deactivates still picture mode.

**CAPTURE button:** Captures still picture.

**NOTE:** This function deactivates when selecting MULTI PICTURE MODE, TEXT TICKER, SCREEN SAVER, POINT ZOOM, IMAGE FLIP except for NONE, SUPER in INPUT CHANGE, TILE MATRIX.

If input signal is OPTION, this button's actions depend on which Option Board you are using.

\*1: This button's action depends on which Option Board you are using.

\*2: This input is available when the optional Raspberry Pi Compute Module Interface Board and Raspberry Pi Compute Module are installed.

## 21 IMAGE FLIP Button

Toggle switches between [H FLIP], [V FLIP], [180° ROTATE] and [NONE]. See [page 35](#).

## 22 ACTIVE PICTURE Button

Selects active picture.

## 23 MULTI PICTURE Button

**ON/OFF Button:** Toggle switches between ON and OFF.

**MODE Button:** Selects a mode from PIP (picture in picture) or PBP (picture by picture).

**CHANGE Button:** Swaps images between two pictures.

**PICTURE ASPECT Button:** Selects active picture frame aspect.

**NOTE:** Enable to change each multi picture size by pressing SET/POINT ZOOM button during multi picture mode.

## 24 REMOTE ID Button

Activates the REMOTE ID function. See [page 47](#).

## 25 MTS Button\*1

\*1: This button's action depends on which Option Board you are using. Refer to the Option Board's user's manual for further information.

**NOTE:** The buttons with no explanation do not function.

## Operating Range for the Remote Control

Point the top of the remote control toward the monitor's remote control sensor during button operation.

Use the remote control within a distance of about 7 m (23 ft.) from the remote control sensor, or at a horizontal and vertical angle of within 30° and within a distance of about 3.5 m (10 ft.).



**Caution:** The remote control system may not function when direct sunlight or strong illumination strikes the remote control sensor, or when there is an object in the path.

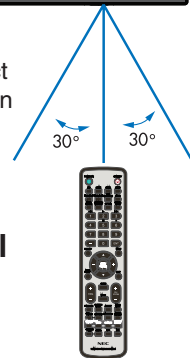

## Handling the remote control

- Do not expose to strong shock.
- Do not allow water or other liquid to splash on the remote control. If the remote control gets wet, wipe it dry immediately.
- Avoid exposure to heat and steam.
- Except to install the batteries, do not open the remote control.

# Setup

## 1. Determine the installation location

### ⚠ CAUTION

- Installing your monitor must be done by a qualified technician. Contact your supplier for more information.
- MOVING OR INSTALLING THE MONITOR MUST BE DONE BY FOUR OR MORE PEOPLE. Failure to follow this caution may result in injury if the LCD monitor falls.
- Do not mount or operate the monitor upside down.

**NOTE:** This monitor has internal temperature sensors and cooling fans, including a fan for the Option Board. If the monitor becomes too hot, the cooling fans will turn on automatically.

The Option Board's fan is active although the temperature is lower than normal operating temperature for cooling the Option Board. If the monitor becomes overheated while the cooling fan is running, a "Caution" warning appears. If the "Caution" warning appears, stop using the unit, turn off the power and allow it to cool. Using the cooling fans will reduce the likelihood of early unit failure and may help reduce image degradation and "Image Persistence".

**⚠ CAUTION:** If the monitor is used in an enclosed area or if the LCD panel is covered with a protective screen, please check the inside temperature of the monitor by using the "HEAT STATUS" control in the OSD (see [page 41](#)). If the temperature is higher than the normal operating temperature, please turn the cooling fan to ON within the FAN CONTROL menu within the OSD (see [page 41](#)).

**IMPORTANT:** To avoid scratching the LCD panel, always place a soft cloth, such as a blanket that is larger than the monitor's screen area, on the table before laying the monitor face down.

## 2. Install the remote control batteries

The remote control is powered by two 1.5V AAA batteries. To install or replace batteries:

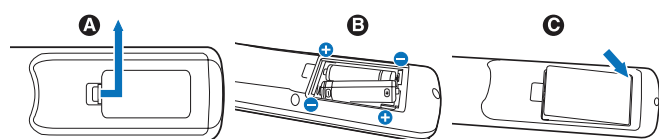

- Press and slide to open the cover.
- Align the batteries according to the (+) and (-) indications inside the case.
- Replace the cover.

**⚠ CAUTION:** Incorrect usage of batteries can result in leaks or bursting.

NEC recommends the following battery use:

- Place "AAA" size batteries matching the (+) and (-) signs on each battery to the (+) and (-) signs of the battery compartment.
- Do not mix battery brands.
- Do not combine new and old batteries. This can shorten battery life or cause liquid leakage of batteries.
- Remove dead batteries immediately to prevent battery acid from leaking into the battery compartment.
- Do not touch exposed battery acid, it may injure your skin.

**NOTE:** If you do not intend to use the Remote Control for a long period of time, remove the batteries.

## 3. Connect external equipment (See [page 17](#), [page 18](#) and [page 19](#))

- To protect the external equipment, turn off the main power before making connections.
- Refer to the user's manual of your equipment for further information.

**NOTE:** Do not connect/disconnect cables when turning on the monitor or other external equipment, as this may result in a loss of the monitor image.

## 4. Connect the supplied power cord

- The monitor should be installed close to an easily accessible power outlet.
- Fasten the power cord to the monitor by attaching the screw and clamp. (Recommended Fasten Force: 139 - 189N•cm).
- Fully insert the prongs into the power outlet socket. A loose connection may cause image instability and may pose a fire hazard.

**NOTE:** Please refer to the "Important Information" section of this user's manual for proper selection of an AC power cord.

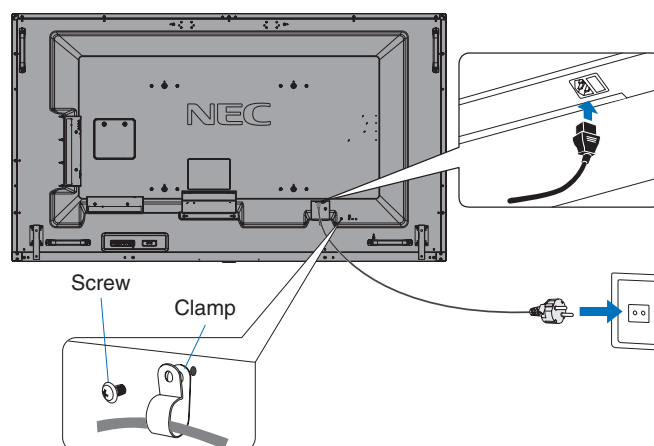

## 5. Cable information

**⚠ CAUTION:** Use the provided specified cables with this product so as not to interfere with radio and television reception.  
For USB, please use a shielded signal cable with ferrite core.  
For HDMI, DisplayPort and D-Sub 9-pin, please use a shielded signal cable.  
For Audio, please use a signal cable with ferrite core.  
Use of other cables and adapters may cause interference with radio and television reception.

## 6. Turn on the power for the external equipment and the monitor

When connected to a computer, switch on the monitor power first.

## 7. Operate the attached external equipment

Select the input source for the attached equipment to show the image signal on screen.

## 8. Adjust the sound

Make volume adjustments when required.

## 9. Adjust the picture settings (See [page 33](#))

If necessary, make adjustments to such as the backlight or contrast in the OSD PICTURE menu.

## 10. Recommended Adjustments

To reduce the risk of the "Image Persistence", please adjust the following items based on the application being used: "SCREEN SAVER", "SIDE BORDER COLOR" (See [page 41](#)), "DATE & TIME" (See [page 36](#)), "SCHEDULE SETTINGS" (See [page 36](#)).

It is recommended that the "FAN CONTROL" setting (See [page 41](#)) be checked ON also.

# Connections

**NOTE:** Do not connect or disconnect cables when turning on the monitor's main power or other external equipment's power as this may result in a loss of image.

**NOTE:** Do not use an attenuating (built-in resistor) audio cable. Use an audio cable without a built-in resistor. Using an audio cable with a built-in resistor will lower the sound level.

## Before making connections:

- \* Turn off the device's power before connecting it to the monitor.
- \* Refer to the device's user manual for available connection types and instructions for the device.
- \* We recommend turning off the monitor's main power before connecting or disconnecting a USB storage device or a microSD memory card to avoid data corruption.

## Wiring Diagram

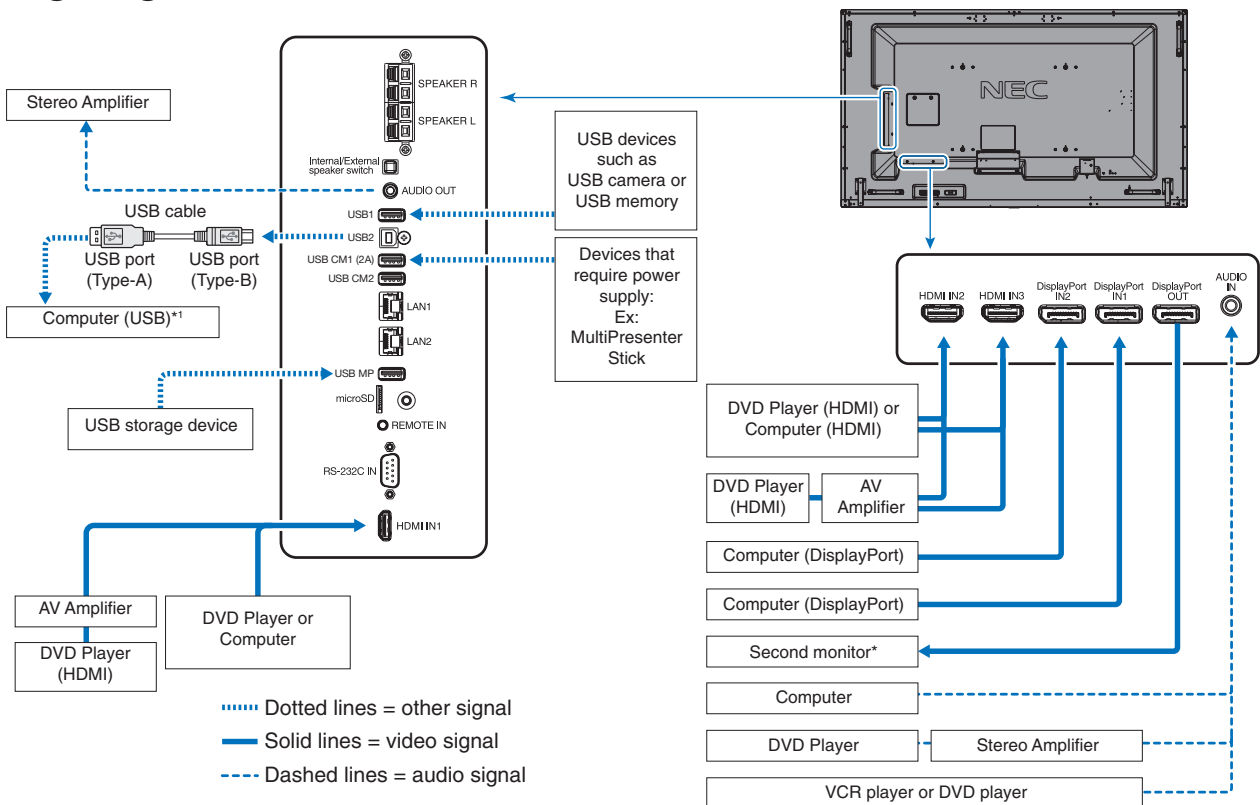

\*: Multiple monitors that are daisy-chained have a limit to the connectable monitors.  
 \*1: The device connected to USB2 can control the device connected to USB1.



## Connecting to a Personal Computer

The type of video connections that can be used to connect to a computer depends on the computer's display adapter. The following table show the typical factory preset signal timing for each connection type. Some display cards may not be able to support the required resolution for proper image reproduction with the selected connection. The monitor will show the proper image by automatically adjusting the factory preset timing signal.

<Typical factory preset signal timing>

Resolution	Scanning frequency		HDMI		DisplayPort	
	Horizontal	Vertical	MODE1	MODE2	1.1a	1.2
640 x 480	31.5 kHz	60 Hz	Yes	Yes	Yes	Yes
800 x 600	37.9 kHz	60 Hz	Yes	Yes	Yes	Yes
1024 x 768	48.4 kHz	60 Hz	Yes	Yes	Yes	Yes
1280 x 720	45.0 kHz	60 Hz	Yes	Yes	Yes	Yes
1280 x 768	47.8 kHz	60 Hz	No	No	Yes	Yes
1280 x 800	49.7 kHz	60 Hz	Yes	Yes	Yes	Yes
1280 x 1024	64 kHz	60 Hz	Yes	Yes	Yes	Yes
1360 x 768	47.7 kHz	60 Hz	No	No	Yes	Yes
1366 x 768	47.7 kHz	60 Hz	No	No	Yes	Yes
1400 x 1050	65.3 kHz	60 Hz	Yes	Yes	Yes	Yes
1440 x 900	55.9 kHz	60 Hz	Yes	Yes	Yes	Yes
1600 x 1200	75.0 kHz	60 Hz	Yes	Yes	Yes	Yes
1680 x 1050	65.3 kHz	60 Hz	Yes	Yes	Yes	Yes
1920 x 1080	67.5 kHz	60 Hz	Yes	Yes	Yes	Yes
1920 x 1200	74.6 kHz	60 Hz	Yes	Yes	Yes	Yes
1920 x 2160	133.3 kHz	60 Hz	Yes	Yes	Yes	Yes
3840 x 2160	65.7 kHz	30 Hz	No	No	Yes* <sup>1</sup>	Yes
3840 x 2160	67.5 kHz	30 Hz	Yes* <sup>1</sup>	Yes	No	No
3840 x 2160	133.3 kHz	60 Hz	No	Yes	No	Yes* <sup>1</sup> , * <sup>2</sup>
3840 x 2160	135.0 kHz	60 Hz	No	Yes* <sup>1</sup>	No	No
4096 x 2160* <sup>3</sup>	54.0 kHz	24 Hz	Yes	Yes	No	No
4096 x 2160* <sup>3</sup>	135.0 kHz	60 Hz	No	Yes	No	No

\*1: Recommended resolution.

\*2: Only HBR2 is set.

\*3: Compressed image.

## Connecting to a Player or Computer with HDMI

- Please use an HDMI cable with the HDMI logo.
- It may take a moment for the signal to appear after turning on the computer.
- Some display cards or drivers may not display an image correctly.
- When you use a computer with HDMI, please set OVER SCAN to "AUTO" or "OFF" as display drivers may not be fully compatible and may not display an image correctly (see [page 34](#)).
- To output HDMI audio, set [HDMI1], [HDMI2] or [HDMI3] at AUDIO INPUT in the OSD or choose [HDMI1], [HDMI2] or [HDMI3] by pressing the remote control AUDIO INPUT button.
- If the source signal is 3840 x 2160 (60 Hz) and 4096 x 2160 (60 Hz), please set MODE2 at HDMI in TERMINAL SETTINGS (See [page 38](#)).
- If the monitor's main power is turned on after a connected computer is turned on, sometimes an image is not displayed. In this case, please turn off the computer then turn it on again.

## Connecting to a Computer with DisplayPort

- Please use a DisplayPort cable with the DisplayPort compliance logo.
- To use the DisplayPort out connector, please refer to Video out (See [page 68](#)).
- It may take a moment for the signal to appear after turning on the computer.
- When connecting a DisplayPort cable to a component with a signal conversion adapter, an image may not appear.
- Some DisplayPort cables feature a locking function. When removing this cable, hold down the top button to release the lock.
- To output DisplayPort audio, set [DisplayPort1] or [DisplayPort2] at AUDIO INPUT in the OSD or choose [DisplayPort1] or [DisplayPort2] by the remote control AUDIO INPUT button.
- To display individual images at each connected monitors with the DisplayPort OUT connector, please set DisplayPort1.2 and MST at DisplayPort in the TERMINAL SETTINGS (See [page 38](#)).
- If the monitor's main power is turned on after a connected computer is turned on, sometimes an image is not displayed. In this case, please turn off the computer then turn it on again.



## Connecting a USB device

- USB1: USB downstream port (Type-A).  
Connect a USB compatible flash memory or keyboard to Down Stream Port.
- USB2: USB upstream port (Type-B).  
Connect to a USB compatible computer with a USB cable.  
A USB compatible computer connected to USB2 can control the devices connected to USB1.
- USB CM1 (2A): Power supply port.  
Please refer to the specifications page for power supply information (see [page 72](#) and [page 73](#)).
- USB CM2: Service port.  
Please do not connect devices.
- USB MP: USB downstream port (Type-A).  
To use the Media Player function, please use this port.

- Please make sure the connector shape and orientation is correctly aligned when connecting the USB device or cable.
- Depending on the use of computer BIOS, OS or device, the USB function may not be working. In this case, please check user's manual of your computer or device, or contact your supplier for detailed information.
- Before turning off the main power switch of the monitor or shutting down Windows®, please turn off the USB function and remove the USB cable from the monitor. You may lose data when the computer crashes.
- It may take a few seconds until the monitor recognizes the USB input. Do not disconnect the USB cable or disconnect and reconnect the USB cable before the monitor recognizes the input.
- You can set power supply for USB CM1 (2A) at USB POWER in the OSD menu (see [page 44](#)).
- When you use the USB CM1 (2A) port for power supply, please use a USB cable that supports 2A.
- Please refer to the USB in the OSD menu (See [page 44](#)) for the USB setting.

**NOTE:** USB CM1 (2A) and USB CM2 are not corresponding port.  
Please refer to the connection (See [page 17](#)) to connect USB devices to the monitor.

**⚠ CAUTION:** Do not bind the USB cable. It may trap heat and start a fire.

# Basic Operation

## Power ON and OFF Modes

Press the power button on the Control Panel or Remote Control to turn on the monitor.

**NOTE:** The Main Power switch must be in the ON position in order to power up the monitor using the remote control or the Power button on the Control Panel.

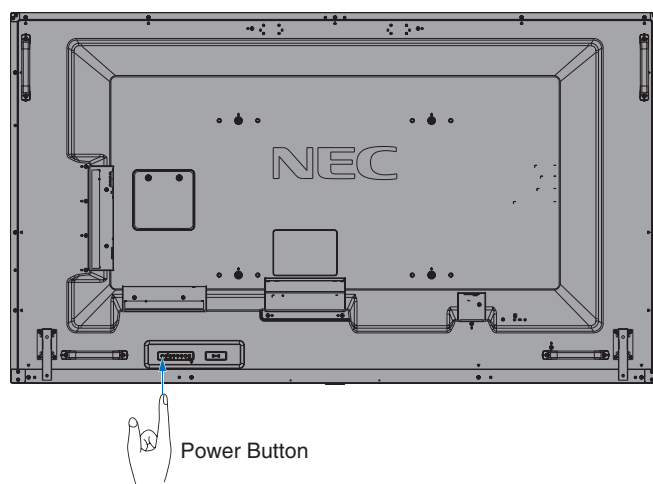
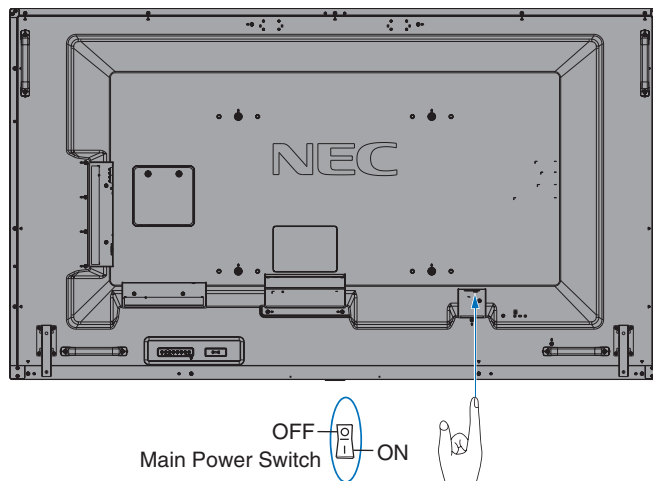

Using the remote control

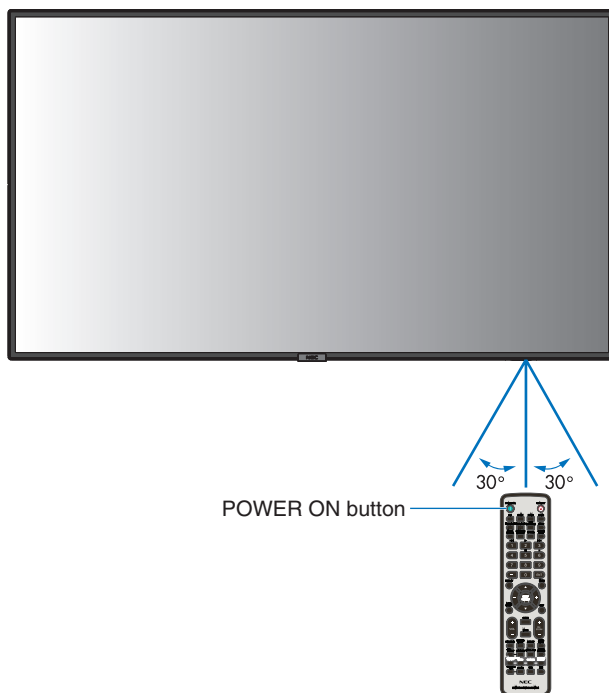

## Power Indicator

LED indicator status and lighting pattern	Condition	Recovery
Glowing blue	Normal	
Blinking green*1	Under any of the conditions below, no input signal has been detected by the monitor during the period of time you set: <ul style="list-style-type: none"> <li>The monitor is using an Option Board.</li> <li>INPUT DETECT is set to a setting except for NONE.</li> <li>USB POWER is set to ON.</li> <li>DisplayPort in the TERMINAL SETTINGS is set to MST.</li> </ul>	1. Turn on the monitor by the remote control or the monitor button.  2. Send an AV signal input to the monitor.
Glowing amber	No AV signal input has been detected by the monitor during the period of time you set. (with network signal input)	
Blinking amber	No AV signal input has been detected by the monitor during the period of time you set. (no network signal input)	
Glowing red	Turn off the monitor by the remote control or the monitor button.	Turn on the monitor by the remote control or the monitor button.

\*1: Time setting for AUTO POWER SAVE is available at POWER SAVE (See page 41).

**NOTE:** If the indicator is blinking red in a combination of long and short, a certain failure might have occurred, please contact your supplier.

## Using Power Management

This monitor follows the VESA approved DPM (Display Power Management) function. The power management function is an energy saving function that automatically reduces the power consumption of the monitor when the keyboard or the mouse has not been used for a fixed period. This allows your monitor to enter a Power Management mode if the monitor's POWER SAVE function is set to ENABLE, and a certain amount of time has passed since the monitor recognized "no signal input". It will increase the life and decrease the power consumption of the monitor.

**NOTE:** Depending on the computer and display card used, this function may not operate. After the video signal was lost, the monitor automatically goes into OFF at a preset time period.

## Aspect

For MP (Media Player)  
 FULL → ZOOM → NORMAL  
 ↑  
 For DisplayPort1, DisplayPort2, OPTION\*1  
 FULL → 1:1 → ZOOM → NORMAL  
 ↑  
 For HDMI1, HDMI2, HDMI3  
 FULL → WIDE → DYNAMIC → 1:1 → ZOOM → NORMAL  
 ↑

\*1: This function depends on which Option Board you are using.

Aspect ratio of image	Unchanged view*3	Recommended selection for picture aspect*3
4:3		NORMAL
		DYNAMIC
Squeeze		FULL
Letterbox		WIDE

\*3 Grey areas indicate unused portions of the screen.

**NORMAL:** Reproduces the aspect ratio that is sent from the source.  
**FULL:** Fills the entire screen.  
**WIDE:** Expands a 16:9 letterbox signal to fill the entire screen.  
**DYNAMIC:** Expands a 4:3 pictures to fill the entire screen with non-linearity. Some of the outside image area will be cut off due to expansion.  
**1:1:** Shows the image in a 1 by 1 pixel format.

**ZOOM**  
 The image can be expanded beyond the active screen area. The parts of the image outside the active screen area are not shown.

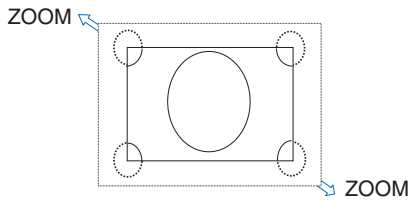

# Media Player

Plays saved data, such as still and motion images, BGM (Background Music), on a USB storage device or microSD memory card connected to the monitor.

## Top screen of the viewer

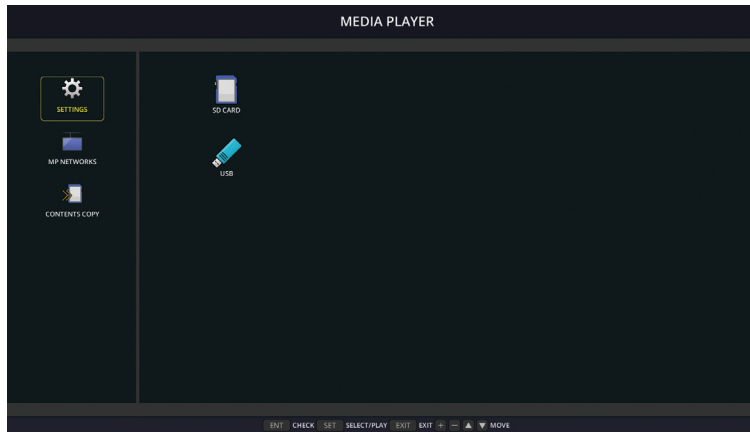

- Select [SETTINGS] to change the media player settings.
- While “AUTO PLAY” has been set to SLIDESHOW in SETTINGS, the monitor starts performing “AUTO PLAY” by the operation below:
  - When connecting a USB storage device to the USB MP (Terminal Panel [page 11](#)), with the monitor already powered ON and the Media Player top screen displayed.
  - When the input signal is changed to MP, with a USB storage device already connected to the USB (2A) port of the monitor.

For starting “AUTO PLAY”, the system will automatically search the folder which is set in the AUTO PLAY settings FOLDER field, in the USB storage device and then display found still images or movies. The images and movies will be displayed in the “Sorted” order.

**NOTE:** Only 1 USB storage device can be recognized by the viewer.

A window will appear when you press the control panel buttons while the Media Player is active. You can select to control either the OSD menu or the Media Player from the window that opens.

If Media Player contents are played while TILE MATRIX is active, the image play timing might have a gap within monitors.

If a monitor is used in portrait position, please set OSD ROTATION to PORTRAIT. Image orientation is changed according to what you set at OSD ROTATION.

When OSD ROTATION is set to PORTRAIT, please use the motion image, which is rotated anticlockwise by 90°.

## Displayable/playable files

### Still

#### Supported formats

File extension	Supported
.jpg, .jpeg, .jpe	Baseline, Progressive, RGB, CMYK
.png	Interlace, $\alpha$ channel

### Motion image

#### Supported formats

File extension	Video codec	Audio codec
.mpg, .mpeg	MPEG1, MPEG2	MPEG Audio Layer3 (Abbreviation: MP3) AAC-LC (Abbreviation: AAC), LPCM
.wmv	H.264, WMV	MP3, WMV Standard, WMA 9/10 Professional
.mp4	H.264	MP3, AAC
.mov	H.264	MP3, AAC
.flv, .f4v	H.264	MP3, AAC

**BGM**

**Supported formats**

File extension	Audio codec
.wav	LPCM
.mp3	MP3

**Information**

Item	Conditions	
Resolution	JPEG	5000x5000
	PNG	4000x4000
	MPEG1	480@30fps
	MPEG2	MP@ML, MP@HL, 1080p@30fps / 1080i@60fps
	H.264	High profile Lv.4.2, 1080p@30fps / 1080i@60fps
	WMV	Advanced@L3, Simple&Main
Video bit date	-	Up to 15Mbps
Audio sampling rate	-	Up to 48KHz
Audio bit rate	MP2	Up to 384Kbps
	MP3	Up to 320Kbps
	AAC	Up to 1440Kbps

**NOTE:** Depending on the file, it may not play even when it satisfies all above mentioned conditions.  
 Depending on network environments, the type of USB storage device, and file bitrate, it may not play still image files.  
 You cannot play DRM (Digital Right Management) files.  
 The maximum resolution for a motion image is 1920 (Horizontal) x 1080 (Vertical).

**Compatible microSD memory card**

Format a microSD memory card in the FAT32 format or FAT16 format.  
 Refer to the computer's instruction user's manual or Help file on how to format a microSD memory card.

**Information**

Up to 32GB microSDHC is supported.

**NOTE:** The monitor is not guaranteed to work with all microSD memory card sold commercially.  
 microSD with CPRM is not supported.  
 microSD UHS-1 or UHS-2 are not supported.

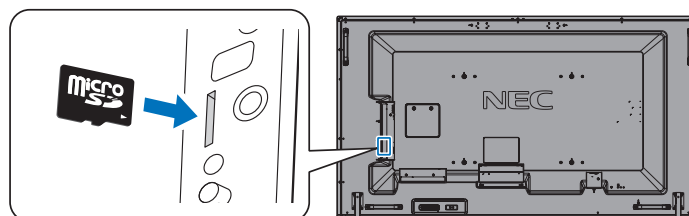

- When inserting a microSD memory card, please make sure of the microSD memory card is in the correct direction then insert it. Fully insert the microSD memory card and press in unit the spring lock is engaged.
- When ejecting a microSD memory card from the microSD card slot, press the center of the microSD memory card to release the spring lock, then take it out.

**Installing microSD card slot cover**

To secure your microSD memory card, we recommend you to install the microSD card slot cover.  
 Please insert the edge of the microSD card cover to the hole. Secure it in place with the provided screw.  
 (Recommended Fasten Force: 139 - 189N•cm).

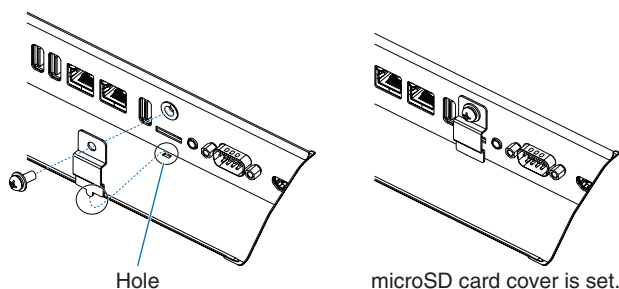

**Connect compatible USB storage device**

Format a USB memory in the FAT32 format or FAT16 format to use it with the Media Player. Refer to the computer’s instruction user’s manual or Help file on how to format a USB storage device.

Please use a USB storage device with this monitor in accordance with the drawing below. If the physical size of the USB storage device is larger than the supported sizes listed below, please use a USB extension cable.

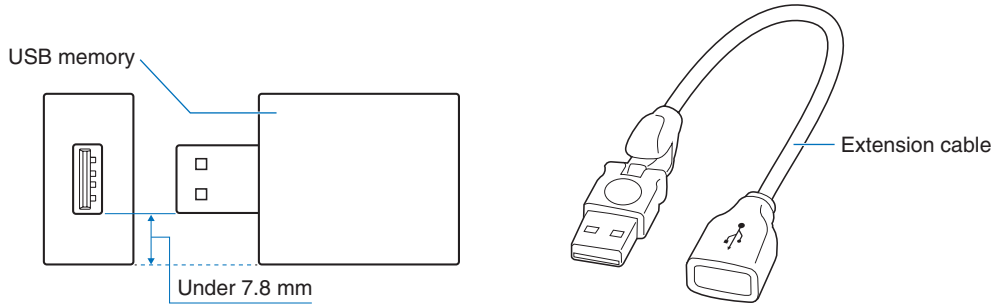

**NOTE:** If the monitor does not recognize a connected USB storage device, make sure the file structure is FAT32 or FAT16. It is not guaranteed to work with all USB memories sold commercially. Please connect the USB memory to USB MP (See [page 19](#)).

**File display screen**

The files can be displayed using either icons or thumbnails in the Media Player.

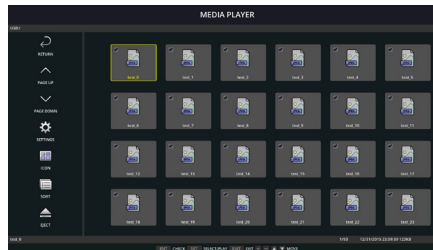

**Icon display**

	RETURN	Goes back one level higher.
	PAGE UP	Displays a list of the previous files.
	PAGE DOWN	Displays a list of the next files.
	SETTINGS	Displays the setting screen.
	THUMBNAILS/ICON	Switches between thumbnail display and icon display.
	SORT	Changes the order to display files by name (filename), type (file extension), date (date of creation), or size (file capacity). The default sorting order is by "Name".
	EJECT	Disconnects from the USB storage device or the microSD memory card inserted to the monitor. Please select EJECT when file list is displayed.

**NOTE:** The maximum number of files that can be displayed in a folder including folder icons is 300. A folder hierarchy is shown up to level 16. The icon of a file whose type cannot be determined is indicated by a “?”. Depending on the file, thumbnail cannot be displayed.

## Slideshow display

- Select a folder that contains images or movies.
- A slideshow can be displayed using “MANUAL” in which the images are switched by operating a button on the remote control, or “AUTO” in which the images are switched automatically at a set interval (PLAY MODE is “AUTO”).
- The default factory setting is “MANUAL”. To perform “AUTO”, set the “PLAY MODE” to “AUTO”.
- The images will be displayed in the order selected under “Sort” on the file display screen.
- When still images in high resolutions are displayed as the Slideshow, it may go back to the file display screen.

## Media Player settings

Select the  icon in the file list screen or top screen of the Media Player to display the configuration screen of the Media Player.

The following settings can be configured on the configuration screen.

### SLIDESHOW

Menu	Function
SCREEN SIZE	Selects ACTUAL SIZE or BEST FIT.
PLAY MODE	Selects AUTO or MANUAL.
INTERVAL	Sets interval time.
REPEAT	Check the check box to repeat slideshow.
AUDIO FILE	Selects an audio file.
BGM	Check the check box to enable BGM.
PLAY END SCREEN	Selects a setting for when the slideshow finishes.
	BLACK SCREEN: When the slideshow finishes, a black screen is displayed.
	FILE LIST: When the slideshow finishes, it goes back to the file list screen.
	SAVE LAST SCREEN: When the slideshow finishes, the last slideshow image is kept on the screen.

### AUTO PLAY

Automatically displays selected folder when the input signal is changed to MP, while “AUTO PLAY” has been set to SLIDESHOW.

Menu	Function
AUTO PLAY	OFF: Automatic play mode is off.
	SLIDESHOW: Automatically plays a selected file.
FOLDER	Select a file by SET/POINT ZOOM button and confirm by ENT button.

### PRESET CONTENTS

Plays selected folder when the monitor has no signal input.

Menu	Function
ENABLE	Check the check box to enable preset contents.
FOLDER	Select a file by SET/POINT ZOOM button and confirm by ENT button.

Please press OK to activate above settings.

If OK is not pressed, settings that you set are not activated.

# NETWORK & OTHER SETTINGS

The settings below are the options for the Network settings and Shared Folder settings for the Media Player.

To configure the settings, press the remote control SET/POINT ZOOM button on the NETWORK & OTHER SETTINGS.

## NETWORK SETTINGS for MEDIA PLAYER

Menu	Function
IP SETTING	Set these settings.
IP ADDRESS	
SUBNET MASK	
DEFAULT GATEWAY	
DNS	
DNS PRIMARY	
DNS SECONDARY	

NETWORK INFORMATION for the Media Player displays what you set in the NETWORK SETTINGS for the Media Player.

## SHARED FOLDER

There are two settings for configuring the SHARED FOLDER.

Press the remote control SET/ZOOM button to open the shared settings options.

- SHARED SD CARD SETTINGS  
Folders saved in a computer on the network can be copied to the connected microSD memory card using a web browser on the connected computer.

Menu	Function
ENABLE	Check the checkbox to enable SHARED SD CARD SETTINGS.
USER NAME	USER NAME is displayed. It is the same name as the monitor name and it is not changeable.
PASSWORD	Set password.

Please press OK to activate settings in the SHARED SD CARD SETTINGS.

If OK is not pressed, settings that you set are not activated.

- SHARED FOLDER SETTINGS.  
Folders saved in a computer on the network can be copied to the connected microSD memory card by controlling the monitor.

Menu	Function
ENABLE	Check the checkbox to enable SHARED FOLDER SETTINGS.
SHARED FOLDER	Set the IP address of the network shared folder location that contains the files for copying to the microSD card.
USER NAME	Set USER NAME which is used when connecting the monitor to the shared folder.
PASSWORD	Set password.

Please press OK to activate settings in the SHARED FOLDER SETTINGS.

If OK is not pressed, settings that you set are not activated.

1 to 4 shared folders can be set.

When the connection to the shared folder fails, an error message is displayed and an “x” is displayed in the folder icon.



Carry out the following checks in this case.

- Is the name of the destination folder correct?
- Is the destination folder set for sharing?
- Have access rights been set in the destination folder?
- Are there any displayable files saved in the destination folder?

## SHIFT NO SIGNAL

This setting is for a situation when the monitor detects no signal input. If ENEBLE is ticked, the monitor goes to no signal status.

The monitor detects no signal when the monitor is in the following conditions:

- After contents or images are played.
- While the monitor is displaying USB  window or SD CARD  window.

Menu	Function
ENABLE	Check the checkbox to enable SHIFT NO SIGNAL.
INTERVAL	Set the time when the monitor goes into no signal after displayed detected items.

Please press OK to activate settings in the SHIFT NO SIGNAL.

If OK is not pressed, settings that you set are not activated.



## Using SHARED SD card SETTINGS

You can copy data to the microSD memory card, such as motion or still images, from a computer connected to the same network as the monitor.

Please set the NETWORK SETTINGS for the Media Player (See [page 26](#)) first to copy data.

**NOTE:** When the monitor is copying a folder, the LED indicator blinks in red. When the monitor is in this condition, do not eject a microSD memory card from the monitor and do not turn off the monitor's main power. Ejecting the microSD card or turning off the monitor while copying files may corrupt the data. If you press the STANDBY button on the remote control or the POWER button on the monitor while the LED indicator is blinking in red, the monitor goes into standby after completing the folder copy. Files which you can copy are still, motion image and BGM only.

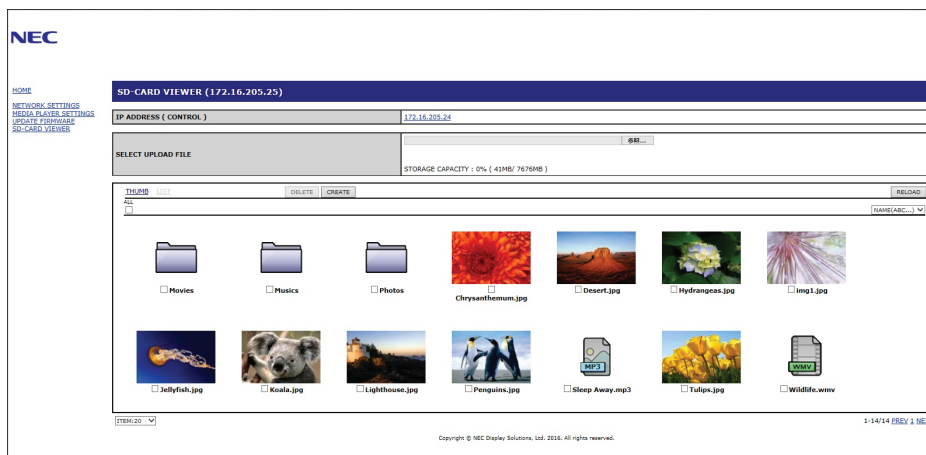

### Setting procedure

1. Open the Monitor LAN control of the network connected monitor then select SD-CARD VIEWER.
2. Select SEARCH to display the IP ADDRESS of the currently connected monitor and all compatible monitors on the same network.
3. Select the IP ADDRESS of the currently connected monitor.
4. Enable upload, delete and sort files that are saved in the microSD memory card connected to the monitor.

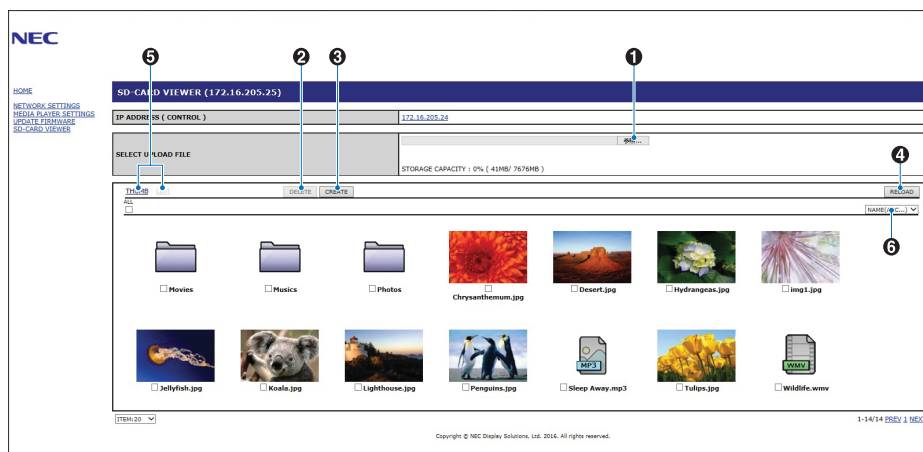

### Function

#### 1. SELECT UPLOAD.

Press SELECT then choose the files to be copied to the microSD memory card.

File upload window appears and shows the selected files.

Once OK is selected, file uploading starts.

**NOTE:** Please check the microSD memory card storage capacity before copying files. STORAGE CAPACITY shows the connected microSD memory card capacity.

#### 2. DELETE.

Select files or folders.

DELETE FOLDERS/FILES window appears.

Once OK is selected, the selected files or folders are deleted.

#### 3. CREATE.

A new folder is created in the microSD memory card connected to the monitor.

Insert folder name and select OK. A maximum of 255 alphanumeric characters is allowed.

4. RELOAD.  
Updates microSD memory card data.
5. THUMB/LIST.  
The files can be displayed using either icons or thumbnails.  
Displays description of the file or folder if you select thumb name or file name.
6. SORT.  
Select sort type. The folders saved in the microSD are sorted based on what you selected in sort type.

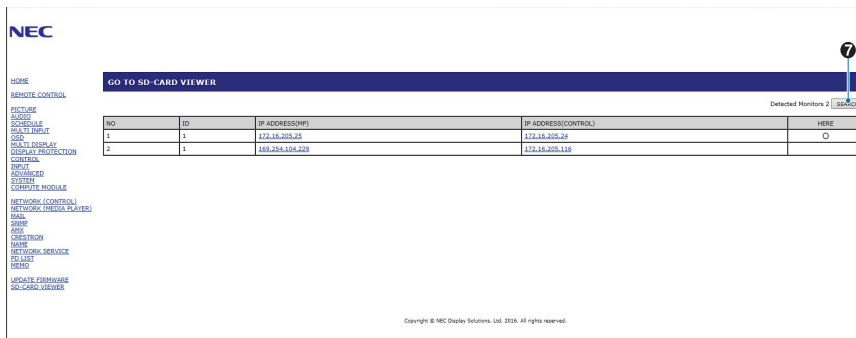

7. Connect to the other monitor's SD-CARD VIEWER then open them.  
By running the SEARCH, as described on the previous page, this window shows all compatible monitors on the same network as the current monitor.  
To open the other monitor's web page in a new tab, right-click on its IP address. To open the other monitor's web page in a new window, left-click on its IP address

## Using CONTENTS COPY

You can copy all data saved in a USB storage device or saved in a shared folder, which is set in the connected computer or a server, to a microSD memory card.

For copying shared folder data, please set SHARED FOLDER SETTINGS (See [page 26](#)) first.

1. Select CONTENTS COPY at the top screen of the Media Player.
2. Select a USB storage device or a folder.
3. Select OK to start copying. All data saved in the folder or device is copied to the microSD memory card and the original data saved in the microSD memory card is deleted.

**NOTE:** "Out of disk space" is displayed if the microSD memory card storage capacity is not enough to copy selected folders. When contents copy has occurred, previous data that was saved in the microSD memory card is deleted. Only devices connected to the monitor are shown. When the monitor is copying a folder, the LED indicator blinks in red. When the monitor is in this condition, do not eject the microSD memory card from the monitor and do not turn off the monitor's main power. Ejecting the microSD card or turning off the monitor while copying files may corrupt the data. If you press the STANDBY button on the remote control or the POWER button on the monitor while the LED indicator is blinking in red, the monitor goes to standby after completing the folder copy.

## Using Emergency contents

In case of emergency sends a command to the monitor, from a computer connected to the monitor, to play the emergency contents folder. Please create an EMERGENCY CONTENTS folder as a root folder in the microSD memory card that is connected to the monitor.

Instructions for the EMERGENCY CONTENTS can be found on the CD included with the monitor. The file is called "External\_control.pdf".

## Information OSD

The Information OSD provides information such as: Input Source, Picture Size, IP Address, Monitor ID, etc. Press the DISPLAY button on the remote to bring up the Information OSD.

MONITOR ID: 1  
IP ADDRESS: 192.168.0.10

DisplayPort1  
AUDIO: IN  
ASPECT: FULL  
1920 X 1080  
67.5 kHz/60 Hz

HDMI2  
1920 X 1080  
67.5 kHz/60 Hz

① Input name

② Audio input name

③ Picture aspect

④ Input Signal Information

⑤ Multi picture information

⑥ Communication Info

# Picture Mode

Depending on the setting of SPECTRAVIEW ENGINE in the OSD PICTURE menu (see page 35), the selection choices for the Picture Mode are different.

## SPECTRAVIEW ENGINE is set to “ON”:

Select from five different picture modes, either via the OSD menu item PICTURE MODE or using the PICTURE MODE button on the wireless remote control.

### Select the Picture Mode with the wireless remote control

By pressing the Picture Mode button, the picture mode changes.



### Select or change the Picture Mode in the OSD menu item PICTURE MODE

Select a setting from SVE-1 SETTING to SVE-5 SETTING at PICTURE MODE. Select a preset item at PRESET.

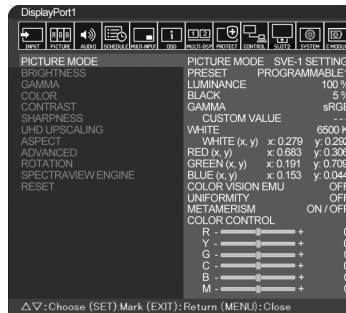

Choose the Picture Mode that is most suitable for the type of content that is shown.

- Several modes are selectable (sRGB, Adobe®RGB SIM., eciRGB\_v2 SIM., DCI SIM., REC-Bt709, HIGH BRIGHT, FULL, DICOM SIM, PROGRAMMABLE).
- Each PICTURE MODE includes LUMINANCE, WHITE, GAMMA, BLACK, RED, GREEN, BLUE, COLOR VISION EMU, UNIFORMITY and METAMERISM settings.

### PRESET Types

PRESET	PURPOSE
sRGB	The standard color setting used for the Internet, Windows® operating systems, many smart-phones and other digital cameras. Recommended setting for general color management.
Adobe®RGB SIM.	Provides a standard color space used in high-end graphics applications such as professional digital still cameras and imaging.
eciRGB_v2 SIM.	Color setting recommended by ECI (The European Color Initiative).
DCI SIM.	Color setting for digital cinema.
REC-Bt709	Color setting for High-definition television.
HIGH BRIGHT	Highest brightness setting.
FULL	Native LCD panel color gamut. Suitable for use with color managed applications.
DICOM SIM.	Setting that conforms to the DICOM standard for the Grayscale Standard Display Function.
PROGRAMMABLE	For the Hardware Calibration by NEC Display Solutions GammaCompMD QA software (some OSD settings are disabled).

MODE	PURPOSE
LUMINANCE	Adjusts the overall image and screen background luminance.
WHITE	Adjusts the white color by temperature or x, y setting. A lower color temperature will result in a reddish screen and a higher color temperature in a bluish screen. A larger x value will result in a reddish screen, a larger y value changes the screen to greenish, and smaller x,y values will change the screen to bluish white.

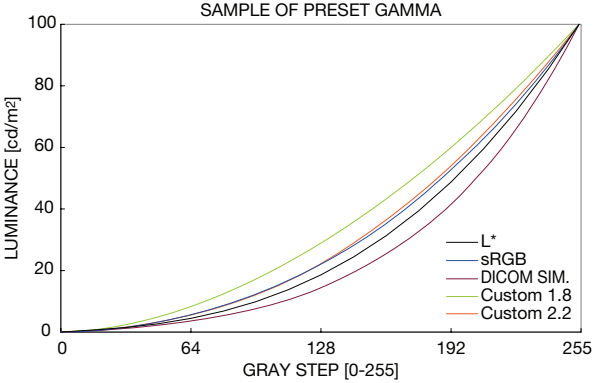
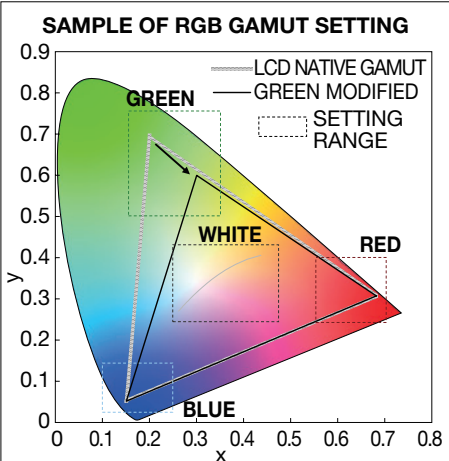
<p>GAMMA</p>	<p>Allows you to manually select the brightness level of grayscale. There are five selections: sRGB, L STAR, DICOM SIM. and CST. We recommend to show grayscale image data on screen.</p> <p>sRGB: GAMMA setting for sRGB.</p> <p>L STAR: GAMMA setting for the CIELAB color space Lab.</p> <p>DICOM SIM.: DICOM GSDF (Grayscale Standard Display Function) is typically used for medical imaging.</p> <p>CST: CUSTOM VALUE can be adjusted when CST is selected as the GAMMA SELECTION setting.</p> <p>CUSTOM VALUE: The gamma value is selected from the range from 0.5 to 4.0 in 0.1 steps.</p> 
<p>BLACK</p>	<p>Adjusts the black luminance.</p>
<p>RED GREEN BLUE</p>	<p>Adjusts the color gamut.</p> 
<p>COLOR VISION EMU</p>	<p>Previews various typical human vision deficiencies and is useful for evaluating how people who have such deficiencies will perceive colors. This preview is available in four modes: Types P (Protanopia), D (Deuteranopia) and T (Tritanopia) emulate color vision dichromacy, and Grayscale can be used for evaluating contrast legibility.</p> <p>NOTE: Depending on the vision of the user, including those with color vision deficiency, there will be a variation in how the screen's color is seen and experienced.</p> <p>A simulation is used to illustrate the view of those with a color vision deficiency. It is not their actual view. The simulation is a reproduction of those with a strong color vision mode of type P, type D or type T. People with a slight color vision deficiency will experience little to no difference compared to those with normal color vision.</p>
<p>UNIFORMITY</p>	<p>This function electronically compensates the slight variations in the white uniformity level as well as deviations in color that may occur throughout the screen area. These variations are characteristic of LCD panel technology. This function improves the color reproduction and evens out the non-uniformity in luminance of the monitor.</p> <p>NOTE: A higher number produces a better effect, but may also reduce the contrast ratio.</p>
<p>METAMERISM</p>	<p>Compensates the visual color difference with other monitors.</p> <p>If you prefer to get the color reproduction to be closer to the Picture Mode setting, set this function to OFF.</p>

- NOTE:**
- When the selected PICTURE MODE is different from your computer's ICC color profile, you may experience inaccurate color reproduction.
  - MultiProfiler software, developed by NEC Display Solutions, is highly recommended to provide extended color management features such as ICC profile Emulation and Printer Emulation. The latest MultiProfiler software is available on the NEC Display Solutions website.

**SPECTRAVIEW ENGINE is set to “OFF”:**

Select from five different picture modes, either via the OSD menu item PICTURE MODE or using the PICTURE MODE button on the wireless remote control.

For DisplayPort1, DisplayPort2, OPTION\*, HDMI1, HDMI2, C MODULE\*<sup>2</sup>

STANDARD → sRGB → CINEMA → CUSTOM1 → CUSTOM2 → HIGHBRIGHT



\*: This function depends on which Option Board you are using.

\*<sup>2</sup>: This input is available when the optional Raspberry Pi Compute Module Interface Board and Raspberry Pi Compute Module are installed.

For MP

STANDARD → CINEMA → CUSTOM1 → CUSTOM2 → HIGHBRIGHT

**PRESET types**

PRESET	PURPOSE
<b>HIGH BRIGHT</b>	Highest brightness setting.
<b>STANDARD</b>	Standard setting.
<b>sRGB</b>	The standard color space used for the Internet, Windows® operating systems and digital cameras. Recommended setting for general color management.
<b>CINEMA</b>	A setting that boosts dark tones; best suited for movies.
<b>CUSTOM</b>	Custom setting.

# OSD (On-Screen-Display) Controls

**NOTE:** Some functions may not be available depending on the model or optional equipment.

**Input source:** HDMI1

**Main Menu Icons:** INPUT, PICTURE, AUDIO, SCHEDULE, MULTINPUT, OSD, MULTIBSP, PROTECT, CONTROL, OPTION, SYSTEM, C MODULE

**Main Menu Item:** PICTURE: PICTURE MODE

**Sub Menu:** BRIGHTNESS, GAMMA, COLOR, CONTRAST, SHARPNESS, UHD UPSCALING, ASPECT, ADVANCED, ROTATION, SPECTRAVIEW ENGINE, RESET

**Adjustment Settings:** PICTURE MODE, PRESET, SVE-1 SETTING PROGRAMMABLE1, LUMINANCE 100%, BLACK 5%, GAMMA sRGB, CUSTOM VALUE ---, WHITE 6500 K, WHITE (x, y) x: 0.279 y: 0.292, RED (x, y) x: 0.683 y: 0.306, GREEN (x, y) x: 0.191 y: 0.709, BLUE (x, y) x: 0.153 y: 0.044, COLOR VISION EMU OFF, UNIFORMITY OFF, METAMERISM ON/OFF, COLOR CONTROL, R - 0, Y - 0, G - 0, C - 0, B - 0, M - 0

**Key Guide:** **▲▼:Select** **⊕:Goto Adjustment** **⏏:Return** **⌂:Close**

\*: This menu is only available when the optional Raspberry Pi Compute Module Interface Board and Raspberry Pi Compute Module are installed.

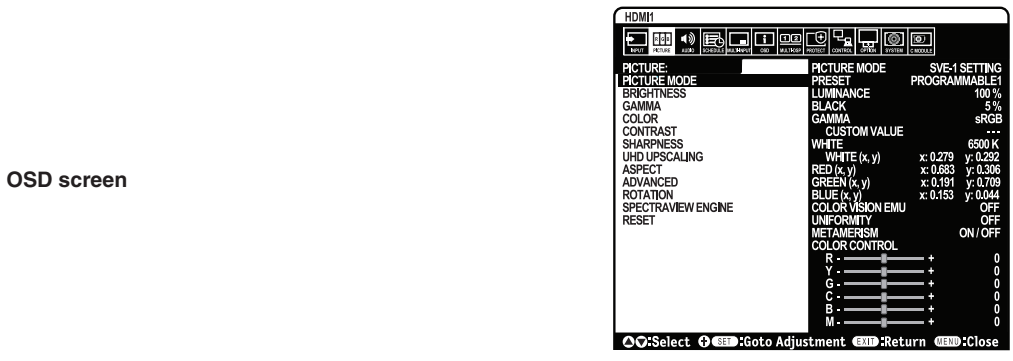
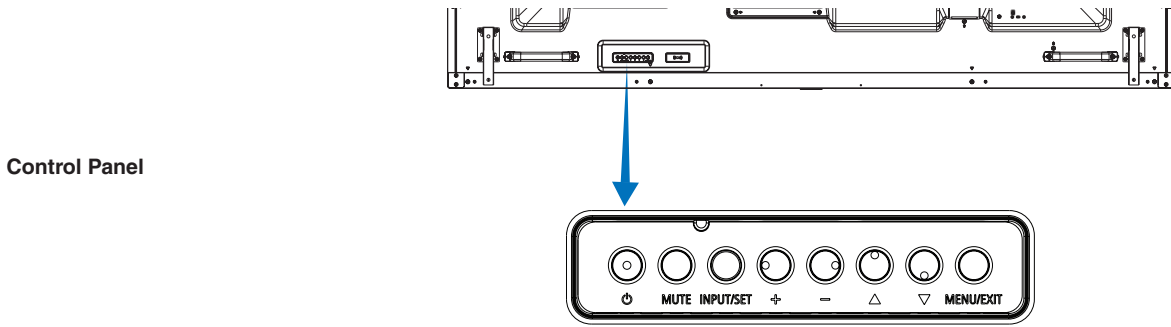
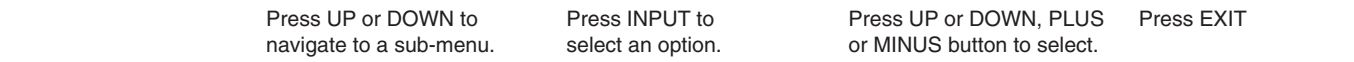
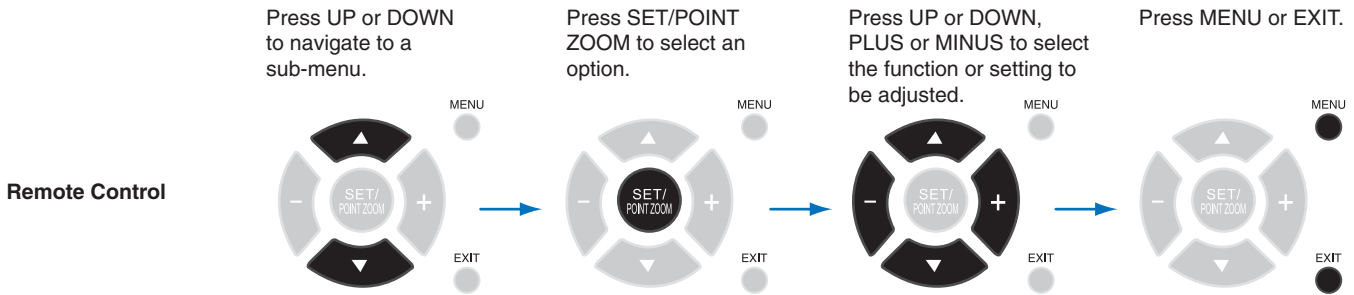

INPUT	
DisplayPort1	Select input signal.
DisplayPort2	
HDMI1	
HDMI2	
HDMI3	
MP	Displays images or movies saved in microSD memory card or USB storage device. Please refer to the Media Player setting (See <a href="#">page 22</a> ).
COMPUTE MODULE*6	Select input signal.
OPTION*3	Select input signal.
PICTURE	
PICTURE MODE	Select picture mode: SpectraView Engine = OFF: [HIGHBRIGHT], [STANDARD], [sRGB], [CINEMA], [CUSTOM1], [CUSTOM2]. SpectraView Engine = ON: [SVE-1 SETTINGS], [SVE-2 SETTINGS], [SVE-3 SETTINGS], [SVE-4 SETTINGS] or [SVE-5 SETTINGS]. See <a href="#">page 29</a> . NOTE: If WHITE is set to NATIVE when the SPECTRAVIEW is ON, WHITE is not functioning. To be able to set the CUSTOM VALUE, please set CST at GAMMA.
BRIGHTNESS*1	
BACKLIGHT	Adjusts the overall image and background brightness. Press + or - to adjust. NOTE: When MODE1 or MODE2 is selected in ROOM LIGHT SENSING, this function cannot be changed.
BRIGHTNESS*2	Adjusts the image brightness in relationship to the background. Press + or - to adjust.
GAMMA*1, *2, *5	Select a monitor gamma correction for best picture quality. Selection depends on the desired usage.
NATIVE	Gamma correction is handled by the LCD panel.
2.2	Typical monitor gamma for use with a computer.
2.4	Good for video (DVD, etc.)
S GAMMA	Special gamma for certain types of movies. Raises the dark parts and lowers the light parts of the image (S-Curve).
DICOM SIM.	DICOM GSDF curve simulated for LCD type.
HDR-ST2084 (PQ)	Gamma setting for HDR, typically for UHD disk media and streaming videos.
HDR-HYBRID LOG	Gamma setting for HDR, typically for UHD broadcasting. System gamma can be adjusted.
PROGRAMMABLE1, 2, 3	A programmable gamma curve can be loaded using optional NEC software.
AUTO HDR SELECT <small>HDMI input only</small>	GAMMA correction of HDR signal automatically changes to HDR-ST2084 (PQ) or HDR-HYBRID LOG.
COLOR*2	
COLOR	Adjusts the color depth of the screen. Press + or - to adjust.
COLOR TEMPERATURE*1	Adjusts the color temperature of the entire screen. A low color temperature will result in a reddish screen. A high color temperature will make the screen bluish. If TEMPERATURE needs further adjustment, the individual R/G/B/ levels of the white point can be adjusted. To adjust the R/G/B levels, set CUSTOM as COLOR TEMP selection. NOTE: Predefined 6500k is set as picture mode, a color temperature of 6500k is predefined so it cannot be changed. When PROGRAMMABLE1, PROGRAMMABLE2 or PROGRAMMABLE3 is selected in GAMMA CORRECTION, this function cannot be changed.
COLOR CONTROL	Adjusts the hue of the Red, Yellow, Green, Cyan, Blue and Magenta.
HUE*4 <small>MP input only</small>	Adjusts the hue of the screen. Press + or - to adjust.
CONTRAST*1, *2	Adjusts the image brightness in relationship to the input signal. Press + or - to adjust.
SHARPNESS*1	Adjusts the crispness of the image. Press + or - to adjust.
UHD UPSCALING*1	Achieves high-definition effect.

\*1: If SPECTRAVIEW ENGINE is ON, this function is grayed out.

\*2: This function is not available when sRGB is selected at PICTURE MODE.

\*3: When you select OPTION for signal input, this function depends on which Option Board you are using.

\*4: This function is not available for still image by MP input.

\*5: When you use HDR signal, SPECTRAVIEW ENGINE should be OFF.

\*6: This function is only available when Raspberry Pi Compute Module Interface Board and Raspberry Pi Compute Module are installed.



<b>ASPECT</b>		<p>Select the aspect ratio of the screen image.</p> <p>NOTE: When the ASPECT is set to DYNAMIC, the image will be changed to FULL image before IMAGE FLIP, then start IMAGE FLIP.</p> <p>When the ASPECT is DYNAMIC or ZOOM, the image will be changed to FULL image before TILE MATRIX, and then start TILE MATRIX. After TILE MATRIX, the ASPECT will be returned to the previous ASPECT or set ASPECT during TILE MATRIX.</p> <p>If SCREEN SAVER is set, the ASPECT setting automatically changes to FULL from what you set. Once SCREEN SAVER is off the ASPECT setting will go back to the setting that you originally set.</p> <p>This function is not available when MOTION in SCREEN SAVER is active.</p> <p>When the ASPECT is set to DYNAMIC or ZOOM while TILE MATRIX is set to active, after releasing TILE MATRIX, DYNAMIC or ZOOM will be active.</p> <p>POINT ZOOM function has limitations, please refer to POINT ZOOM (See <a href="#">page 59</a>).</p> <p>Zoom is also not available for an image with input resolution at 3840 x 2160 (60 Hz) and 4096 x 2160 (60 Hz).</p>
NORMAL		Shows the aspect ratio as it is sent from the source.
FULL		Fills the entire screen.
WIDE		Expands a 16:9 letterbox signal to fill the entire screen.
DYNAMIC		Expands 4:3 pictures to fill the entire screen with non-linearity image. Part of the outside image area will be cut off due to expansion.
1:1		Shows the image in a 1 by 1 Pixel format. (If the input resolution is higher than the recommended resolution, the image will be scaled down to fit the screen.)
ZOOM		Expands/reduces the image. NOTE: The areas of the expanded image that are outside of the active screen area are not shown. The reduced image may have some image degradation.
ZOOM		Maintains the aspect ratio while zooming.
HZOOM		Horizontal zoom value.
VZOOM		Vertical zoom value.
H POS		Horizontal position.
V POS		Vertical position.
<b>ADVANCED</b>		
<b>OVER SCAN</b> <small>HDMI1, HDMI2, HDMI3, MP, OPTION*1  inputs only</small>		Some video formats may require different scanning modes in order to best display the image.
ON		Image size is larger than what can be displayed. Some images will have cropped edges. Approximately 95% of the image will be shown on the screen.
OFF		Image size stays within the display area. The whole image is displayed on the screen. This setting may cause distorted image at the edges. NOTE: When you use a computer with HDMI out, please set "OFF".
AUTO		Image size is set automatically. NOTE: This function is not available if input signal is MP.
<b>DEINTERLACE</b>		Selects the IP (Interlace to Progressive) conversion function. NOTE: IMAGE FLIP is not available. When SUPER is selected in INPUT CHANGE and displayed, this function cannot be changed.
ON		Converts interlaced signals to progressive. This is the default setting.
OFF		Disables IP conversion. This setting is best suited for motion pictures but increases the risk of image retention.
<b>TELECINE</b> <small>HDMI1, HDMI2, HDMI3, MP inputs only</small>		Automatically senses the sources frame rate for optimal picture quality. NOTE: Set DEINTERLACE to ON if TELECINE is AUTO.
<b>ADAPTIVE CONTRAST*2</b> <small>HDMI1, HDMI2, HDMI3, MP inputs only</small>		Sets the level of adjustment for dynamic contrast. If HIGH is set, the image is displayed clearly but it makes brightness unstable due to the wide gap of contrast variation.

\*1: This function depends on which Option Board you are using.

\*2: If SPECTRAVIEW ENGINE is ON, this function is grayed out.























ROTATION	Shows the inverse image right-left, up-down or rotation. Press + or - to select. NOTE: This function is not available when MOTION in SCREEN SAVER is "ON".
IMAGE FLIP	NOTE: When the ASPECT is set to DYNAMIC, the image will be changed to FULL image before ROTATE starts. When selecting IMAGE FLIP (except for NONE), the following functions are disabled: MULTI PICTURE MODE, TEXT TICKER, STILL, POINT ZOOM and TILE MATRIX. When the input signal is interlaced, the image may be distorted.
NONE	Normal mode. <b>AB</b>
H FLIP	The image inverts right-left. <b>BA</b>
V FLIP	The image inverts up-down. <b>VB</b>
180° ROTATE	The image rotates 180 degrees. <b>BA</b>
OSD FLIP	Determines the OSD display direction. If "ON" is selected, the OSD will be inverted depending on the image status.
SPECTRAVIEW ENGINE	Select "ON" to activate SPECTRAVIEW ENGINE (see <a href="#">page 29</a> ).
RESET	Resets all "PICTURE" settings back to factory settings except for SPECTRAVIEW ENGINE and PICTURE MODE.
<b>AUDIO</b>	
VOLUME	Increase or decrease output volume level.
BALANCE	
BALANCE	Select STEREO or MONO for the audio output. If you select STEREO, adjust the L/R volume balance. Press the + button to move the stereo sound image to right. Press the - button to move the stereo sound image to left. NOTE: BALANCE is not available if MONO is set at STEREO/MONO.
SURROUND	Artificial surround sound. NOTE: LINE OUT is disabled when this function is set to "ON".
EQUALIZER	
TREBLE	Accentuate or reduce the high frequency range of audio signals. Press the + button to increase TREBLE. Press the - button to decrease TREBLE.
BASS	Accentuate or reduce the low frequency sound. Press the + button to increase BASS. Press the - button to decrease BASS.
AUDIO INPUT	Selects the audio input source: [HDMI1], [HDMI2], [HDMI3], [DisplayPort1], [DisplayPort2], [IN], [MP], [OPTION]*1.
MULTI PICTURE AUDIO	Selects which audio source to use when MULTI PICTURE is enabled. When either picture number is selected, the sound of that picture is output
LINE OUT	Selecting VARIABLE enables control of the line out level with the VOLUME button.
AUDIO DELAY	
AUDIO DELAY	Activate a delay time to output the audio signal. The DELAY TIME can be set between 0 and 100 milliseconds.
DELAY TIME	Set to ON to activate this function.
RESET	Resets all AUDIO options back to factory settings, except for VOLUME.

\*1: This function depends on which Option Board you are using.

## SCHEDULE

SCHEDULE SETTINGS	<p>Creates a working schedule for the monitor.            Press the ▲ ▼, +, - buttons to navigate and change the schedule settings. Press the SET/ZOOM on the remote or Input change buttons on the monitor to select settings.            NOTE: Please set DAY &amp; TIME before configuring the SCHEDULE SETTINGS.            When the SCHEDULE SETTINGS window is closed, any schedules that you set are saved.            If schedules are set for the same time, higher SETTINGS numbers are given the priority.            If OFF TIMER is ON, SCHEDULE SETTINGS is not available.            When you select an invalid input signal or picture mode, it will display in red. While the SCHEDULE SETTINGS window is open, schedules are not operated. Also, see <a href="#">page 46</a>.</p>
SETTINGS	Set ON to activate the schedule. Maximum 30 schedules are set.
POWER	Setting for the monitor power. Please set ON or OFF for each schedule.
TIME	Set the schedule operation time. If there is no specific time for the schedule set [--].
INPUT	Set the input signal for the schedule. To keep the input signal that is active when the schedule starts set [--]. When you set INPUT, please select ON at POWER.
PIC. MODE	Set the picture mode for the schedule. To keep the picture mode that is active when the schedule starts set [--]. When you set PIC. MODE, please select ON at POWER.
	Select one item from below (only one item is available).
DATE	Select this setting if the schedule is for one day schedule or irregular schedules.
EVERY DAY	Select this setting if the schedule is repeating every day.
EVERY WEEK	Select this setting if the schedule is repeating every week.
WEEKDAY	Select this setting if the schedule is on a weekday. This item is set by the WEEKEND and the HOLIDAY settings. A day, which is not selected at WEEKEND and HOLIDAY settings is set as a weekday.
WEEKEND	Select this setting if the schedule is on a weekend. Schedule operates on the date that is set at WEEKEND SETTINGS.
HOLIDAY	Schedule operates on the date that is set at HOLIDAY SETTINGS.
SCHEDULE LIST	List of working schedules. Displays up to 30 schedules.
HOLIDAY SETTINGS	
No.	Creates holiday schedule for the monitor.
YEAR MONTH DAY WEEK	Set YEAR and MONTH. Select DAY or WEEK. DAY: Set a day. WEEK: Set a week and the day of the week. If you set [--] at MONTH or YEAR, every month or year of the day you select is set as a holiday.
END DAY	Set the end of holiday date. If you schedule beyond a year, please separate the schedule per year. NOTE: If DAY is not set, END DAY is not available. If your holiday setting includes [--] for year or month, END DAY is not available.
SET/DELETE	Sets or deletes a schedule.
WEEKEND SETTING	
WEEKEND	Set the day of the week.
DATE & TIME	<p>Sets the date, time, and daylight savings region. Date &amp; time must be set in order for the "SCHEDULE" function to operate.            NOTE: If the monitor's main power has been turned off for two weeks, the DATE &amp; TIME setting goes back to the default setting and the clock function stops working.</p>
YEAR	Sets the year for the real-time clock.
MONTH	Sets the month for the real-time clock.
DAY	Sets the day for the real-time clock.
TIME	Sets the time for the real-time clock.
CURRENT DATE TIME	Shows the current date and time.

DAYLIGHT SAVING	Sets daylight savings on or off. NOTE: Please set the TIME & DATE setting first if you change the DAYLIGHT SAVING setting.														
DAYLIGHT SAVING	If ON is selected, please set daylight savings settings below.														
BEGIN MONTH	Set daylight savings beginning date.														
END MONTH	Set daylight savings ending date.														
TIME DIFFERENCE	Set the time difference.														
OFF TIMER	Set the monitor to power off after a preset time period. A time period between 1 to 24 hours may be set. NOTE: SCHEDULE is not available if OFF TIMER is ON.														
RESET	Resets the following settings within the SCHEDULE menu back to factory setting: DATE & TIME and DAYLIGHT SAVING.														
<b>MULTI INPUT</b>															
KEEP MULTI PICTURE MODE*1	Allows the monitor to remain in MULTI PICTURE and TEXT TICKER mode after powering off. When Power is returned, MULTI PICTURE and TEXT TICKER appear without having to enter the OSD.														
MULTI PICTURE MODE*1,*3	Selects picture number and display form.														
MULTI PICTURE	When "OFF" is selected, one picture is displayed. When "ON" is selected, several pictures are displayed. Select PIP or PBP. NOTE: When "ON" is selected, TEXT TICKER, TILE MATRIX, MOTION in SCREEN SAVER, IMAGE FLIP except for NONE, SUPER in INPUT CHANGE is released.														
PICTURE NUMBER	Selects [2 PICTURES], [3 PICTURES], [4 PICTURES]. After selected PICTURE NUMBER, select display form PIP, PBP1, PBP2, or PBP3. Depending on the setting at PICTURE NUMBER, display form selection is changed. PICTURE NUMBER: 2 PICTURES <table border="1"> <tr> <td>PIP</td> <td>PBP1</td> </tr> <tr> <td></td> <td></td> </tr> </table> PICTURE NUMBER: 3 PICTURES <table border="1"> <tr> <td>PIP</td> <td>PBP1</td> <td>PBP2</td> <td>PBP3</td> </tr> <tr> <td></td> <td></td> <td></td> <td></td> </tr> </table> PICTURE NUMBER: 4 PICTURES <table border="1"> <tr> <td></td> <td>A: PICTURE 1 B: PICTURE 2 C: PICTURE 3 D: PICTURE 4</td> </tr> </table>	PIP	PBP1			PIP	PBP1	PBP2	PBP3						A: PICTURE 1 B: PICTURE 2 C: PICTURE 3 D: PICTURE 4
PIP	PBP1														
															
PIP	PBP1	PBP2	PBP3												
															
	A: PICTURE 1 B: PICTURE 2 C: PICTURE 3 D: PICTURE 4														
ACTIVE PICTURE*1,*2															
ACTIVE	When MULTI PICTURE is "OFF", [PICTURE 1] is the Active Picture. When MULTI PICTURE is "ON", sets Active Picture. NOTE: This function depends on MULTI PICTURE setting.														
ACTIVE FRAME	The active picture is shown within a red frame.														
INPUT SELECT*1,*2,*3	Selects the Multi Picture input. Press the + button or - button to select the input. NOTE: This function is not available when MULTI PICTURE is "OFF". When changing input signal for the active picture, after selecting an input press SET.														
PICTURE SIZE*1,*2,*4	Sets the Active Picture size. Press the SET/POINT ZOOM button to adjust the picture size. Press + or CH+ to expand. Press - or CH- to reduce. NOTE: This function is not available when MULTI PICTURE is set to 4 PICTURES PBP. Depends on the setting at MULTI PICTURE MODE, some pictures cannot change their size.														
PICTURE POSITION*1,*2,*4	Sets the Active Picture location. Pressing the + button moves the Active Picture to the right, and pressing the - button moves it to the left. Pressing the ▲ button moves the Active Picture up, and pressing the ▼ button moves it down.														
ROTATE	When "ON" is selected, all pictures rotate. When "OFF" is selected, sets each picture ROTATE settings. NOTE: When TEXT TICKER, IMAGE FLIP except for NONE, STILL is ON or SCREEN SAVER is active, this function is not available. If "1:1" is selected in ASPECT, characters and lines may be displayed in blurring, depending on the signal resolution. When ROTATE is ON, POINT ZOOM and IMAGE FLIP except for NONE are not available. Each picture ROTATE settings are released when MULTI PICTURE is set to "OFF". When input signal is Interlace, the image may be distorted. When HDMI of the TERMINAL SETTINGS is set to MODE2, or [3 PICTURES] or [4 PICTURES] is selected at PICTURE NUMBER in MULTI PICTURE MODE, ROTATE is not available. If ROTATE of MULTI PICTURE CONTROL is selected in the input signal with a high refresh rate, the image may not be displayed smoothly. To reduce this condition please set the input signal with a low refresh rate.														
PICTURE ASPECT*1,*2,*4	Selects the Active Picture frame aspect. To change aspect ratio of the screen image see <a href="#">page 21</a> .														

\*1: This function is released when selecting SUPER in INPUT CHANGE, MOTION in SCREEN SAVER, TILE MATRIX and IMAGE FLIP except for NONE.

\*2: When TEXT TICKER is active or MULTI PICTURE is OFF, this function is not available.

\*3: When you select OPTION for multi picture input, this function depends on which Option Board you are using.

\*4: This function is not available if PIP is set at MULTI PICTURE MODE and then PICTURE1 is set at ACTIVE PICTURE.

TEXT TICKER*1, *2	NOTE: When TEXT TICKER is set, MULTI PICTURE MODE and STILL are not available. TEXT TICKER is released if following menu is activated: MULTI PICTURE MODE, TILE MATRIX, SCREEN SAVER, IMAGE FLIP, SUPER in INPUT CHANGE. When this function is active, POINT ZOOM and STILL are not available.
MODE	Enables Text Ticker and allows you to set Horizontal or Vertical direction.
POSITION	Selects the location of the Text Ticker on the screen.
SIZE	Determines the size of the Text Ticker in relationship to the overall screen size.
DETECT	Enables auto-detection of the Text Ticker.
INPUT SELECT	Set input signal for PICTURE1, PICTURE2.
INPUT DETECT*4	Selects the method of input detection the monitor uses when more than one signal source is connected. NOTE: When SUPER is selected within INPUT CHANGE, this function cannot be changed. INPUT DETECT is released if HUMAN SENSOR is activated while INPUT DETECT is active.
NONE	The Monitor will not search for signals at the other video input ports.
FIRST DETECT*2, *3	When the current video input signal is not present, the monitor searches for a video signal from another video input port. If a video signal is present in the other input, the monitor switches from the current video source to this active video source automatically. The monitor will not look for any other video signals while the current video source is present.
LAST DETECT*2, *3	When the monitor is reproducing a signal from the current video source and a new second video source is supplied to the monitor, the monitor will automatically switch to the new video source. When the current video input signal is not present anymore, the monitor searches for a video signal from any other video input. If a video signal is present in the other input, the monitor switches from the current video source to this active video source automatically.
CUSTOM DETECT*2	Sets the priority of input signals. When CUSTOM DETECT is selected, the monitor searches on preset inputs only. NOTE: Priority of an option input signal is only available in PRIORITY3, except for a slot 2 type PC option. If you set DisplayPort1 to Priority 1 or 2 or 3, you cannot set OPTION (slot 2 type PC option (DP)) to any priority settings. If you set OPTION (slot 2 type PC option (DP)) to Priority 1 or 2 or 3, you cannot set DisplayPort1 to any priority settings.
INPUT CHANGE	Sets input change speed. If "QUICK" is set, speed of changing input is faster but this setting may cause image distorted while switching signals. Selecting SUPER enables high-speed switching between two preset signals. NOTE: Depending on the Option Board you use, SUPER may not be available. When "SUPER" is active, MULTI PICTURE MODE, TEXT TICKER, STILL, POINT ZOOM are not available.
TERMINAL SETTINGS	
DisplayPort	Selects the DisplayPort mode [1.1a] or [1.2]. DisplayPort 1.1a is selected, SST is set automatically. DisplayPort 1.2 is selected, set SST or MST. DisplayPort 1.2 should be selected when using Multi-Stream Transport. Multi-Stream Transport requires a corresponding display card. Contact your supplier for limitations of this function. NOTE: MST is not available with DisplayPort IN2 signal input.
BIT RATE	DisplayPort 1.1a is selected at DisplayPort, HBR is set automatically. DisplayPort1.2 and SST are selected at DisplayPort, set HBR or HBR2. DisplayPort1.2 and MST are selected at DisplayPort, HBR2 is set automatically.
HDMI	Selects MODE1 or MODE2. MODE1: Max resolution is 4096 x 2160 (30 Hz) MODE2: Max resolution is 4096 x 2160 (60 Hz)
VIDEO LEVEL	RAW: For computer settings. Show all input signals of 0-255 gray levels. EXPAND: For audio-visual equipment settings. Expands the input signals from 16-235 gray levels to 0-255 gray levels. AUTO: Automatically sets input signals by adjusting connected equipment. NOTE: This function is available only in HDMI or DisplayPort or OPTION and is selected at INPUT SIGNAL.
SIGNAL FORMAT	Selects the color space setting for the HDMI/DisplayPort signal. If SLOT2 CH SETTING is 2CH, this function is grayed out.
RESET	Resets MULTI INPUT options back to factory settings, except for INPUT DETECT (priority of input signals only), INPUT CHANGE (INPUT1 and INPUT2), INPUT SELECT, PICTURE ASPECT and BIT RATE.

\*1: This function is released when selecting SUPER in INPUT CHANGE, MOTION in SCREEN SAVER, TILE MATRIX and IMAGE FLIP except for NONE.

\*2: When you select OPTION for multi picture input, this function depends on which Option Board you are using.

\*3: Except for MP.

\*4: Depending on the device, it may not be detected correctly.

OSD	
LANGUAGE	Select the language used by the OSD.
ENGLISH	
DEUTSCH	
FRANÇAIS	
ITALIANO	
ESPAÑOL	
SVENSKA	
РУССКИЙ	
中文	
日本語	
OSD TIME	Turns off the OSD after a period of inactivity. The preset choices are 10-240 seconds.
OSD POSITION	Determines the location where the OSD appears on the screen.
UP	
DOWN	
RIGHT	
LEFT	
INFORMATION OSD	Selects whether the Information OSD is displayed or not. The Information OSD will appear when the input signal or input source changes. The Information OSD will also give a warning when no signal is detected or the signal is out of range. An interval between 3 to 10 seconds is selectable for the Information OSD to appear.
COMMUNICATION INFO.	The MONITOR ID and IP ADDRESS will appear when the remote control Display button is pressed.
OSD TRANSPARENCY	Selects the transparency of the OSD.
OSD ROTATION	Determines the OSD orientation between landscape and portrait.
LANDSCAPE	Shows the OSD in landscape orientation.
PORTRAIT	Shows the OSD in portrait orientation.
KEY GUIDE	Key guide is shown when the OSD menu is displayed. NOTE: This function is not available when OSD FLIP is "ON".
MEMO	Displays the MEMO title and message set via the HTTP server. See <a href="#">page 56</a> .
INPUT NAME	You can create a name for the INPUT currently being used. Max: 14 characters, including Space, A-Z, 0-9, and some symbols.
RESET	Resets the following settings within the OSD menu back to factory setting: OSD TIME, OSD POSITION, INFORMATION OSD, OSD TRANSPARENCY.
MULTI DISPLAY	
AUTO TILE MATRIX SETUP	TILE MATRIX allows one image to be displayed over multiple screens (up to 100) through a distribution amplifier. Allows auto setting of TILE MATRIX by inputting the number of monitors arranged horizontally and vertically on the primary monitor. Following settings are set automatically: MONITOR ID, TILE MATRIX, TILE MATRIX MEM, Input Signal, VIDEO OUT SETTING, DisplayPort in TERMINAL SETTINGS. NOTE: AUTO ID will be automatically executed. When you use this function, it is recommended that monitors be chained by DisplayPort cable. This function is released if MOTION in SCREEN SAVER is activated. Example of installation via LAN: H MONITORS 3 V MONITORS 3
SETTING COPY	In a daisy chain scenario, select the OSD menu categories that you want to copy over to the other monitors. NOTE: When you use this function, monitors should be daisy chained by LAN cables. The selection of which settings to copy will be reset to default when powered off. This function has a limit in the number of connected monitors, depending on type and quality of the LAN cable being used.
COPY START	Select "YES" and press the SET button to start copying.
ALL INPUT	All input terminals settings are copied when you select this item. Default is off.

TILE MATRIX	<p>Allows one image to be expanded and displayed over multiple screens (up to 100) through a distribution amplifier.</p> <p>NOTE: Low resolution is not suitable for tiling to a large number of monitors. You can operate without a distribution amplifier at a lower number of screens.</p> <p>This function is released when selecting SCREEN SAVER or IMAGE FLIP except for NONE.</p> <p>"DYNAMIC" and "ZOOM" will not work when Tile Matrix is activated.</p> <p>When "DYNAMIC" or "ZOOM" is selected in ASPECT while executing TILE MATRIX, the setting will be applied after completing the TILE MATRIX.</p> <p>When TILE MATRIX is active the following functions are not available: MULTI PICTURE MODE, TEXT TICKER, STILL, POINT ZOOM. Please refer to the POINT ZOOM function for more detail (see <a href="#">page 59</a>).</p> <p>If Media Player contents are played while TILE MATRIX is active, the image play timing might have a gap within monitors.</p> <p>This function is not available when SCREEN SAVER is active.</p> <p>When HDMI of the TERMINAL SETTINGS is set to MODE2, TILE MATRIX is not available.</p>
H MONITORS	Number of monitors arranged horizontally.
V MONITORS	Number of monitors arranged vertically.
POSITION	Select which section of the tiled image to be displayed on the monitor.
TILE COMP	Turns the TILE COMP feature on. If YES is set to the TILE COMP, you can adjust a displayed image size and position by pressing the + button or the - button on the remote control.
ENABLE	Enables the TILE MATRIX settings.
TILE MATRIX MEM	When "INPUT" is selected, the TILE MATRIX setting is applied to each signal input.
COMMON	All settings in the TILE MATRIX are saved for all signal inputs.
INPUT	All settings in the TILE MATRIX are saved for the selected signal input.
ID CONTROL	<p>Sets the monitor ID number from 1-100 and group ID from A-J. DETECTED MONITORS shows the number of all monitors that are included in the daisy chain of connected LAN cables.</p> <p>NOTE: Do not turn off the monitors' main power switch or put it into standby while AUTO ID/IP SETTING or AUTO ID/IP RESET is activating.</p> <p>The Group ID is made of multiple selections.</p>
AUTO ID/IP SETTING	<p>When "SET" is selected, AUTO ID/IP SETTING window is shown.</p> <p>Do not connect network devices between the monitors connected with LAN.</p>
SETTING ITEM	Select an item from [MONITOR ID], [IP ADDRESS] and [ID and IP].
MONITOR ID	When "YES" is selected the monitor ID numbers are set automatically for all monitors.
IP ADDRESS	<p>Set the first octet to the third octet at "BASE ADDRESS".</p> <p>The fourth octet is automatically set from "1" and counting up to the number of monitors connected with LAN.</p> <p>"BASE ADDRESS" is shown when "IP ADDRESS" or "ID and IP" is selected at SETTING ITEM.</p>
ID and IP	Set "MONITOR ID" and "IP ADDRESS".
BASE NUMBER	<p>Set base number within 100 for the master monitor.</p> <p>The other monitors that follow in the LAN chain will be given an individual monitor ID automatically. The monitor ID given to each monitor counts up based on the base number of the master monitor. The monitor ID range is 1 to 100. Please choose a starting number that is low enough to include all connected monitors.</p>
BASE ADDRESS	When "YES" is set, the monitor IP ADDRESS is set automatically for all monitors.
ID/IP SETTING START	When "YES" is set, all settings in the AUTO ID/IP SETTING are activated.
DETECTED MONITORS	<p>This item is shown after "SETTING ITEM" is selected and "ID/IP ADDRESS START" is set to "YES".</p> <p>If the detected number of monitors and the actual number of MONITOR IDs assigned are different, select "RETRY" to recount the monitors.</p> <p>If the shown number is correct, set "CONTINUE".</p>
AUTO ID/IP RESET	When "RESET" is selected, AUTO ID/IP RESET window is shown.
RESET ITEM	<p>Select a setting from [MONITOR ID], [IP ADDRESS], and [ID and IP].</p> <p>When the number of monitors connected with LAN is changed, please select the same item that you selected at "SETTING ITEM" in the AUTO ID/IP SETTING and then run the "AUTO ID/IP RESET".</p>
ID/IP RESET START	<p>When "YES" is set, the setting of selected item at RESET ITEM returns to default setting.</p> <p>When the setting returns to default setting, "FINISH!!" is displayed.</p> <p>NOTE: After "ID/IP RESET START" is activated, the individual settings for "MONITOR ID" and "IP ADDRESS" will be reset even though the monitor's are connected with LAN.</p>
DETECTED MONITORS	Displays the number of detected monitors.
COMMAND TRANSFER	When "ON" is set, a command is sent to all monitors connected with LAN cables.
RESET	Resets all settings within the MULTI DISPLAY menu back to the factory setting.



DISPLAY PROTECTION	
POWER SAVE	Set ENABLE or DISABLE. If you set it to ENABLE, set how long the monitor waits to go into power save mode after signal is lost. For more details please check the POWER INDICATOR (See <a href="#">page 43</a> ). NOTE: The display card might not stop sending the digital data even though the image might have disappeared. If this occurs the monitor will not switch into power management mode. POWER SAVE is disabled when AUTO OFF or CUSTOM is selected in HUMAN SENSING*3.
AUTO POWER SAVE TIME SETTING	Set the time when the monitor goes into auto power save mode after signal is lost.
POWER SAVE MESSAGE	When the monitor goes into power save mode, a message is displayed when ON is selected.
FAN CONTROL	Cooling fans will reduce the internal temperature of the monitor to protect it from overheating. If AUTO is selected, you can adjust the start temperature of the cooling fans and the fan speed.
HEAT STATUS	Shows the actual status of the fans, backlight and temperature sensors.
SCREEN SAVER	Use the SCREEN SAVER function to reduce the risk of Image Persistence. NOTE: When the screen saver is activated, the image will be changed to FULL image. After the screen saver stops, the image will be reproduced again with the current ASPECT setting. The SCREEN SAVER cannot be selected for 3840 x 2160 (60 Hz) nor 4096 x 2160 (60 Hz) signal input. When the SCREEN SAVER is set to active, MULTI PICTURE MODE, STILL, IMAGE FLIP (except for NONE) or TEXT TICKER, POINT ZOOM, TILE MATRIX are not available.
GAMMA*1	The monitor gamma is changed and fixed when "ON" is selected.
BACKLIGHT*1	The brightness of the backlight is decreased when "ON" is selected. NOTE: Do not select this function when ROOM LIGHT SENSING is set to MODE1 or MODE2.
MOTION*2	The screen image is slightly expanded and moves in 4 directions (UP, DOWN, RIGHT, LEFT) at user determined intervals. You can set interval time and zoom ratio.
SIDE BORDER COLOR	Adjusts the color of the side borders when a 4:3 image is reproduced. By pressing the + button on the remote control, the side borders will become brighter. By pressing the - button, the side borders will become darker. Background color of the Media Player window is also changed.
POWER ON DELAY	Adjusts the delay time between being in "standby" mode and entering "power on" mode.
DELAY TIME	"POWER ON DELAY" can be set between 0 and 50 seconds.
LINK TO ID	When "ON" is selected, the delay time is linked with the Monitor ID. It takes more time when there are a large number of IDs.
ALERT MAIL	Set ON to activate alert mail (See <a href="#">page 54</a> ).
INTELLI. WIRELESS DATA	Select "ON" to activate INTELLIGENT WIRELESS DATA function (see <a href="#">page 61</a> ). A password is required when using the function.
RESET	Resets all settings within the DISPLAY PROTECTION menu back to factory setting except for POWER ON DELAY and INTELLI. WIRELESS DATA.
CONTROL	
NETWORK INFORMATION	Shows the current network settings.
LAN	NOTE: When changing any LAN settings, you need to wait several seconds until modified LAN settings are applied.
IP SETTING	Enabling this option automatically assigns an IP address to the monitor from your DHCP server. Disabling this option allows you to enter a fixed IP address and subnet mask data obtained from your network administrator. NOTE: Consult your network administrator for the IP address when AUTO is selected for [IP SETTING].
IP ADDRESS	Set your IP address for the monitor connected to the network when MANUAL is selected for [IP SETTING].
SUBNET MASK	Set your subnet mask data for the monitor connected to the network when MANUAL is selected for [IP SETTING].
DEFAULT GATEWAY	Set your default gateway for the monitor connected to the network when MANUAL is selected for [IP SETTING]. NOTE: Enter [0.0.0.0] to delete the setting.
DNS	Set the IP addresses of DNS servers. AUTO: The DNS server, which is connected with the monitor, will automatically assign its IP address. MANUAL: Manually enter the IP address of the DNS server which is connected with the monitor.
DNS PRIMARY	Enter the primary DNS server settings of the network connected with the monitor. NOTE: Enter [0.0.0.0] to delete the setting.
DNS SECONDARY	Enter the secondary DNS server settings of the network connected with the monitor. NOTE: Enter [0.0.0.0] to delete the setting.

\*1: If SPECTRAVIEW ENGINE is ON, this function is grayed out.

\*2: When you select OPTION for signal input, this function depends on which Option Board you are using.

\*3: The function is available only when connecting the optional control unit.

CHANGE PASSWORD	Allows the security password to be changed. The factory preset password is 0000.
SECURITY	
PASSWORD	Input security password.
SECURE MODE	
OFF	The security password is not required when the monitor power is on.
START-UP LOCK	The security password is required when the monitor power is on.
CONTROL LOCK	The security password is required when a remote control button or a control button on the monitor is pressed.
BOTH LOCK	The security password is required when either the monitor is powered on, or a remote control button or a control button on the monitor is pressed.
IR LOCK SETTINGS	Prevents the monitor from being controlled by the wireless remote control. When ACTIVATE is selected, all settings are activated. NOTE: IR LOCK SETTINGS is a function intended only for the wireless remote control buttons. This function does not lock out access to the buttons on the monitor. To return to normal operation, press the "DISPLAY" button on the remote control and hold it down for more than 5 seconds.
MODE SELECT	Selects the mode UNLOCK, ALL LOCK or CUSTOM LOCK.
UNLOCK	All buttons on the remote control are available for normal operation.
ALL LOCK	Locks all remote control buttons.
CUSTOM LOCK	Selects which buttons to be locked from POWER, VOLUME, and INPUT button. Except for CUSTOM LOCK settings, other buttons on the remote control are locked. POWER: When LOCK is selected, the POWER button is locked. VOLUME: When UNLOCK is selected, set the minimum and maximum volume between VOL.0 to VOL.100. VOLUME (+) button and VOLUME (-) buttons are only available from the minimum volume to the maximum volume you set. When LOCK is selected, VOLUME (+) button and VOLUME (-) buttons are locked. INPUT: When UNLOCK is selected, choose up to three buttons from DisplayPort1, DisplayPort2, HDMI1, HDMI2, HDMI3, MEDIA PLAYER, OPTION which you prefer to be unlocked. The unselected buttons are locked. When LOCK is selected, all INPUT buttons are locked. CHANNEL: To lock channel buttons on the remote control, select it to LOCK then press ACTIVE, channel CH/ZOOM (+) button and (-) button are locked.
KEY LOCK SETTINGS	Prevents the monitor from being controlled by the buttons on the monitor. When ACTIVATE is selected all of the settings are activated. NOTE: KEY LOCK SETTINGS is a function intended only for the buttons of the monitor. This function does not lock out access to all buttons on the remote control. To activate the control key lock function, press the UP button (▲) and the DOWN button (▼) and hold down simultaneously for more than 3 seconds. To resume user mode, press the UP button (▲) and the DOWN button (▼) and hold simultaneously for more than 3 seconds.
MODE SELECT	Selects the mode UNLOCK, ALL LOCK or CUSTOM LOCK.
UNLOCK	All buttons are available for normal operations.
ALL LOCK	Locks all remote control buttons.
CUSTOM LOCK	Selects which buttons to be locked from POWER, VOLUME, and INPUT button. Except for CUSTOM LOCK settings, other buttons on the remote control are locked. POWER: When LOCK is selected, the POWER button is locked. VOLUME: When UNLOCK is selected, set the minimum and maximum volume between VOL.0 to VOL.100. The PLUS button (+) and the MINUS button (-) are only available from the minimum volume to the maximum volume you set. When LOCK is selected, the PLUS button (+) and the MINUS button (-) are locked. INPUT: When UNLOCK is selected, the INPUT/SET button is unlocked. CHANNEL: To lock channel buttons on the remote control, select it to LOCK then press ACTIVE, the UP button (▲) and the DOWN button (▼) are locked.
DDC/CI DisplayPort2 input only	ENABLE/DISABLE: Turns ON or OFF the two-way communication and control of the monitor.
PING	Confirm successful connection with the network by communicating with a preset IP address.
IP ADDRESS	Sets an IP ADDRESS for sending PING.
EXECUTE	Checks a reply can be sent to the monitor or not from the IP ADDRESS by sending PING.
IP ADDRESS RESET	Resets IP ADDRESS SETTINGS back to factory settings.



AUTO DIMMING*1	Adjusts the backlight of the LCD automatically depending on the amount of ambient light.
AUTO BRIGHTNESS DisplayPort1, DisplayPort2, MP, OPTION*3 inputs only	Adjusts the brightness level according to the input signal. NOTE: Do not select this function when ROOM LIGHT SENSING is MODE1 or MODE2.
ROOM LIGHT SENSING	<p>The backlight of the LCD screen can be set to increase or decrease depending on the amount of ambient light within the room. If the room is bright, the monitor becomes correspondingly bright. If the room is dim, then the monitor will dim accordingly. The purpose of this function is to make the viewing experience more comfortable to the eye in a variety of lighting conditions.</p> <p>NOTE: When ROOM LIGHT SENSING is set, BACKLIGHT, AUTO BRIGHTNESS and BACKLIGHT in SCREEN SAVER functions are disabled.</p> <p>Do not cover the room light sensing sensor when you use MODE1 or MODE2.</p> <p>AMBIENT parameter setting ROOM LIGHT SENSING in OSD, select MODE1 or MODE2 and set MAX LIMIT, IN BRIGHT and IN DARK in each mode.</p> <p>MAX LIMIT: This is the max level of backlight, which you set. IN BRIGHT: This is the backlight level that the monitor will go up to when the ambient light level is highest. IN DARK: This is the level of backlight that the monitor will go down to when the ambient light level is low.</p> <p>When the ROOM LIGHT SENSING is enabled the Backlight level of the screen changes automatically according to the lighting conditions of the room (see figure below).</p> <p>MAX LIMIT: BACKLIGHT level is limited to your set level. IN DARK: BACKLIGHT level set for the monitor to use when ambient lighting level is low. IN BRIGHT: BACKLIGHT level set for the monitor to use when ambient lighting level is high.</p>
BACKLIGHT DIMMING*1	Automatically adjusts each of the clusters of the backlight of the LCD independently, according to the input signal.
HUMAN SENSING*2	HUMAN SENSING has three settings. NOTE: POWER SAVE is disabled when AUTO OFF or CUSTOM is selected in HUMAN SENSING. HUMAN SENSING is released if INPUT DETECT is set while HUMAN SENSING is active.
DISABLE	No human sensing.
AUTO OFF	At the preset time, when no person is detected, BACKLIGHT and VOLUME automatically go into OFF. When a person comes near the monitor again, the monitor will automatically return to normal mode.
CUSTOM	BACKLIGHT and VOLUME automatically shift to the set value when detecting no person. When a person comes near the monitor again, the monitor automatically returns to normal mode and reproduces the input signal selected in INPUT SELECT.
POWER INDICATOR	
POWER INDICATOR	Turns the LED on or off. If OFF is selected, the LED will not glow when the LCD monitor is in active mode.
SCHEDULE INDICATOR	Turns the LED on or off depending on a schedule activity which is set at "SCHEDULE SETTINGS". If OFF is selected, the LED will not glow even if a schedule is in active mode.
NETWORK FUNCTIONS	<p>Individually enable or disable the networking component for these monitor functions:</p> <p>DISPLAY: Enables or disables the network function for controlling the monitor remotely. When disabled, these functions do not work: External Control, MAIL, Daisy chain functions, HTTP server, SNMP, CRESTRON, AMX, PJLink.</p> <p>NOTE: If you disable DISPLAY, monitor control in a daisy chain configuration is not available. Please be aware of the impact in multi-monitor installations before disabling it.</p> <p>COMPUTE MODULE: Enables or disables the network function for the Compute Module Interface Board only.</p> <p>MEDIA PLAYER: Enables or disables the network function for the Media Player only. When disabled, these functions do not work: SHARED FOLDER SETTINGS and SHARED SD CARD SETTINGS.</p> <p>Under APPLY, Highlight YES then press SET to save your selection. If you do not press SET when YES is highlighted, your selections are not saved.</p> <p>NOTE: To apply a firmware version update over the network, DISPLAY and MEDIA PLAYER must be enabled.</p>

\*1: If SPECTRAVIEW ENGINE is ON, this function is grayed out.

\*2: The function is available only when connecting the optional sensor unit.

\*3: When you select OPTION for signal input, this function depends on which Option Board you are using.

<b>USB</b>	
TOUCH POWER <small>(Not available)</small>	
EXTERNAL CONTROL	When ON is set, the monitor can be controlled by a device connected to USB2 port.
PC SOURCE	Select a device connected to USB1 which controls the monitor. If a control device is specific, select EXTERNAL PC or OPTION. OPTION is only available when slot 2 type PC option is connected to the monitor.
USB POWER	Selects a power relation of USB CM1 (2A). Set ON to supply the power to the USB CM1 (2A). NOTE: Power consumption depends on which USB devices are connected to the monitor.
<b>CEC</b>	
	This function enables you to control the HDMI CEC compliant device connected via HDMI connector. CEC is an abbreviation of Consumer Electronics Control.
CEC	When ON is set, please set items below. NOTE: If ON is selected, the below functions are activated. Depending on the connected device, the device may not work properly. When the connected HDMI CEC device receives a play command, the monitor synchronously turns on then changes the input signal to HDMI. If the monitor has been turned on, when a connected HDMI CEC device receives a play command, input signal is switched to HDMI. The connected HDMI CEC devices are controlled by the wireless remote control supplied with the monitor.
AUTO TURN OFF	When the monitor goes to standby via remote control or the power button on the monitor, a connected HDMI CEC device go to standby synchronously. NOTE: If the connected HDMI CEC device is recording, the device does not go into standby.
AUDIO RECEIVER	Activates HDMI CEC audio amplifier. If YES is set, outputs the sounds of the connected HDMI CEC device from the connected HDMI CEC audio amplifier. If YES is set, the internal speaker or the external speaker connected to the monitor is set to mute. NOTE: When an HDMI CEC audio amplifier is connected, set to YES. Please set to NO if there is no connected HDMI CEC audio device to the monitor.
SEARCH DEVICE	Searches the HDMI CEC device connected to the monitor. When search is successful, the connected HDMI CEC device's type and registered device name are shown. When search has been completed or failed, the SEARCH DEVICE is set to NO automatically. To retry the SEARCH DEVICE, set it to YES again. After detecting HDMI CEC devices, you can switch the device input by selecting the device.
RESET	Resets all the settings within the CONTROL menu back to factory setting except for LAN, CHANGE PASSWORD, SECURITY and PING.
<b>OPTION</b>	
OPTION POWER	Allows the monitor to supply power to an Option Board slot during power save mode or standby mode. AUTO: Power supply depends on whether or not an Option Board is connected. ON: Supply power to the connected option continues during power save mode or standby mode. OFF: Supply power to the connected option stops during power save mode or standby mode. NOTE: To activate Power management function with no signal input from the inserted slot 2 type option, please set OPTION POWER to AUTO or ON.
AUDIO*1	Selects the sound input signal according to the slot2 type option specifications. To activate DIGITAL, select OPTION for input signal and OPTION for AUDIO INPUT. NOTE: DIGITAL is activated only when OPTION is selected for input signal and OPTION for AUDIO INPUT.
<b>INTERNAL PC*1</b>	
OFF WARNING <small>(Not adjustable)</small>	
AUTO OFF	Monitor power is automatically off when the internal PC is off or the monitor is in power save mode. NOTE: If you select OFF, the monitor power is not automatically on when the internal PC is on.
START UP PC	When ON is selected, the internal PC will start.
FORCE QUIT	When ON is selected, a forced shutdown of the internal PC will be carried out. Please use this function only when the operating system cannot be shut down manually.

\*1: This function depends on which Option Board you are using. When changing the setting, turn the monitor's main power switch off and on again.

SLOT2 CH SETTING	Selects signal type according to the slot 2 type option specifications.
AUTO	Sets the signal type automatically.
1CH	Fills the screen entirely with the signal which is selected in SLOT2 CH SELECT.
2CH	The DisplayPort signal is displayed on the left half of the screen, the TMDS signal is displayed on the right half. If the internal PC does not support either one of the signal types, the existing signal will automatically be displayed on the full screen.
SLOT2 CH SELECT	This function is available only when SLOT2 CH SETTING is 1CH.
DisplayPort	Shows the DisplayPort signal from a slot 2 type PC option on the full screen.
TMDS	Shows the TMDS signal from a slot 2 type PC option on the full screen.
RESET	Resets the AUDIO setting back to the factory setting within the OPTION menu.
<b>SYSTEM</b>	
MONITOR INFORMATION	Shows the model name, serial number and firmware version of your monitor. CARBON SAVINGS: Display the estimated carbon saving information in kg-CO2. The carbon footprint factor in the carbon saving calculation is based on the OECD (2008 Edition). CARBON USAGE: Display the estimated carbon usage information in kg-CO2. This is the arithmetic estimation, not actual measurement value. This estimation is based without any options.
FIRMWARE	Displays firmware version that is installed to the monitor.
MAC ADDRESS	Displays the MAC ADDRESS.
FACTORY RESET	All items are returned to factory shipment state. NOTE: You can reset all items in all daisy chained monitors. Please be careful to avoid resetting all items inadvertently.
<b>COMPUTE MODULE</b>	
COMPUTE MODULE	When a Raspberry Pi Compute Module Interface Board and Raspberry Pi Compute Module are installed, additional OSD menu items will be available for configuring the related settings. Please do not change settings in COMPUTE MODULE yourself.
POWER	
POWER SUPPLY	Controls power to the Compute Module.
AUTO POWER ON	When set to ENABLE, power to the Compute Module will be turned on automatically when the display power is turned on.
SERVICE MENU	
SETTING LOCK	Locks all settings under COMPUTE MODULE.
USB BOOT MODE	When set to ENABLE, the Compute Module will appear as a USB device to a PC connected to the USB2 input on the display and can be programmed with an Operating System. When set to DISABLE, the Compute Module will boot normally.
IR SIGNAL	Enables or disables the forwarding of IR remote control signals.
MONITOR CONTROL	Enables or disables the internal serial connection between the display and Compute Module.
SHUTDOWN SIGNAL	Enables or disables the use of GPIO 23 to signal that power to the compute module will be shutting down.
POWER SUPPLY OFF DELAY	This sets the time delay after the Shutdown Signal is set until the power to the Compute Module is turned off. Configure this to allow adequate time for any software to shutdown safely.
WDT	Enables or Disables the display's built in Watchdog Timer function for the Compute Module.
START UP TIME	This sets the time delay for when the display should start receiving WDT reset commands.
PERIOD TIME	This sets the maximum amount of time within which the display must receive WDT reset commands from the Compute Module.
CHANGE PASSWORD	

Default values can be provided on request.

## NOTE 1: CREATING A SCHEDULE

The schedule function allows the monitor to be set to power on or to be on standby at different times. Up to seven different schedules can be programmed.

To program the schedule:

1. Enter the SCHEDULE menu. Highlight SCHEDULE SETTINGS using the up and down buttons. Press the SET/POINT ZOOM or the + button to enter the Settings menu. Highlight the desired schedule number and press SET/POINT ZOOM. The box next to the number will turn yellow. The schedule can now be programmed.
2. Use the down button to highlight the POWER. Use the + and - buttons to set ON. To set power off schedule, set OFF.
3. Use the down button to highlight the TIME. Use the + and - buttons to set the time.
4. Use the up and down arrows to highlight INPUT. Use the + and - buttons to choose the input source. Use the up and down arrows to highlight PIC. MODE. Use the + and - buttons to choose the picture mode.
5. Use the down button to select DATE, EVERY DAY, EVERY WEEK, WEEKDAY, WEEKEND or HOLIDAY. Push the SET/POINT ZOOM button on a menu, which is suitable for the schedule. If the schedule is to be run on a specific day, choose DATE and press the SET/POINT ZOOM button. If the schedule is to be run every day, choose EVERY DAY and press the SET/POINT ZOOM button. The circle next to EVERY DAY will turn yellow. If a weekly schedule is desired, choose the days of the week using the up and down buttons and pressing SET/POINT ZOOM to select. Then highlight the EVERY WEEK option and press SET/POINT ZOOM. Please set WEEKDAY, WEEKEND, or HOLIDAY in the same manner. The WEEKDAY, WEEKEND and HOLIDAY settings are available under the SCHEDULE SETTINGS (See [page 36](#)).
6. After a schedule is programmed, the remaining schedules can then be set. Press MENU to leave the OSD or press EXIT to go back to the previous menu.

**NOTE:** If schedules are overlapping, the schedule with the highest number will have priority over the schedule with the lowest number. For example, schedule #7 will have priority over schedule #1.

If a selected input or picture mode is not available now, the disabled input or picture mode is shown in red.

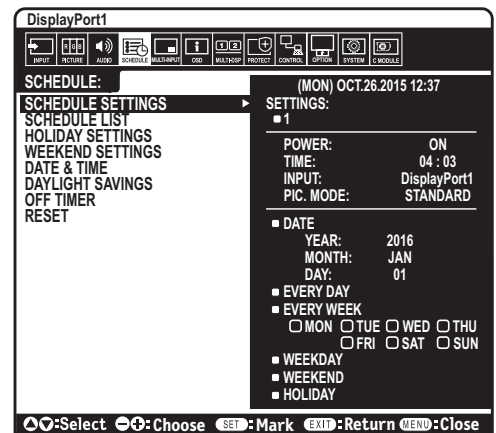

## NOTE 2: IMAGE PERSISTENCE

Please be aware that LCD Technology may experience a phenomenon known as Image Persistence. Image Persistence occurs when a residual or "ghost" image of a previous image remains visible on the screen. Unlike CRT monitors, LCD monitors' image persistence is not permanent, but constant images being displayed for a long period of time should be avoided.

To alleviate image persistence, turn off the monitor's main power or set it to standby for as long as the previous image was displayed. For example, if an image was on the monitor for one hour and a residual image remains, the monitor's main power should be turned off or set it to standby for one hour to erase the image.

As with all personal display devices, NEC DISPLAY SOLUTIONS recommends displaying moving images and using a moving screen saver at regular intervals whenever the screen is idle, or turn off the monitor's main power or set it to standby when not in use.

Please set "SCREEN SAVER", "DATE & TIME" and "SCHEDULE SETTINGS" functions to further reduce the risk of Image persistence.

## For long life use as a Public Display

### Image Sticking of LCD Panel

When an LCD panel is operated continuously for long hours, a trace of electric charge remains near the electrode inside the LCD and a residual or "ghost" image of the previous image may be observed. (Image Persistence)

Image Persistence is not permanent, but when a fixed image is displayed for long period, ionic impurities inside the LCD are accumulated along the displayed image and may be permanent. (Image Sticking)

### Recommendations

To prevent Image Sticking, and for longer life usage of the monitor, the following is recommended.

- Fixed image should not be reproduced for long period. Change still images after short intervals.
- When not in use, please turn off the monitor via remote control, or use the Power Management function of the PC, or use the built-in Schedule Functions.
- Lower environmental temperatures prolong the lifespan of the monitor. When a protective surface (glass, acrylic) is installed over the monitor's screen surface, the monitor's screen surface is located in an enclosure, or if the monitors are stacked, utilize the temperature sensors inside the monitor. To reduce the internal temperature, use the Cooling Fans, Screen Saver, the Power Management function of the PC and Low Brightness.
- Please use "Screen Saver Mode" of monitor.

# Remote Control Functions

## REMOTE CONTROL ID FUNCTION

### REMOTE CONTROL ID

The remote control can be used to control up to 100 individual MultiSync monitors using what is called the REMOTE CONTROL ID mode. The REMOTE CONTROL ID mode works in conjunction with the Monitor ID, allowing control of up to 100 individual MultiSync monitors. For example, if there are many monitors being used in the same area, a remote control in normal mode would send signals to every monitor at the same time (see Figure 1). Using the remote in REMOTE CONTROL ID mode will only operate one specific monitor within the group (see Figure 2).

### TO SET REMOTE CONTROL ID

While holding down the REMOTE ID SET button on the remote control, use the KEYPAD to input the Monitor ID (1-100) of the monitor to be controlled via remote. The remote can then be used to operate the monitor having that specific Monitor ID number.

When 0 is selected or when the remote control is in normal mode, all monitors will be operated.

### TO SET/RESET REMOTE CONTROL MODE

ID Mode - To enter ID Mode press the REMOTE ID SET button and hold down for 2 seconds.

Normal Mode - To return to Normal Mode press the REMOTE ID CLEAR button and hold down for 2 seconds.

In order for this feature to work properly, the monitor must be assigned a unique Monitor ID number. The Monitor ID number can be assigned under the MULTI DISPLAY menu in the OSD (See [page 40](#)).

Point the remote control towards the remote sensor of the desired monitor and press the REMOTE ID SET button. The MONITOR ID number is shown on the screen when your remote control is in ID mode.

### Use the remote to control all monitors in range

1. On the remote control, press and hold down the REMOTE ID SET button while using the keypad to input the REMOTE CONTROL ID number "0".
2. All monitors within range of the remote control will now respond to keypad press.

**NOTE:** When the REMOTE ID is set to "0", pressing REMOTE ID SET will make all monitors, within range of the remote signal, display their Monitor ID on screen. This way you can easily see what the monitor ID is if you want to control a single monitor, as described below.

### Use the remote control to operate a monitor that has a specific MONITOR ID number assigned to it.

1. Set the MONITOR ID number for the monitor (See [page 40](#)). The MONITOR ID number can range from 1-100. This MONITOR ID number allows the remote control to operate this specific monitor without affecting other monitors.
2. On the remote control, press and hold down the REMOTE ID SET button while using the keypad to input the REMOTE CONTROL ID number (1-100). The REMOTE ID NUMBER should match the MONITOR ID number of the monitor to be controlled.
3. Point the remote control towards the remote sensor of the desired monitor and press the REMOTE ID SET button. The MONITOR ID number is shown in red on the monitor. If the REMOTE CONTROL ID is "0", then all monitors in range will show their respective MONITOR ID number in red.

If the MONITOR ID number is shown in white on the monitor, the MONITOR ID number and the REMOTE CONTROL ID are not the same.

**NOTE:** The GROUP ID cannot be specified via the remote control.

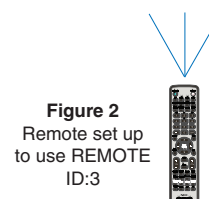
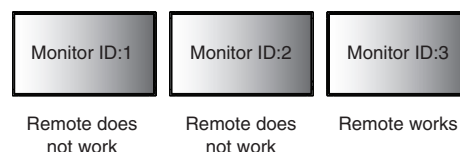
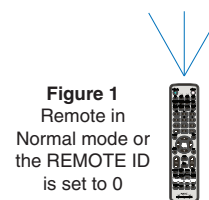
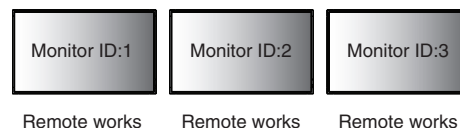

# Multiple Monitors Connection

You can control multiple monitors by using RS-232C, REMOTE IN or LAN daisy-chain connection.

**NOTE:** Multiple monitors that are daisy-chained have a limit to the connectable monitors.  
Please execute AUTO ID (see [page 40](#)) before manually specifying the ID number or control by the specified ID number.

Main Monitor		Sub Monitors	
Connector		Connector	
IN	OUT	IN	OUT
RS-232C	LAN2	LAN1	LAN2
REMOTE IN			
LAN1			

## Connection

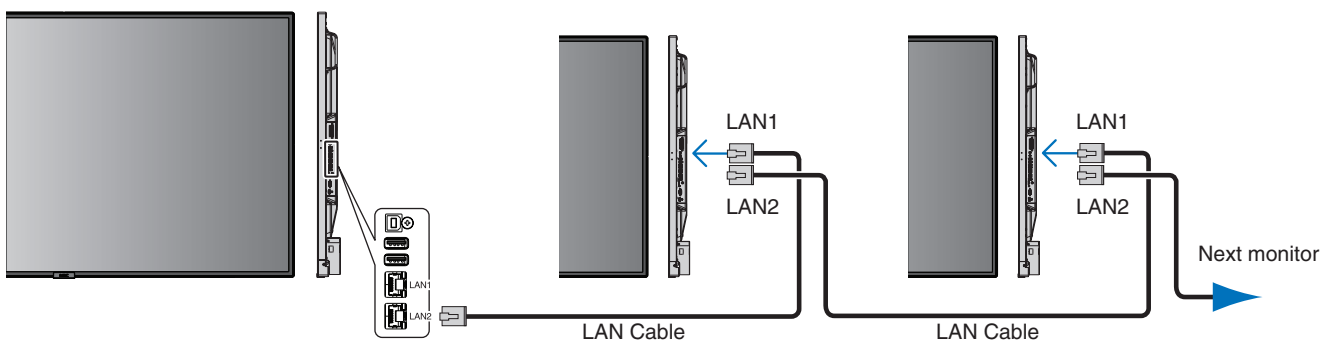

# Controlling the LCD monitor via RS-232C Remote Control

This monitor can be controlled by connecting a personal computer with an RS-232C (reverse type) terminal.

For example, some of the functions that can be controlled by a personal computer are:

- Power ON or standby.
- Switching between input signals.
- Sound Mute ON or OFF.

## Connection

Monitor + computer.

- Please turn off the monitor's main power before connecting a computer to the monitor.
- Please turn on the connected computer first then turn on the monitor's main power.  
If you turn on the computer and monitor in reverse order, the com port may not work.
- When controlling the monitor connected with an RS-232C cable, please refer to the Control command (See [page 57](#)) or see the "External\_Control.pdf" file on the CD-ROM supplied with the monitor.

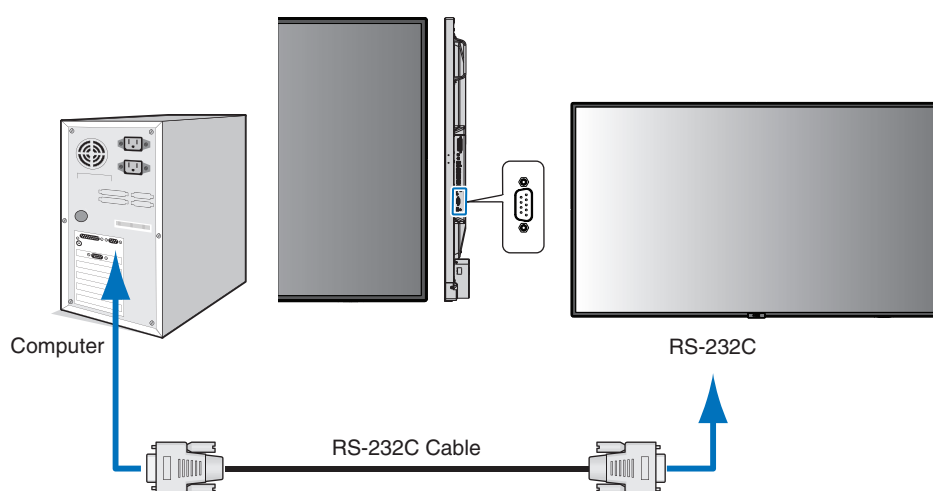

**NOTE:** If your computer is equipped only with a 25-pin serial port connector, a 25-pin serial port adapter is required. Contact your supplier for details.  
For the pin assignment, please see "2) RS-232C input/output" on [page 50](#).

To control the monitor, please use the control command. Instructions for the control command can be found on the CD-ROM supplied with the monitor. The file is called "External\_control.pdf".

1) Interface

PROTOCOL	RS-232C
BAUD RATE	9600 [bps]
DATA LENGTH	8 [bits]
PARITY	NONE
STOP BIT	1 [bit]
FLOW CONTROL	NONE

This LCD monitor uses RXD, TXD and GND lines for RS-232C control.  
The reverse type cable (null modem cable) (not included) should be used for RS-232C control.

2) PIN ASSIGNMENT

RS-232C input/output

Pin No	Name
1	NC
2	RXD
3	TXD
4	NC
5	GND
6	NC
7	NC
8	NC
9	NC

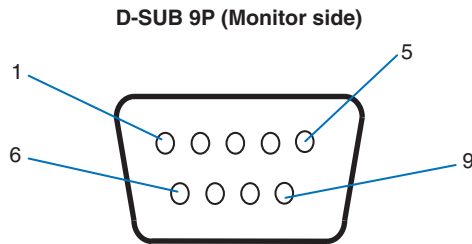

This LCD monitor uses RXD, TXD and GND lines for RS-232C control.



# Controlling the LCD monitor via LAN Control

## Connecting to a Network

Using a LAN cable allows you to specify the Network Settings and the Alert Mail Settings by using an HTTP server function.

To use a LAN connection, you are required to assign an IP address. The monitor will obtain an IP address automatically when connected to a DHCP network.

### Example of LAN connection:

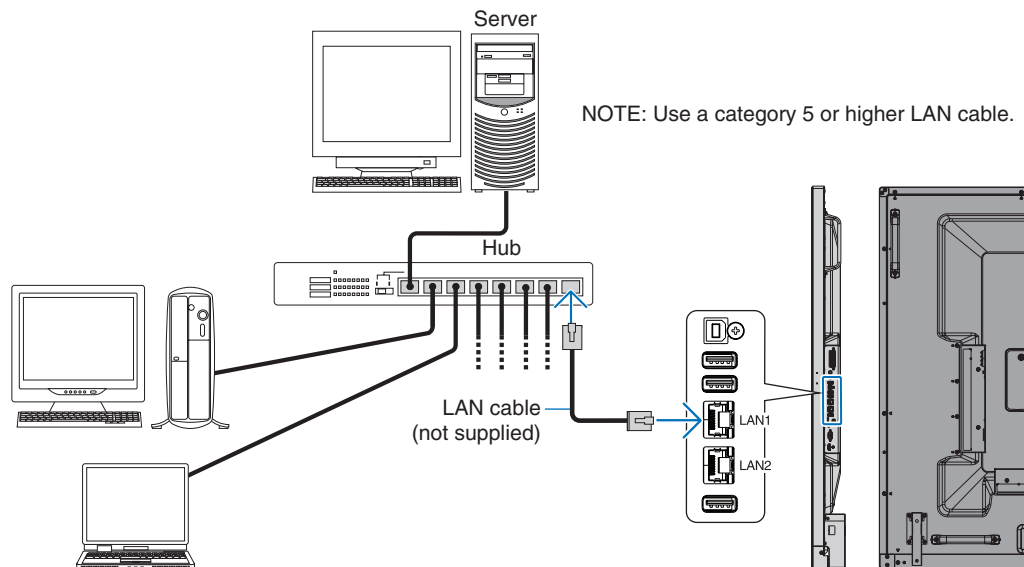

## Network Setting by Using an HTTP Browser

### Overview

Connecting the monitor to a network allows for remote control of the monitor from a computer connected to the network.

The IP address and subnet mask of the monitor can be set on the NETWORK SETTINGS screen of the web browser by using an HTTP server. Please be sure to use "Microsoft Internet Explorer 10" or a higher version for the web browser.

(This device uses "JavaScript" and "Cookies" and the browser should be set to accept these functions. The setting method will vary depending on the version of the browser. Please refer to the help files and the other information provided in your software.)

To access the HTTP server, launch a web browser on a computer connected to the same network as the monitor and enter the following URL in the web address field.

### Network Setting

`http://<the Monitor's IP address>/index.html`

**HINT:** The default IP address is assigned automatically to the monitor.  
The exclusive application can be downloaded from our website.

**NOTE:** If the NETWORK SETTINGS screen does not appear in the web browser, press the Ctrl+F5 keys to refresh your web browser (or clear the cache).

If the monitor appears to be slow in response to commands or clicks on buttons in the browser, or the general speed of operation is unacceptable, this may be due to network traffic or the settings on your network. Should this happen, consult your network administrator.

The monitor may not respond if the buttons shown on the browser are repeatedly pressed in rapid intervals. Should this happen, wait a moment and repeat. If you still can't get a response, turn the monitor off and then back on.

To control a monitor please use the control command. See "Control command" ([page 57](#)).

## Preparation Before Use

Connect the monitor to the network, using a commercially available LAN cable, before attempting to use browser operations.

Operation with a browser that uses a proxy server may not be possible depending on the type of proxy server and the setting method. Although the type of proxy server will be a factor, it is possible that items that have been set will not be shown, depending on the effectiveness of the cache, and the contents set from the browser may not be reflected in operation. It is recommended that a proxy server is not used unless the network environment requires it.

## Handling of the Address for Operation via a Browser

A host name can be used in the following cases (corresponding to the IP address of the monitor):

The host name must be registered in the domain name server (DNS) by the network administrator. You can then access the network settings of the monitor via this registered host name by using a compatible browser.

If the host name has been configured in the "HOSTS" file of the computer being used, you can then access the network settings of the monitor via this host name by using a compatible browser.

**Example 1:** When the host name of the monitor has been set to "pd.nec.co.jp", access is gained to the network setting by specifying *http://pd.nec.co.jp/index.html* for the address or the entry column of the URL.

**Example 2:** When the IP address of the monitor is "192.168.73.1", access is gained to the mail alert settings by specifying *http://192.168.73.1/index.html* for the address or the entry column of the URL.

## Operation

Access the following address to show HOME.

<http://<the Monitor's IP address>/index.html>

Click each link on the left column below HOME.

## REMOTE CONTROL

Enable an operation to control the monitor equivalent to the keys on the remote control.

## OSD menu

Enable the operation to set the following OSD menu:

INPUT, PICTURE, AUDIO, SCHEDULE, MULTI INPUT, OSD, MULTI DISPLAY, DISPLAY PROTECTION, CONTROL, OPTION, SYSTEM.

**NOTE:** Function of buttons which are shown on setting pages.

[APPLY]: Save your settings.

[CANCEL]: Return to the previous settings. **NOTE:** CANCEL is disabled after clicking APPLY.

[RELOAD]: Reload the settings.

[RESET]: Resets to the initial setting.

# Network Settings

Click on "NETWORK" on the left column below HOME.

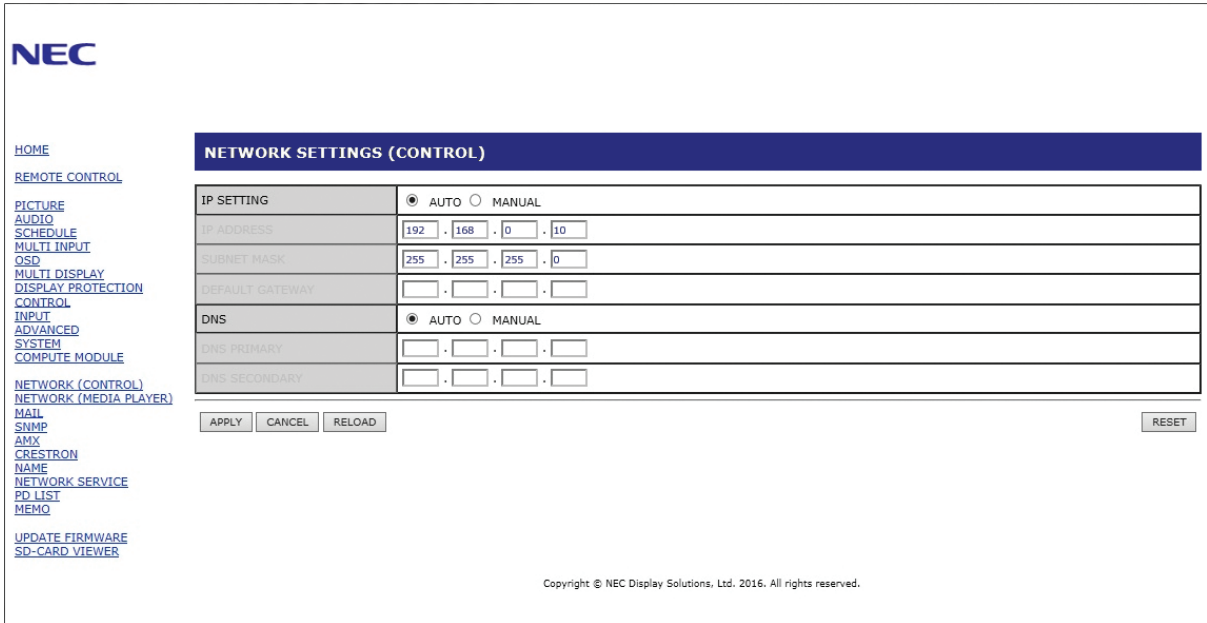

IP SETTING	Select an option for setting the IP ADDRESS. AUTO: Automatically assign an IP address. MANUAL: Manually set an IP address for the monitor connected to the network. NOTE: Consult your network administrator if you have any trouble.
IP ADDRESS	Set your IP address for the monitor connected to the network when [MANUAL] is selected for [IP SETTING].
SUBNET MASK	Set your subnet mask data for the monitor connected to the network when [MANUAL] is selected for [IP SETTING].
DEFAULT GATEWAY	Set your default gateway for the monitor connected to the network when [MANUAL] is selected for [IP SETTING]. NOTE: Set as [0.0.0.0] to delete the setting.
DNS	Set for IP ADDRESS setting of DNS server. AUTO: The DNS server connected to the monitor will automatically assign its IP address. MANUAL: Manually enter the IP address of the DNS server that is connected with the monitor.
PRIMARY DNS	Enter the primary DNS server settings of the network connected with the monitor. NOTE: Enter [0.0.0.0] to delete the setting.
SECONDARY DNS	Enter the secondary DNS server settings of the network connected with the monitor. NOTE: Enter [0.0.0.0] to delete the setting.

**NOTE:** The following settings will be set back to the factory settings when IP ADDRESS RESET is selected at CONTROL of the OSD:  
 [IP SETTING]: AUTO, [IP ADDRESS]: 192.168.0.10, [SUBNET MASK]: 255.255.255.0, [DNS]: AUTO, [DEFAULT GATEWAY], [PRIMARY DNS] and [SECONDARY DNS] are blank.

## Mail Setting

Click on "MAIL" on the left column below HOME.

When the Mail settings are configured and enabled, the monitor sends email notifications when an error occurs or if the input signal is lost. The monitor must be connected to a LAN for this feature to work.

ALERT MAIL	When an error occurs, the monitor will send an error message to the email address(es) listed in the Recipient's Address fields. Please see the "Alert error message list" table below. Note that it is not an error when no input signal is detected. The monitor will only send a no signal input notification email when Status Message is enabled. Selecting [ENABLE] turns on the Alert Mail feature. Selecting [DISABLE] turns off the Alert Mail feature.
STATUS MESSAGE	When there is no input signal, the monitor will send a no signal detected notification to the email address(es) listed in the Recipient's Address fields. Note that this option does not send notifications of any errors that occur. The monitor will only send error notifications when Alert Mail is enabled. Selecting [ENABLE], Alert Mail send mails when the monitor is no signal or in alerting conditions. Selecting [DISABLE], Alert Mail send mails when the monitor is in alerting conditions. It doesn't send mail when the monitor is no signal.
SENDER'S ADDRESS	Type in the sender's address. Up to 60 alphanumeric and symbols characters can be used.
SMTP SERVER	Type in the SMTP server name to be connected with the monitor. Up to 60 alphanumeric characters can be used.
RECIPIENT'S ADDRESS 1 TO 3	Type in your recipient's address. Up to 60 alphanumeric and symbols characters can be used.
AUTHENTICATION METHOD	This selects the authentication method of the email transmission.
POP3 SERVER	This specifies the address of the POP3 server that is used in the authentication of the email.
USER NAME	This sets the user name for logging into the authentication server when authentication is required for the email transmission. Up to 60 alphanumeric characters can be used.
PASSWORD	This sets the password for logging into the authentication server when authentication is required for the email transmission. Up to 60 alphanumeric characters can be used.
TEST MAIL	Click on this button to send a test email to check if your settings are correct.

- NOTE:**
- If an alert email isn't received when performing a Test Mail, check that the network, server settings and the recipient's email address are correct.
  - If you entered an incorrect address in a test, you may not receive an Alert email. Should this happen, check that the Recipient's Address is correct.

**HINT:** For the control command diagram, please see the file "External\_Control.pdf" on the CD-ROM supplied with this monitor.

### Alert error message list

Error number * ErrorCode	Alert mail Message	Explanation	Measure
70h ~ 7Fh	The monitor's power supply is not functioning normally.	Standby power abnormal	Please contact your supplier.
80h ~ Fh	The cooling fan has stopped.	Cooling fan abnormal	Please contact your supplier.
90h ~ 9Fh	The monitor's backlight unit is not functioning normally.	Backlight abnormal	Please contact your supplier.
A0h ~ AFh	The monitor is overheated.	Temperature abnormal	Please contact your supplier.
A2h		A Sensor reached the temperature limit which was specified in the OSD. *Condition: DISPLAY PROTECTION-FAN CONTROL-COOLING FAN = AUTO	Reconfirm the settings in the OSD (DISPLAY PROTECTION-FAN CONTROL) or please contact your supplier.
B0h ~ BFh	The monitor does not receive an input signal.	No signal	Please check "No picture" in "Troubleshooting".
D0h	The remaining capacity of the error log decreased.	The Proof of Play log memory size is 1 more hour.	Please get a log by using PD external command. See <a href="#">page 56</a> .
D1h	The battery for clocks is empty.	The battery is empty.	Please connect the monitor to the power then recharge the battery. Please set (DATE & TIME) in OSD.
E0h ~ EFh	A system error occurred in the monitor.	System error.	Please contact your supplier.

## SNMP Settings

Click on "SNMP" on the left column below HOME.

The SNMP protocol is used to get status information and to control a monitor directly via the network.

### Version:

SNMP v1 Authenticated plaintext by community name, does not return a confirmation message of the trap.

SNMP v2c Authenticated plaintext by community name, returns a confirmation message of the trap.

### Community name:

The default setting of community name is "public". It is read only. You can set community names for up to 3 settings.

### Trap:

Sending error message to a specified address when an error occurs in the monitor.

Check Box	Explanation	Error code
Temperature	Temperature abnormal	0xA0, 0xA1, 0xA2
Fan	Cooling fan abnormal	0x80, 0x81
Power	Power abnormal	0x70, 0x71, 0x72, 0x78
Inverter/Backlight	Inverter or backlight abnormal	0x90, 0x91
No Signal	No signal	0xB0
PROOF OF PLAY	Lower the log storage	0xD0
System Error	System error	0xE0

## AMX Settings

Click on "AMX" on the left column below HOME.

AMX BEACON	<p>To turn on or off for the detection from AMX Device Discovery when connecting to a network supported by an AMX's NetLinx control system.</p> <p><i>HINT:</i>            When using a device that supports AMX Device Discovery, all AMX NetLinx control systems will recognize the device and download the appropriate Device Discovery Module from an AMX server. Selecting [ENABLE] AMX Device Discovery will detect the device.            Selecting [DISABLE] AMX Device Discovery will not detect the device.</p>
------------	---

## CRESTRON Settings

Click on "CRESTRON" on the left column below HOME.

### CRESTRON ROOMVIEW compatibility

The monitor supports CRESTRON ROOMVIEW, allowing multiple devices connected in the network to be managed and controlled from a computer or a controller.

For further information, visit <http://www.crestron.com>

ROOMVIEW	ROOMVIEW for managing from the computer. ON: Enables ROOMVIEW. OFF: Disables ROOMVIEW.
CRESTRON CONTROL	CRESTRON CONTROL for managing from the controller. ON: Enables CRESTRON CONTROL. OFF: Disables CRESTRON CONTROL.
CONTROLLER IP ADDRESS	Sets the IP address of the CRESTRON SERVER.
IP ID	Sets your CRESTRON SERVER IP ID.

**HINT:** The CRESTRON settings are required only for use with CRESTRON ROOMVIEW.

For further information, visit <http://www.crestron.com>

## Name Settings

Click on "NAME" on the left column below HOME.

MONITOR NAME	Defines a monitor name. The name must be max. 16 characters long. The default is the model name.
HOST NAME (CONTROL)	Type in the hostname of the monitor which is connected to the network. Up to 15 alphanumeric characters can be used.
HOST NAME (MP)	Type in the hostname of the network to be used in the Media Player connected to the monitor. Up to 15 alphanumeric characters can be used.
DOMAIN NAME	Type in the domain name of the network which is connected with the monitor. Up to 60 alphanumeric characters can be used.

## Network Password Settings

Click on "NETWORK SERVICE" on the left column below HOME.

PJLink CLASS	Set a class for PJLink*. NOTE: PJLink is a network interface standard that JBMIA established. <a href="http://pjlink.jbmia.or.jp/index.html">http://pjlink.jbmia.or.jp/index.html</a> This monitor is available for class1 and class2 command.
NOTIFY FUNCTION ENABLE	Enable or disable a notification of the monitor network condition. This function is only for class2.
NOTIFY ADDRESS	Set an IP ADDRESS to which the monitor network status will be sent. This function is only for class2.
PJLink PASSWORD	Set a password for PJLink*. The password must be max. 32 characters long. Do not forget your password. If you forget your password, consult your supplier.
HTTP PASSWORD	Set a password for the HTTP server. The password must be max. 10 characters long.
HTTP PASSWORD ENABLE	An HTTP PASSWORD is required when logging into the HTTP server. Set the monitor name as the USER NAME when entering the password.

\*What is PJLink?

PJLink is a standardization of protocol used for controlling devices of different manufacturers. This standard protocol was established by Japan Business Machine and Information System Industries Association (JBMIA) in 2005. The device supports all commands of PJLink.

## PD LIST Information

Click on "PD LIST" on the left column below HOME.

Shows a list of monitor IDs and IP addresses of multiple monitors which are daisy-chained.

**NOTE:** Only the master monitor can show the list.

## MEMO Settings

Click on "MEMO" on the left column below HOME.

Use the MEMO settings to define text that can be viewed on-screen when a user selects MEMO in the OSD menu. For example, if you want to provide contact information for customer service at your company, that information can be entered here.

Note that the MEMO text cannot be set from the monitor's OSD menu using the remote control. The MEMO text must be added in the fields in this section. The message is displayed on the monitor screen.

TITLE	The title must be max. 24 characters long.
MESSAGE	A message must be max. 240 characters long.
MEMO PASSWORD	The default is "0000".
MEMO PASSWORD ENABLE	A MEMO PASSWORD is required when selecting MEMO PASSWORD ENABLE.

## SD-CARD VIEWER setting

Click "SD-CARD VIEWER" on the left side of HOME.

Please refer to Using SHARED SD card SETTINGS (See [page 27](#)).

## External Control

### Connecting external device

There are two options to connect an external device to the monitor.

- RS-232C terminal.  
Connecting an external device to the RS-232C terminal of the monitor with a RS-232C cable.
- LAN port.  
Connecting an external device to the LAN port of the monitor with a LAN cable.  
For further information regarding the type of LAN cable to use, please consult your network administrator.

## Connecting interface

### RS-232C Interface

PROTOCOL	RS-232C
BAUD RATE	9600 [bps]
DATA LENGTH	8 [bits]
PARITY	NONE
STOP BIT	1 [bit]
FLOW CONTROL	NONE

### LAN interface

PROTOCOL	TCP
PORT NUMBER	7142
COMMUNICATION SPEED	AUTO setting (10/100Mbps)

## Control command

For other commands, please see “External\_Control.pdf” file on the CD-ROM supplied with the monitor.

Function (Monitor ID = 1)	Code Data
Power ON	01 30 41 30 41 30 43 02 43 32 30 33 44 36 30 30 30 31 03 73 0d
Power OFF	01 30 41 30 41 30 43 02 43 32 30 33 44 36 30 30 30 34 03 76 0d
Input Source Select DisplayPort1	01 30 41 30 45 30 41 02 30 30 36 30 30 30 30 46 03 04 0d or 01 30 41 30 45 30 41 02 31 31 30 36 30 30 30 46 03 04 0d
Input Source Select DisplayPort2	01 30 41 30 45 30 41 02 30 30 36 30 30 30 31 30 03 73 0d or 01 30 41 30 45 30 41 02 31 31 30 36 30 30 31 30 03 73 0d
Input Source Select HDMI1	01 30 41 30 45 30 41 02 30 30 36 30 30 30 31 31 03 72 0d or 01 30 41 30 45 30 41 02 31 31 30 36 30 30 31 31 03 72 0d
Input Source Select HDMI2	01 30 41 30 45 30 41 02 30 30 36 30 30 30 31 32 03 71 0d or 01 30 41 30 45 30 41 02 31 31 30 36 30 30 31 32 03 71 0d
Input Source Select HDMI3	01 30 41 30 45 30 41 02 30 30 36 30 30 30 38 32 03 78 0d or 01 30 41 30 45 30 41 02 31 31 30 36 30 30 38 32 03 78 0d
Input Source Select MP	01 30 41 30 45 30 41 02 30 30 36 30 30 30 38 37 03 7D 0d or 01 30 41 30 45 30 41 02 31 31 30 36 30 30 38 37 03 7D 0d
Input Source Select OPTION	01 30 41 30 45 30 41 02 30 30 36 30 30 30 30 44 03 06 0d or 01 30 41 30 45 30 41 02 31 31 30 36 30 30 30 44 03 06 0d
Sound Mute ON	01 30 41 30 45 30 41 02 30 30 38 44 30 30 30 31 03 09 0d
Sound Mute OFF	01 30 41 30 45 30 41 02 30 30 38 44 30 30 30 32 03 0a 0d

## ASCII Control command

This monitor supports control command, which is listed in the “External\_Control.pdf” file on the CD-ROM supplied with the monitor, but also supports common ASCII control command, which is used for controlling the NEC monitor or projector from a connected PC. For further information please visit our website.

### Parameter

#### Input command

Input signal name	Response	Parameter
DisplayPort1	DisplayPort1	DisplayPort1 or DisplayPort
DisplayPort2	DisplayPort2	DisplayPort2
HDMI1	hdmi1	hdmi1 or hdmi
HDMI2	hdmi2	hdmi2
HDMI3	hdmi3	hdmi3
MP	mp	mp
OPTION	option	option

#### Status command

Response	Error status
error:temp	Temperature abnormal
error:fan	Cooling fan abnormal
error:light	Inverter or backlight abnormal
error:system	System error

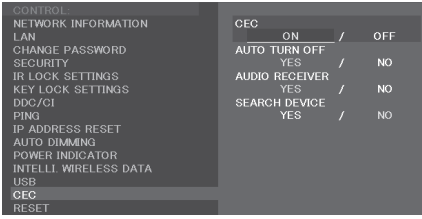

## Supporting HDMI CEC Command

OSD menu	HDMI CEC command name	Explanation	Setting
CEC (Consumer Electronics Control)	One Touch Play	If HDMI CEC supporting devices are turned on, the monitor connected to the devices by HDMI cable is also turned on automatically. After that, the input switches to HDMI from an input, which you selected. If the monitor is turned on when HDMI CEC devices are turned on, it changes the input from the original one to HDMI.	 <p>To set CEC menus please follow the steps below.</p> <p>By using ▲▼ buttons select CONTROL &gt; CEC then press SET/POINT ZOOM button on the CEC.</p> <p>By using + - buttons select ON then press SET/POINT ZOOM button on the ON.</p>
	Remote Control Pass Through	The monitor's wireless remote control button operation is functioning to HDMI CEC supporting devices. For example, if turning on the monitor by wireless remote control and pressing the play button, HDMI CEC supporting devices will also be turned on and play.	
	Power Status	Connected HDMI CEC supporting devices obtains the monitor's power status, such as the monitor is in standby mode or on.	
	System Information	This function obtains the information of a connected HDMI CEC supported device (CEC version, Physical Address). In addition, this function copes with "Change Language function". If the language for the monitor is changed, the language for a connected HDMI CEC supported device is changed to the same language, which is selected for the monitor. For the "Change Language function", it is necessary that the connected HDMI CEC supported device be able to cope with multi-language.	
AUTO TURN OFF	System Standby	If the monitor is set to standby using the wireless remote control supplied with the monitor, HDMI CEC supported devices also go into standby at the same time. If the monitor goes into standby while an HDMI CEC supported device is recording, the device is kept on. Please refer to the user's manual supplied with the HDMI CEC supported device for further information.	<p>By using ▲▼ buttons select AUTO TURN OFF then press SET/POINT ZOOM.</p> <p>By using + - buttons select YES then press SET/POINT ZOOM button on the YES.</p>
AUDIO RECEIVER	System Audio Control	The function sends digital audio signal through the HDMI cable. Please set an HDMI CEC audio amplifier between the monitor and an HDMI CEC supported device with an HDMI cable. The Volume button on the wireless remote control supplied with the monitor is also controlling the volume of the connected HDMI CEC audio amplifier. While this function is active, the internal speaker or external speaker connected to the monitor is set to MUTE automatically.	<p>By using ▲▼ buttons select AUDIO RECIEVER then press SET/POINT ZOOM.</p> <p>By using + - buttons select YES then press SET/POINT ZOOM button on the YES.</p>
SEARCH DEVICE	Device OSD Name Transfer	This function obtains the connected HDMI CEC supported device's name.	By using ▲▼ buttons select SEARCH DEVICE then press SET/POINT ZOOM.
	Routing Control	By selecting a device name, the HDMI CEC supported device input switches to the input you selected. After selecting the device, wireless remote control operation is functioning for the selected device.	By using + - buttons select YES then press SET/POINT ZOOM button on the YES.

This CEC function supports Feature Abort. We recommend that connecting this monitor to a device supporting HDMI CEC. Please refer to Connections (See [page 17](#)) for HDMI CEC devices connection.



# POINT ZOOM



Using the “SET/POINT ZOOM” button on the remote control enlarges part of the screen image. Press the CH+/- button to zoom in or out. The image can be expanded up to 10 times.

- 1 Press the [SET/POINT ZOOM] button on the remote control. The icon looks like a magnifier.
- 2 Move the magnifier icon with the [▲] [▼] [+] [-] buttons.
- 3 Press the [CH+] to zoom in. Press [CH-] to zoom out.
- 4 Press the [SET/POINT ZOOM] to let the icon disappear.
- 5 Press the [EXIT] to return to the normal image size.
- 6 Press the [MENU] to open the OSD menu.

- NOTE:**
- When using this function, the image may look distorted.
  - This function is not available when set to IMAGE FLIP (except for NONE), MULTI PICTURE MODE, SCREEN SAVER, SUPER in INPUT CHANGE, TILE MATRIX and TEXT TICKER.
  - When DYNAMIC or ZOOM is selected in ASPECT, the image will change to FULL. Then start with POINT ZOOM. After exiting POINT ZOOM, ASPECT will return to the previous ASPECT settings. When ASPECT is changed during the POINT ZOOM operation, DYNAMIC and ZOOM will be set to FULL image.
  - The magnifier icon does not move to a no image area.
  - POINT ZOOM returns to the normal image size after changing the input signal or when the monitor is powered off.
  - POINT ZOOM will become inactive when changing the ASPECT setting during the POINT ZOOM operation.
  - When the POINT ZOOM is active, the STILL function is not available.
  - POINT ZOOM is not available when MODE2 in HDMI in TERMINAL MODE and with a 3840 x 2160 (60 Hz) DisplayPort signal.

# PROOF OF PLAY

This function allows sending of messages for the current status of the monitor by self-diagnosis.

Check item		Message
①	INPUT	DisplayPort1, DisplayPort2, HDMI1, HDMI2, HDMI3, OPTION*, MP
②	Resolution	ex. (H)1920, (V)1080 , (H)1360, (V)768 or No signal or Invalid signal
③	AUDIO INPUT	IN, DisplayPort1, DisplayPort2, HDMI1, HDMI2, HDMI3, OPTION*, MP
④	Audio signal	Audio in or No Audio in or N/A (IN, OPTION (analog)*)
⑤	Picture Image	Normal Picture or No Picture
⑥	AUDIO OUT	Normal Audio or No Audio
⑦	TIME	(year)/(month)/(day)/(hour)/(minutes)/(second)
⑧	EXPANSION DATA	00h: Normal Proof of Play event 01h: Proof of Play event is "last power on time" 10h: MEDIA PLAYER is stop 11h: MEDIA PLAYER is start 12h: MEDIA PLAYER is pause 13h: MEDIA PLAYER error occur 20h: Contents Copy from USB 21h: Contents Copy form network folder 30h: Contents Copy Success 31h: Contents Copy Error (No media) 32h: Contents Copy Error (Connect error) 33h: Contents Copy Error (Out of disk space) 34h: Contents Copy Error (Read/Write error) 40h: Human detected (Human sensor Status) 41h: Human detect cleared (Human Sensor Status)

\*: This function depends on which Option Board installed in the monitor.

### Example:

- ① HDMI1
- ② 1920 x 1080
- ③ HDMI1
- ④ IN1
- ⑤ Normal Picture
- ⑥ Normal Audio
- ⑦ 2014/1/1/0h/0m/0s
- ⑧ 10h: MEDIA PLAYER is stop

**NOTE:** For the Proof of Play function, please see the "External\_Control.pdf" on the CD-ROM supplied with the monitor.

# INTELLIGENT WIRELESS DATA

This function can be used to get the monitor status via wireless communication, even when the main power is off. Some of the OSD options can also be set using this method.

**NOTE:** Sensor position: See [page 10](#) and [page 11](#).  
Please contact your supplier for detailed information.  
Complied with ISO 15693.

Function name
Setting Copy
Setting read and write function
Display information
Security Setting

## MULTIPICTURE matrix

PICTURE NUMBER: 2 PICTURES

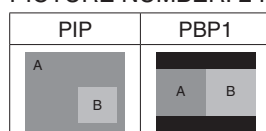

PICTURE NUMBER: 3 PICTURES

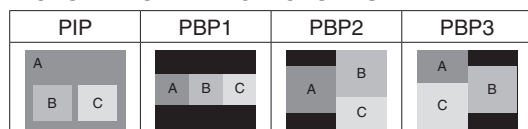

PICTURE NUMBER: 4 PICTURES

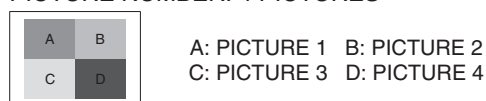

PICTURE NUMBER: 2 PICTURES

			Picture 2												
			HDMI1		HDMI2		HDMI3		MP	DisplayPort2	DisplayPort1	OPTION			
			Connector		HDMI IN1		HDMI IN2		HDMI IN3		–	DisplayPort IN2	DisplayPort IN1	Option Board slot (SLOT2 (DP))	Option Board slot (SLOT2 (DP+TMDS))
Picture 1	Connector	TERMINAL SETTINGS*1	MODE 1	MODE 2	MODE 1	MODE 2	MODE 1	MODE 2	MODE 1	–	–	–	2CH	MODE 1	
		HDMI1	HDMI IN1	MODE 1	Yes	No	Yes	No	Yes	No	Yes	Yes	Yes	Yes	*
		MODE 2	No	*	No	No	No	No	No	Yes	Yes	Yes	*	Yes	
	HDMI2	HDMI IN2	MODE 1	Yes	No	Yes	No	Yes	No	Yes	Yes	Yes	*	Yes	
		MODE 2	No	No	No	*	No	No	No	Yes	Yes	Yes	*	Yes	
	HDMI3	HDMI IN3	MODE 1	Yes	No	Yes	No	Yes	No	Yes	Yes	Yes	*	Yes	
		MODE 2	No	No	No	No	No	*	No	Yes	Yes	Yes	*	Yes	
	MP	–	MODE 1	Yes	No	Yes	No	Yes	No	Yes	Yes	Yes	*	Yes	
	DisplayPort2	DisplayPort IN2	–	Yes	*	Yes	*	Yes	*	Yes	Yes	Yes	*	Yes	
	DisplayPort1	DisplayPort IN1	–	Yes	*	Yes	*	Yes	*	Yes	Yes	No	No	Yes	
	OPTION	Option Board slot (SLOT2 (DP))	–	Yes	*	Yes	*	Yes	*	Yes	Yes	No	Yes	No	No
		Option Board slot (SLOT2 (DP+TMDS))	2CH	Yes	*	Yes	*	Yes	*	Yes	Yes	No	No	*	No
		Option Board slot (SLOT2 (TMDS))	MODE 1	Yes	*	Yes	*	Yes	*	Yes	Yes	Yes	No	No	Yes

\*: PBP1: Yes, PIP: No

\*1: SLOT2 CH SETTING for SLOT2 (DP+TMDS)

**PICTURE NUMBER: 3 PICTURES**

PIP/PBP1/PBP2 PICTURE 1: HDMI1 (MODE1)

			Picture 3												
			HDMI1		HDMI2		HDMI3		MP	DisplayPort2	DisplayPort1	OPTION			
			Connector	HDMI IN1		HDMI IN2		HDMI IN3		–	DisplayPort IN2	DisplayPort IN1	Option Board slot (SLOT2 (DP))	Option Board slot (SLOT2 (DP+TMDS))	Option Board slot (SLOT2 (TMDS))
Picture 2	Connector	TERMINAL SETTINGS*1	MODE 1	MODE 2	MODE 1	MODE 2	MODE 1	MODE 2	MODE 1	–	–	–	2CH	MODE 1	
Picture 1: HDMI1 (MODE1)	HDMI1	HDMI IN1	MODE 1	Yes	No	Yes	No	Yes	No	Yes	Yes	Yes	Yes	No	Yes
		HDMI IN1	MODE 2	No	No	No	No	No	No	No	No	No	No	No	No
	HDMI2	HDMI IN2	MODE 1	Yes	No	Yes	No	No	No	No	Yes	Yes	Yes	No	Yes
		HDMI IN2	MODE 2	No	No	No	No	No	No	No	No	No	No	No	No
	HDMI3	HDMI IN3	MODE 1	Yes	No	No	No	Yes	No	No	Yes	Yes	Yes	No	Yes
		HDMI IN3	MODE 2	No	No	No	No	No	No	No	No	No	No	No	No
	MP	–	MODE 1	Yes	No	No	No	No	No	Yes	Yes	Yes	No	Yes	
	DisplayPort2	DisplayPort IN2	–	Yes	No	Yes	No	Yes	No	Yes	Yes	Yes	Yes	No	Yes
	DisplayPort1	DisplayPort IN1	–	Yes	No	Yes	No	Yes	No	Yes	Yes	Yes	No	No	Yes
	OPTION	Option Board slot (SLOT2 (DP))	–	Yes	No	Yes	No	Yes	No	Yes	Yes	No	Yes	No	No
Option Board slot (SLOT2 (DP+TMDS))		2CH	No	No	No	No	No	No	No	No	No	No	No	No	
Option Board slot (SLOT2 (TMDS))		MODE 1	Yes	No	Yes	No	Yes	No	Yes	Yes	Yes	No	No	Yes	

\*1: SLOT2 CH SETTING for SLOT2 (DP+TMDS)

PIP/PBP2 PICTURE 1: HDMI1 (MODE2), HDMI2 (MODE2), HDMI3 (MODE2)

			Picture 3												
			HDMI1		HDMI2		HDMI3		MP	DisplayPort2	DisplayPort1	OPTION			
			Connector	HDMI IN1		HDMI IN2		HDMI IN3		–	DisplayPort IN2	DisplayPort IN1	Option Board slot (SLOT2 (DP))	Option Board slot (SLOT2 (DP+TMDS))	Option Board slot (SLOT2 (TMDS))
Picture 2	Connector	TERMINAL SETTINGS*1	MODE 1	MODE 2	MODE 1	MODE 2	MODE 1	MODE 2	MODE 1	–	–	–	2CH	MODE 1	
Picture 1: HDMI (MODE2)	HDMI1	HDMI IN1	MODE 1	No	No	No	No	No	No	No	No	No	No	No	No
		HDMI IN1	MODE 2	No	No	No	No	No	No	No	No	No	No	No	No
	HDMI2	HDMI IN2	MODE 1	No	No	No	No	No	No	No	No	No	No	No	No
		HDMI IN2	MODE 2	No	No	No	No	No	No	No	No	No	No	No	No
	HDMI3	HDMI IN3	MODE 1	No	No	No	No	No	No	No	No	No	No	No	No
		HDMI IN3	MODE 2	No	No	No	No	No	No	No	No	No	No	No	No
	MP	–	MODE 1	No	No	No	No	No	No	No	No	No	No	No	No
	DisplayPort2	DisplayPort IN2	–	No	No	No	No	No	No	No	Yes	Yes	Yes	No	Yes
	DisplayPort1	DisplayPort IN1	–	No	No	No	No	No	No	No	Yes	Yes	No	No	Yes
	OPTION	Option Board slot (SLOT2 (DP))	–	No	No	No	No	No	No	No	Yes	No	Yes	No	No
Option Board slot (SLOT2 (DP+TMDS))		2CH	No	No	No	No	No	No	No	No	No	No	No	No	
Option Board slot (SLOT2 (TMDS))		MODE 1	No	No	No	No	No	No	No	Yes	Yes	No	No	Yes	

\*1: SLOT2 CH SETTING for SLOT2 (DP+TMDS)

PIP/PBP1/PBP2 PICTURE 1: HDMI2 (MODE1)

			Picture 3												
			HDMI1		HDMI2		HDMI3		MP	DisplayPort2	DisplayPort1	OPTION			
			Connector	HDMI IN1		HDMI IN2		HDMI IN3		–	DisplayPort IN2	DisplayPort IN1	Option Board slot (SLOT2 (DP))	Option Board slot (SLOT2 (DP+TMDS))	Option Board slot (SLOT2 (TMDS))
Picture 2	Connector	TERMINAL SETTINGS*1	MODE 1	MODE 2	MODE 1	MODE 2	MODE 1	MODE 2	MODE 1	–	–	–	2CH	MODE 1	
Picture 1: HDMI2 (MODE1)	HDMI1	HDMI IN1	MODE 1	Yes	No	Yes	No	No	No	No	Yes	Yes	Yes	No	Yes
		HDMI IN1	MODE 2	No	No	No	No	No	No	No	No	No	No	No	No
	HDMI2	HDMI IN2	MODE 1	Yes	No	Yes	No	Yes	No	Yes	Yes	Yes	Yes	No	Yes
		HDMI IN2	MODE 2	No	No	No	No	No	No	No	No	No	No	No	No
	HDMI3	HDMI IN3	MODE 1	No	No	Yes	No	Yes	No	No	Yes	Yes	Yes	No	Yes
		HDMI IN3	MODE 2	No	No	No	No	No	No	No	No	No	No	No	No
	MP	–	MODE 1	No	No	Yes	No	No	No	Yes	Yes	Yes	No	Yes	
	DisplayPort2	DisplayPort IN2	–	Yes	No	Yes	No	Yes	No	Yes	Yes	Yes	Yes	No	Yes
	DisplayPort1	DisplayPort IN1	–	Yes	No	Yes	No	Yes	No	Yes	Yes	Yes	No	No	Yes
	OPTION	Option Board slot (SLOT2 (DP))	–	Yes	No	Yes	No	Yes	No	Yes	Yes	No	Yes	No	No
Option Board slot (SLOT2 (DP+TMDS))		2CH	No	No	No	No	No	No	No	No	No	No	No	No	
Option Board slot (SLOT2 (TMDS))		MODE 1	Yes	No	Yes	No	Yes	No	Yes	Yes	Yes	No	No	Yes	

\*1: SLOT2 CH SETTING for SLOT2 (DP+TMDS)

			Picture 3												
			HDMI1		HDMI2		HDMI3		MP	DisplayPort2	DisplayPort1	OPTION			
			Connector	HDMI IN1		HDMI IN2		HDMI IN3		–	DisplayPort IN2	DisplayPort IN1	Option Board slot (SLOT2 (DP))	Option Board slot (SLOT2 (DP+TMDS))	Option Board slot (SLOT2 (TMDS))
Picture 1: HDMI3 (MODE1)	Picture 2	Connector	TERMINAL SETTINGS*1	MODE 1	MODE 2	MODE 1	MODE 2	MODE 1	MODE 2	MODE 1	–	–	–	2CH	MODE 1
	HDMI1	HDMI IN1	MODE 1	Yes	No	No	No	Yes	No	No	No	Yes	Yes	Yes	No
MODE 2			No	No	No	No	No	No	No	No	No	No	No	No	No
HDMI2	HDMI IN2	MODE 1	No	No	Yes	No	Yes	No	No	No	Yes	Yes	Yes	No	Yes
		MODE 2	No	No	No	No	No	No	No	No	No	No	No	No	No
HDMI3	HDMI IN3	MODE 1	Yes	No	Yes	No	Yes	No	Yes	Yes	Yes	Yes	Yes	No	Yes
		MODE 2	No	No	No	No	No	No	No	No	No	No	No	No	No
MP	–	MODE 1	No	No	No	No	Yes	No	Yes	Yes	Yes	Yes	No	Yes	
DisplayPort2	DisplayPort IN2	–	Yes	No	Yes	No	Yes	No	Yes	Yes	Yes	Yes	No	Yes	
DisplayPort1	DisplayPort IN1	–	Yes	No	Yes	No	Yes	No	Yes	Yes	Yes	No	No	Yes	
OPTION	Option Board slot (SLOT2 (DP))	–	Yes	No	Yes	No	Yes	No	Yes	Yes	No	Yes	No	No	
	Option Board slot (SLOT2 (DP+TMDS))	2CH	No	No	No	No	No	No	No	No	No	No	No	No	
	Option Board slot (SLOT2 (TMDS))	MODE 1	Yes	No	Yes	No	Yes	No	Yes	Yes	Yes	No	No	Yes	

\*1: SLOT2 CH SETTING for SLOT2 (DP+TMDS)

PIP/PBP1/PBP2 PICTURE 1: MP

			Picture 3												
			HDMI1		HDMI2		HDMI3		MP	DisplayPort2	DisplayPort1	OPTION			
			Connector	HDMI IN1		HDMI IN2		HDMI IN3		–	DisplayPort IN2	DisplayPort IN1	Option Board slot (SLOT2 (DP))	Option Board slot (SLOT2 (DP+TMDS))	Option Board slot (SLOT2 (TMDS))
Picture 1: MP	Picture 2	Connector	TERMINAL SETTINGS*1	MODE 1	MODE 2	MODE 1	MODE 2	MODE 1	MODE 2	MODE 1	–	–	–	2CH	MODE 1
	HDMI1	HDMI IN1	MODE 1	Yes	No	No	No	No	No	No	Yes	Yes	Yes	Yes	No
MODE 2			No	No	No	No	No	No	No	No	No	No	No	No	No
HDMI2	HDMI IN2	MODE 1	No	No	Yes	No	No	No	Yes	Yes	Yes	Yes	Yes	No	Yes
		MODE 2	No	No	No	No	No	No	No	No	No	No	No	No	No
HDMI3	HDMI IN3	MODE 1	No	No	No	No	Yes	No	Yes	Yes	Yes	Yes	Yes	No	Yes
		MODE 2	No	No	No	No	No	No	No	No	No	No	No	No	No
MP	–	MODE 1	Yes	No	Yes	No	Yes	No	Yes	Yes	Yes	Yes	No	Yes	
DisplayPort2	DisplayPort IN2	–	Yes	No	Yes	No	Yes	No	Yes	Yes	Yes	Yes	No	Yes	
DisplayPort1	DisplayPort IN1	–	Yes	No	Yes	No	Yes	No	Yes	Yes	Yes	No	No	Yes	
OPTION	Option Board slot (SLOT2 (DP))	–	Yes	No	Yes	No	Yes	No	Yes	Yes	No	Yes	No	No	
	Option Board slot (SLOT2 (DP+TMDS))	2CH	No	No	No	No	No	No	No	No	No	No	No	No	
	Option Board slot (SLOT2 (TMDS))	MODE 1	Yes	No	Yes	No	Yes	No	Yes	Yes	Yes	No	No	Yes	

\*1: SLOT2 CH SETTING for SLOT2 (DP+TMDS)

PIP/PBP1/PBP2 PICTURE 1: DisplayPort2

			Picture 3												
			HDMI1		HDMI2		HDMI3		MP	DisplayPort2	DisplayPort1	OPTION			
			Connector	HDMI IN1		HDMI IN2		HDMI IN3		–	DisplayPort IN2	DisplayPort IN1	Option Board slot (SLOT2 (DP))	Option Board slot (SLOT2 (DP+TMDS))	Option Board slot (SLOT2 (TMDS))
Picture 1: DisplayPort2	Picture 2	Connector	TERMINAL SETTINGS*1	MODE 1	MODE 2	MODE 1	MODE 2	MODE 1	MODE 2	MODE 1	–	–	–	2CH	MODE 1
	HDMI1	HDMI IN1	MODE 1	Yes	No	Yes	No	Yes	No	Yes	Yes	Yes	Yes	Yes	No
MODE 2			No	No	No	No	No	No	No	No	No	No	No	No	No
HDMI2	HDMI IN2	MODE 1	Yes	No	Yes	No	Yes	No	Yes	Yes	Yes	Yes	Yes	No	Yes
		MODE 2	No	No	No	No	No	No	No	No	No	No	No	No	No
HDMI3	HDMI IN3	MODE 1	Yes	No	Yes	No	Yes	No	Yes	Yes	Yes	Yes	Yes	No	Yes
		MODE 2	No	No	No	No	No	No	No	No	No	No	No	No	No
MP	–	MODE 1	Yes	No	Yes	No	Yes	No	Yes	Yes	Yes	Yes	No	Yes	
DisplayPort2	DisplayPort IN2	–	Yes	No	Yes	No	Yes	No	Yes	Yes	Yes	Yes	No	Yes	
DisplayPort1	DisplayPort IN1	–	Yes	No	Yes	No	Yes	No	Yes	Yes	Yes	No	No	Yes	
OPTION	Option Board slot (SLOT2 (DP))	–	Yes	No	Yes	No	Yes	No	Yes	Yes	No	Yes	No	No	
	Option Board slot (SLOT2 (DP+TMDS))	2CH	No	No	No	No	No	No	No	No	No	No	No	No	
	Option Board slot (SLOT2 (TMDS))	MODE 1	Yes	No	Yes	No	Yes	No	Yes	Yes	Yes	No	No	Yes	

\*1: SLOT2 CH SETTING for SLOT2 (DP+TMDS)

PIP/PBP1/PBP2 PICTURE 1: DisplayPort1

			Picture 3											
			HDMI1		HDMI2		HDMI3		MP	DisplayPort2	DisplayPort1	OPTION		
			Connector	HDMI IN1	HDMI IN2	HDMI IN3	-			DisplayPort IN2	DisplayPort IN1	Option Board slot (SLOT2 (DP))	Option Board slot (SLOT2 (DP+TMDS))	Option Board slot (SLOT2 (TMDS))
Picture 2	Connector	TERMINAL SETTINGS*1	MODE 1	MODE 2	MODE 1	MODE 2	MODE 1	MODE 2	MODE 1	-	-	-	2CH	MODE 1
			HDMI1	HDMI IN1	MODE 1	Yes	No	Yes	No	Yes	No	Yes	Yes	Yes
		MODE 2	No	No	No	No	No	No	No	No	No	No	No	No
HDMI2	HDMI IN2	MODE 1	Yes	No	Yes	No	Yes	No	Yes	Yes	Yes	No	No	Yes
		MODE 2	No	No	No	No	No	No	No	No	No	No	No	No
HDMI3	HDMI IN3	MODE 1	Yes	No	Yes	No	Yes	No	Yes	Yes	Yes	No	No	Yes
		MODE 2	No	No	No	No	No	No	No	No	No	No	No	No
MP	-	MODE 1	Yes	No	Yes	No	Yes	No	Yes	Yes	Yes	No	No	Yes
DisplayPort2	DisplayPort IN2	-	Yes	No	Yes	No	Yes	No	Yes	Yes	Yes	No	No	Yes
DisplayPort1	DisplayPort IN1	-	Yes	No	Yes	No	Yes	No	Yes	Yes	Yes	No	No	Yes
OPTION	Option Board slot (SLOT2 (DP))	-	No	No	No	No	No	No	No	No	No	No	No	No
	Option Board slot (SLOT2 (DP+TMDS))	2CH	No	No	No	No	No	No	No	No	No	No	No	No
	Option Board slot (SLOT2 (TMDS))	MODE 1	Yes	No	Yes	No	Yes	No	Yes	Yes	Yes	No	No	Yes

\*1: SLOT2 CH SETTING for SLOT2 (DP+TMDS)

PIP/PBP1/PBP2 PICTURE 1: OPTION (DP)

			Picture 3											
			HDMI1		HDMI2		HDMI3		MP	DisplayPort2	DisplayPort1	OPTION		
			Connector	HDMI IN1	HDMI IN2	HDMI IN3	-			DisplayPort IN2	DisplayPort IN1	Option Board slot (SLOT2 (DP))	Option Board slot (SLOT2 (DP+TMDS))	Option Board slot (SLOT2 (TMDS))
Picture 2	Connector	TERMINAL SETTINGS*1	MODE 1	MODE 2	MODE 1	MODE 2	MODE 1	MODE 2	MODE 1	-	-	-	2CH	MODE 1
			HDMI1	HDMI IN1	MODE 1	Yes	No	Yes	No	Yes	No	Yes	Yes	No
		MODE 2	No	No	No	No	No	No	No	No	No	No	No	No
HDMI2	HDMI IN2	MODE 1	Yes	No	Yes	No	Yes	No	Yes	Yes	No	Yes	No	No
		MODE 2	No	No	No	No	No	No	No	No	No	No	No	No
HDMI3	HDMI IN3	MODE 1	Yes	No	Yes	No	Yes	No	Yes	Yes	No	Yes	No	No
		MODE 2	No	No	No	No	No	No	No	No	No	No	No	No
MP	-	MODE 1	Yes	No	Yes	No	Yes	No	Yes	Yes	No	Yes	No	No
DisplayPort2	DisplayPort IN2	-	Yes	No	Yes	No	Yes	No	Yes	Yes	No	Yes	No	No
DisplayPort1	DisplayPort IN1	-	No	No	No	No	No	No	No	No	No	No	No	No
OPTION	Option Board slot (SLOT2 (DP))	-	Yes	No	Yes	No	Yes	No	Yes	Yes	No	Yes	No	No
	Option Board slot (SLOT2 (DP+TMDS))	2CH	No	No	No	No	No	No	No	No	No	No	No	No
	Option Board slot (SLOT2 (TMDS))	MODE 1	No	No	No	No	No	No	No	No	No	No	No	No

\*1: SLOT2 CH SETTING for SLOT2 (DP+TMDS)

PIP/PBP2 PICTURE 1: OPTION (DP+TMDS)

			Picture 3											
			HDMI1		HDMI2		HDMI3		MP	DisplayPort2	DisplayPort1	OPTION		
			Connector	HDMI IN1	HDMI IN2	HDMI IN3	-			DisplayPort IN2	DisplayPort IN1	Option Board slot (SLOT2 (DP))	Option Board slot (SLOT2 (DP+TMDS))	Option Board slot (SLOT2 (TMDS))
Picture 2	Connector	TERMINAL SETTINGS*1	MODE 1	MODE 2	MODE 1	MODE 2	MODE 1	MODE 2	MODE 1	-	-	-	2CH	MODE 1
			HDMI1	HDMI IN1	MODE 1	Yes	No	Yes	No	Yes	No	Yes	Yes	No
		MODE 2	No	No	No	No	No	No	No	No	No	No	No	No
HDMI2	HDMI IN2	MODE 1	Yes	No	Yes	No	Yes	No	Yes	Yes	No	No	No	No
		MODE 2	No	No	No	No	No	No	No	No	No	No	No	No
HDMI3	HDMI IN3	MODE 1	Yes	No	Yes	No	Yes	No	Yes	Yes	No	No	No	No
		MODE 2	No	No	No	No	No	No	No	No	No	No	No	No
MP	-	MODE 1	Yes	No	Yes	No	Yes	No	Yes	Yes	No	No	No	No
DisplayPort2	DisplayPort IN2	-	Yes	No	Yes	No	Yes	No	Yes	Yes	No	No	No	No
DisplayPort1	DisplayPort IN1	-	No	No	No	No	No	No	No	No	No	No	No	No
OPTION	Option Board slot (SLOT2 (DP))	-	No	No	No	No	No	No	No	No	No	No	No	No
	Option Board slot (SLOT2 (DP+TMDS))	2CH	No	No	No	No	No	No	No	No	No	No	No	No
	Option Board slot (SLOT2 (TMDS))	MODE 1	No	No	No	No	No	No	No	No	No	No	No	No

\*1: SLOT2 CH SETTING for SLOT2 (DP+TMDS)

PIP/PBP2 PICTURE 1: OPTION (TMDS)

			Picture 3												
			HDMI1		HDMI2		HDMI3		MP	DisplayPort2	DisplayPort1	OPTION			
			Connector	HDMI IN1		HDMI IN2		HDMI IN3		–	DisplayPort IN2	DisplayPort IN1	Option Board slot (SLOT2 (DP))	Option Board slot (SLOT2 (DP+TMDS))	Option Board slot (SLOT2 (TMDS))
Picture 1: OPTION (TMDS)	Picture 2	Connector	TERMINAL SETTINGS*1	MODE 1	MODE 2	MODE 1	MODE 2	MODE 1	MODE 2	MODE 1	–	–	–	2CH	MODE 1
	HDMI1	HDMI IN1	MODE 1	Yes	No	Yes	No	Yes	No	Yes	Yes	Yes	Yes	No	No
MODE 2			No	No	No	No	No	No	No	No	No	Yes	No	No	No
HDMI2	HDMI IN2	MODE 1	Yes	No	Yes	No	Yes	No	Yes	Yes	Yes	Yes	No	No	Yes
		MODE 2	No	No	No	No	No	No	No	No	Yes	Yes	No	No	No
HDMI3	HDMI IN3	MODE 1	Yes	No	Yes	No	Yes	No	Yes	Yes	Yes	Yes	No	No	Yes
		MODE 2	No	No	No	No	No	No	No	No	No	Yes	No	No	No
MP	–	MODE 1	Yes	No	Yes	No	Yes	No	Yes	Yes	Yes	No	No	Yes	
DisplayPort2	DisplayPort IN2	–	Yes	No	Yes	No	Yes	No	Yes	Yes	Yes	No	No	Yes	
DisplayPort1	DisplayPort IN1	–	Yes	No	Yes	No	Yes	No	Yes	Yes	Yes	No	No	Yes	
OPTION	Option Board slot (SLOT2 (DP))	–	No	No	No	No	No	No	No	No	No	No	No	No	No
	Option Board slot (SLOT2 (DP+TMDS))	2CH	No	No	No	No	No	No	No	No	No	No	No	No	No
	Option Board slot (SLOT2 (TMDS))	MODE 1	Yes	No	Yes	No	Yes	No	Yes	Yes	Yes	No	No	Yes	

\*1: SLOT2 CH SETTING for SLOT2 (DP+TMDS)

PBP1 PICTURE1: OPTION (TMDS)

			Picture 3												
			HDMI1		HDMI2		HDMI3		MP	DisplayPort2	DisplayPort1	OPTION			
			Connector	HDMI IN1		HDMI IN2		HDMI IN3		–	DisplayPort IN2	DisplayPort IN1	Option Board slot (SLOT2 (DP))	Option Board slot (SLOT2 (DP+TMDS))	Option Board slot (SLOT2 (TMDS))
Picture 1: OPTION (TMDS)	Picture 2	Connector	TERMINAL SETTINGS*1	MODE 1	MODE 2	MODE 1	MODE 2	MODE 1	MODE 2	MODE 1	–	–	–	2CH	MODE 1
	HDMI1	HDMI IN1	MODE 1	Yes	No	Yes	No	Yes	No	Yes	Yes	Yes	Yes	No	No
MODE 2			No	No	No	No	No	No	No	No	No	No	No	No	No
HDMI2	HDMI IN2	MODE 1	Yes	No	Yes	No	Yes	No	Yes	Yes	Yes	Yes	No	No	Yes
		MODE 2	No	No	No	No	No	No	No	No	No	No	No	No	No
HDMI3	HDMI IN3	MODE 1	Yes	No	Yes	No	Yes	No	Yes	Yes	Yes	Yes	No	No	Yes
		MODE 2	No	No	No	No	No	No	No	No	No	No	No	No	No
MP	–	MODE 1	Yes	No	Yes	No	Yes	No	Yes	Yes	Yes	No	No	Yes	
DisplayPort2	DisplayPort IN2	–	Yes	No	Yes	No	Yes	No	Yes	Yes	Yes	No	No	Yes	
DisplayPort1	DisplayPort IN1	–	Yes	No	Yes	No	Yes	No	Yes	Yes	Yes	No	No	Yes	
OPTION	Option Board slot (SLOT2 (DP))	–	No	No	No	No	No	No	No	No	No	No	No	No	No
	Option Board slot (SLOT2 (DP+TMDS))	2CH	No	No	No	No	No	No	No	No	No	No	No	No	No
	Option Board slot (SLOT2 (TMDS))	MODE 1	Yes	No	Yes	No	Yes	No	Yes	Yes	Yes	No	No	Yes	

\*1: SLOT2 CH SETTING for SLOT2 (DP+TMDS)

PBP3 PICTURE 1: HDMI1 (MODE1)

			Picture 3												
			HDMI1		HDMI2		HDMI3		MP	DisplayPort2	DisplayPort1	OPTION			
			Connector	HDMI IN1		HDMI IN2		HDMI IN3		–	DisplayPort IN2	DisplayPort IN1	Option Board slot (SLOT2 (DP))	Option Board slot (SLOT2 (DP+TMDS))	Option Board slot (SLOT2 (TMDS))
Picture 1: HDMI1 (MODE1)	Picture 2	Connector	TERMINAL SETTINGS*1	MODE 1	MODE 2	MODE 1	MODE 2	MODE 1	MODE 2	MODE 1	–	–	–	2CH	MODE 1
	HDMI1	HDMI IN1	MODE 1	Yes	No	Yes	No	Yes	No	Yes	Yes	Yes	Yes	Yes	No
MODE 2			No	No	No	No	No	No	No	No	No	No	No	No	No
HDMI2	HDMI IN2	MODE 1	Yes	No	Yes	No	No	No	No	No	Yes	Yes	Yes	No	Yes
		MODE 2	No	No	No	No	No	No	No	No	No	No	No	No	No
HDMI3	HDMI IN3	MODE 1	Yes	No	No	No	Yes	No	No	No	Yes	Yes	Yes	No	Yes
		MODE 2	No	No	No	No	No	No	No	No	No	No	No	No	No
MP	–	MODE 1	Yes	No	No	No	No	No	Yes	Yes	Yes	Yes	No	Yes	
DisplayPort2	DisplayPort IN2	–	Yes	No	Yes	No	Yes	No	Yes	Yes	Yes	Yes	No	Yes	
DisplayPort1	DisplayPort IN1	–	Yes	No	Yes	No	Yes	No	Yes	Yes	Yes	No	No	Yes	
OPTION	Option Board slot (SLOT2 (DP))	–	Yes	No	Yes	No	Yes	No	Yes	Yes	No	Yes	No	No	
	Option Board slot (SLOT2 (DP+TMDS))	2CH	Yes	No	Yes	No	Yes	No	Yes	Yes	No	No	No	No	
	Option Board slot (SLOT2 (TMDS))	MODE 1	Yes	No	Yes	No	Yes	No	Yes	Yes	Yes	No	No	Yes	

\*1: SLOT2 CH SETTING for SLOT2 (DP+TMDS)

BPB3 PICTURE 1: HDMI2 (MODE1)

			Picture 3											
			HDMI1		HDMI2		HDMI3		MP	DisplayPort2	DisplayPort1	OPTION		
			Connector	HDMI IN1	HDMI IN2	HDMI IN3	-			DisplayPort IN2	DisplayPort IN1	Option Board slot (SLOT2 (DP))	Option Board slot (SLOT2 (DP+TMDS))	Option Board slot (SLOT2 (TMDS))
Picture 2	Connector	TERMINAL SETTINGS*1	MODE 1	MODE 2	MODE 1	MODE 2	MODE 1	MODE 2	MODE 1	-	-	-	2CH	MODE 1
			HDMI1	HDMI IN1	MODE 1	Yes	No	Yes	No	No	No	No	Yes	Yes
		MODE 2	No	No	No	No	No	No	No	No	No	No	No	No
HDMI2	HDMI IN2	MODE 1	Yes	No	Yes	No	Yes	No	Yes	Yes	Yes	Yes	No	Yes
		MODE 2	No	No	No	No	No	No	No	No	No	No	No	No
HDMI3	HDMI IN3	MODE 1	No	No	Yes	No	Yes	No	No	Yes	Yes	Yes	No	Yes
		MODE 2	No	No	No	No	No	No	No	No	No	No	No	No
MP	-	MODE 1	No	No	Yes	No	No	No	Yes	Yes	Yes	Yes	No	Yes
DisplayPort2	DisplayPort IN2	-	Yes	No	Yes	No	Yes	No	Yes	Yes	Yes	Yes	No	Yes
DisplayPort1	DisplayPort IN1	-	Yes	No	Yes	No	Yes	No	Yes	Yes	Yes	No	No	Yes
OPTION	Option Board slot (SLOT2 (DP))	-	Yes	No	Yes	No	Yes	No	Yes	Yes	No	Yes	No	No
	Option Board slot (SLOT2 (DP+TMDS))	2CH	Yes	No	Yes	No	Yes	No	Yes	Yes	No	No	No	No
	Option Board slot (SLOT2 (TMDS))	MODE 1	Yes	No	Yes	No	Yes	No	Yes	Yes	Yes	No	No	Yes

\*1: SLOT2 CH SETTING for SLOT2 (DP+TMDS)

BPB3 PICTURE 1: HDMI3 (MODE1)

			Picture 3											
			HDMI1		HDMI2		HDMI3		MP	DisplayPort2	DisplayPort1	OPTION		
			Connector	HDMI IN1	HDMI IN2	HDMI IN3	-			DisplayPort IN2	DisplayPort IN1	Option Board slot (SLOT2 (DP))	Option Board slot (SLOT2 (DP+TMDS))	Option Board slot (SLOT2 (TMDS))
Picture 2	Connector	TERMINAL SETTINGS*1	MODE 1	MODE 2	MODE 1	MODE 2	MODE 1	MODE 2	MODE 1	-	-	-	2CH	MODE 1
			HDMI1	HDMI IN1	MODE 1	Yes	No	No	No	Yes	No	No	Yes	Yes
		MODE 2	No	No	No	No	No	No	No	No	No	No	No	No
HDMI2	HDMI IN2	MODE 1	No	No	Yes	No	Yes	No	No	Yes	Yes	Yes	No	Yes
		MODE 2	No	No	No	No	No	No	No	No	No	No	No	No
HDMI3	HDMI IN3	MODE 1	Yes	No	Yes	No	Yes	No	Yes	Yes	Yes	Yes	No	Yes
		MODE 2	No	No	No	No	No	No	No	No	No	No	No	No
MP	-	MODE 1	No	No	No	No	Yes	No	Yes	Yes	Yes	Yes	No	Yes
DisplayPort2	DisplayPort IN2	-	Yes	No	Yes	No	Yes	No	Yes	Yes	Yes	Yes	No	Yes
DisplayPort1	DisplayPort IN1	-	Yes	No	Yes	No	Yes	No	Yes	Yes	Yes	No	No	Yes
OPTION	Option Board slot (SLOT2 (DP))	-	Yes	No	Yes	No	Yes	No	Yes	Yes	No	Yes	No	No
	Option Board slot (SLOT2 (DP+TMDS))	2CH	Yes	No	Yes	No	Yes	No	Yes	Yes	No	No	No	No
	Option Board slot (SLOT2 (TMDS))	MODE 1	Yes	No	Yes	No	Yes	No	Yes	Yes	Yes	No	No	Yes

\*1: SLOT2 CH SETTING for SLOT2 (DP+TMDS)

BPB3 PICTURE 1: MP

			Picture 3											
			HDMI1		HDMI2		HDMI3		MP	DisplayPort2	DisplayPort1	OPTION		
			Connector	HDMI IN1	HDMI IN2	HDMI IN3	-			DisplayPort IN2	DisplayPort IN1	Option Board slot (SLOT2 (DP))	Option Board slot (SLOT2 (DP+TMDS))	Option Board slot (SLOT2 (TMDS))
Picture 2	Connector	TERMINAL SETTINGS*1	MODE 1	MODE 2	MODE 1	MODE 2	MODE 1	MODE 2	MODE 1	-	-	-	2CH	MODE 1
			HDMI1	HDMI IN1	MODE 1	Yes	No	No	No	No	No	Yes	Yes	Yes
		MODE 2	No	No	No	No	No	No	No	No	No	No	No	No
HDMI2	HDMI IN2	MODE 1	No	No	Yes	No	No	No	Yes	Yes	Yes	Yes	No	Yes
		MODE 2	No	No	No	No	No	No	No	No	No	No	No	No
HDMI3	HDMI IN3	MODE 1	No	No	No	No	Yes	No	Yes	Yes	Yes	Yes	No	Yes
		MODE 2	No	No	No	No	No	No	No	No	No	No	No	No
MP	-	MODE 1	Yes	No	Yes	No	Yes	No	Yes	Yes	Yes	Yes	No	Yes
DisplayPort2	DisplayPort IN2	-	Yes	No	Yes	No	Yes	No	Yes	Yes	Yes	Yes	No	Yes
DisplayPort1	DisplayPort IN1	-	Yes	No	Yes	No	Yes	No	Yes	Yes	Yes	No	No	Yes
OPTION	Option Board slot (SLOT2 (DP))	-	Yes	No	Yes	No	Yes	No	Yes	Yes	No	Yes	No	No
	Option Board slot (SLOT2 (DP+TMDS))	2CH	Yes	No	Yes	No	Yes	No	Yes	Yes	No	No	No	No
	Option Board slot (SLOT2 (TMDS))	MODE 1	Yes	No	Yes	No	Yes	No	Yes	Yes	Yes	No	No	Yes

\*1: SLOT2 CH SETTING for SLOT2 (DP+TMDS)



			Picture 3											
			HDMI1		HDMI2		HDMI3		MP	DisplayPort2	DisplayPort1	OPTION		
			Connector	HDMI IN1	HDMI IN2	HDMI IN3	-			DisplayPort IN2	DisplayPort IN1	Option Board slot (SLOT2 (DP))	Option Board slot (SLOT2 (DP+TMDS))	Option Board slot (SLOT2 (TMDS))
Picture 2	Connector	TERMINAL SETTINGS*1	MODE 1	MODE 2	MODE 1	MODE 2	MODE 1	MODE 2	MODE 1	-	-	-	2CH	MODE 1
			HDMI1	HDMI IN1	MODE 1	Yes	No	Yes	No	Yes	No	Yes	Yes	Yes
		MODE 2	No	No	No	No	No	No	No	Yes	Yes	Yes	No	Yes
HDMI2	HDMI IN2	MODE 1	Yes	No	Yes	No	Yes	No	Yes	Yes	Yes	Yes	No	Yes
		MODE 2	No	No	No	No	No	No	No	Yes	Yes	Yes	No	Yes
HDMI3	HDMI IN3	MODE 1	Yes	No	Yes	No	Yes	No	Yes	Yes	Yes	Yes	No	Yes
		MODE 2	No	No	No	No	No	No	No	Yes	Yes	Yes	No	Yes
MP	-	MODE 1	Yes	No	Yes	No	Yes	No	Yes	Yes	Yes	Yes	No	Yes
DisplayPort2	DisplayPort IN2	-	Yes	No	Yes	No	Yes	No	Yes	Yes	Yes	Yes	No	Yes
DisplayPort1	DisplayPort IN1	-	Yes	No	Yes	No	Yes	No	Yes	Yes	Yes	No	No	Yes
OPTION	Option Board slot (SLOT2 (DP))	-	Yes	No	Yes	No	Yes	No	Yes	Yes	No	Yes	No	No
	Option Board slot (SLOT2 (DP+TMDS))	2CH	Yes	No	Yes	No	Yes	No	Yes	Yes	No	No	No	No
	Option Board slot (SLOT2 (TMDS))	MODE 1	Yes	No	Yes	No	Yes	No	Yes	Yes	Yes	No	No	Yes

\*1: SLOT2 CH SETTING for SLOT2 (DP+TMDS)

BPB3 PICTURE 1: DisplayPort1

			Picture 3											
			HDMI1		HDMI2		HDMI3		MP	DisplayPort2	DisplayPort1	OPTION		
			Connector	HDMI IN1	HDMI IN2	HDMI IN3	-			DisplayPort IN2	DisplayPort IN1	Option Board slot (SLOT2 (DP))	Option Board slot (SLOT2 (DP+TMDS))	Option Board slot (SLOT2 (TMDS))
Picture 2	Connector	TERMINAL SETTINGS*1	MODE 1	MODE 2	MODE 1	MODE 2	MODE 1	MODE 2	MODE 1	-	-	-	2CH	MODE 1
			HDMI1	HDMI IN1	MODE 1	Yes	No	Yes	No	Yes	No	Yes	Yes	Yes
		MODE 2	No	No	No	No	No	No	No	Yes	Yes	No	No	Yes
HDMI2	HDMI IN2	MODE 1	Yes	No	Yes	No	Yes	No	Yes	Yes	Yes	No	No	Yes
		MODE 2	No	No	No	No	No	No	No	Yes	Yes	No	No	Yes
HDMI3	HDMI IN3	MODE 1	Yes	No	Yes	No	Yes	No	Yes	Yes	Yes	No	No	Yes
		MODE 2	No	No	No	No	No	No	No	Yes	Yes	No	No	Yes
MP	-	MODE 1	Yes	No	Yes	No	Yes	No	Yes	Yes	Yes	No	No	Yes
DisplayPort2	DisplayPort IN2	-	Yes	No	Yes	No	Yes	No	Yes	Yes	Yes	No	No	Yes
DisplayPort1	DisplayPort IN1	-	Yes	No	Yes	No	Yes	No	Yes	Yes	Yes	No	No	Yes
OPTION	Option Board slot (SLOT2 (DP))	-	No	No	No	No	No	No	No	No	No	No	No	No
	Option Board slot (SLOT2 (DP+TMDS))	2CH	No	No	No	No	No	No	No	No	No	No	No	No
	Option Board slot (SLOT2 (TMDS))	MODE 1	Yes	No	Yes	No	Yes	No	Yes	Yes	Yes	No	No	Yes

\*1: SLOT2 CH SETTING for SLOT2 (DP+TMDS)

BPB3 PICTURE 1: OPTION (DP)

			Picture 3											
			HDMI1		HDMI2		HDMI3		MP	DisplayPort2	DisplayPort1	OPTION		
			Connector	HDMI IN1	HDMI IN2	HDMI IN3	-			DisplayPort IN2	DisplayPort IN1	Option Board slot (SLOT2 (DP))	Option Board slot (SLOT2 (DP+TMDS))	Option Board slot (SLOT2 (TMDS))
Picture 2	Connector	TERMINAL SETTINGS*1	MODE 1	MODE 2	MODE 1	MODE 2	MODE 1	MODE 2	MODE 1	-	-	-	2CH	MODE 1
			HDMI1	HDMI IN1	MODE 1	Yes	No	Yes	No	Yes	No	Yes	Yes	No
		MODE 2	No	No	No	No	No	No	No	Yes	No	Yes	No	No
HDMI2	HDMI IN2	MODE 1	Yes	No	Yes	No	Yes	No	Yes	Yes	No	Yes	No	No
		MODE 2	No	No	No	No	No	No	No	Yes	No	Yes	No	No
HDMI3	HDMI IN3	MODE 1	Yes	No	Yes	No	Yes	No	Yes	Yes	No	Yes	No	No
		MODE 2	No	No	No	No	No	No	No	Yes	No	Yes	No	No
MP	-	MODE 1	Yes	No	Yes	No	Yes	No	Yes	Yes	No	Yes	No	No
DisplayPort2	DisplayPort IN2	-	Yes	No	Yes	No	Yes	No	Yes	Yes	No	Yes	No	No
DisplayPort1	DisplayPort IN1	-	No	No	No	No	No	No	No	No	No	No	No	No
OPTION	Option Board slot (SLOT2 (DP))	-	Yes	No	Yes	No	Yes	No	Yes	Yes	No	Yes	No	No
	Option Board slot (SLOT2 (DP+TMDS))	2CH	No	No	No	No	No	No	No	No	No	No	No	No
	Option Board slot (SLOT2 (TMDS))	MODE 1	No	No	No	No	No	No	No	No	No	No	No	No

\*1: SLOT2 CH SETTING for SLOT2 (DP+TMDS)

PBP3 PICTURE 1: OPTION (TMDS)

			Picture 3												
			HDMI1		HDMI2		HDMI3		MP	DisplayPort2	DisplayPort1	OPTION			
			Connector	HDMI IN1		HDMI IN2		HDMI IN3		-	DisplayPort IN2	DisplayPort IN1	Option Board slot (SLOT2 (DP))	Option Board slot (SLOT2 (DP+TMDS))	Option Board slot (SLOT2 (TMDS))
Picture 2	Connector	TERMINAL SETTINGS*1	MODE 1	MODE 2	MODE 1	MODE 2	MODE 1	MODE 2	MODE 1	-	-	-	2CH	MODE 1	
			HDMI1	HDMI IN1	MODE 1	Yes	No	Yes	No	Yes	No	Yes	Yes	Yes	No
		MODE 2	No	No	No	No	No	No	No	Yes	Yes	No	No	Yes	
HDMI2	HDMI IN2	MODE 1	Yes	No	Yes	No	Yes	No	Yes	Yes	Yes	No	No	Yes	
		MODE 2	No	No	No	No	No	No	No	Yes	Yes	No	No	Yes	
HDMI3	HDMI IN3	MODE 1	Yes	No	Yes	No	Yes	No	Yes	Yes	Yes	No	No	Yes	
		MODE 2	No	No	No	No	No	No	No	Yes	Yes	No	No	Yes	
MP	-	MODE 1	Yes	No	Yes	No	Yes	No	Yes	Yes	Yes	No	No	Yes	
DisplayPort2	DisplayPort IN2	-	Yes	No	Yes	No	Yes	No	Yes	Yes	Yes	No	No	Yes	
DisplayPort1	DisplayPort IN1	-	Yes	No	Yes	No	Yes	No	Yes	Yes	Yes	No	No	Yes	
OPTION	Option Board slot (SLOT2 (DP))	-	No	No	No	No	No	No	No	No	No	No	No	No	
	Option Board slot (SLOT2 (DP+TMDS))	2CH	No	No	No	No	No	No	No	No	No	No	No	No	
	Option Board slot (SLOT2 (TMDS))	MODE 1	Yes	No	Yes	No	Yes	No	Yes	Yes	Yes	No	No	Yes	

\*1: SLOT2 CH SETTING for SLOT2 (DP+TMDS)

**PICTURE NUMBER: 4 PICTURES**

Only one input signal can be selected from within a group.

One of five groups is displayed on each screen. The same group can be selected more than once.

Group A	Group B	Group C	Group D	Group E
DisplayPort1 OPTION (DP)	DisplayPort2	HDMI1 HDMI2 HDMI3 MP	HDMI1 HDMI2 HDMI3 MP	OPTION (TMDS)

**NOTE:** HDMI1/HDMI2/HDMI3 TERMINAL SETTINGS is MODE1 only.

OPTION (DP) and OPTION (TMDS) cannot be selected at the same time (Can be choose either one).

## Video out

Main picture	DisplayPort1	DisplayPort2	HDMI1	HDMI2	HDMI3	OPTION		MP
Connector	DisplayPort IN1	DisplayPort IN2	HDMI IN1	HDMI IN2	HDMI IN3	Option Board slot (SLOT2 (DP))	Option Board slot (SLOT2 (HDMI))	-
DisplayPort	Yes	No	No	No	No	Yes	No	No

When the monitor outputs a signal from the DisplayPort out, please select input signal DisplayPort1 or OPTION.

This monitor's signal output function supports contents, which is protected by HDCP. In this case, up to 3 monitors are connectable.

When using an option, please set SLOT2 CH SETTING to 1CH then set SLOT2 CH SELECT to DisplayPort (See [page 45](#)).

**NOTE:** To output a signal from the DisplayPort out, some Slot2 type options are only available which have DisplayPort signal out.

# Features

---

**Reduced Footprint:** Provides the ideal solution for environments with superior image quality.

**SPECTRAVIEW ENGINE:** This system is designed for improvement the visual quality of the monitor. Each monitor is calibrated at the factory. By making automatic adjustments during operation of the monitor hardware in real time, optimal settings are configured without any user interaction.

**OmniColor:** Combines Six-axis color control and the sRGB standard. Six-axis color control permits color adjustments via six axes (R, G, B, C, M and Y) rather than through the three axes (R, G and B) previously available. The sRGB standard provides the monitor with a uniform color profile. This ensures that the colors displayed on the monitor are exactly the same as on the color printout (with sRGB supporting operating system and sRGB printer). This allows you to adjust the colors on your screen and customise the color accuracy of your monitor to a variety of standards.

**sRGB Color Control:** A color management standard which allows for color matching on computer monitors and other peripherals. The sRGB standard, which is based on a calibrated color space, allows for optimal color representation and backward compatibility with other common color standards.

**OSD (On-Screen-Display) Controls:** Allows you to quickly and easily adjust all elements of your screen image via easy to use on-screen menus.

**Plug and Play:** The Microsoft® solution with the Windows® operating system facilitates setup and installation by allowing the monitor to send its capabilities (such as screen size and resolutions supported) directly to your computer, automatically optimizing display performance.

**IPM (Intelligent Power Manager) System:** Provides innovative power-saving methods that allow the monitor to shift to a lower power consumption level when on but not in use, saving two-thirds of your monitor energy costs, reducing emissions and lowering the air conditioning costs of the workplace.

**FullScan Capability:** Allows you to use the entire screen area in most resolutions, significantly expanding image size.

**VESA Standard (FDMIv1) Mounting Interface:** Allows you to mount the monitor to any VESA standard (FDMIv1) third party mounting arm or bracket. NEC recommends using mounting equipment which complies with TÜV-GS (Germany) and/or UL1678 standard (North America).

**ZOOM:** Expands/reduces the image size in horizontal and vertical direction.

**Self-diagnosis:** If an internal error should occur, a failure state will be indicated.

**USB hub:** Allows the connection of digital cameras, scanners, keyboards and more.

**HDCP (High-bandwidth Digital Content Protection):** HDCP is a system for preventing illegal copying of video data sent over a digital signal. If you are unable to view material via the digital input, this does not necessarily mean that the monitor is not functioning properly. With the implementation of HDCP, there may be cases in which certain content is protected by HDCP and might not be displayed due to the decision/intention of the HDCP community (Digital Content Protection, LLC).

**Option Board slot:** You can use an Option Board. Please contact your supplier for detailed information.

**DICOM Sim.:** A DICOM gamma curve emulation which is stored inside the monitor as fixed Look Up Table values. When selecting DICOM Sim., these values are loaded into the active Look Up Table of the monitor to create a DICOM like gamma correction curve. Suitable for DICOM image viewing in clinical review. Must not be used for DICOM image viewing in diagnostics.

**TILE MATRIX, TILE COMP:** Shows one image over multiple screens with accuracy while compensating for bezel width.

# Troubleshooting

---

## No picture

- The signal cable should be completely connected to the display card/computer.
- The display card should be completely seated in its slot.
- Check the main Power Switch, it should be in the ON position.
- Power Switches for the monitor and computer should be in the ON position.
- Make sure that a supported resolution has been selected on the display card or system being used. If in doubt, please refer to the user's manual of the display card or system to change the resolution.
- Check the monitor and your display card with respect to compatibility and recommended signal timings.
- Check the signal cable connector for bent or pushed-in pins.
- The monitor automatically goes into standby at the preset time period after the video signal was lost. Press the power on button on the remote control or press the power button on the monitor.
- If you unplug the signal cable when starting the computer, images may not be displayed. Turn off the monitor and the computer and then connect the signal cable and turn on the computer and the monitor.
- Check the OPTION POWER setting when you use Option Board accessories.

## Power Button does not respond

- Unplug the power cord of the monitor from the AC outlet to turn off and reset the monitor.
- Check the main Power Switch on the monitor.

## Image persistence

- Please be aware that LCD Technology may experience a phenomenon known as Image Persistence. Image Persistence occurs when a residual or "ghost" image of a previous image remains visible on the screen. Unlike CRT monitors, the image persistence of LCD monitors is not permanent, but single still image being displayed for a long period of time should be avoided. To alleviate image persistence, put the monitor into standby via remote control or turn the monitor's main power off for as long as the previous image was displayed. For example, if an image was on the monitor for one hour and a residual image remains, the monitor should be in standby or main power off for one hour to erase the image.

**NOTE:** As with all personal display devices, NEC DISPLAY SOLUTIONS recommends displaying moving images, using a moving screen saver, or changing still images at regular intervals whenever the screen is idle, or turning it into standby or main power off of the monitor when not in use.

## The image is blinking

- If you use a signal repeater or distributor or a long cable, this may cause image roughness or blink for a moment. In this case please connect the cable to the monitor directly without using a repeater or a distributor, or replace the cable with a higher quality cable. Using a twisted pair extender may cause image roughness depending on the environment where the monitor is in or the cable you are using. For further information please ask your supplier.
- Some HDMI cables may not show a correct image. If input resolution is 1920 x 2160, 3840 x 2160 or 4096 x 2160, please use an HDMI cable which is approved to support 4K resolution.

## The image is unstable, unfocused or swimming is apparent

- The signal cable should be completely attached to the computer.
- Use the OSD Image Adjust controls to focus and adjust the display by increasing or decreasing the fine adjustment.  
When the display mode is changed, the OSD Image Adjust settings may need to be re-adjusted.
- Check the monitor and your display card with respect to compatibility and recommended signal timings.
- If text looks garbled, change the video mode to non-interlaced and use a 60 Hz refresh rate.
- The image may be distorted when turning the power on, changing the settings or changing the settings of a connected device. It is not a failure of this product.

## LED on the monitor is not lit (no blue or red color can be seen)

- The power Switch should be in the ON position and the power cord should be connected.
- Check the main Power Switch, it should be in the ON position.
- Make certain the computer is not in a power-saving mode (touch the keyboard or move the mouse).
- Check in the OSD that the power indicator option is set to ON.

## LED colors, except for blue, are blinking or glowing

- A certain failure might have occurred, please contact your supplier.
- If the monitor is powered off by the internal temperature being higher than the normal operating temperature, the LED will blink green or amber or red for six times. Power on the monitor again after confirming the internal temperature has been reduced to normal operation temperature.
- The monitor could be in standby. Press the power on button on the remote control or press the power button on the monitor.

## The image is not properly reproduced

- Use the OSD Image Adjust controls to increase or decrease the coarse adjustment.
- Make sure that a supported resolution has been selected on the display card or system being used. If in doubt, please refer to the user's manual of the display card or system to change the resolution.

**Selected resolution is not displayed properly**

- Use OSD Display Mode to enter Information menu and confirm that the appropriate resolution has been selected. If not, select corresponding option.

**No Sound**

- Check to see if the audio cable is properly connected.
- Check to see if MUTE is activated. Use the remote control to enable or disable the Mute function.
- Check to see if VOLUME is set to a minimum.
- Check to see if the computer supports an audio signal through DisplayPort.  
If unsure, contact your supplier.
- When LINE OUT is not functioning, check to see if SURROUND is ON.
- Check the Internal/External speaker switch.
- If HDMI CEC audio device is not connected, please set "AUDIO RECEIVER" to OFF.

**The Remote Control is not functioning**

- Check the batteries status of the Remote Control.
- Check if the batteries are inserted correctly.
- Check if the Remote Control is pointing at the remote control sensor of the monitor.
- Check the status of IR LOCK SETTINGS.
- The remote control system may not function when direct sunlight or strong illumination strikes the remote control sensor of the monitor, or when there is an object in the path.

**The SCHEDULE/OFF TIMER function is not working properly**

- The "SCHEDULE" function will be disabled when the "OFF TIMER" is set.
- If the "OFF TIMER" function is enabled and the power to the LCD monitor is turned off when the power supply is interrupted unexpectedly, then the "OFF TIMER" will be reset.

**Snowy Picture, Poor Sound in TV**

- Check antenna/cable connection. Use new cable if necessary.

**The USB Hub does not operate**

- Check to make sure that the USB cable is properly connected. Refer to your USB device user's manual.
- Check if the USB upstream port on the monitor is connected to the USB downstream port on the computer. Please make sure the computer is ON or USB POWER is ON.
- Check the format if this device cannot recognize the connected USB memory.
- Disconnect one upstream USB cable when using 2 upstream connections.

**Interference in TV**

- Check components for shielding, move away from monitor if necessary.

**USB or RS-232C or LAN control is not available**

- Check RS-232C (reverse type) or the LAN cable. A category 5 or higher LAN cable is required for connection.
- Check USB cable connected to USB2 port. Check the EXTERNAL CONTROL is set to ENABLE then PC SOURCE is set to EXTERNAL PC.

**The monitor goes into standby automatically**

- Please check "OFF TIMER" setting.
- Set the "CEC" function to OFF.

**Media player function does not recognize the USB storage device**

- Please check a USB storage device is connected to the USB MP.

**MicroSD card does not work**

- Check to make sure the microSD card is properly connected.
- Check the microSD memory card format.

Either light vertical or horizontal stripes may appear, depending on the specific image pattern. This is not a product fault or degradation.

# Specifications - P654Q

## Product Specifications

LCD Module		Pixel Pitch:	65"/163.9 cm diagonal
		Resolution:	0.372 mm
		Color:	3840 x 2160
		Brightness:	Over 1073 million colors (depending on display card used)
		Contrast Ratio:	700 cd/m <sup>2</sup> (Max.) @25°C
		Viewing Angle:	4000:1
			89° (typ) @ CR>10
Frequency		Horizontal:	31.5 kHz - 91.1 kHz
		Vertical:	24.0 - 85.0 Hz (Digital Input)
Pixel Clock			Digital: 25.0 MHz - 540.0 MHz (DisplayPort), 25.0 MHz - 600.0 MHz (HDMI)
Viewable Size			1428.48 x 803.55 mm
Input Signal			
DisplayPort	DisplayPort Connector	Digital RGB	DisplayPort V1.2 (HDCP 1.3) VGA60, SVGA60, XGA60, WXGA60, SXGA60, UXGA60, WUXGA60, 1920x1080 (60 Hz), 1080p, 1080i, 720p@50Hz/60Hz, 576p@50Hz, 480p@60Hz, 3840x2160 (24Hz/30Hz/60Hz (DisplayPort1.2))
HDMI	HDMI Connector	Digital YUV Digital RGB	HDMI (HDCP 1.4/2.2) VGA60, SVGA60, XGA60, WXGA60, SXGA60, UXGA60, WUXGA60, 1920x1080 (60 Hz), 1080p, 1080i, 720p@50Hz/60Hz, 576p@50Hz, 480p@60Hz, 576i@50Hz, 480i@60Hz, 3840x2160 (30Hz/24Hz/25Hz/60Hz (MODE2)), 4096x2160 (30Hz/24Hz/25Hz/60Hz (MODE2))*1,*2
Output Signal			
DisplayPort	DisplayPort Connector	Digital RGB	DisplayPort V1.2 (HDCP 1.3)
AUDIO			
AUDIO Input	Stereo Mini Jack	Analog Audio	Stereo L/R 0.5 Vrms
	HDMI Connector	Digital Audio	PCM 32, 44.1, 48 KHz (16/20/24bit)
	DisplayPort Connector	Digital Audio	PCM 32, 44.1, 48 KHz (16/20/24bit)
AUDIO Output	Stereo Mini Jack	Analog Audio	Stereo L/R 0.5 Vrms
Speaker Output			External Speaker Jack 15 W + 15 W (8 ohm) Internal Speaker 10 W + 10 W (Stereo)
Control		RS-232C In:	9 Pin D-sub
		LAN:	RJ-45 10 BASE-T/100 BASE-TX x 2
		Remote IN:	Stereo Mini Jack 3.5 mm Ø
SD card Hub			Port: microSD card. Up to 32GB microSDHC is supported.
USB Hub		USB1:	USB 2.0 Downstream port
		USB2:	USB 2.0 Upstream port
		USB CM1 (2A):	Power supply port, 5V/2A (max.)
		USB CM2:	USB service port for maintenance
		USB MP:	Media Player/Firmware update port
Power Supply			4.8 - 2.0 A @ 100-240V AC, 50/60Hz
Power Consumption		Normal operation:	Approx. 230 W
Operational Environment		Temperature:	0 - 40°C / 32 - 104°F
		Humidity:	20 - 80% (without condensation)
		Altitude:	0 - 3000 m (Brightness may decrease with altitude)
Storage Environment		Temperature:	-20 - 60°C / -4 - 140°F
		Humidity:	10 - 90% (without condensation) / 90% - 3.5% x (Temp - 40°C) regarding over 40°C
Dimension*3			1457.1 (W) x 832.1 (H) x 79.4 (D) mm/57.37 (W) x 32.76 (H) x 3.13 (D) inches
Weight			40.6 kg (89.5 lbs)
VESA compatible mounting interface			400 mm x 400 mm (M8, 4 Holes)
Power Management			VESA DPM
Power supply for Slot 2 type OPTION			16V/4.7 A

**NOTE:** Technical specifications are subject to change without notice.

\*1: Compressed image.

\*2: Reproduced text may look blurred.

\*3: Measurements are of the monitor only and do not include removable parts that protrude.

# Specifications - P754Q

## Product Specifications

LCD Module		Pixel Pitch:	75"/189.27 cm diagonal
		Resolution:	0.430 mm
		Color:	3840 x 2160
		Brightness:	Over 1073 million colors (depending on display card used)
		Contrast Ratio:	650 cd/m <sup>2</sup> (Max.) @25°C
		Viewing Angle:	1200:1
			89° (typ) @ CR>10
Frequency		Horizontal:	31.5 kHz - 91.1 kHz
		Vertical:	24.0 - 85.0 Hz (Digital Input)
Pixel Clock			Digital: 25.0 MHz - 540.0 MHz (DisplayPort), 25.0 MHz - 600.0 MHz (HDMI)
Viewable Size			1649.66 x 927.94 mm
Input Signal			
DisplayPort	DisplayPort Connector	Digital RGB	DisplayPort V1.2 (HDCP 1.3) VGA60, SVGA60, XGA60, WXGA60, SXGA60, UXGA60, WUXGA60, 1920x1080 (60 Hz), 1080p, 1080i, 720p@50Hz/60Hz, 576p@50Hz, 480p@60Hz, 3840x2160 (24Hz/30Hz/60Hz (DisplayPort1.2))
HDMI	HDMI Connector	Digital YUV Digital RGB	HDMI (HDCP 1.4/2.2) VGA60, SVGA60, XGA60, WXGA60, SXGA60, UXGA60, WUXGA60, 1920x1080 (60 Hz), 1080p, 1080i, 720p@50Hz/60Hz, 576p@50Hz, 480p@60Hz, 576i@50Hz, 480i@60Hz, 3840x2160 (30Hz/24Hz/25Hz/60Hz (MODE2)), 4096x2160 (30Hz/24Hz/25Hz/60Hz (MODE2))*1,*2
Output Signal			
DisplayPort	DisplayPort Connector	Digital RGB	DisplayPort V1.2 (HDCP 1.3)
AUDIO			
AUDIO Input	Stereo Mini Jack	Analog Audio	Stereo L/R 0.5 Vrms
	HDMI Connector	Digital Audio	PCM 32, 44.1, 48 KHz (16/20/24bit)
	DisplayPort Connector	Digital Audio	PCM 32, 44.1, 48 KHz (16/20/24bit)
AUDIO Output	Stereo Mini Jack	Analog Audio	Stereo L/R 0.5 Vrms
Speaker Output			External Speaker Jack 15 W + 15 W (8 ohm) Internal Speaker 10 W + 10 W (Stereo)
Control		RS-232C In:	9 Pin D-sub
		LAN:	RJ-45 10 BASE-T/100 BASE-TX x 2
		Remote IN:	Stereo Mini Jack 3.5 mm Ø
SD card Hub			Port: microSD card. Up to 32GB microSDHC is supported.
USB Hub		USB1:	USB 2.0 Downstream port
		USB2:	USB 2.0 Upstream port
		USB CM1 (2A):	Power supply port, 5V/2A (max.)
		USB CM2:	USB service port for maintenance
		USB MP:	Media Player/Firmware update port
Power Supply			4.4 - 1.9 A @ 100-240V AC, 50/60Hz
Power Consumption		Normal operation:	Approx. 195 W
Operational Environment		Temperature:	0 - 40°C / 32 - 104°F
		Humidity:	20 - 80% (without condensation)
		Altitude:	0 - 3000 m (Brightness may decrease with altitude)
Storage Environment		Temperature:	-20 - 60°C / -4 - 140°F
		Humidity:	10 - 90% (without condensation) / 90% - 3.5% x (Temp - 40°C) regarding over 40°C
Dimension*3			1681.2 (W) x 959.6 (H) x 71.1 (D) mm/66.2 (W) x 37.8 (H) x 2.8 (D) inches
Weight			52.6 kg (116.0 lbs)
VESA compatible mounting interface			400 mm x 400 mm (M8, 4 Holes)
Power Management			VESA DPM
Power supply for Slot 2 type OPTION			16V/4.7 A

**NOTE:** Technical specifications are subject to change without notice.

\*1: Compressed image.

\*2: Reproduced text may look blurred.

\*3: Measurements are of the monitor only and do not include removable parts that protrude.



# Manufacturer's Recycling and Energy Information

---

NEC DISPLAY SOLUTIONS is strongly committed to environmental protection and sees recycling as one of the company's top priorities in trying to minimize the burden placed on the environment. We are engaged in developing environmentally-friendly products, and always strive to help define and comply with the latest independent standards from agencies such as ISO (International Organisation for Standardization) and TCO (Swedish Trades Union).

## Disposing of your old NEC product

The aim of recycling is to gain an environmental benefit by means of re-use, upgrading, reconditioning or reclamation of material. Dedicated recycling sites ensure that environmentally harmful components are properly handled and securely disposed. To ensure the best recycling of our products, **NEC DISPLAY SOLUTIONS offers a variety of recycling procedures** and gives advice on how to handle the product in an environmentally sensitive way, once it has reached the end of its life.

All required information concerning the disposal of the product and country-specific information on recycling facilities can be found on our following websites:

<https://www.nec-display-solutions.com/p/greenvision/en/greenvision.xhtml> (in Europe),

<https://www.nec-display.com> (in Japan) or

<https://www.necdisplay.com> (in USA).

## Energy Saving

This monitor features an advanced energy saving capability. When a Display Power Management signal is sent to the monitor, the Energy Saving mode is activated. The monitor enters a single Energy Saving mode.

For additional information visit:

<https://www.necdisplay.com/> (in USA)

<https://www.nec-display-solutions.com/> (in Europe)

<https://www.nec-display.com/global/index.html> (Global)

For ErP requirement/For ErP (Network standby) requirement:

Except for the conditions below: The monitor is using an Option Board.

INPUT DETECT is set to a setting except for NONE.

USB POWER is set to ON.

DisplayPort in the TERMINAL SETTINGS is set to MST.

Power consumption (Glowing amber): 2.0 W or less (with 1 port connection)/3.0 W or less (with all ports connection).

Time for power management function: 10 sec. (Default setting)

Power consumption (Blinking amber): 0.5 W or less.

Time for power management function: 3 min. (Default setting)

(Except for a condition that the monitor has plural signal inputs.)

## WEEE Mark (European Directive 2012/19/EU and amendments)



### Disposing of your used product: In the European Union

EU-wide legislation as implemented in each Member State requires that used electrical and electronic products carrying the mark (left) must be disposed of separately from normal household waste. This includes monitors and electrical accessories, such as signal cables or power cords. When you dispose of such products, please follow the guidance of your local authority or ask the shop where you purchased the product, or if applicable, follow applicable legislation or agreement you may have. The mark on electrical and electronic products may only apply to the current European Union Member States.

### Outside the European Union

If you wish to dispose of used electrical and electronic products outside the European Union, please contact your local authority and ask for the correct method of disposal.



**For EU:** The crossed-out wheeled bin implies that used batteries should not be put to the general household waste! There is a separate collection system for used batteries, to allow proper treatment and recycling in accordance with legislation.

**According to EU directive 2006/66/EC and amendments, the battery can't be disposed improperly. The battery shall be separated to collect by local service.**

---

---

## **[Notice] About the MPEG-4 AVC, MPEG-4 Visual license included in this product**

---

---

### **1. MPEG-4 AVC**

THIS PRODUCT IS LICENSED UNDER THE AVC PATENT PORTFOLIO LICENSE FOR THE PERSONAL USE OF A CONSUMER OR OTHER USES IN WHICH IT DOES NOT RECEIVE REMUNERATION TO (i) ENCODE VIDEO IN COMPLIANCE WITH THE AVC STANDARD ("AVC VIDEO") AND/OR (ii) DECODE AVC VIDEO THAT WAS ENCODED BY A CONSUMER ENGAGED IN A PERSONAL ACTIVITY AND/OR WAS OBTAINED FROM A VIDEO PROVIDER LICENSED TO PROVIDE AVC VIDEO. NO LICENSE IS GRANTED OR SHALL BE IMPLIED FOR ANY OTHER USE. ADDITIONAL INFORMATION MAY BE OBTAINED FROM MPEG LA, L.L.C. SEE [HTTP://WWW.MPEGLA.COM](http://www.mpegla.com)

### **2. MPEG-4 Visual**

THIS PRODUCT IS LICENSED UNDER THE MPEG-4 VISUAL PATENT PORTFOLIO LICENSE FOR THE PERSONAL AND NON-COMMERCIAL USE OF A CONSUMER FOR (i) ENCODING VIDEO IN COMPLIANCE WITH THE MPEG-4 VISUAL STANDARD ("MPEG-4 VIDEO") AND/OR (ii) DECODING MPEG-4 VIDEO THAT WAS ENCODED BY A CONSUMER ENGAGED IN A PERSONAL AND NONCOMMERCIAL ACTIVITY AND/OR WAS OBTAINED FROM A VIDEO PROVIDER LICENSED BY MPEG LA TO PROVIDE MPEG-4 VIDEO. NO LICENSE IS GRANTED OR SHALL BE IMPLIED FOR ANY OTHER USE. ADDITIONAL INFORMATION INCLUDING THAT RELATING TO PROMOTIONAL, INTERNAL AND COMMERCIAL USES AND LICENSING MAY BE OBTAINED FROM MPEG LA, LLC. SEE [HTTP://WWW.MPEGLA.COM](http://www.mpegla.com).