

Pioneer

SE-MJ553BT

WIRELESS STEREO HEADPHONES

 **Bluetooth**[®]

U.S.A. Only
États-Unis seulement

BC

Operating Instructions



Thank you for buying this Pioneer product. Please read through these operating instructions so you will know how to operate your model properly.

Main Features

Wireless music enjoyment

- Wireless music enjoyment on *Bluetooth* devices (smart phones and other cell phones, digital music players, etc.) *1
For operating details consult the user's manual for the device to be connected.
- Allows control of play, stop, forward and reverse selection. *2

Hands-free communication

- Hands-free communication is possible even with the *Bluetooth* telephone placed in your bag or briefcase. *3

*1 The corresponding *Bluetooth* device must support the A2DP profile.

*2 The corresponding *Bluetooth* device must support the AVRCP profile. Also, remote control operation cannot be guaranteed for all devices.

*3 The corresponding *Bluetooth* device must support the HSP or HFP profile.

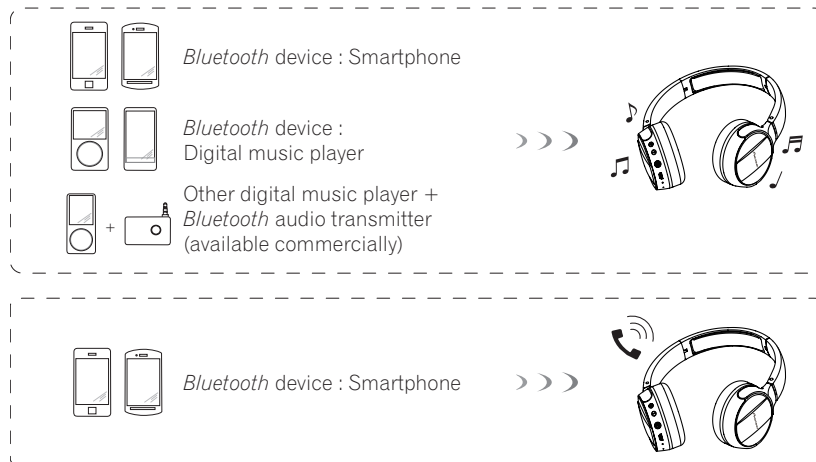

Glossary

A2DP : High-quality musical contents transmission profile

HSP : Communication/cell-phone operation profile

HFP : Hands-free communication/cell-phone operation profile

AVRCP : AV components remote control profile

1. Set Contents

Confirm the presence of all parts and components before use.

1 : Headphones



2 : Micro-USB cable



3 : Warranty (Europe / U.S.A. and Canada / Japan)

4 : Quick Start Guide

5 : Safety Guide

2. Names of Parts

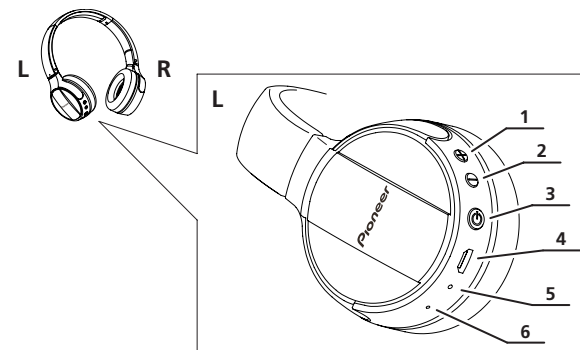

1 : (+) button

2 : (-) button

3 : (P) button

4 : Micro-USB port

5 : LED indicator

6 : Microphone

3. Charging the batteries

The unit's battery must be recharged before use.
The accessory micro-USB cable must be used for recharging the unit's battery.

Connect the appropriate connector on the accessory micro-USB cable to the micro-USB port on the headphones, and the USB plug on the other end to a USB port on a computer.

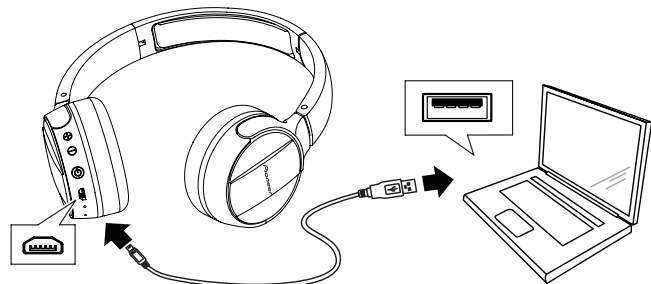

- When recharging begins, the LED indicator on the headphones will light red.
- If recharging is performed with the unit's power turned ON, the power will automatically turn OFF. The unit cannot be used during recharging.
- Full recharging requires about 4 hours; when recharging is completed, the LED indicator will turn off.
- With a full battery charge, the maximum continuous usable time is about 15 hours.
- When the rechargeable battery's power become low, a beeping sound can be heard from the unit once every 3 minutes, and the LED indicator flashes red. In this case, recharge the battery before using the unit.

Note

- Battery recharging time and usable battery time may vary depending on ambient temperature and frequency of use.
- Do not place metal objects near the headphones' charging contacts, since dangerous electrical shorts or abnormal heating may result.

Notes on battery charging

- This device cannot be used during charging.
- Battery performance is influenced by the surrounding temperature. Charge the supplied rechargeable batteries within a temperature range of 10 to 35 degrees celcius.
- Do not overcharge batteries. In order to protect batteries, do not repeatedly charge the batteries that are already fully charged.

- Batteries become slightly warm when charging. This is not a malfunction.
- Please use the accessory micro-USB cable for recharging; using other cables may result in malfunction.
- Recharging may not be possible if computer is in power-saving mode.
- Always confirm the proper shape and orientation of the micro-USB cable plugs before attempting to connect to the headphones and computer.
- Do not use micro-USB cables when tightly twisted or bundled, since fire or electric shock might result.
- If you do not plan to use this product for an extended period, avoid storing it in a hot or humid location (such as in a vehicle or in direct sunlight). Storage in such locations may degrade the rechargeable battery and shorten the usable time.
- If you do not plan to use this product for an extended period, charge it for approximately one hour before storing it. Long periods of storage with a full battery or without any charge may degrade the rechargeable battery and shorten the usable time.

4. Pairing

Pairing must be performed before the headphones can be used to listen to music or communicate using a *Bluetooth* device.
For further details regarding the pairing procedure, consult the user's manual for your *Bluetooth* device.

(1) While the power of the unit is off, hold down the (⏻) button until the unit enters pairing mode.

- The pairing mode is confirmed by the LED indicator's alternately flashing blue and red.

Release the (⏻) button after confirming that the LED indicator is alternately lighting blue and red.

- When in the pairing mode, if pairing is not completed within about 5 minutes, the power will automatically turn off.

(2) Turn on the power to the *Bluetooth* device you wish to pair with, and begin pairing; search for this unit (wireless headphones) from the paired *Bluetooth* device.

- Set the *Bluetooth* device close (within one meter) to the wireless headphones.
- These wireless headphones will appear in the *Bluetooth* device's display as "SE-MJ553BT".

(3) Confirm that pairing has been successfully completed with the *Bluetooth* device.

- Look at the display for the *Bluetooth*-enabled device and select "SE-MJ553BT".
- When the LED lamp is flashing in blue slowly about once every 3 seconds, pairing is complete. When it is flashing quickly about once every second, pairing is not complete.
- The PIN code for these wireless headphones has been factory set at "0000".
Input this code if requested by the *Bluetooth* device.

Connect to the *Bluetooth* device

- Confirm that the power to the wireless headphones is ON before connecting to the *Bluetooth* device.
- Depending on the device, connection between the wireless headphones and *Bluetooth* device may be effected automatically after pairing.

Disconnecting from the *Bluetooth* device

- Hold down the (⏻) button until the flashing LED lamp turns off and the power of the device turns off.

Note

- Depending on the device connected, the A2DP profile may need to be designated when playing music, and the HFP or HSP profiles for hands-free communication.
- For details regarding operating and setting methods, consult the user's manual for the *Bluetooth* device.
- When a connection with the device becomes no longer possible, perform pairing again.
- These wireless headphones can record pairing information for up to 8 *Bluetooth* devices. If pairing is performed for a ninth device, the information for the first paired device will be overwritten and lost. If you wish to reconnect to that device on a subsequent occasions, it will be necessary to repeat pairing with that device.
- Whenever using a device with which pairing has been performed, first turn on the power to the wireless headphones, then perform the connection operation for the paired *Bluetooth* device.

5. Enjoying music

To use the wireless headphones to listen to music from a *Bluetooth* device, you must first perform pairing with the *Bluetooth* device using the A2DP audio profile. For details on how to perform pairing, see P.4.

(1) With power to the wireless headphones' turned off, hold the (⏻) button depressed for about three seconds.

The headphones' power will turn on and the LED indicator will flash blue.

(2) Turn on the *Bluetooth* function on the device you wish to connect to.

When pairing is completed, the wireless headphones will automatically connect to the *Bluetooth* device.

*If automatic connection is not achieved, or the headphones automatically connect to a different *Bluetooth* device than the one you wish to use, follow the instructions for the desired *Bluetooth* device regarding manual connection.

Controls when listening to music

If the connected *Bluetooth* device supports AVRCP, the following operations can be used.

- (+) button
 - Press once : Advance to next track or chapter.
 - Press and hold : Increase volume.
- (-) button
 - Press once : Return to beginning of track or chapter.
 - Press and hold : Decrease volume.
- (⏻) button
 - Press once : Play/Pause.

*When sound volume is set to maximum or minimum levels a beep sound will be produced from the headphones.

*Sound volume can be adjusted on the matching *Bluetooth* device.

*Depending on the specifications of the connected *Bluetooth* device, the controls noted above and controls on the *Bluetooth* device may not be supported.

*Depending on the specifications of the connected *Bluetooth* device, the music playback settings may need to be configured. Consult the user's manual for the *Bluetooth* device.

*Depending on the specifications of the connected *Bluetooth* device, a music playback application may start automatically or the music cannot be paused/played. Consult the user's manual for the *Bluetooth* device.

6. Vocal communication

To use the wireless headphones for vocal communication, pairing must be performed with the desired *Bluetooth* device using the “hands-free profile” (HFP) or “headset profile” (HSP).

For details on how to perform pairing, see P.4.

* If the *Bluetooth* device supports both profiles HFP and HSP, use the profile HFP.

(1) With power to the wireless headphones' turned off, hold the (⏻) button depressed for about three seconds.

The headphones' power will turn on and the LED indicator will flash blue.





(2) Turn on the *Bluetooth* function on the device you wish to connect to.

When pairing is completed, the wireless headphones will automatically connect to the *Bluetooth* device.

* If automatic connection is not achieved, or the headphones automatically connect to a different *Bluetooth* device than the one you wish to use, follow the instructions for the desired *Bluetooth* device regarding manual connection.

Vocal communication controls

If the connected *Bluetooth* device supports AVRCP, the following operations can be used.

- (+) button
 Press and hold : Increase volume.
- (–) button
 Press and hold : Decrease volume.
- (⏻) button
 -  Press once when receiving a message : Enables conversation.
Press once again to end conversation.
 -  Press and hold when receiving a message : Refuse communication.
 -  Press twice : Performs redialing.

The same controls are supported in the event a call is received while listening to music.

* When sound volume is set to maximum or minimum levels a beep sound will be produced from the headphones.

* Sound volume can be adjusted on the matching *Bluetooth* device.

* Depending on the specifications of the connected *Bluetooth* device, the controls noted above and controls on the *Bluetooth* device may not be supported.

* Depending on the specifications of the connected *Bluetooth* device, the phone settings may need to be configured. Consult the user's manual for the *Bluetooth* device.

7. LED indicator

Operation	LED indicator
When not connected to a <i>Bluetooth</i> device	LED flashes blue twice every one second.
Pairing mode	LED alternately flashes blue and red.
When connected to a <i>Bluetooth</i> device	LED flashes blue once every three seconds.
During recharging	LED lights red.

8. Troubleshooting

Problem	Remedy
Power won't turn on.	Recharge the wireless headphones.
The batteries will not charge.	Confirm that computer's power is ON.
	Confirm that computer is not in power-saving mode.
	Confirm that accessory micro-USB cable is securely connected to both the wireless headphones and the computer.
Can't perform pairing.	Place the wireless headphones and <i>Bluetooth</i> device closely together when performing pairing.
Can't perform <i>Bluetooth</i> connection.	Confirm that power is turned on for both wireless headphones and <i>Bluetooth</i> device.
	Confirm that <i>Bluetooth</i> function is turned ON in the device you are connecting to.
No sound. (When playing music)	Confirm that power is turned on for both wireless headphones and <i>Bluetooth</i> device.
	Confirm that connection with <i>Bluetooth</i> device is set for profile A2DP.
	Confirm that the connected music playback device is set for PLAY.
	Confirm that sound volume controls on both wireless headphones and music playback device are set to appropriate levels.
Sound is distorted. (When playing music)	Check that no other devices utilizing the 2.4 GHz wavelength (including microwave ovens, wireless radios, etc.) are nearby, and that no obstructions block the signal path.
Can't use hands-free operation.	Confirm that wireless headphones and <i>Bluetooth</i> device are connected using the profile HFP or HSP.
	If connection to the <i>Bluetooth</i> device is in profile A2DP, it may be necessary to change connection profiles (depending on the specifications of the <i>Bluetooth</i> device).

Problem	Remedy
Communication distance is short, sound is garbled.	Check that no other devices utilizing the 2.4 GHz wavelength (including microwave ovens, wireless radios, etc.) are nearby, and that no obstructions block the signal path.

Specifications

Transmission format	Bluetooth Standard Protocol Ver. 3.0
Output.....	Bluetooth Standard Protocol Power Class 2
Maximum transmission distance	About 10 m line of sight *1
Frequency used	2.4 GHz (2.4000 GHz to 2.4835 GHz)*2
Modulation	FHSS
Supported Bluetooth profiles	A2DP, AVRCP, HFP, HSP
Supported CODEC	SBC, AAC
Contents protection	SCMS-T
Battery life with continuous use	Maximum 15 hours of continuous transmission (including music-play time)
Recharging time	About 4 hours
Power	DC 3.7 V internally rechargeable lithium-ion battery
Weight.....	170 g

HEADPHONES

Type	Fully-enclosed dynamic headphones
Driver units	∅40 mm
Frequency response.....	10 Hz to 22 000 Hz
Ear pad.....	Polyurethane (leather finish)

MICROPHONE

Type	Electret condenser type
Directionality	Omni-directional microphone
Frequency response.....	20 Hz to 16 000 Hz

ACCESSORIES

Micro-USB cable.....	1
Warranty (Europe / U.S.A. and Canada / Japan).....	1
Quick Start Guide.....	1
Safety Guide	1

*1 Transmission distance is an approximation. Actual usable distance may vary depending on surrounding conditions.

*2 This product utilizes radio waves in the 2.4 GHz spectrum. Some signal dropouts may be experienced due to interference with radios, microwave ovens, and other devices using the 2.4 GHz spectrum.

Note

Specifications and design are subject to possible modifications without notice due to improvements.

Maximum radio-frequency power transmitted in the frequency band(s)
2400 MHz ~ 2483.5 MHz : 6 dBm

About the License and Trademarks

- “Pioneer” is a trademark of Pioneer Corporation, and is used under license.
- The *Bluetooth*® word mark and logos are registered trademarks owned by Bluetooth SIG, Inc. and any use of such marks by Onkyo Corporation is under license. Other trademarks and trade names are those of their respective owners.



2-3-12, Yaesu, Chuo-Ku, Tokyo 104-0028, Japan

Importer in EU

Hanns-Martin-Schleyer-Str. 35, 47877 Willich, Germany

Importer in US and Canada

Pioneer Home Entertainment U.S.A.

<U.S.A.>

18 PARK WAY, UPPER SADDLE RIVER, NEW JERSEY 07458, U.S.A.

Tel: 1-201-785-2600

<Germany>

Hanns-Martin-Schleyer-Straße 35, 47877 Willich, Germany

Tel: +49(0)2154 913222

<UK>

Anteros Building, Odyssey Business Park, West End Road, South Ruislip, Middlesex, HA4 6QQ United Kingdom

Tel: +44(0)208 836 3612

<France>

6, Avenue de Marais F - 95816 Argenteuil Cedex FRANCE

Tel :+33(0)969 368 050

Register your product on

<Europe>

<http://www.pioneer.eu>

<U.S.A.>

<http://www.pioneerelectronics.com>

<Canada>

<http://www.pioneerelectronics.ca>