

SAMSUNG

LED TV

Installation manual



Thank you for purchasing Samsung
product. To receive more service, please
register your product at
www.samsung.com

Model _____ Serial No. _____

Figures and illustrations in this Install Guide are provided for reference only and may differ from actual product appearance. Product design and specifications may be changed without notice.

Instruction

This TV is provided with interactive functionality through a set-back box (SBB/STB) connected to the TV, and with other TVs in a computer-controlled system for hotels and other hospitality businesses.

Interactive: When the TV is powered-up initially, it sends a command to identify the SBB/STB; if identified, the TV switches to ONLINE mode and full control is through the SBB/STB.

If the TV is in ONLINE mode, it stops receiving IR(Samsung remote) commands and acts according to interface protocol.

Stand-Alone: If SBB/STB is not identified, the TV should be switched to STAND-ALONE mode with restricted operation.

Operational Modes

This TV has two modes: Interactive and Stand-alone mode.

- **Interactive mode:** In this mode, the TV communicates with and is fully or partially controlled by a connected Set Back Box (SBB) or Set Top Box (STB) provided by a hospitality SI (System Integration) vendor. When the TV is initially plugged in, it sends a command that attempts to identify the SSB or STB connected to it. If the TV identifies the SBB or STB and the SBB or STB identifies the TV, the TV gives full control to the SBB or STB.
- **Stand-alone mode:** In this mode, this TV works alone without an external SBB or the STB.

The TV has a Hotel (Hospitality) Menu that lets you easily set its various hospitality functions. Please see pages 21 to 27.

The Menu also lets you activate or de-activate some TV and hospitality functions so you can create your optimal hospitality configuration.

Still image warning

Avoid displaying still images (like jpeg picture files) or still image element (like TV Program logo, panorama or 4:3 image format, stock or news bar at screen bottom etc.) on the screen. Constant displaying of still picture can cause uneven wear of screen phosphor, which will affect image quality. To reduce risk of this effect, please follow below recommendations:

- Avoid displaying the same TV channel for long periods.
- Always try do display any image on full screen, use TV set picture format menu for best possible match.
- Reduce brightness and contrast values to minimum required to achieve desired picture quality, exceeded values may speed up the burnout process.
- Frequently use all TV features designed to reduce image retention and screen burnout.

Securing the Installation Space

Keep required distances between the product and other objects (e.g. walls) to ensure proper ventilation.

Failing to do so may result in fire or a problem with the product due to an increase in the internal temperature.

- When using a stand or wall-mount, use parts provided by Samsung Electronics only.
 - Using parts provided by another manufacturer may result in a problem with the product or injuries due to the product falling.
- The appearance may differ, depending on the product.

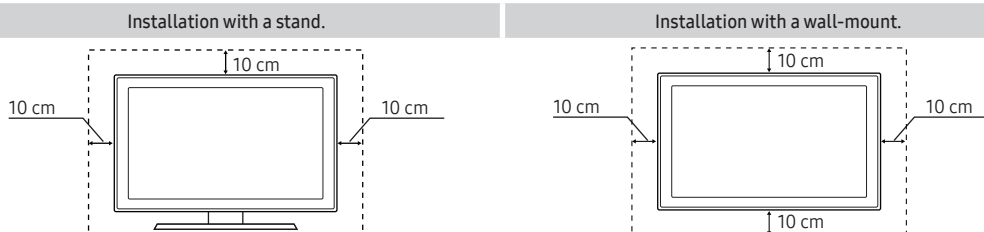

Contents

- Accessories..... 4
- Assembling the swivel..... 5
- Installing the LED TV Stand 6
- Viewing the Connection Panel..... 9
- TV Controller 12
- Viewing the Remote Control..... 13
- Connecting the TV with SBB 15
- Connecting the Bathroom Speakers 16
- Connecting the MediaHub HD 17
- Connecting the RJP (Remote Jack Pack) 18
- Connecting to a COMMON INTERFACE slot (Your TV viewing Card Slot) 20
- Setting the Hotel Option Data 21
- Installing the Wall Mount..... 69
- Securing the TV to the Wall..... 70
- Anti-theft Kensington Lock..... 70
- Specifications..... 71
- Dimensions..... 72
- Licence 74

Accessories

- Please make sure the following items are included with your LED TV. If any items are missing, contact your dealer.
- The items' colour and shapes may vary depending on the model.



- Remote Control & Batteries (AAA x 2)
- Quick Setup Guide
- Hotel Mount Kit (32 inch TVs or larger)
- Cable Holder
- Power Cord / Data Cable
- Warranty Card / Regulatory Guide (Not available in some locations)

- The stand and stand screw may not be included, depending on the model.
- The Data Cable may not be included, depending on the SI Vendor.

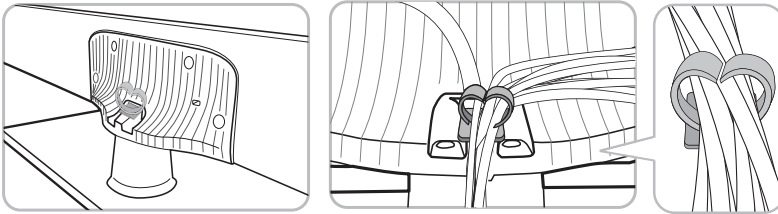
Arrange the cables using the Cable Holder



- For information on Samsung's environmental commitments and product-specific regulatory obligations, e.g. REACH, WEEE, Batteries, visit http://www.samsung.com/uk/aboutsamsung/samsungelectronics/corporatecitizenship/data_corner.html

	<p>Correct Disposal of This Product (Waste Electrical & Electronic Equipment) (Applicable in the European Union and other European countries with separate collection systems)</p> <p>This marking on the product, accessories or literature indicates that the product and its electronic accessories (e.g. charger, headset, USB cable) should not be disposed of with other household waste at the end of their working life. To prevent possible harm to the environment or human health from uncontrolled waste disposal, please separate these items from other types of waste and recycle them responsibly to promote the sustainable reuse of material resources. Household users should contact either the retailer where they purchased this product, or their local government office, for details of where and how they can take these items for environmentally safe recycling. Business users should contact their supplier and check the terms and conditions of the purchase contract. This product and its electronic accessories should not be mixed with other commercial wastes for disposal.</p>
	<p>Correct disposal of batteries in this product (Applicable in the European Union and other European countries with separate battery return systems.)</p> <p>This marking on the battery, manual or packaging indicates that the batteries in this product should not be disposed of with other household waste at the end of their working life. Where marked, the chemical symbols Hg, Cd or Pb indicate that the battery contains mercury, cadmium or lead above the reference levels in EC Directive 2006/66. If batteries are not properly disposed of, these substances can cause harm to human health or the environment. To protect natural resources and to promote material reuse, please separate batteries from other types of waste and recycle them through your local, free battery return system.</p>

Assembling the swivel

⚠ WARNING: If you configure the TV to swivel, you must attach it securely to the floor, a desk, a dresser top, etc. as described in the installation instructions.

The 32" and larger LED TVs have swivel stands. You can configure these stands so that the TVs swivel 20 degrees left and right, 60 degrees left and right, or 90 degrees left and right using the BRACKET HOLDER SWIVEL.

* The product ships with its stand's swivel angle set to 20°.

* 20° Swivel

To configure the TV so that it swivels 20° left and right, insert the prong on the bottom of the stand through the curved hole in the Bracket Holder Swivel marked 20°. Then, fix the Bracket Holder Swivel to the stand using the three supplied screws as shown below.

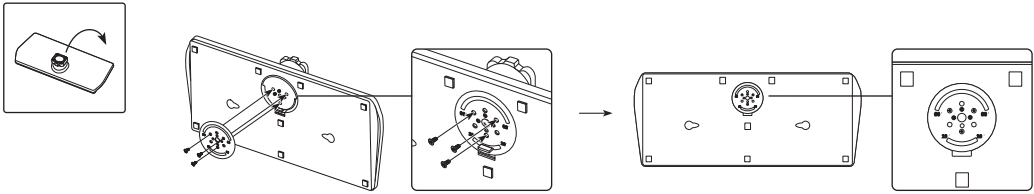

60° Swivel

To configure the TV so that it swivels 60° left and right, insert the prong on the bottom of the stand through the curved hole in the Bracket Holder Swivel marked 60°. Then, fix the Bracket Holder Swivel to the stand using the three supplied screws as shown below.

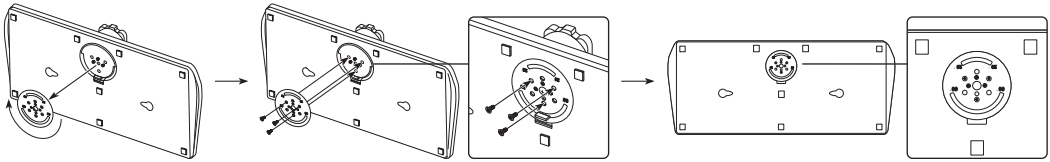

90° Swivel

To configure the TV so that it swivels 90° left and right, remove the Bracket Holder Swivel, and then screw the three supplied screws into the stand as shown below.

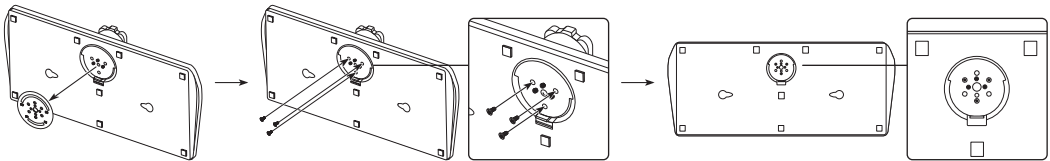



Installing the LED TV Stand

The 32" and larger LED TVs have swivel stands. You can set these stands so that the TVs swivel 20 degrees left and right or 90 degrees left and right.

Stand components

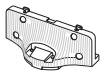
When installing the stand, use the provided components and parts.

A 	B 	C  32": BN96-29120C x 8 (M4 x L12) 49": BN96-18013E x 4 (M4 x L12)
Stand	Guide Stand	D  49": BN96-27704A x 4 (M4 x L12) Screws

1

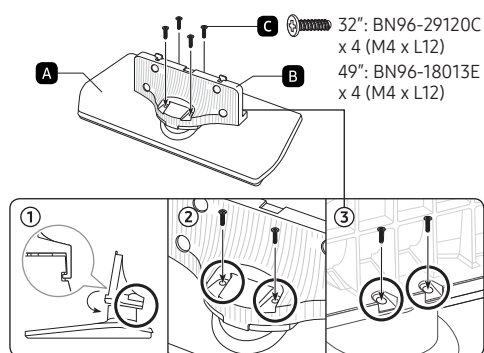

2

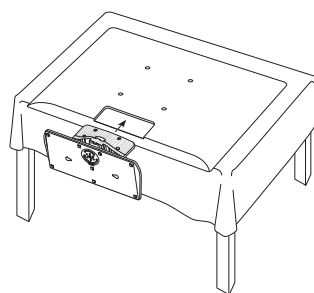

- Place a soft cloth over the table to protect the TV, and then place the TV on the cloth screen-side down.
- Insert the Stand Guide into the slot on the bottom of the TV.
- Slide and assemble it to the end line in the direction of arrow.

3

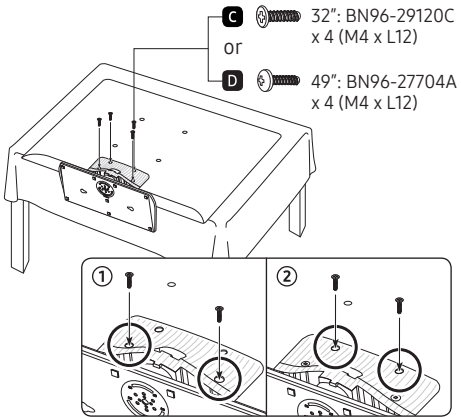

Tight the bottom screw first, and upper screw last.

- Progress the assembly of screw in the manual's order.

4







When the declination happened, try reassemble it **2** category.

- Make sure to assembling stand guide attached on the TV.

NOTE

- Make sure to distinguish between the front and back of each component when assembling them.
- Make sure that at least two persons lift and move the TV.

Hotel Mount Kit

A 	B 	C 	D 
Short Bolt (2EA)	Long Bolt (2EA)	Washer (2EA)	Nut (2EA)

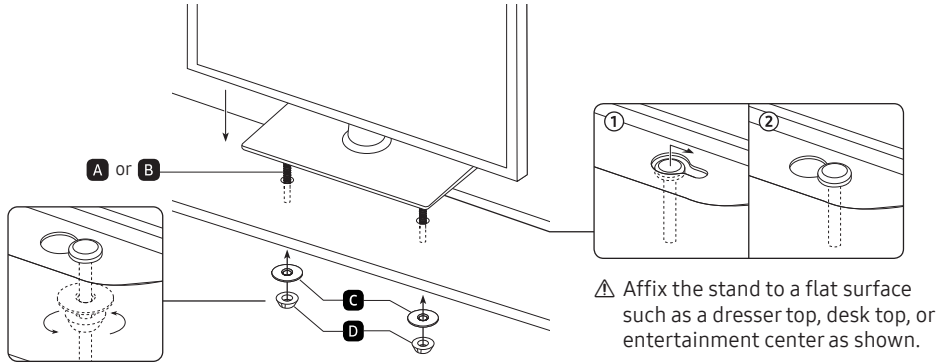

WARNING: To prevent injury, you must attach this TV securely to the floor, a table, a dresser top, etc. with the Hotel Mount Kit as described in these instructions.

Viewing the Connection Panel

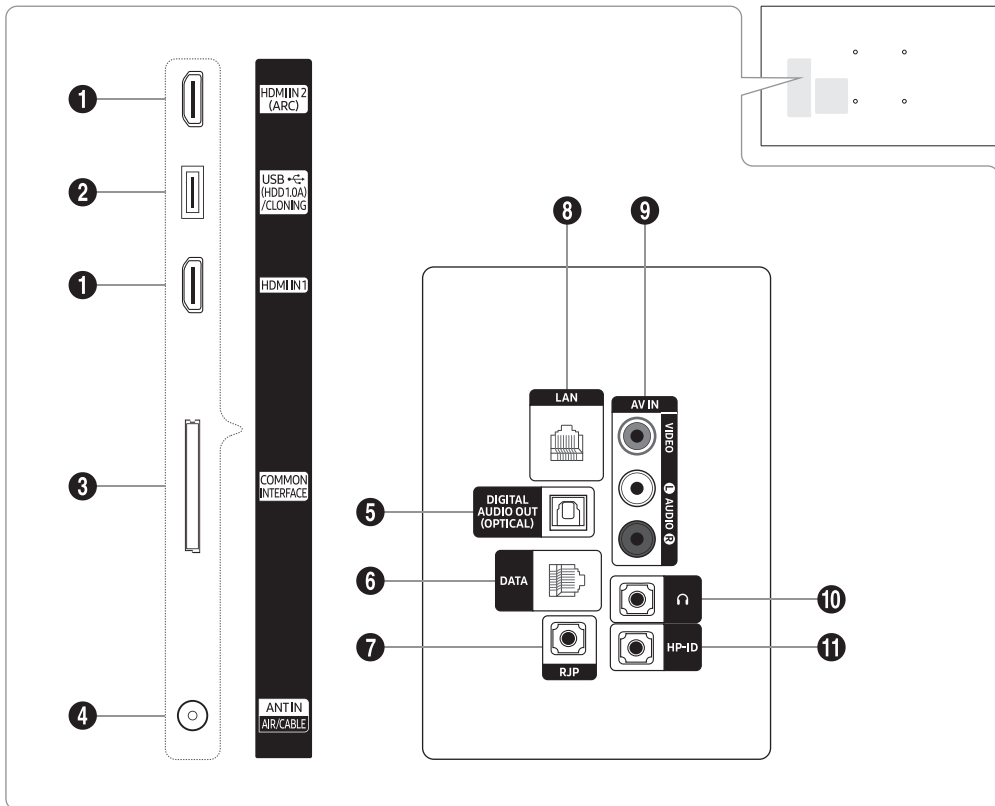

🔧 Whenever you connect an external device to your TV, make sure that power on the unit is turned off.

🔧 When connecting an external device, match the colour of the connection terminal to the cable.

1 HDMI IN 1 / HDMI IN 2 (ARC)

Connects to the HDMI jack of a device with an HDMI output.

🔧 No sound connection is needed for an HDMI-HDMI connection. HDMI connections carry both audio and video.

2 USB (HDD 1.0A) / CLONING

– Connector for software upgrades and Media Play, etc.

– Service connection.

3 COMMON INTERFACE

Attaching the CI or CI+ Card.

4 ANT IN (AIR/CABLE)

- To view television channels correctly, the TV must receive a signal from one of the following sources:
- An outdoor antenna / A cable television system

5 DIGITAL AUDIO OUT (OPTICAL)

Connects to a Digital Audio component.

6 DATA

- Used to support data communication between the TV and the SBB.
- Connects using RJ-12 TV type plugs.

7 RJP

This port is an RJP (Remote Jack Pack) communication port that enables connecting different devices to additional modules to improve device use and convenience.

8 LAN

Connect to a wired LAN using CAT 7 cable.

9 AV IN

- Connect audio cables to "L-AUDIO-R" on your TV and the other ends to corresponding audio out jacks on an A/V device.
- Connect RCA audio cables (optional) to "L-AUDIO-R" on the rear of the TV set and the other ends to corresponding audio out jacks on the external device.
- When connecting to AV IN, the colour of the AV IN [VIDEO] jack (yellow) does not match the colour of the video cable (yellow).

10 HEADPHONE JACK

Headphones may be connected to the headphone jack on your TV. While the headphones are connected, the sound from the built-in speakers is disabled.

11 HP-ID

Connect the cable to HP-ID and Headphone Jack simultaneously and connect it to separated Headphone Box. See page 16. When connecting Headphone to Headphone Box, it works same as Headphone function.

Display Modes

You can also select one of the standard resolutions listed in the Resolution column. The TV will automatically adjust to the resolution you choose.

After connecting a computer to the TV, set the screen resolution for the TV on the computer. If it is set to any other than in the table below, the TV may display nothing. Set the resolution properly, referring to the user guide of the computer or its graphic card.

The resolutions in the table are recommended.

 HG32EE590: Optimal resolution is 1366 x 768 @ 60 Hz.

 HG49EE590: Optimal resolution is 1920 x 1080 @ 60 Hz.

Mode	Resolution	Horizontal Frequency (KHz)	Vertical Frequency (Hz)	Pixel Clock Frequency (MHz)	Sync Polarity (H / V)
IBM	720 x 400	31.469	70.087	28.322	-/+
MAC	640 x 480	35.000	66.667	30.240	-/-
	832 x 624	49.726	74.551	57.284	-/-
	1152 x 870	68.681	75.062	100.000	-/-
VESA DMT	640 x 480	31.469	59.940	25.175	-/-
	640 x 480	37.861	72.809	31.500	-/-
	640 x 480	37.500	75.000	31.500	-/-
	800 x 600	37.879	60.317	40.000	+/+
	800 x 600	48.077	72.188	50.000	+/+
	800 x 600	46.875	75.000	49.500	+/+
	1024 x 768	48.363	60.004	65.000	-/-
	1024 x 768	56.476	70.069	75.000	-/-
	1024 x 768	60.023	75.029	78.750	+/+
	1152 x 864	67.500	75.000	108.000	+/+
	1280 x 1024	63.981	60.020	108.000	+/+
	1280 x 1024	79.976	75.025	135.000	+/+
	1280 x 720	45.000	60.000	74.250	+/+
	1280 x 800	49.702	59.810	83.500	-/+
	1280 x 960	60.000	60.000	108.000	+/+
	1366 x 768	47.712	60.015	85.500	+/+
	1440 x 900	55.935	59.887	106.500	-/+
1600 x 900RB	60.000	60.000	108.000	+/+	
1680 x 1050	65.290	59.954	146.250	-/+	
1920 x 1080	67.500	60.000	148.500	+/+	

 The interlace mode is not supported.

 The set might operate abnormally if a non-standard video format is selected.

 Separate and Composite modes are supported. SOG (Sync On Green) is not supported.

TV Controller

TV Controller is a multi directional button that helps navigate without using the remote control.

- Some functions which require a PIN code may not be available.
- The product colour and shape may vary, depending on the model.
- Exits the menu when pressing the controller for more than 3 second.
- The TV's Controller, a small joy stick like button on the bottom right side of the TV, lets you control the TV without the remote control.

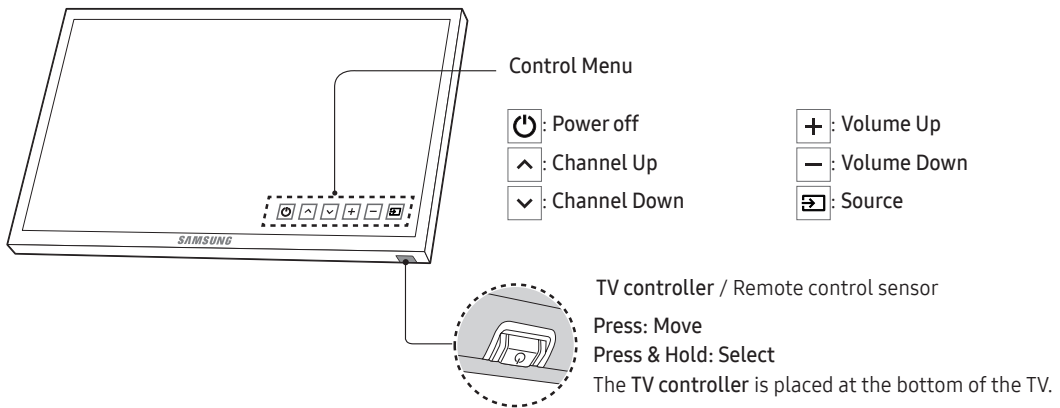

Standby mode

Do not leave your product in standby mode for long periods of time (when you are away on a holiday, for example). A small amount of electric power is still consumed even when the power button is turned off.

Viewing the Remote Control

- This remote control has Braille points on the Power, Channel, and Volume buttons and can be used by visually impaired persons.

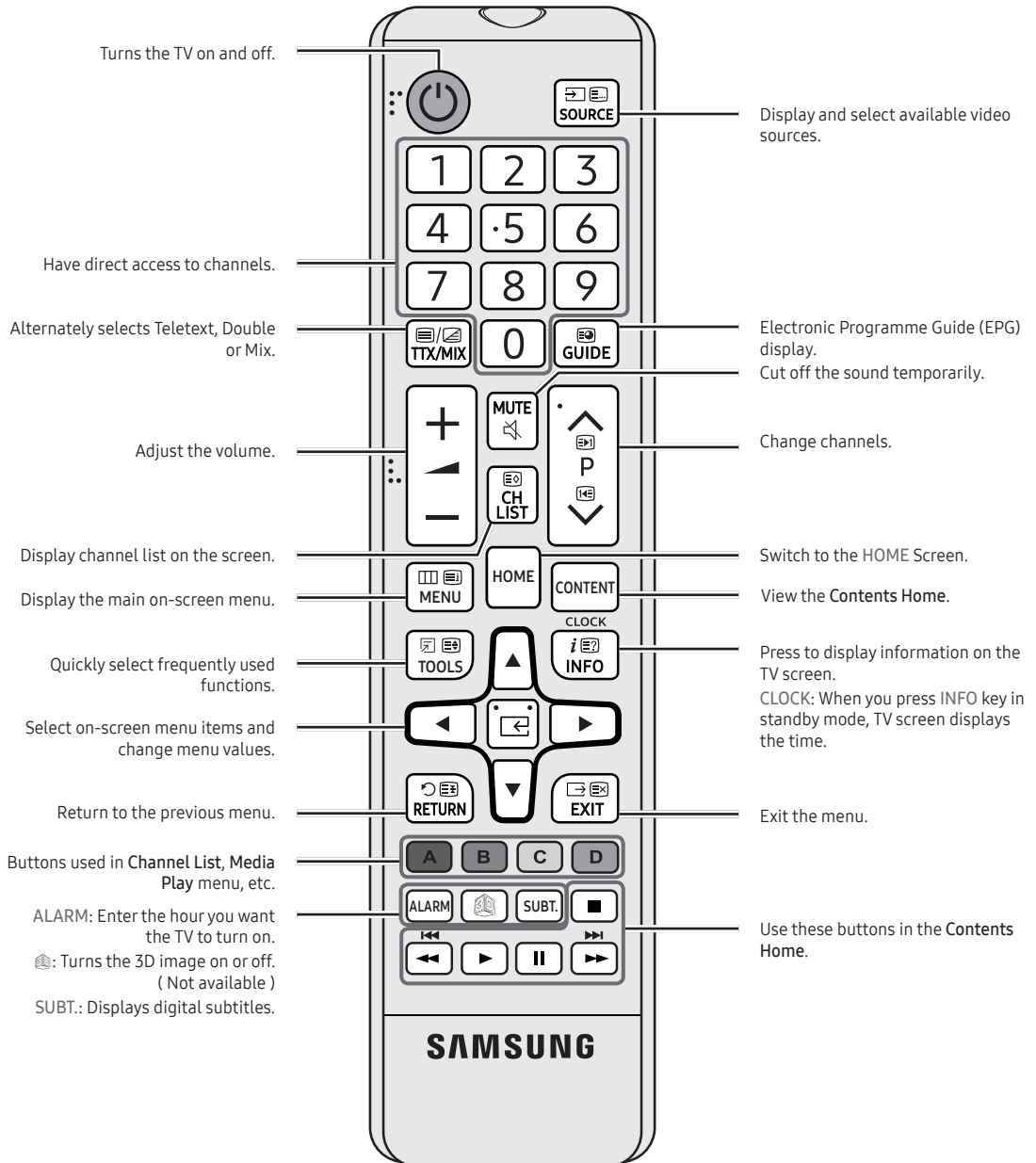

Installing batteries (Battery size: AAA)

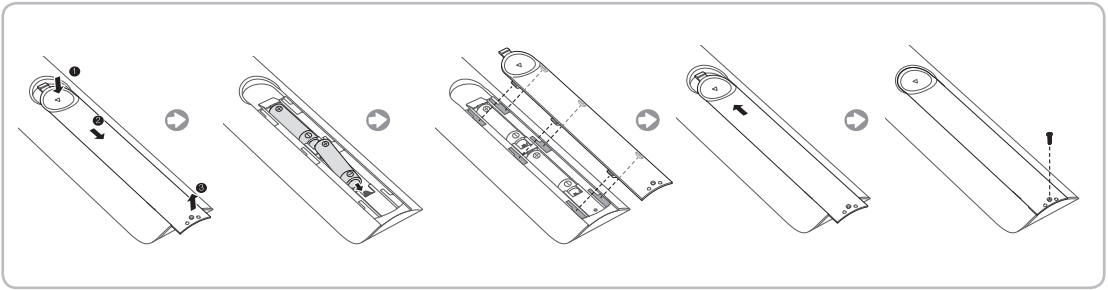

NOTE

- Use the remote control within 7m of the TV.
- Bright light may affect the performance of the remote control. Avoid using nearby special fluorescent light or neon signs.
- The colour and shape may vary depending on the model.
- Remote control button '3D' are not supported. When pressing this buttons, the TV unit does not respond.

Connecting the TV with SBB

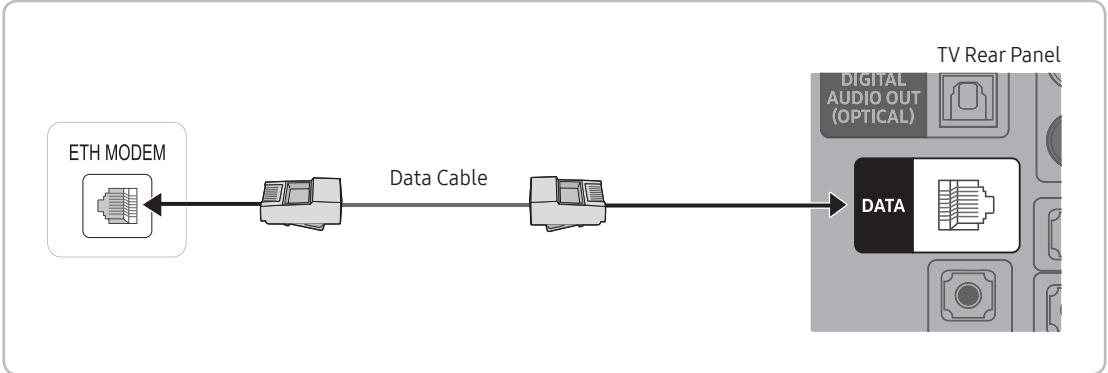

The rear panel may differ depending on the model.

1. Connect the DATA jack of the TV to the [ETH MODEM] jack of the STB (SBB) with the Data cable.
 - Use data communication.

List of Vendors and Compatible Data Cables Supplied with the TV

- Confirm that you are using the correct data cable for your vendor. Refer to the code label on the data cables.

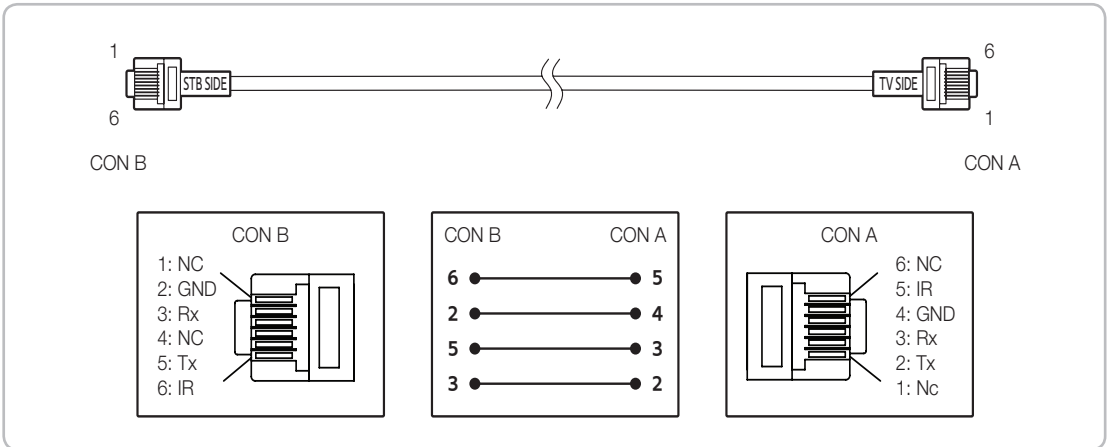

Operation Specification of Data Cable(RJ12) : RS232

Connecting the Bathroom Speakers

You can connect the Bathroom Speakers using the following method.

Audio Loop In

An additional Headphone Box can be installed on a bed or business desk for added convenience. The installation procedures are given below.

- Detailed Drawing of the Headphone Box.

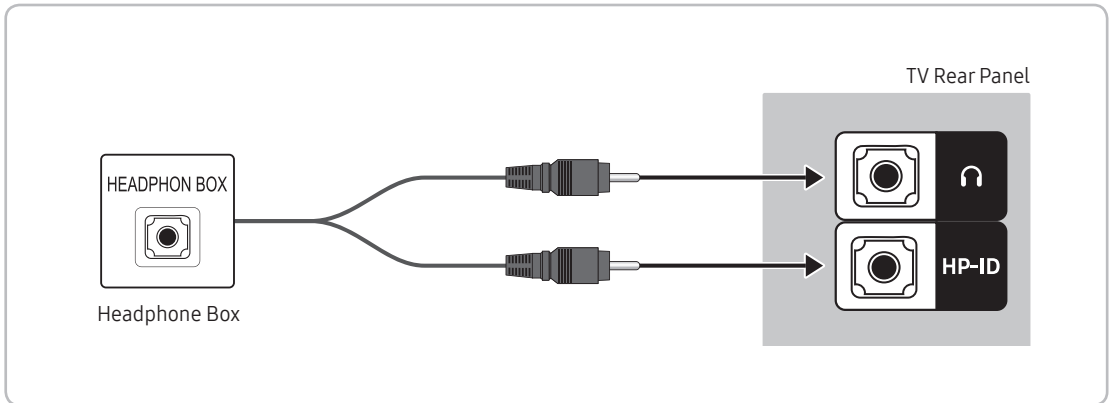

 The rear panel may differ depending on the model.

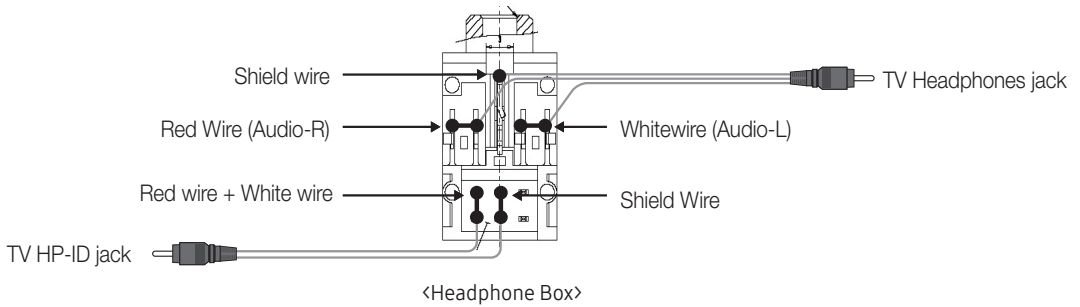

Connecting the MediaHub HD

Output to any external source connected to MediaHub HD on the hotel desk.

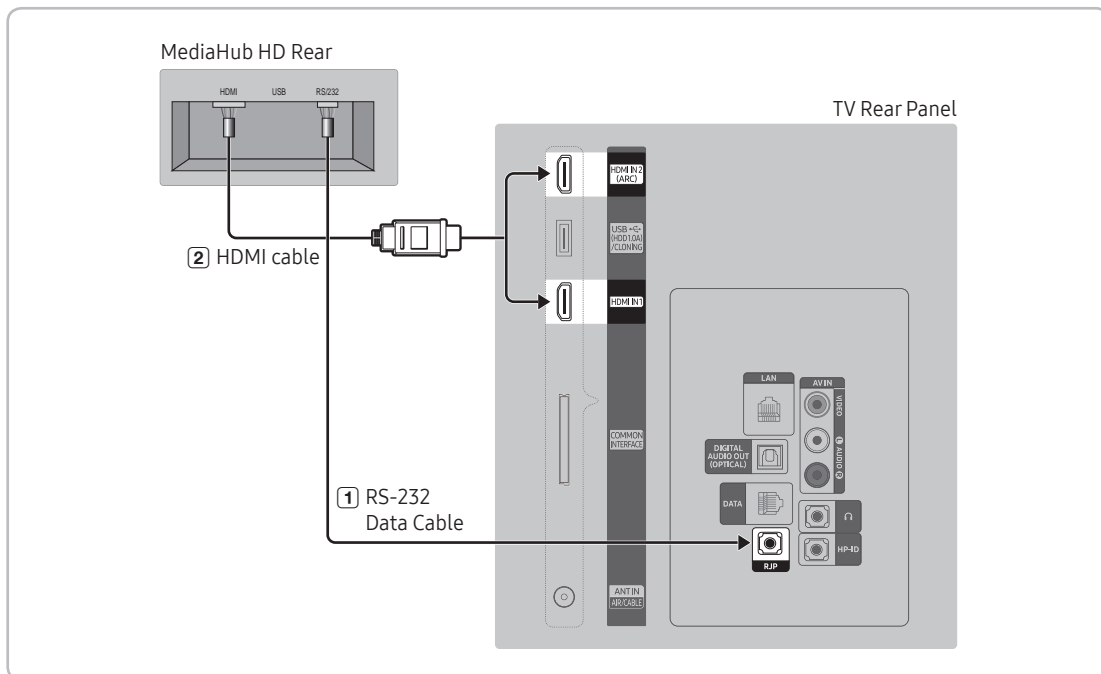

The rear panel may differ depending on the model.

1. Connect the RJP port of the TV and the RS/232 port of the MediaHub HD.
2. Connect the HDMI IN 1, 2(ARC) port of the TV and the HDMI port of the MediaHub HD.

- MediaHub HD

- The MediaHub HD is a hardware module that has different Audio Video inputs (A/V, Audio, PC, HDMI and USB) and corresponding outputs. The corresponding output sources connect from MediaHub to the TV. MediaHub communicates with the TV via RS232. Hot Plug & Play is a function that allows hotel guests to connect an external source to the MediaHub. MediaHub communicates with the TV by sending messages regarding Active/Inactive sources. The TV switches to the Active external source.
- You have to connect the HDMI of the MediaHub to the HDMI IN 1 port of the TV.
- When the TV is on, connect the TV and the RJP within 10 seconds.

- Special features

- PIP
- Auto Detection

Connecting the RJP (Remote Jack Pack)

Output to any external source connected to RJP on the hotel desk.

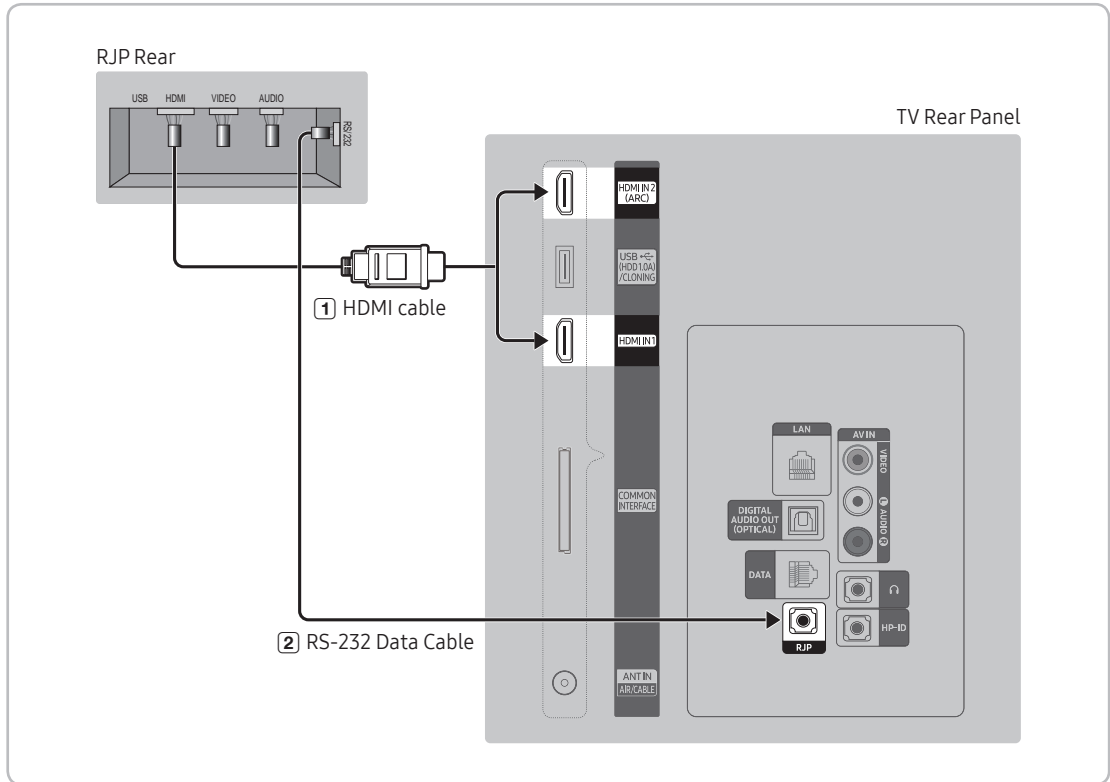

🔗 The rear panel may differ depending on the model.

1. Connect the HDMI IN 1, 2(ARC) port of the TV and the HDMI port of the RJP.
2. Connect the RJP port of the TV and the RS/232 port of the RJP.

🔗 The RJP (Remote Jack Pack) compatible with this Samsung TV is TeleAdapt TA-7610, TA-7650 (HD) and TA-7660 (HD Plus).

- **RJP (Remote Jack Pack):** RJP stands for Remote Jack Pack. The RJP is a hardware module that has different Audio Video inputs (A/V, Audio, PC and HDMI) and corresponding outputs. The corresponding output sources are connected from RJP to TV. The RJP communicates with the TV via RS232. Hot Plug & Play is a function that allows hotel guests to connect an external source to the RJP. The RJP communicates with the TV by sending messages regarding Active/Inactive sources. The TV will switch to the Active external source according to the priority set by the User.

🔗 You can select HDMI IN 1, 2(ARC) and AV IN for connecting RJP.

🔗 When the TV is on, connect the TV and the RJP within 10 seconds.

- The RJP can be returned to the factory default settings by pressing the A/V and HDMI buttons simultaneously for 10 seconds. All LEDs blink 5 times to acknowledge that this has been finished.
- The RJP will automatically turn off any LEDs after 5 minutes to avoid unnecessary light pollution in the hotel room. The LEDs that were turned off will turn on again if the guest touches any of the buttons and the 5 minute timer will restart. If the guest then touches another source button, the TV will change to the selected source and the corresponding LED will be lit.
- After an RJP Reset or a TV Power OFF/ON, it takes approx. 10 seconds to establish communications between the TV and the RJP.
- The following table shows the approximate time in seconds to switch from the TV to the input source, based on the priority.
 - ✎ Scenario 1: When no inputs are connected.

Source	To Connect
AV	2 Sec
HDMI	3.9 Sec

- ✎ Scenario 2: When two or more inputs are connected and an Input source is disconnected and then reconnected.

Source	Disconnect	To Connect	Total
AV	4.5 Sec	2 Sec	6.5 Sec
HDMI	3.9 Sec	3.9 Sec	7.8 Sec

- ✎ E.g. If the RJP has all its live sources AV, PC and HDMI connected, AV is viewed as the highest priority. If the RJP is in HDMI mode, and a guest removes and reconnects the AV, the minimum time required to switch to the AV is 6.5 seconds.
- To connect audio (Ipod or Mp3), Music mode should be ON and Jack Ident detect should be OFF.
- A/V, PC and HDMI input sources are supported.

Connecting to a COMMON INTERFACE slot (Your TV viewing Card Slot)

- Depending on the country and model.
- Turn the TV off to connect or disconnect a CI or CI+ card.

Using the “CI or CI+ CARD”

To watch paid channels, the “CI or CI+ CARD” must be inserted.

- If you don't insert the “CI or CI+ CARD”, some channels will display the message “Scrambled Signal”.
- The pairing information containing a telephone number, the “CI or CI+ CARD”, the Host ID and other information will be displayed in about 2~3 minutes. If an error message is displayed, please contact your service provider.
- When the configuration of channel information has finished, the message “Updating Completed” is displayed, indicating the channel list is updated.

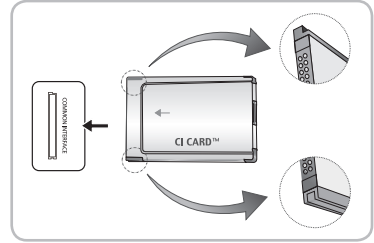

- The image may differ depending on the model.

NOTE

- You must obtain a “CI or CI+ CARD” from a local cable service provider.
- When removing the “CI or CI+ CARD”, carefully pull it out with your hands since dropping the “CI or CI+ CARD” may cause damage to it.
- Insert the “CI or CI+ CARD” in the direction marked on the card.
- The location of the COMMON INTERFACE slot may be different depending on the model.
- “CI or CI+ CARD” is not supported in some countries and regions; check with your authorized dealer.
- If you have any problems, please contact a service provider.
- If the screen is distorted or is not seen, insert the “CI or CI+CARD” that supports aerial settings.

Setting the Hotel Option Data

To enter: Press the MUTE → 1 → 1 → 9 → ENTER  buttons in order. (From the Hospitality mode, the Standalone mode is set.)

To exit from this menu : power off and turn on again.

 Depending on Model and Region, some menus do not exist on the TV set.

Hotel TV Function			Description
Category	Item	Initial value	
Hospitality Mode	Hospitality Mode	Standalone	Select Hospitality mode. <ul style="list-style-type: none"> Interactive mode : TV works with an SI STB or SBB. Standalone mode : TV works alone, without an SI STB or SBB.
SI Vendor	SI Vendor	OFF	<ul style="list-style-type: none"> Interactive mode : Samsung / 2M / Locatel / VDA / VDA-S / Acentic / Sustinere / Quadriga / ETV / IBahn / Magilink / Otrum / Siemens / Amino / MDC / Enseco Standalone mode : OFF / Movielink / Swisscom / Smoovie / SSCP
Power On	Power On Channel	Last Saved	Set the default values that will be applied when the TV is turned on. <ul style="list-style-type: none"> User Defined : Lets you set Power On Channel and Channel Type manually. See Power On Channel and Channel Type below. Last Saved : If you select this item, when the TV is turned on, it displays the channel it was displaying when it was turned off.
	Power On Channel Num	1	When the TV is turned on, it switches automatically to this channel.
	Power On Channel Type	ATV	Select channel band : AIR (analogue air band), DTV (digital air band), CATV (analogue cable band), CDTV (digital cable band)
	Power On Volume	Last Saved	<ul style="list-style-type: none"> User Defined : Lets you set the Power On Volume manually. See Power On Volume below. Last Saved : When the TV is turned on, it returns to the volume that had been set when the power had been turned off.
	Power On Volume Num	10	The TV turns on with this Volume Level in Stand Alone Hospitality mode.
	Min Volume	0	The minimum Volume Level the user can set in Stand Alone Hospitality mode.
	Max Volume	100	The maximum Volume Level the user can set in Stand Alone Hospitality mode.
	Power On Source	TV	Select the input source the TV displays when turns on.
	Power On Option	Last Option	Determines the TV's state when power returns after a power failure or after you have unplugged the TV and then plugged it in again. <ul style="list-style-type: none"> Last Option : Returns to its last Power state. If it was in Stand-by, it returns to Stand-by. If it was on, it turns on. Power On : When the power returns, the TV turns on. Standby : When the power returns, the TV enters the Standby mode.

Hotel TV Function			Description
Category	Item	Initial value	
Channel	Channel Setup		Gives you direct, immediate access to some of the Channel menu functions on the user Channel menu such as Auto Tunning, Antenna selection, etc.
	Channel Editor		The Channel Editor lets you edit the channels stored in the TV's memory. Using Channel Editor you can: <ul style="list-style-type: none"> • Change the channel numbers and names, and sort the channels in your desired channel number order. • Apply the video mute to channels you select. The video mute blanks out the video from a channel and outputs only the sound while displaying a speaker icon on the screen. The Channel Editor also lets you view information about each channel easily, without your having to display each channel directly.
	Mixed Channel Map	ON	This Feature enables showing/browsing all antenna type (Air/Cable or Satellite) channels at the same time. <ul style="list-style-type: none"> • ON: When ON, guests can access the complete Channel Map irrespective of the selected antenna type. The Channel list will also populate Air as well Cable type channels. • OFF: When OFF, guest can access the Channel Map corresponding to the selected antenna type [AIR/CABLE or Satellite] only. The Channel list/Editor will only show the selected antenna type channels.
	Dynamic SI	OFF	<ul style="list-style-type: none"> • ON: Check the DTV Programme channel number. (the TV channel editor is inaccessible) • OFF: Do not check the DTV Programme channel number. (the DTV channel editor is accessible, but additional channel Programme number update is not supported)
	Channel Rescan Message	ON	When there is a mismatch between the data in the channel map and the transmitted data, the TV autotunes the channels to restore the data/parameters in the channel map. <ul style="list-style-type: none"> • ON: When Channel Rescan Message is ON, The OSD showing that the channels are being rescanned will be displayed to Hotel Guests. • OFF: A Hotel Admin can turn the Channel Rescan Message OFF, if the rescan message OSD should not to be displayed to Hotel Guests.
	Pan Euro MHEG	OFF	<ul style="list-style-type: none"> • OFF: If Pan Euro MHEG is set to Off, MHEG runs according to the existing product specifications. • ON: If Pan Euro MHEG is set to On, MHEG is ON regardless of the product specifications or region.
	My Channel	OFF	Enable or disable the My Channel feature.
	Genre Editor	..	Edit the genre for channels. (Available when My Channel is On)
	Subtitle Auto On	OFF	This function turns the function On/Off that automatically turns on the subtitles in a specific country. This function is supported for Hotel TVs that are ready to receive DVB broadcasts that is heading to Europe. This function is related to France's subtitle specification. The rest of the countries' subtitles function according to the appropriate country specifications regardless of the Subtitle Auto On function. <ul style="list-style-type: none"> • ON: When the Subtitle Auto On function is ON, it follows France's subtitle specifications. • OFF: When the Subtitle Auto On function is OFF, it does not follow France's subtitle specifications.
	TTX Widescreen Mode	OFF	Widen the subtitle section to fit the screen width.

Hotel TV Function			Description
Category	Item	Initial value	
Menu OSD	Picture Menu Lock	OFF	Enable or disable the Picture Menu.
	Menu Display	ON	<ul style="list-style-type: none"> • ON : Main Menu display. • OFF : Main Menu No display.
	Tools Display	ON	Hide or show the Tools menu.
	Channel Menu Display	OFF	Hide or show the Channel menu.
	Panel Button Lock	Unlock	Turning the front panel (local key) operations on/off. <ul style="list-style-type: none"> • Unlock : Unlocks all panel keys. • Lock : Locks all panel keys. • OnlyPower : Locks all panel keys except the Power panel key. • Menu/Source : Locks the Menu and Source panel keys.
	Home Menu Display	ON	<ul style="list-style-type: none"> • OFF : The Home Menu is not displayed. • ON : The Home Menu is displayed.
	Home Menu Editor		Edit Home Menu
	Home Menu Auto Start	ON	<ul style="list-style-type: none"> • ON : The Home Menu is Auto Start. • OFF : The Home Menu is not Auto Start.
Clock	Clock Type	OFF	<ul style="list-style-type: none"> • OFF : No clock option of Factory menu shall work. Only Main menu. • SW Clock : SW clock shall work only.
	Local Time	Manual	Select the method to update the clock data. <ul style="list-style-type: none"> • Manual: Use clock data from DVB channel or manual clock setting When the TV is in the stand-alone mode. • TTX: Bring up the time information from the TTX stream. • Time Channel: Use clock data from the selected Channel type and Channel num.
	Timer Type	WakeUp	Enable or disable the alarm function. <ul style="list-style-type: none"> • WakeUp : Enable the alarm function to turn on the device at the specified time. • OnOff : Disable the Alarm function.
Music Mode	Music Mode AV	OFF	To get music output from an mp3/audio player through an AV Input Source. When on, you can hear sound from the player through the TV even there is no video signal. The TV's backlight, however, remains on. And add a video signal, it works normally.
	Music Mode Backlight	OFF	Backlight On/Off option in Music mode to save energy
Remote Jack Pack	Priority AV	1	If the jack priority is set, the corresponding source is automatically set when a jack is inserted according to the jack priority
	Priority HDMI	3	If the jack priority is set, the corresponding source is automatically set when a jack is inserted according to the jack priority.
	AV Option	AV	Select RJP AV Source (Source selection depends on Model).
	HDMI Option	HDMI 1	Select which HDMI source of the TV is connected to the RJP jack. (HDMI1/HDMI2/HDMI3)

Hotel TV Function			Description
Category	Item	Initial value	
External Source	USB Pop-up Screen	Default	When USB is connected to the TV, <ul style="list-style-type: none"> • Default : A Popup window appears. • Automatic : This Enters the USB content menu automatically. • Disable : Neither the pop-up window nor the menu appears.
	External Source Banner	ON	Users can set External Source Banner to On or Off. <ul style="list-style-type: none"> • ON : When TV power is On or the Mode changes, the TV will displays the external source banner. • OFF : When TV power is On or the Mode changes, the TV does not display the external source banner.
	Auto Source	OFF	<ul style="list-style-type: none"> • OFF : Auto Source is Off. • ON : When an external source is connected to the TV, the TV will auto-ident and switch the input source. • PC : Auto Ident PC Input only.
	Anynet+ Return Source	Power On Src	Select the return TV source after stopping an Anynet+(HDMI-CEC) connection. (This fuction is especially useful for the Guestlink RJP)
HP Management	HP Mode	OFF	<ul style="list-style-type: none"> • ON: When the Headphone is connect to the TV, allows you to listen to audio through the TV's speakers and the connected headphones simultaneously. But, you can only adjust the volumes of TV speaker. • OFF: When the Headphone is connect to the TV, allows you to listen to audio through the connected headphones only.
	Default HP Volume	10	Configure the values of headphones' volume when HP MODE is set to ON.
	Main Speaker	ON	<ul style="list-style-type: none"> • ON: Plays the TV sound through the TV speaker. • OFF: Plays the TV sound through the headphones only.
Eco Solution	Energy Saving	OFF	Adjusts the brightness of the TV to reduce power consumption. <ul style="list-style-type: none"> • Off: Turns off the energy saving function. • Low: Sets the TV to low energy saving mode. • Medium: Sets the TV to medium energy saving mode. • High: Sets the TV to high energy saving mode.
Logo/ Message	Welcome Message	OFF	Displays on Welcome Message.
	Edit Welcome Message		Edit the Welcome Message.
	Hospitality Logo	OFF	Turns the Hospitality logo feature OFF, BMP, AVI, BOTH. If not OFF, when the TV is turned on, the Logo is displayed, before the signal from the initial source, for the amount of time set in "Logo Display Time". <ul style="list-style-type: none"> • The DivX codec is not supported.
	Hospitality Logo DL	..	Downloads the Hospitality logo. Hospitality logo file requirements: <ul style="list-style-type: none"> • BMP or AVI files only. • Max file size : BMP - 960 X 540. AVI - 30MB. • The file can only be named samsung.bmp or samsung.avi.
	Logo Display Time	..	Set the logo display time (3/5/7 Seconds).
Cloning	Clone TV to USB		Clone the current TV option values to a USB memory device.
	Clone USB to TV		Clone the saved TV option values in a USB memory device to the TV.
	Setting Auto Initialize	OFF	When Setting Auto Initialize is set to On, and the power is turned off and on or the Master Power is turned off and on, the data is restored to the cloned values. If there is no cloned value, even when the Setting Auto Initialize is set to On, it will be ignored and the operation will be the same as that when Setting Auto Initialize is set to Off

Hotel TV Function			Description
Category	Item	Initial value	
REACH Solution	REACH	OFF	<ul style="list-style-type: none"> • ON: The feature of REACH in this TV becomes available. • OFF: The feature of REACH in this TV becomes not available.
	REACH IP Mode	...	If enabled, Reach will work over IP instead of RF.
	Server IP Setting	...	The URL of the Reach IP server, for example https://192.168.1.2:443.
	REACH Channel	...	Assign a DTV channel number to carry the update REACH data. This channel number must be the same as the number set on the Reach server.
	REACH Update Time	...	Lets you set when data such as updated SW, cloning files, and S-LYNC REACH contents is downloaded from the REACH server to the TV : 1hour: Every hour 2hour: Every 2 hours 12:00 AM: every 12:00 a.m. 2:00 AM: every 2:00 a.m. 12:00 PM: every 12:00 p.m. 2:00 PM: every 2:00 p.m.
	REACH Update Immediate	...	<ul style="list-style-type: none"> • ON: Whenever the TV enters standby mode (the power cord is plugged in and the power is off), the REACH data is updated on the TV. • OFF: The REACH data is only updated on the TV at the REACH server update time.
	Group ID	...	Select the Group ID of the REACH server. (Refer to the REACH server manual for more details.)
	Room Number	...	Set the Room Number.
	REACH Config Version	...	The version of REACH is displayed.
Network	Network Setup		Set an IP address to establish an Internet connection. Soft AP: Using this function, you can connect the TV on your mobile devices. Set the options for connection of Wi-Fi device. <ul style="list-style-type: none"> • Soft AP: Turns on or off the Soft AP. When Soft AP is set to On, your mobile devices can find the TV name in Wi-Fi connection list. • Security key: Set a security key that you need to enter on other devices so they can connect to the TV. <ul style="list-style-type: none"> – Input the generated security key into the device you want to connect. – If network does not operate normally, check the security key again. An incorrect security key may cause a malfunction. <ul style="list-style-type: none"> ☞ Soft AP may not be available if it is not supported by the model. ☞ Maximum number of devices that can be connected: 4 devices. ☞ Bitrate : 10 Mbps/device. ☞ The specifications above are based on our in-house testing. Actual performance may vary depending on your wired/wireless network environment.
	SmartHub Model Setting		Set Smart Hub Model.
	SmartHub Setting		Set up Smart Hub.
	Service Discovery	On	If this option is set to On, you can share content with other devices, such as smartphones, in DLNA mode.

Hotel TV Function			Description
Category	Item	Initial value	
Widget Solution	Widget Mode	ON	Widget Mode On/Off.
	Solution Type	Vendor Server	Select type of solution (Vender Server/ SINC Server).
	Server URL Setting		Set server URL.
	License Server IP Setting	...	Set server IP.
	IPTV Mode	ON	IPTV mode On/Off.
	Room Num Setting		Set the Room Number.
	HMS HalfTicker Display		Set to On if you want to use the HalfTicker UI. When set to Off, the HalfTicker UI will not be displayed. However, all the hot keys (except for Room Control key) on the HMS remote control will work normally without the HalfTicker UI display.
Virtual Standby	Virtual Standby Mode	OFF	TV can supply the main feature in the standby mode if The TV mode is set to the Virtual Standby mode. <ul style="list-style-type: none"> • ON: The Virtual Standby mode is enable. • OFF: The Virtual Standby mode is disable. When Virtual Standby is On, TV power consumption will be 9.5W to 17.4W (Depending on the size of the TV screen).
	Reboot Time	...	This Feature can set the Reboot interval of TV after TV enters Virtual standby Mode.
Security Mode	Factory Lock	OFF	Delete Device List in when power on or off. <ul style="list-style-type: none"> • ON: The password is needed before entering factory menu. • OFF: disable this feature.
	Password Popup	...	Enable/disable Password Popup. If this option is set to OFF, the TV will not display the password input popup window when entering the Factory menu. If set to ON, the password input popup window appears.
	Password Input	...	If this option is enabled, a popup input box appears which asks for an 8-character security password. The admin must enter a password before applying or updating security preferences. After the correct password is entered, options such as Password Setting, Password Reset and Security Mode are available.
	Password Setting	...	User can change the password.
	Password Reset	...	Password is reset to "00000000".
	Security Mode	...	Security Mode provides password protected administrative functionality to enable or disable features of Hospitality TV, such as HDMI, USB and TTX. Use this option to turn security mode on or off. After turning on security mode, options such as "USB," "HDMI" and "TTX Security" are automatically enabled in the security sub-menu. "USB to TV cloning" and "TV Reset" will be disabled in the Hospitality Menu.
	USB	...	Enable/disable USB access. When disabled, access to USB media is blocked.
	HDMI	...	Enable/disable HDMI access. If disabled, Anynet, HDMI source, HDMI type External Channels will not be accessible to the user.
TTX Security	...	If this option is disabled, the TTX feature will not work when the TTX button is pressed on the remote control.	
DRM	DRM Mode	OFF	Configures DRM support. OFF: Turns off DRM support. LYNK DRM: Select to turn on S-LYNK DRM CAS support only. Pro:Idiom: Select to turn on Pro:Idiom CAS support only. LYNK DRM,PI: Select to have the TV support S-LYNK DRM CAS and Pro:Idiom CAS.

Hotel TV Function			Description
Category	Item	Initial value	
System	Self Diagnosis for TV		Enter Self Diagnosis Menu. <ul style="list-style-type: none"> • Picture Test: Use this test when you experience a problem with your TV's picture. • Sound Test: Use this test when you experience a problem with your TV's sound. • Signal Information: Show digital broadcasting signal information. • Reset: Restore all TV settings, excluding network settings, to the factory defaults.
	Self Diagnosis for HTV		Use this function to check the statuses of the main functions of Hotel TV. <ul style="list-style-type: none"> • STB SI Vendor Setting <ul style="list-style-type: none"> – Lets you check the state of Pro:Idiom and its communication with the SI STB or SBB. – If you have any problems with the Pro:idiom encryption channel or the communications with the SI STB or SBB, use this diagnosis function. – If "Pro:Idiom DTV Channel Key Loss" appears to have failed and the Pro:Idiom encryption channel has failed to play content, first check the broadcasting systems related to Pro:Idiom encryption. – If your broadcasting system does not have a problem, contact Samsung Service. – If STB SI Vendor Setting appears to have failed and communication with the SI STB or SBB has failed, first check your SI STB or SBB. If your SI STB or SBB does not have a problem, contact to Samsung Service. • RTC <ul style="list-style-type: none"> – If the time settings does not match when you turn off and on the TV, use this function. – If the time settings does not match, contact Samsung Service.
	SW Update		SW USB Update function
	Service Pattern	OFF	Same function with SVC Service Pattern
	Sound Bar Out	OFF	ON: TV speaker sound will be mute. Sound will come out through HDMI. You must connect the Sound Bar to hear the sound. OFF: Sound will come out through TV speakers normally.
	Contact Samsung		Display the web site of related Samsung service center, software version, and Mac address information.
	Standby LED	ON	When the TV is in standby mode, you can configure the settings of external LED. <ul style="list-style-type: none"> • ON: The LED is on. • OFF: The LED is off.
TV Reset		Returns all settings on the TV to their factory defaults.	

- 🔗 Refer to the manual of each solution for details about functions and settings of the solutions such as REACH, HMS, and H.Browser.
- 🔗 REACH (Remote Enhanced Active Control for Hospitality) is a professional, interactive remote controller that lets you deliver TV firmware updates, cloning data, channel mapping changes, REACH contents, and TICKER contents through RF/IP DTV to several hundred hospitality TVs simultaneously. The REACH functions are available only in standalone mode. The REACH Server is sold separately. Refer to the REACH server manual enclosed with the REACH server product for more operating information.

Welcome Message

The welcome message is used to display custom messages on the TV every time TV is turned on by a Guest in Hotel room.

- Welcome message settings are found in the Logo/Message section of the Hotel Option menus.
- Welcome message should be ON in order to display the message on power-on.

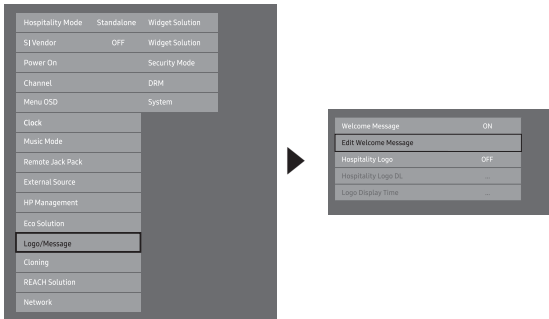

- A welcome message can be up to 25 characters and it can be edited by changing the text in the Hotel Service menu.
- The following is the list of characters supported by Welcome message:
 - ✎ Capital Letters from A-Z, Small Letters from a-z, Blank, Special letters.
- You can make the welcome message and edit it in the Edit Welcome Message.
- Welcome message can be edited by using the navigation,  button on the remote in the Edit Welcome Message.

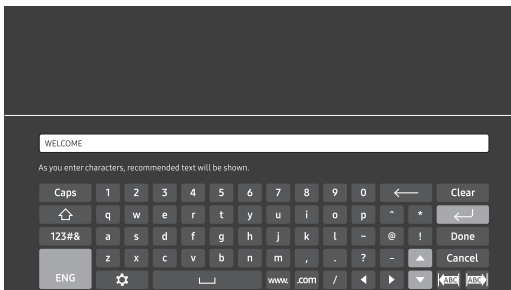

- The Welcome message and hotel logo cannot both be active at the same time.

Hotel Logo

The Hospitality Logo function displays the Hotel's picture image when the TV is initially powered on.

- Hospitality Logo settings are the Logo/Message section of the Hotel Option menus.
- The Logo Download and Logo Display Menu items are enabled when you turn the Hospitality Logo option on.
- If there is a logo image stored in memory and the Hospitality Logo option is on, the Hospitality logo is displayed when the TV is turned on.
- The Hospitality logo is not displayed when the Hospitality option is off, even if its image has been loaded on the TV.

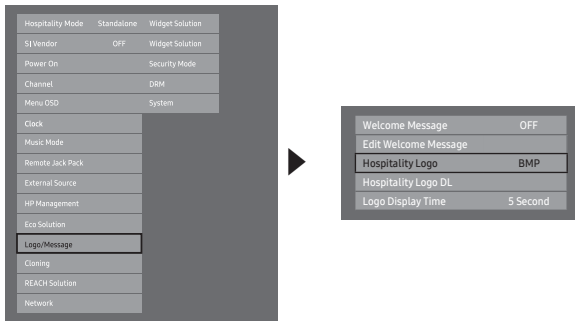

- **Hospitality Logo**
 - This option lets you choose whether the Hospitality Logo image is displayed or not.
 - Initial value is OFF.
 - Can be set to BMP, AVI, or BOTH.
 - When set to BMP, AVI, or BOTH, the Logo Download and Logo Display Time menu items become accessible.
 - The DivX codec is not supported.
- **Hospitality Logo DL**
 - This option lets you download the logo image to the TV's memory from a USB device.
 - "In Progress" message appears while the image is being copied to the TV.
 - A "Completed" message appears when the copy operation finishes successfully.
 - The word "Failed" appears if the copy operation was unsuccessful.
 - No USB appears if no USB device is connected.
 - No file appears if there is no file to copy on the USB device or the file on USB device is the wrong format. If no file appears and there is a logo file on the USB device, check the file format. The file format must be a BMP or AVI.
- **Logo File Format**
 - The TV supports only BMP and AVI format.
 - The file name must be samsung.bmp or samsung.avi.
 - The maximum resolution of the BMP format is 960 x 540.
 - The maximum file size for AVI format is 30MB.
 - The TV does not change the size or scale of the image.

USB Cloning

USB Cloning is used to download user-configured settings (Picture, Sound, Input, Channel, Setup, and Hotel Setup) from one TV set and upload them to other TV sets.

All the user-defined settings from the TV (Master Set) can be copied to the USB device.

✎ After cloning, certain features are applied when the TV is turned on again.

- **Clone TV to USB:** This copies stored data from the TV set to the USB device.

1. Insert a USB drive into the USB port on the rear of the TV.
2. Enter the Interactive menu by pressing buttons in order.
 - MUTE → 1 → 1 → 9 → ENTER
3. Press the ▲ or ▼ button to select "Clone TV to USB", then press the ENTER button.

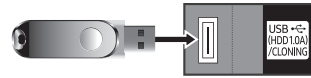

4. You can verify USB cloning behavior.
 - **In Progress:** during copying data to USB.
 - **Completed:** copy was finished successfully.
 - **Failed:** copy was not finished successfully.
 - **No USB:** USB is not connected.

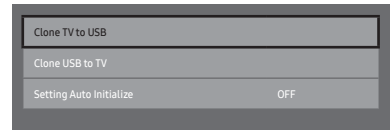

✎ The clone folder will be labeled T-KTMDEUCB.

- **Clone USB to TV:** This to downloads the stored data in the USB device to TV set.

1. Insert a USB drive into the USB port on the rear of the TV.
2. Enter the Interactive menu by pressing buttons in order: MUTE → 1 → 1 → 9 → ENTER
3. Press the ▲ or ▼ button to select "Clone USB to TV", then press the ENTER button.
4. When the message "Copy data from USB to TV Set. All of the TV Setting values are changed" is displayed, and then select "OK".



5. You can Make sure USB cloning behavior.

- **In Progress:** copying data to TV.
- **Completed:** copy finished successfully.
- **Failed:** copy did not finish successfully.
- **No USB:** USB is not connected.
- **No File:** There is no file to copy on the USB device. If you get a No File message, check the folder on your USB device. The folder name should be T-KTMDEUCB.

✎ Activate copying from USB to TV by pressing ENTER key for 5 seconds.

✎ The Hotel TV product family does not support the CLONE function between models that supports the satellite / T2 operation and models that do not.

For fast, instant cloning during installation, insert a USB drive with master settings from the first TV and press the Enter key for 5 seconds.

Pre-condition for cloning (check point)

- Cloning should be done between same model.
- Before cloning, all displays should be updated at the latest version (same version).

Settings Cloned in the Hotel Menu

 The menu item does not support depending on the models.

Menu Item	Sub Item	Cloned or not	
Hospitality Mode	Standalone / Interactive Default : Standalone	Yes	
SI Vendor	Interactive mode : Samsung / 2M / Locatel / VDA / VDA-S / Acentic / Sustinere / Quadriga / ETV / IBahn / Magilink / Otrum / Siemens / Amino / MDC / Enseio Standalone mode : OFF / Movielink / Swisscom / Smoovie / SSCP	Yes	
Power On	Power On Channel	User Defined / Last Saved	Yes
	Power On Channel Num	***	Yes
	Power On Channel Type	ATV / DTV / CATV / CDTV	Yes
	Power On Volume	User Defined / Last Saved	Yes
	Power On Volume Num	0~100	Yes
	Min Volume	0~100	Yes
	Max Volume	0~100	Yes
	Power On Source	TV / HDMI1 / HDMI2 / AV / Last Saved	Yes
	Power On Option	Power On / Standby / Last Option	Yes
Channel	Channel Setup	—	No
	Channel Editor	—	No
	Mixed Channel Map	On / Off	Yes
	Dynamic SI	On / Off	Yes
	Channel Rescan Message	On / Off	Yes
	Pan Euro MHEG	On / Off	Yes
	MyChannel	On / Off	Yes
	Genre Editor	—	Yes
	Subtitle Auto On	On / Off	Yes
	TTX Widescreen Mode	On/Off	Yes
Menu OSD	Picture Menu Lock	On / Off	Yes
	Menu Display	On / Off	Yes
	Tools Display	On / Off	Yes
	Channel Menu Display	On / Off	Yes
	Panel Button Lock	Unlock / Lock / OnlyPower / Menu / Source	Yes
	Home Menu Display	On / Off	Yes
	Home Menu Editor	—	Yes
Home Menu Auto Start	—	Yes	

	Menu Item	Sub Item	Cloned or not
Clock	Clock Type	Standalone mode: Off / SW Clock	Yes
	Local Time	Manual / TTX / Time Channel	Yes
	Timer Type	WakeUp / OnOff	Yes
Music Mode	Music Mode AV	On / Off	Yes
	Music Mode Backlight	On / Off	Yes
Remote Jack Pack	Priority AV	1~2	Yes
	Priority HDMI	1~2	Yes
	AV Option	AV	Yes
	HDMI Option	HDMI1 / HDMI2 / HDMI3	Yes
External Source	USB Pop-up Screen	Default / Automatic / Disable	Yes
	External Source Banner	On / Off	Yes
	Auto Source	On / Off	Yes
	Anynet+Return Source	Power On Src / Last Source / TV / HDMI1 / HDMI2 / AV	Yes
HP Management	HP Mode	On / Off	Yes
	Default HP Volume	0~100	Yes
	Main Speaker	On / Off	Yes
Eco Solution	Energy Saving	Off / Low / Medium / High	Yes
Logo / Message	Welcome Message	On / Off	Yes
	Edit Welcome Message	—	Yes
	Hospitality Logo	Off / BMP / AVI / BOTH	Yes
	Hospitality Logo DL	—	Yes
	Logo Display Time	3 second / 5 second / 7 second	Yes
Cloning	Clone TV to USB	—	No
	Clone USB to TV	—	No
	Setting Auto Intialize	On / Off	Yes
REACH Solution	REACH	On / Off	Yes
	REACH IP Mode	On / Off	Yes
	Server IP Setting	—	Yes
	REACH Channel	***	Yes
	REACH Update Time	OFF / 1hour / 2hour / 12:00 am / 2:00 am / 12:00 pm / 2:00 pm	Yes
	REACH Update Immediate	On / Off	Yes
	Group ID	ALL, 1 - 511	No
	Room Number	—	No
	REACH Config Version	—	No

Menu Item		Sub Item	Cloned or not
Network	Network Setup		—
	SmartHub Model Setting		—
	SmartHub Setting		—
	Service Discovery		On / Off
Widget Solution	Widget Mode		On / Off
	Solution Type		Vender Server/ SINC Server
	Server URL Setting		—
	License Server IP Setting		—
	IPTV Mode		On / Off
	Room Num Setting		—
	HMS HalfTicker Display		—
Virtual Standby	Virtual Standby Mode		On / Off
	Reboot Time		—
Security Mode	FactoryLock		On / Off
	Password Popup		On / Off
	Password Input		—
	Password Setting		—
	Password Reset		—
	Security Mode		On / Off
	USB		Enable / Disable
	HDMI		Enable / Disable
DRM	TTX Security		Enable / Disable
	DRM Mode		PI Model - OFF/LYNK DRM/Proldiom/LYNK DRM, PI Non PI Model - OFF/LYNK DRM
System	Self Diagnosis for TV		—
	Self Diagnosis for HTV	STB SI Vendor Setting	Si Name Ok / Failure
		RTC	Ok / Failure
	SW Update		-
	Service Pattern		On / Off
	Sound Bar Out		On / Off
	Contact Samsung		—
	Standby LED		On / Off
	TV Reset		—

Setting Auto Initialize

When you clone settings from one TV to another, you clone both the guest side menu and hotel side menu settings: (Picture, Sound, Input, Channel, Setup, and Hotel Setup). This lets you set nearly all of the menu values on your hospitality TVs to the same, standard settings. If you allow guests access to the guest side menus, for example the Picture menu, they can change the settings in those menus so they are no longer standard. If you set the Setting Auto Initialize function to on, the TV automatically restores (initializes) any guest-side menu values to the cloned, standard values when the TV is turned off and then turned on again. Note that Setting Auto Initialize works on cloned guest side menu values only. Settings which have not been cloned are ignored.

The table below lists the settings that are restored to their cloned values when you set the Setting Auto Initialize function to on.

 The menu item does not support depending on the models.

Menu Item		
Picture	Picture Mode	Backlight
		Contrast
		Brightness
		Sharpness
		Colour
		Tint (G/R)
	Apply Picture Mode	
	Picture Size	Picture Size
		Zoom/Position
		4:3 Screen Size
	PIP	
	Advanced Settings	Dynamic Contrast
		Black Tone
		Flesh Tone
		RGB Only Mode
		Colour Space
		White Balance
		Gamma
	Picture Options	Motion Lighting
		Colour Tone
Digital Clean View		
MPEG Noise Filter		
HDMI Black Level		
Picture Options	Film Mode	
	LED Clear Motion	
	Picture Off	
	Reset Picture	
	Sound Mode	
Sound Effect	Equaliser	
Speaker Settings		
Sound	Additional Settings	DTV Audio Level
		Audio Format
		Audio Delay
		Dolby Digital Comp
		Auto Volume
Reset Sound		

Menu Item		
System	Accessibility	Voice Guide
		Audio Description
		Subtitle
		Menu Transparency
		High Contrast
		Enlarge
	Sports Mode	
	Menu Language	
	Device Manager	Keyboard Settings
		Mouse Settings
	Time	Clock
		Sleep Timer
		Wake-up Timer
	Eco Solution	Energy Saving
		No Signal Power Off
		Auto Power Off
	Smart Security	Smart Security
		Scan
		Isolated List
		Allowed List
		Settings
	Auto Protection Time	
	Change PIN	
	General	Game Mode
		Sound Feedback
		Boot Logo
	Anynet+ (HDMI-CEC)	Anynet+ (HDMI-CEC)
Auto Turn Off		
Search for Devices		
DivX® Video On Demand		

Plug & Play

Hotel Plug & Play automatically performs Hotel mode selection, country setup, clock setup and picture mode setup. Also, if you select TV Reset from the System section of the Hotel Option menus, the setup is run automatically.

- Hotel Plug & Play is available only one time when power is first turned on.
- This is available after first setting up the TV and transferring Clone TV data to a USB drive.
- To use next TV, you only need to exit Hotel Plug & Play, connect the USB, then Clone the USB to TV.
- Depending on model and region, some menus may not exist.

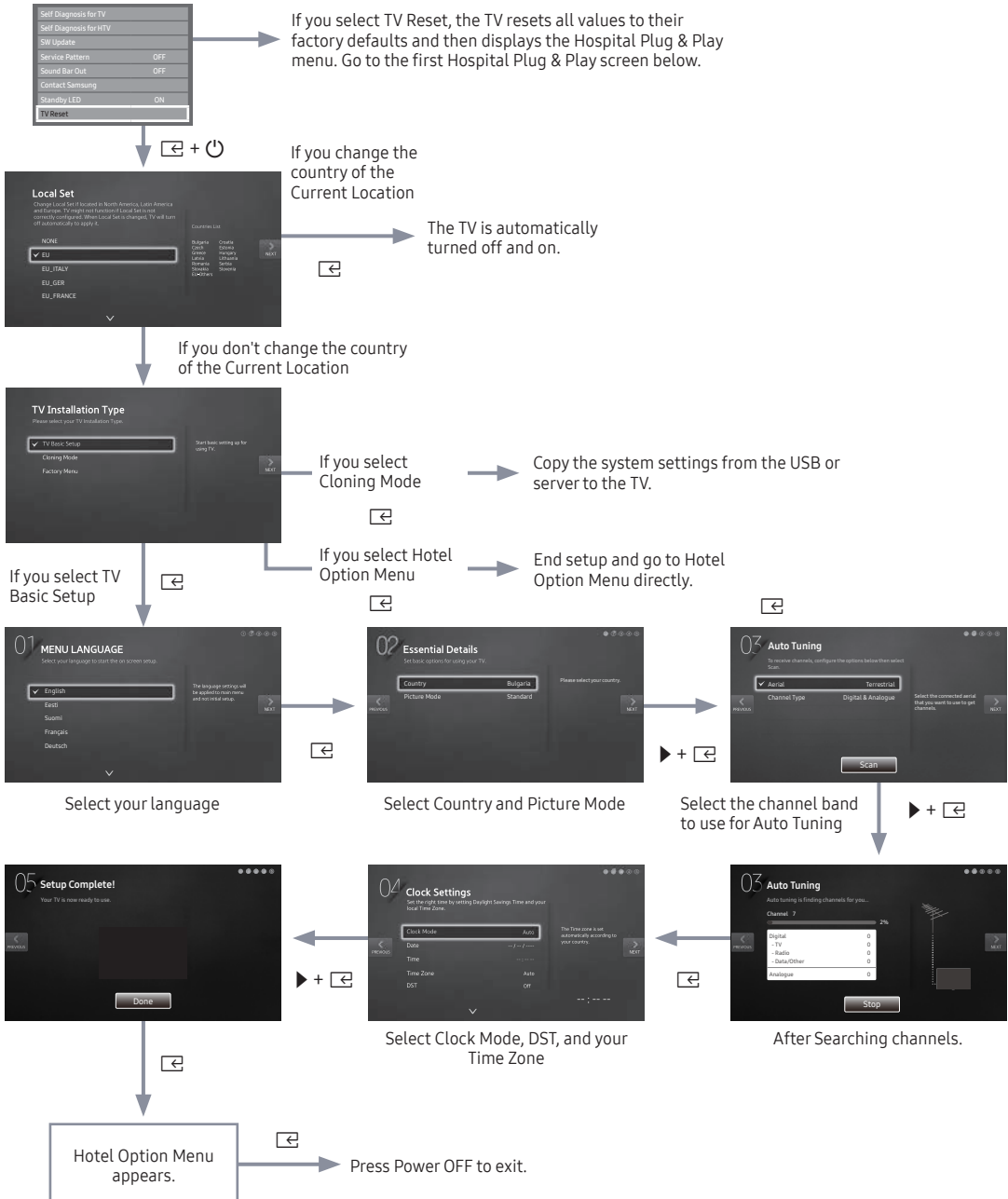

- **LocalSet**
 - Initially highlighted: EU
 - If you press the Enter key after selecting Change, you can change the country.
 - If the country is changed, the TV automatically turns off and on.
 - If you select the incorrect country, execute TV Reset again after entering the System section of the Hotel Menu.
- **Menu Language OSD**
 - If you select Basic TV Setup from the "TV Installation Type" OSD, the "Menu Language" OSD appears.
 - Initially highlighted: English
 - If you press the Enter key, the "Picture Mode" OSD appears
- **Picture Mode OSD**
 - Initially highlighted: Standard
 - The TV displays the Picture Mode OSD where you can choose the Dynamic or a Standard Picture mode.
- **Auto Program OSD**
 - If you press the Enter key, the TV automatically searches for channels.
- **Set Clock Mode, DST(Daylight saving time), and Time Zone OSD**
 - Initially highlighted: Clock Mode : Auto, DST : Off, Time Zone : Eastern
 - If the TV will be tuned to digital broadcast channels, and these channels transmit date and time information, set the Clock Mode to Auto. The TV will set the date and time automatically.
 - If the TV will not be tuned to digital broadcast channels, set the Clock Mode to Manual, and then set the date and time on the TV manually.
 - Set DST On or Off to apply or not apply daylight saving time to the TV.
 - Select your time zone on the map that appears.

Multi Code Remocon

Multi Code Remocon is a special transmitter which is designed to control each TV with one remote.

This is useful where there is more than one TV in a location, such as in a hospital. The set ID number is displayed in the source osd. It is possible to support up to 9 different remote key transmissions for multiple codes.

Each TV has an initial code of "0".

- The ID code can be set and reset in Analogue TV mode or PC mode. (not available in TTX channel or DTV channel.
- ID code can be from 0 to 9.
- Press the MUTE button and the RETURN button simultaneously for more than 7 seconds and then select the number button to set the code.
- Set ID OSD appears.
- The following words appear: "Remote control code is set to X. If you want to change the Remote control code, enter the chosen digit." X is the digit number.
 - ✎ This OSD displays until Exit is pressed.



Remote control code is set to 0. If you want to change the Remote control code, enter the chosen digit.

- For example, TV and Remote will be set to ID code #1 if the user presses #1.
- The following words appear: "Remote control code is changed to 1" At this point, the TV can be controlled only by the remote with the same ID code as the TV.
- TV, the following words will be displayed. "TV ID x"(x is the TV's ID)
- To reset the ID code, press the MUTE button and the EXIT button simultaneously for more than 7 seconds. When you stop pressing the buttons, the ID code for both the TV and Remote are reset to "0". "Remote control code is set to 0." appears.

Channel Bank Editor (Smovie TV Only)

Channel Bank Editor edits channels, with 3 different Bank Options.
Depending on the Bank card, there are specific channels Hotel customers can enjoy.

Setting the Channel Bank Editor under Stand-alone Mode

1. Enter the Hotel Standalone menu by "MUTE → 1 → 1 → 9 → ENTER☑"
2. Please select SI vendor : "Smovie"
3. find the new menu option, "Channel Bank Editor"
4. Enter the "Channel Bank Editor"

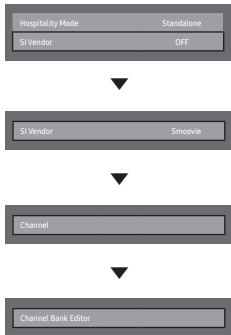

<Depending on model and region, some menu items may not exist>

5. Edit the channel bank like below example.
 - a. BANK1 (Free channel): Select the channel that will be used when remote doesn't have any card.
 - b. BANK2 (Family Card - Green): Select the channel that will be used when remote has a GREEN CARD.
 - c. BANK3 (Adult Card - Red): Select the channel that will be used when remote has a RED CARD.

Channel Bank Edit

Registered	Bank1 (4)	Bank2 (6)	Bank3 (36)
1 futech	<input type="checkbox"/>	<input type="checkbox"/>	<input checked="" type="checkbox"/>
2 BBC1	<input checked="" type="checkbox"/>	<input checked="" type="checkbox"/>	<input checked="" type="checkbox"/>
3 24ore.tv	<input checked="" type="checkbox"/>	<input checked="" type="checkbox"/>	<input checked="" type="checkbox"/>
4 C3	<input type="checkbox"/>	<input checked="" type="checkbox"/>	<input checked="" type="checkbox"/>
5 BBC World	<input type="checkbox"/>	<input checked="" type="checkbox"/>	<input checked="" type="checkbox"/>
6 C5	<input type="checkbox"/>	<input checked="" type="checkbox"/>	<input checked="" type="checkbox"/>
7 Coming Soon	<input type="checkbox"/>	<input checked="" type="checkbox"/>	<input checked="" type="checkbox"/>
8 S2	<input type="checkbox"/>	<input type="checkbox"/>	<input checked="" type="checkbox"/>
9 S2	<input type="checkbox"/>	<input type="checkbox"/>	<input checked="" type="checkbox"/>

References of using SMOOVIE Remote Controller

1. If you select SMOOVIE as the SI Vendor, you should use the SMOOVIE Remote Controller.
2. With the Numeric keys of the remote controller, users can select only the BANK1 channel. To change the channel using the Green or Red Card, please use channel up/down keys.
3. For the Channel guide or the Channel list, users can see only BANK1 channel list.

Channel Editor

Channel Editor edits channel number and name.

Use Channel Editor to sort the channels as user-desired channel numbers.



<Depending on model and region, some menu items may not exist>

Simple Steps for Editor under Stand-alone Mode

Step	Broad Outline
1	Operate 'Channel Setup' in Hotel Option Menu
2	Enter 'Channel Editor' in Hotel Option Menu
3	Compile a table related to the final channel lists you want to have
4	Rearrange channels with the TOOLS Button based on the table you compiled
5	Press the EXIT or RETURN Button to exit.

<please refer to the following details>







Smovie On sequence

Step	Smovie TV used (Air / Cable)	
	Mixed Channel Map On (Air and Cable both used)	Only Air or Cable used
1	Do the P&P, except channel store ☞ If P&P already done, proceed from step 3 after enter Hotel Option menu. (Hotel Option menu: MUTE → 1 → 1 → 9 → ENTER).	Do the P&P all (Air or Cable auto tune) ☞ If P&P already done, proceed from step 3 after enter Hotel Option menu. (Hotel Option menu: MUTE → 1 → 1 → 9 → ENTER).
2	After P&P TV shows hotel menu	After P&P TV will show hotel menu
3	Setup Mixed Channel Map On	
4	Make TV power off & on	Select smovie TV in Hotel menu
5	Enter Hotel menu	Select Channel Setup (can be skipped)
6	Select smovie TV in Hotel menu	Select "Terrestrial" or "Cable" to auto tune (can be skipped)
7	Select Channel Setup	Setup Channel Bank Editor
8	Select "Terrestrial + Cable" to auto tune	After power off & on, user can use TV
9	Setup Channel Bank Editor	
10	After power off & on, user can use TV	

Channel List

You can view channel information, **All**, **TV**, **Radio**, **Data/Other**, **Analogue** or **Favourites 1 - Favourites 5**.

 When you press the CH.LIST button on the remote control, **Channel List** screen displays immediately.

- **All**: Shows all currently available channels.
 - **TV**: Shows all currently available TV channels.
 - **Radio**: Shows all currently available radio channels.
 - **Data/Other**: Shows all currently available MHP or other channels.
 - **Analogue**: Shows all currently available analogue channels.
 - **Favourites 1 - Favourites 5**: Shows all favourite channels.
-  If you want to view added favourite channels press the CH.LIST button and use the ◀ or ▶ button to move between **Favourites 1 - Favourites 5**.
-  Using the control buttons with the **Channel List**.
-  (**Tools**): Displays the option menu.
 -  (**Channel**): Move to the **All**, **TV**, **Radio**, **Data/Other**, **Analogue** or **Favourites 1 - Favourites 5**.
 - When you select the **Programme View** in  (**Tools**) menu, you can move to other channels using ◀ or ▶ button.
 -  (**Watch / Information**): Watches the channel you selected. / Displays details of the selected programme.
 -  (**Page**): Move to the next or previous page.

How to use Schedule Viewing in Channel List

(digital channels only)

When you set the **Schedule Viewing** in **Channel List**, you can only set the programme in **Programme View**.

1. Press the CH.LIST button, then select a desired digital channel.
 2. Press the TOOLS button, and then select **Programme View**. The programme list for that channel appears.
 3. Press the ▲ / ▼ buttons to select the desired programme, then press the ENTER (Information) or INFO button.
 4. Select **Schedule Viewing**, then press the ENTER button when done.
- 🔑 If you want to cancel **Schedule Viewing**, follow steps 1 through 3. Select **Cancel schedule**.

Using Option Menu **TOOLS**







Set each channel using the **Channel List** menu options (**Programme View**, **Edit Favourites**, **Lock/Unlock**, **Edit Channel Name**, **Edit Channel Number**, **Delete**, **Information**, **Sort**, **Edit Mode**).

Option menu items may differ depending on the channel status.

1. Select a channel and press the TOOLS button.
2. Select a function and change its settings.
 - **Programme View**: Displays the programme when a digital channel is selected.
 - **Edit Favourites**: Set channels you watch frequently as favourites. Add or delete the selected channel in **Favourites 1 - Favourites 5**.
1. Select the **Edit Favourites**, then press the ENTER button.
2. Press the ENTER button to select **Favourites 1 - Favourites 5**, then press the OK button.
 - 🔑 One favourite channel can be added to several favourites among **Favourites 1 - Favourites 5**.
 - **Lock/Unlock**: Lock a channel so that the channel cannot be selected and viewed.
 - 🔑 This function is available only when the **Channel Lock** is set to **On**.
 - 🔑 The PIN input screen appears. Enter your 4-digit PIN. Change the PIN using the **Change PIN** option.
 - **Edit Channel Name** (analogue channels only): Assign your own channel name.
 - **Edit Channel Number** (digital channels only): Edit the number by pressing the number buttons.
 - 🔑 Some areas may not be able to support **Edit Channel Name** and **Edit Channel Number**.
 - **Delete**: You can delete a channel to display the channels you want.
 - **Information**: Displays details of the selected programme.
 - **Sort**: Changes the list ordered by channel number or channel name.
 - **Edit Mode**: Select desired channels and edit them.

Using Option Menu

Set each channel using the menu options (**Edit Favourites**, **Lock/Unlock**, **Delete**, **Deselect**, **Select All**).

1. Press the **TOOLS** button in **Channel List** screen, then select the **Edit Mode**. A check box appears to the left of the channel.
2. Press the **▲/▼** buttons to select the desired channel, then press the **ENTER**  button. The (✓) mark indicates the channel you've selected.
 -  You can select more than one channel.
 -  Press the **ENTER**  again to deselect the channel.
3. Press the **TOOLS** button, then select a function and change its settings.
 - **Edit Favourites**: Set the selected channels you watch frequently as favourites.
 -  The **Edit Favourites** screen has five groups (**Favourites 1**, **Favourites 2**, etc.). You can add a favourite channel to any one of the groups. Press the **▲/▼** buttons to select a group.
 - **Lock/Unlock**: Lock a channel so that the channel cannot be selected and viewed.
 -  This function is available only when the **Channel Lock** is set to **On**.
 -  The PIN input screen appears. Enter your 4-digit PIN. Change the PIN using the **Change PIN** option.
 - **Delete**: You can delete a channel to display the channels you want.
 - **Deselect**: Deselect the selected channels.
 - **Select All**: Select all the channels in the channel list.

My Channel

Determines the language and genre for the channels provided by the hotel, and if the user selects a language and genre, shows the corresponding channels.

- You must select the language first, or you can not set a genre.
- If you select the genre without adding any channels, the channel list displays all of the available channels.
- My Channel works in Standalone mode only.
- SI Vendor in Standalone mode: This does not work if Smoovie is selected.
- My Channel is in Hotel Option Menu > Channel and can be set to on or off.
- My Channel only works when it is set to on.

Channel Composition [Genre Mode]

Standard	Category	Ch. Mode	Antenna Mode Activation	Description
Hotel	Genre	All (Default)	0	Provide genre channel mode by each language that master has managed in factory mode.
		News	0	
		Radio	0	
		Entertainment	0	
		Sport	0	
		Hotel	0	

The screenshot shows the 'My Channel' configuration interface. It features two main sections: 'Language' and 'Genre'. The 'Language' section includes a list of languages with checkboxes: All (checked), Afrikaans, Albanian, Arabic, Bosnia, Bulgarian (highlighted), and Cambodia. The 'Genre' section includes a list of genres with checkboxes: All (checked), News, Radio, Entertainment, Sports, and Hotel. A dropdown arrow is visible at the bottom of the Language section. Numbered callouts (1-6) point to various UI elements: 1 points to the top-left corner, 2 to the title 'My Channel', 3 to the Language header, 4 to the Genre header, 5 to the Bulgarian checkbox, and 6 to the dropdown arrow.

* For the number of items to be displayed in the list, refer to the Elements.

Key Guide

Button	Action	Nav. Help
BLUE	Returns to the screen. (Genre setup: Last Language & Genre)	Keep Previous
Enter	Selects an item.	Select
Ch. Up/Down	Move the highlight by page.	(No Guide)
UP/DOWN	Navigates the each language, genre list. (in a circular manner.)	Move
RIGHT	Selects the highlighted item, and then move the highlight to Genre section.	
RETURN	Returns to the screen. (Genre setup: Last Language & Genre)	(No Guide)
EXIT	Returns to the screen. (Genre setup: Last Language & Genre)	(No Guide)

NOTE

- This section describes the layout of the Front UI that appears when the TV is turned on. (Hotel Option Menu > Channel > Mychannel : On)
- The genre is a sub-list for each language.
- The broadcast screen that was being displayed the last memorial channel.
- If user want to keep the previous language & genre channel map, press the 'BLUE', RETURN, and EXIT remote-control key to close the Front UI.

ETC.

- Default Highlight : Last Memory items (Language, Genre)

Elements

No	Name	Description
①	Background Screen	Displays the last memorized channel that appears when TV is turned on.
②	Function Title	This is name of the function.
③	Language Items	The item for the language list is displayed. Displays the last selected language.
④	Genre Items	The item for the genre list is displayed. Displays available genre items by each language that master managed in factory mode. (always provide 'All' item) Displays the last selected genre.
⑤	Highlight	If the item title is too long to be displayed within the area, Auto Text Sliding works.
⑥	Indicator	This is displayed when there is a previous or next page.

Highlight Interaction [Language Items]

- This page is only to indicate possible interactions. It may not be exactly identical to actual screens.

NOTE

- Users can navigate the items in each language & genre list by pressing the up or down remote control keys.
- Circular navigation is supported.

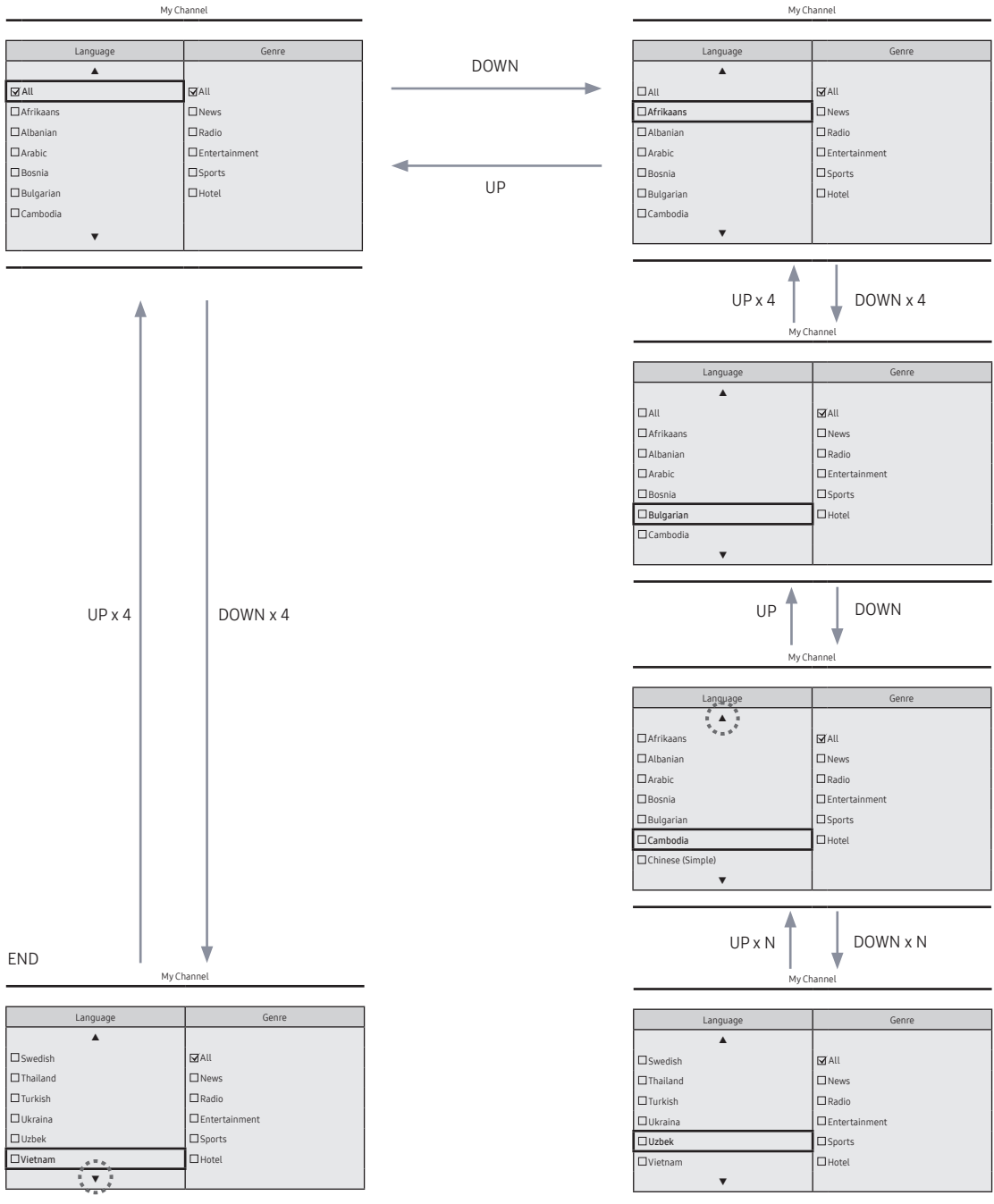

Highlight Interaction [Genre Items]

- This page is only to indicate possible interactions. It may not be exactly identical to actual screens.

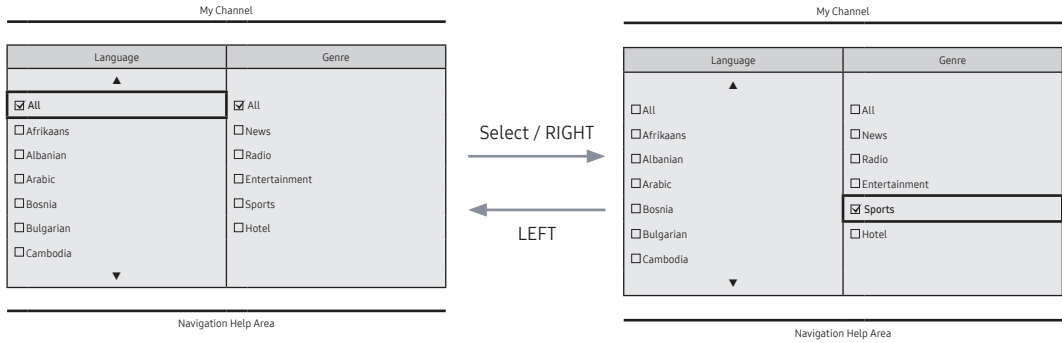

- The current selection of the language is high-lighted.

- Default High-light: The current selection of the genre.

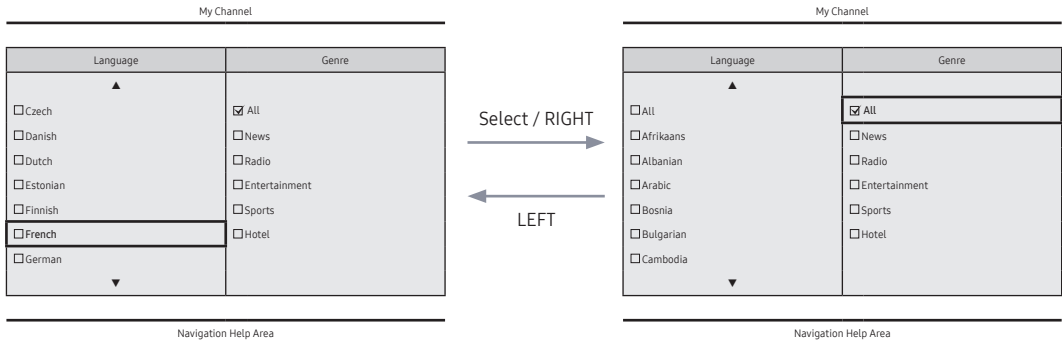

- Default Highlight : All

Mode Change Interaction (1/3)

- This page is only to indicate possible interactions. It may not be exactly identical to actual screens.

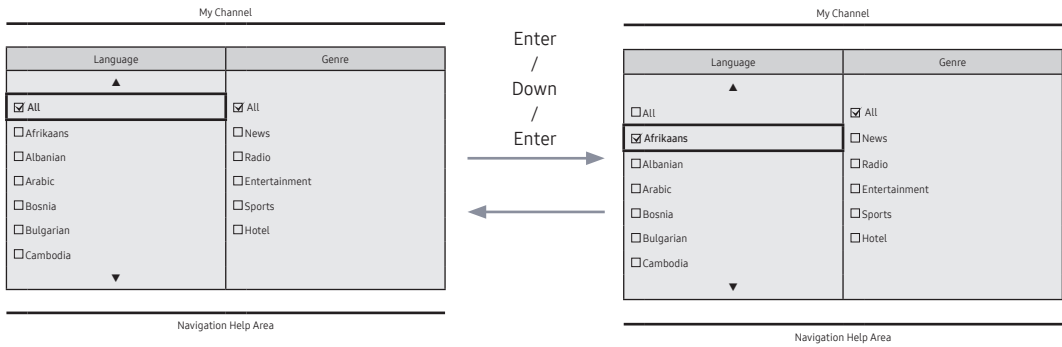

- Current Genre Mode : All / All

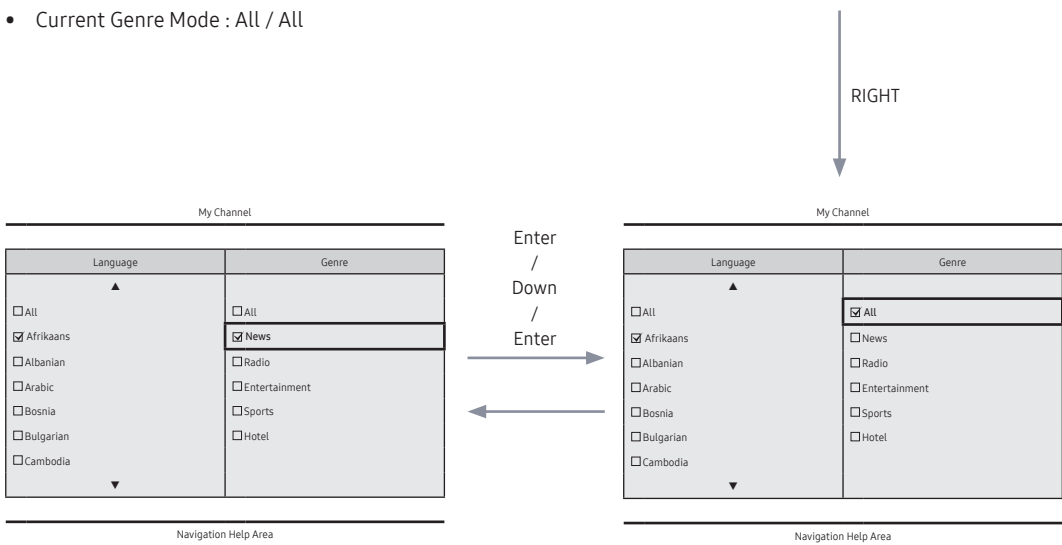

- If the language is selected, highlight moves to genre menu automatically.

Save

Model Change Interaction (2/3)

- This page is only to indicate possible interactions. It may not be exactly identical to actual screens.



- The genre mode change complete message is displayed.
- Timeout(5 sec.)

OK / Return or Timeout

Current Status : Afrikaans / News

Mode Change Interaction (3/3)

- This page is only to indicate possible interactions. It may not be exactly identical to actual screens.

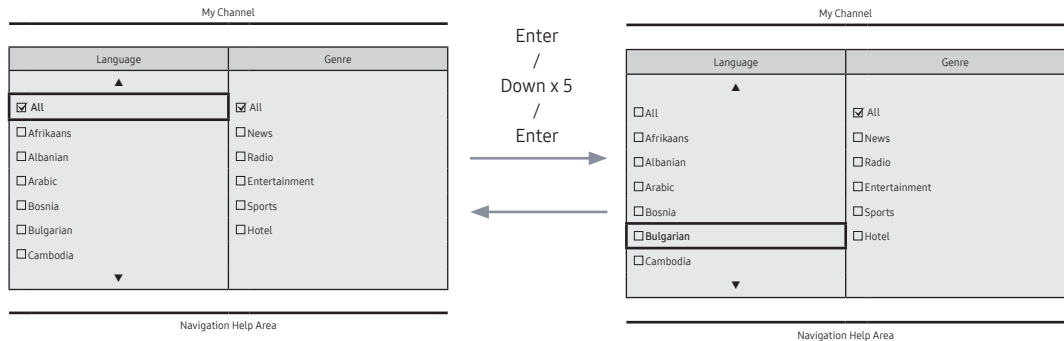

- Current Genre Mode : All / All

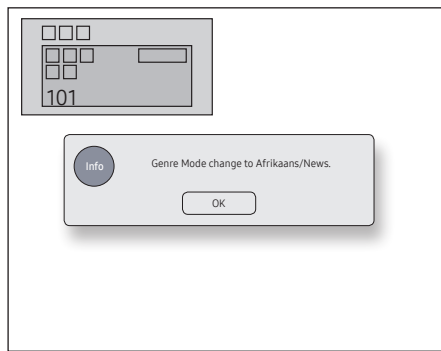
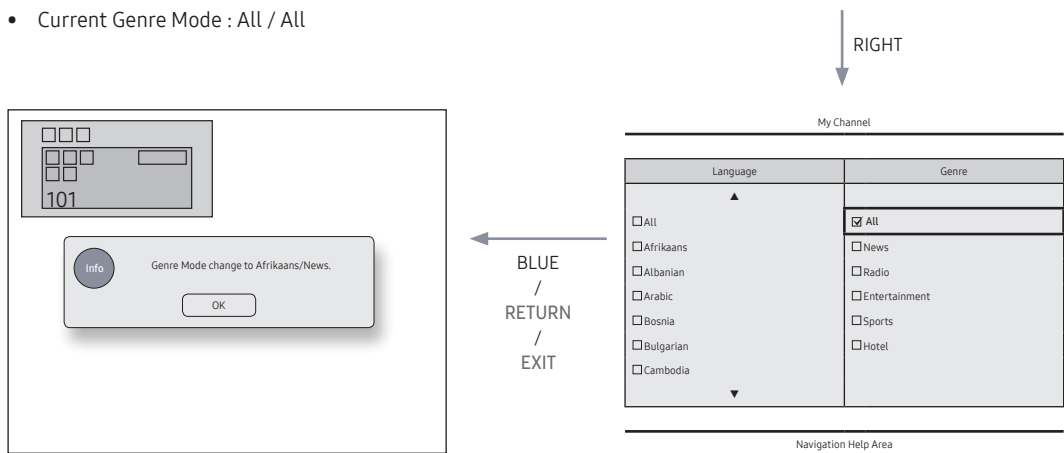

Select
/
RETURN
/
Timeout

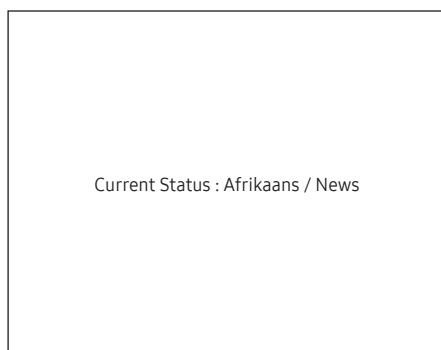

- Pressing the left key from the genre to language, menu highlights an existing selected language item.

Power On Scenario [Last Memory]

- This page is only to indicate possible interactions. It may not be exactly identical to actual screens.

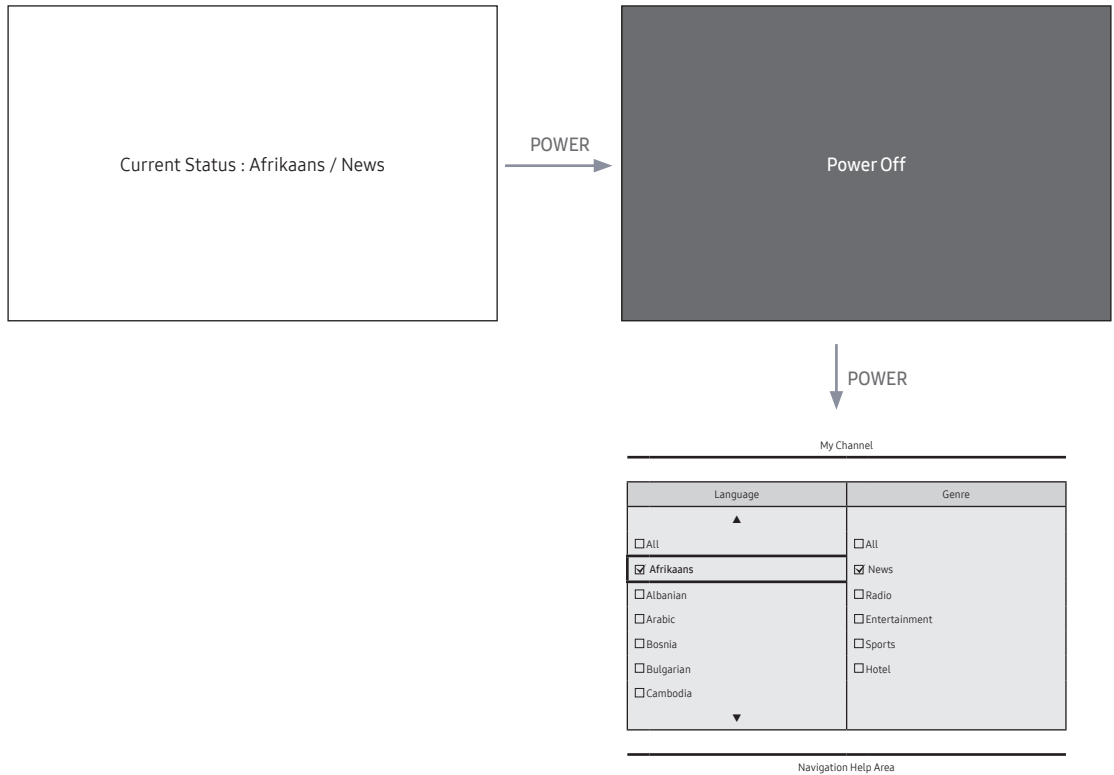

- Current Genre Mode : Afrikaans / News

Genre Editor: This configures the genres of each of the hotel TV channels.

- This can be used through the Hotel Menu (Factory).
- Supported genres include News, Radio, Entertainment, Sports and Hotel.
- More than one genre can be selected for each channel at the same time.

Channel Editor (Language Editor): This is the editor that configures the language for each of the hotel TV channels.

- Supported language (47 Language): Afrikaans, Albanian, Arabic, Bosnia, Bulgarian, Cambodia, Chinese, Croatian, Czech, Danish, Dutch, English, Estonian, Finnish, French, German, Greek, Hebrew, Hindi, Hungarian, Indonesian, Italian, Japanese, Kazakhstan, Korean, Latvia, Lithuania, Macedonia, Malaysia, Myanmar, Nepali, Norwegian, Persian, Polish, Portuguese, Rumanian, Russian, Serbian, Slovak, Slovenia, Spanish, Swedish, Thailand, Turkish, Ukraine, Uzbek, Vietnam
- If more than one channel is set to a language, the language is registered as a category and users can view the channels by language.
- More than one language can be set to a channel. If the user selects a category, only the channels corresponding to the language are displayed in the channel list.
- If any channel for which the language is set is selected from the channel list, the Edit language item is added to the Tools. Otherwise, the Add to language item is added to the Tools.
- * If the corresponding function is executed, a language for the selected channel can be set or canceled.
- Front UI provides the screen when the user can select a language or genre when the user turn the power on.

Left Frame Layout

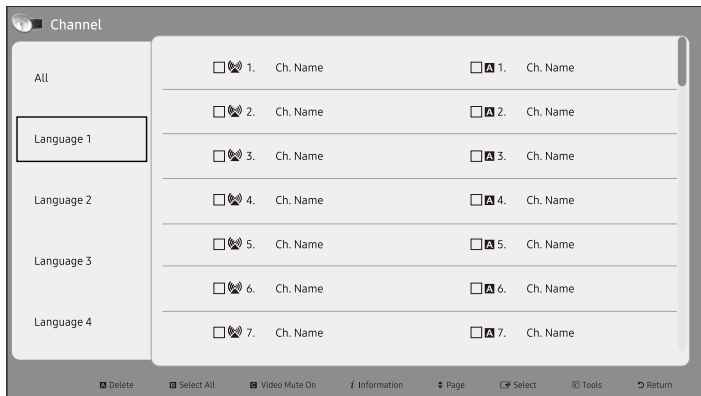

Key Guide

Button	Action	Nav. Help
Enter	Selects or enters the corresponding Channel Browser area.	(No Guide)
RETURN	Selects or enters the corresponding Channel Browser area.	Return
UP/DOWN	Moves the highlight up or down.	(No Guide)
RIGHT	Moves the highlight to the Channel Browser area.	(No Guide)
INFO	Shows the Category Info.	(No Guide)
TOOLS	Shows the utility function menus.	Tools
EXIT	Cancels and returns to the previous step (Factory Mode).	(No Guide)

NOTE

- This is a component of the Left Frame (Language Categories).

ETC.

- Default Highlight: 'The currently selected language'

Elements

No	Name	Description
1		<ul style="list-style-type: none"> • When the user enters this screen, the currently selected default item is highlighted. • The Language Icon + Category Name are provided. (If the highlight is in the Main Frame, only the icon is displayed.) • Moving the highlight <ul style="list-style-type: none"> - Pressing the up or down button moves the highlight. - If the items cannot be displayed on one page, up and down indicators are provided. - Once the highlight is moved to a category, the channel list corresponding to the corresponding category is loaded to the Main Frame.

Left Frame [Language Categories]

Standard	Category	Ch. Mode	Antenna Mode Activation	Description
Hotel	Original Tuned	Registered	0	<ul style="list-style-type: none"> • Lists all the channels registered by the Auto Tune operation. • Provides the list of channels and sources specified in the Registered Channels list. • All Language is the sum of all channels registered to each language. (This is only provided to end users.)
	Language	All Language	0	
		Language 1	0	
		Language 2	0	
			0	

Tools [Registered/Language Categories]



- Hotel Option Menu > Channel > Channel Editor > Tool > Information



- The items are displayed without 'Channel'.
- If the Registered/Language item is highlighted, you can enable the corresponding window by pressing the 'INFO' remote control key.
- All languages are displayed.
- Navigate language items by pressing the up or down key. Indicators are provided.

 NOTE

- This is a definition of the Tools menu in the Left Frame Category.
- Only the Info item for each Register/Language is provided.
- The items are displayed without 'Channel'.

Error Cases

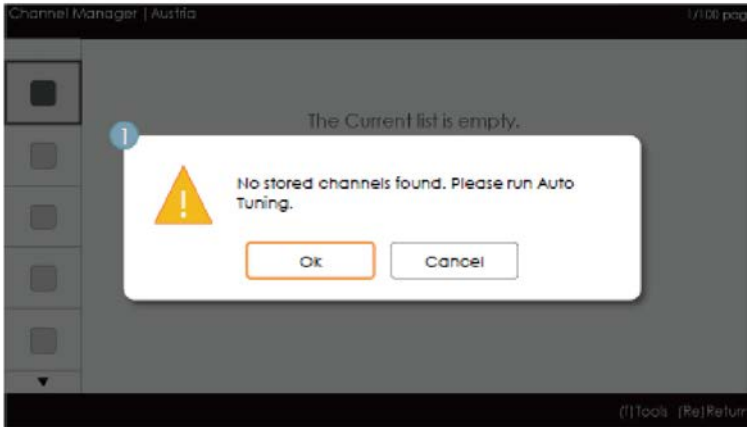

 NOTE

- This is the message for when there are no saved channels in the Registered Channels list.

Elements

No	Name	Description
1	Message	<ul style="list-style-type: none">• When entering the browser, if the Registered channels item is empty, a popup message is displayed which enables users to switch to the Auto Tuning menu.• When both the time and the channel are not configured, and a user enters the Channel Editor, a message that allows the user to switch to the Auto Tuning operation is displayed in the same way as above.

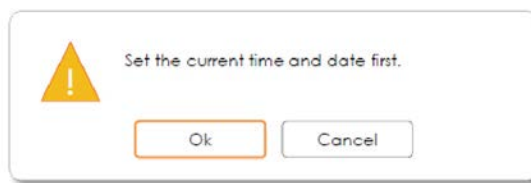

- This is the message when the time is not configured.
 - If the time is not configured, the message is displayed in Factory Mode before entering the Channel Editor.

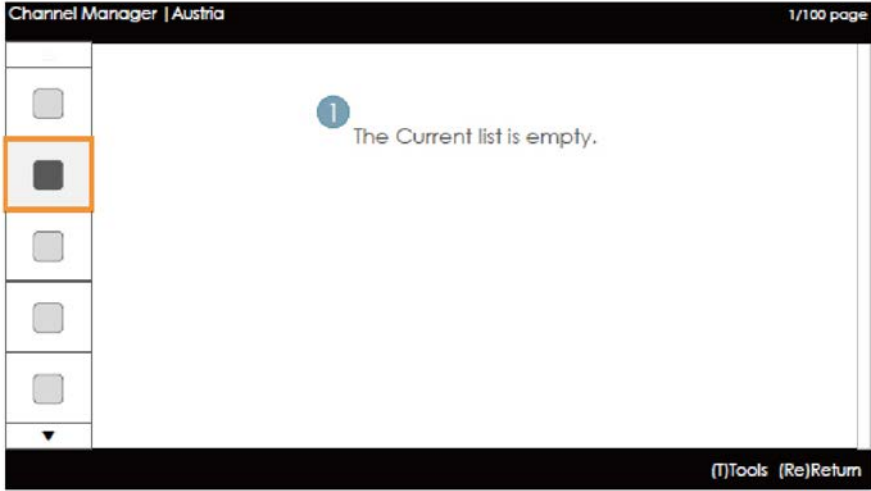

NOTE

- This is the component for when there are no channels registered to the language category.

Elements

No	Name	Description
1		The message is displayed when the currently selected country does not contain any items.

Main Frame [Channel Browser]

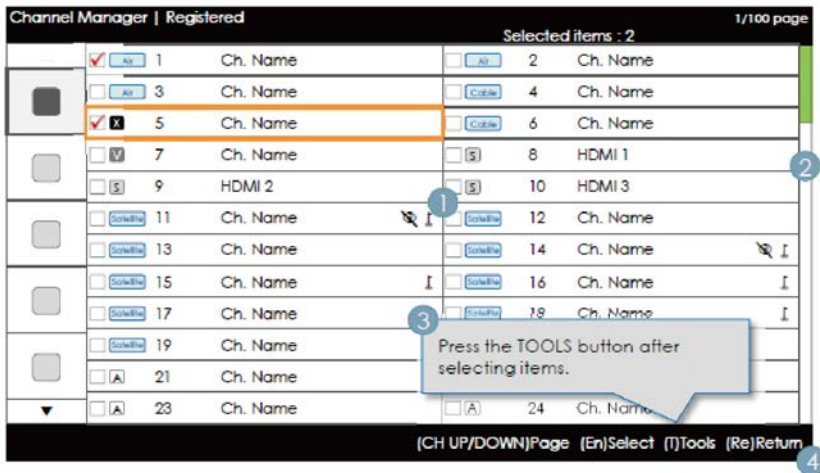

Key Guide

Button	Action	Nav. Help
CH UP/DOWN	Moves the page.	Page
Enter	Selects or enters the corresponding Channel Browser area.	Select
RETURN	Returns to the previous step (Factory Mode).	Return
UP/DOWN	Moves the highlight up or down.	(No Guide)
RIGHT	Moves the highlight to the Channel Browser area.	(No Guide)
INFO	Shows the Category Info.	(No Guide)
TOOLS	Shows the utility function menus.	Tools
EXIT	Cancels and returns to the previous step (Factory Mode).	(No Guide)

NOTE

- This is a component of the Main Frame (Channel Browser).
- The initial highlight is on the channel before entering Factory Mode or the external input.

Elements









No	Name	Description
1	Main Frame	Shows the channel or the source list of the currently selected category.
2	Scroll Bar	Shows the position of the current page amongst the total amount of pages.
3	Navigation Help Area	This is displayed whenever a user enters the Channel Editor. (If a user exits and then reenters the Channel Editor, it is displayed again.) This disappears when the timeout (5 sec.) is reached or a user presses a key.
4	Navigation Help Area	The currently configured country information and the RED buttons are left-aligned. They are displayed and navigated by group graphically. The key guide is right-aligned.

Channel Common Elements [+ Icon-method]

Channel list representation rules

Standard	Item	Construction
ATSC	Digital channels	<ul style="list-style-type: none"> • Check Box + Status Icon + Digital Channel Number + Channel Name • Channel number representation format: ###-### (The channel number is represented by '-')
	Analog channels	<ul style="list-style-type: none"> • Check Box + Analog Icon + Analog Channel Number + Channel Name • Channel number representation format: ### ('-' is not used to represent analog channel numbers.)
DVB (CHEM)	Digital channels	<ul style="list-style-type: none"> • Check Box + Status Icon + Digital Channel Number + Channel Name • Channel number representation format: ### (For the maximum length of the channel number, follow the regional specifications.)
	Analogue channels	<ul style="list-style-type: none"> • Check Box + Analog Icon + Analog Channel Number + Channel Name • Channel number representation format: ### (For the maximum length of the channel number, follow the regional specifications.)

Channel list icon representation rules

Item		Example		Priority
Dynamic SI Icon	Channels deleted by Dynamic SI	<input type="checkbox"/>  NNNNNNNN CH. NAME	<ul style="list-style-type: none"> • Channels that have been deleted by the Dynamic SI but not by the user. 	1
	Channels added by Dynamic SI	<input type="checkbox"/>  NNNNNNNN CH. NAME	<ul style="list-style-type: none"> • Channels that have been added by the Dynamic SI but not by the user. 	2
Analogue Channel Icon		<input type="checkbox"/>  NNNNNNNN CH. NAME (The edited channel name.)	<ul style="list-style-type: none"> • The Analogue channel icon is displayed. 	3
Source Channel Icon		<input type="checkbox"/>  NNNNNNNN CH. NAME	<ul style="list-style-type: none"> • A channel that is an input source. 	4
Antenna Icon	Air	<input type="checkbox"/>  NNNNNNNN CH. NAME	<ul style="list-style-type: none"> • Represents the live channels from the antennas. The Air, Cable or Satellite antenna icons are displayed with the lowest priority. 	5
	Cable	<input type="checkbox"/>  NNNNNNNN CH. NAME		
	Satellite	<input type="checkbox"/>  NNNNNNNN CH. NAME		
Scrambled Channel Icon		NNNNNNNN CH. NAME 	<ul style="list-style-type: none"> • The scrambled channel icon. This appears for the Satellite antenna. 	-
Video Mute		NNNNNNNN CH. NAME 	<ul style="list-style-type: none"> • In a muted channel, the audio and channel information is provided. 	-

Add to Countries / Edit Countries (1/2)

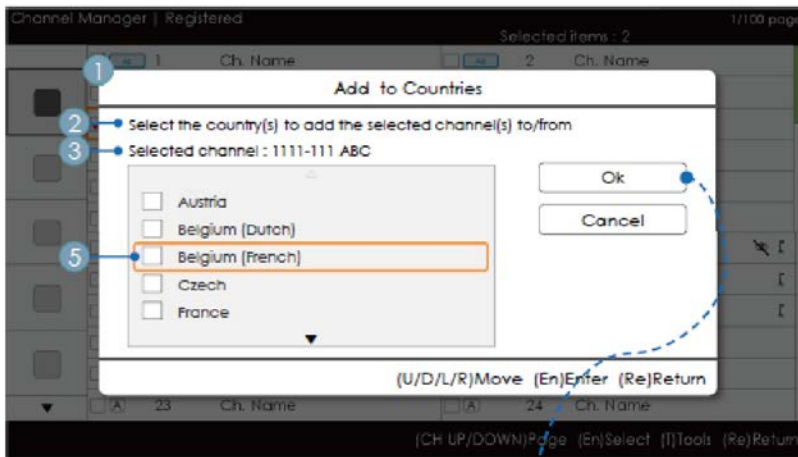

- Hotel Option Menu > Channel > Channel Editor > Tool > Language Edit

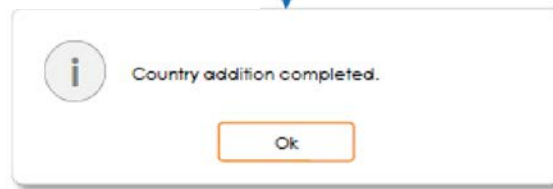

Key Guide

Button	Action	Nav. Help
Enter	Selects the highlighted item.	Select
RETURN	Cancels and returns to the previous screen (Tools).	Return
UP/DOWN	Moves the highlight over country items.	Move
LEFT/RIGHT	Moves the highlight.	Move
INFO	N/R	N/R
TOOLS	Closes the current window and displays the 'Tools' menu.	(No Guide)
EXIT	Cancels and returns to the previous step (Factory Mode).	(No Guide)

NOTE

- This is the definition of Add to Countries.
- The highlighted channel or more than one selected channel is added to the Country category.

ETC.

- Timeout (60 sec)

Elements

No	Name	Description
1	Add to Countries Window	<ul style="list-style-type: none"> If there are no channels that have been registered to the country list in the selected channels, "Add to Countries" is displayed as the title. A check box is displayed depending on whether the country that was selected when entering the screen is registered or not.
2	Guide	
3	Selection Info	<ul style="list-style-type: none"> The serial number or name of the selected channel. <ul style="list-style-type: none"> The channel name is displayed when one channel has been selected: Selected channel: NNNN-NNN ABC The number of selected channels is displayed when more than one channel has been selected: Selected Channels : N
4	Complete Message	<ul style="list-style-type: none"> The message is displayed after the completion of the operation. (This message is always displayed if the OK button is selected.)
5	Selection Mark	<ul style="list-style-type: none"> How to identify the meaning of multiple channel selection marks <input checked="" type="checkbox"/> : When all of the items have been registered. <input type="checkbox"/> : When only part of the items have been registered. <input type="checkbox"/> : When none of the items have been registered.

Add to Countries / Edit Countries (2/2)

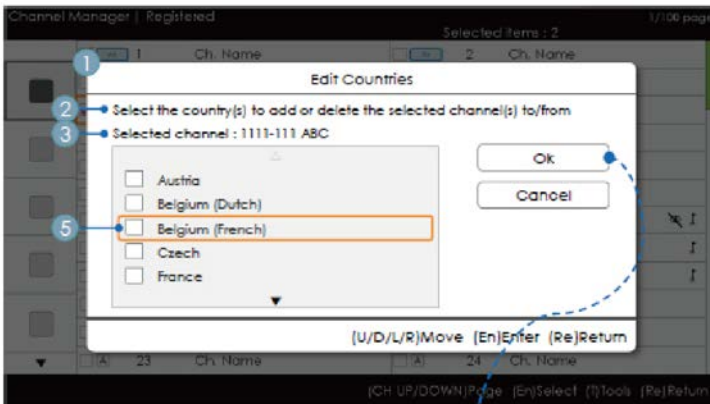

- Hotel Option Menu > Channel > Channel Editor > Tool > Language Edit

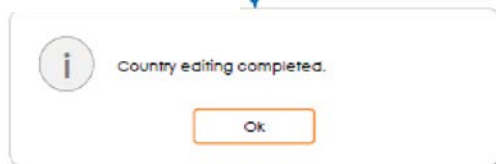

Key Guide

Button	Action	Nav. Help
Enter	Selects the highlighted item.	Select
RETURN	Cancels and returns to the previous screen (Tools).	Return
UP/DOWN	Moves the highlight over country items.	Move
LEFT/RIGHT	Moves the highlight.	Move
INFO	N/R	N/R
TOOLS	Closes the current window and displays the 'Tools' menu.	(No Guide)
EXIT	Cancels and returns to the previous step (Factory Mode).	(No Guide)

NOTE

- This is the definition for Edit Countries.
- The highlighted channel item or more than one selected channel item is added or deleted from the Country category.
- Timeout (60 sec)

Elements

No	Name	Description
1	Add to Countries	<ul style="list-style-type: none"> • If there is a registered channel among the selected channels, Edit Countries is displayed as the title. • A check box is displayed depending on whether the selected country is registered or not.
2	Guide	
3	Complete Message	<ul style="list-style-type: none"> • The message is displayed after the completion of the operation. (This message is always displayed if the OK button is selected.)

Edit Channel Number [Swap Type]

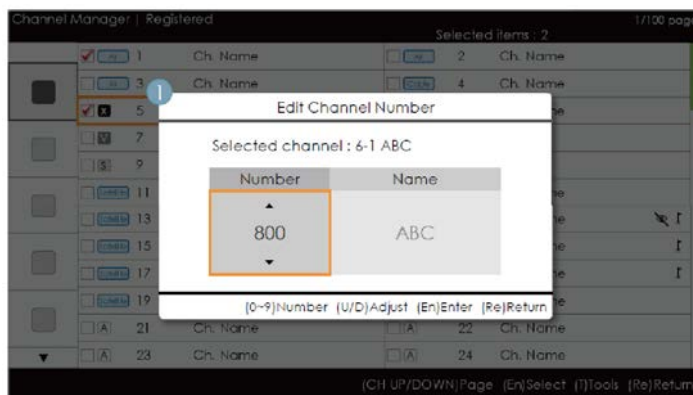

- Hotel Option Menu > Channel > Channel Editor > Tool > Edit Channel Number

Key Guide

Button	Action	Nav. Help
Enter	Applies the changes and closes the window.	Select
RETURN	Cancels and returns to the previous screen (Tools).	Return
▲/▼	Changes the channel number of the selected channel.	Adjust
0~9	Enters a digit.	Number
INFO	N/R	N/R
TOOLS	Closes the current window and displays the 'Tools' menu.	(No Guide)
EXIT	Cancels and returns to the previous step (Factory Mode).	(No Guide)

NOTE

- This is the function that changes the channel number. (Swap Type)
- Channel numbers can be changed in all the channel lists and changes are applied to all the channels.
- If the new channel number has not been allocated to another channel, the channel number is updated to the new channel number and the list is sorted again in ascending order of channel number.
- If the new channel number has already been allocated to another channel, follow the Hotel specifications.

ETC.

- Vertical circulation is supported.

Elements

No	Name	Description
1	Edit Channel Number Window	<ul style="list-style-type: none"> • Both the numeric keys and the Up/Down keys are supported. <ul style="list-style-type: none"> – Selected Channel: Shows the currently selected channel name. – Number: Shows the new channel number. (The currently allocated channel name is also displayed.) – Name: Shows the currently allocated channel name. (If there are no channels, it is displayed as "(Empty)"). : If there is a channel but it does not have a name, the name is represented as "-----".
2	Warning Message	<ul style="list-style-type: none"> • If an already allocated channel is selected <ul style="list-style-type: none"> – If the new channel number has already been allocated to another channel, the confirmation message pops up. (Refer to the figure below.) – If the user wants to change the channel number to one that has already been allocated to another channel, the channel numbers are swapped and saved.

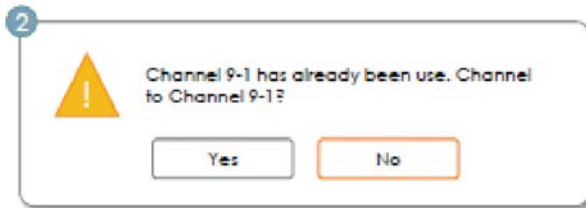

Edit the Channel Number [External Input] (3/3)

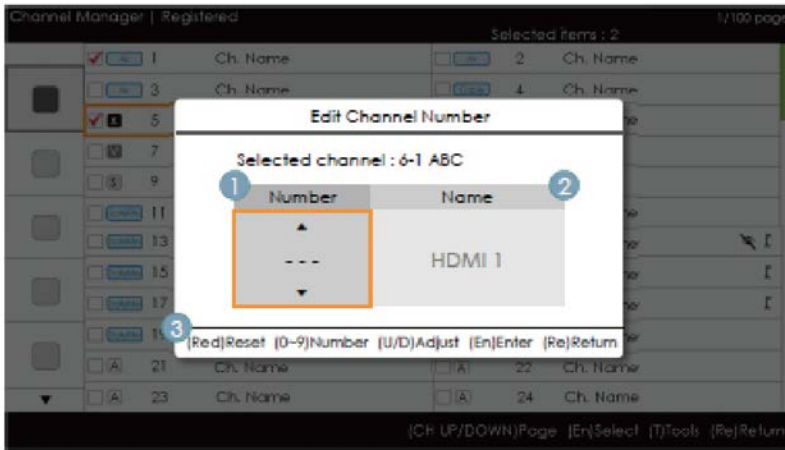

- Hotel Option Menu > Channel > Channel Editor > Tool > Edit Channel Number

Key Guide

Button	Action	Nav. Help
RED	If a user presses the button, the channel number is initialized.	Reset
Enter	Applies the changes and closes the window.	Select
RETURN	Cancels or returns to the previous screen (Tools).	Return
▲/▼	Changes the channel number of the selected channel.	Adjust
0~9	Enters a digit.	Number
INFO	N/R	N/R
TOOLS	Closes the current window and displays the 'Tools' menu.	(No Guide)
EXIT	Cancels and returns to the previous step (Factory Mode).	(No Guide)

NOTE

- This function allocates an external input source to a channel number. (The changes are applied to all the channels.)
- If the new channel number has already been allocated to another channel, follow the Hotel specifications.

ETC.

- Default Highlight: Channel number area.
- Vertical circulation is supported.
- Timeout (60 sec)

Elements

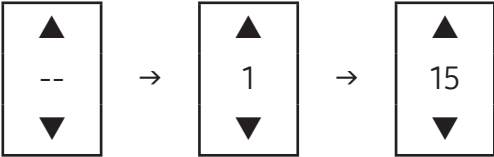
No	Name	Description
1	Channel Number Area	<ul style="list-style-type: none"> The channel number area. <ul style="list-style-type: none"> Both the numeric keys and the Up/Down keys are supported. If no value is allocated, as many '-' are displayed as the number of digits. 
2	Source Name	<ul style="list-style-type: none"> External input name <ul style="list-style-type: none"> Items that cannot be configured are disabled.
3	Nav. Help Area	<ul style="list-style-type: none"> If a user presses the red button, the channel number is initialized.

Rename Channel



- Hotel Option Menu > Channel > Channel Editor > Tool > Rename Channel

Key Guide

Button	Action	Nav. Help
GREEN	Saves the changes and returns to the Channel Editor.	Done
Enter	Saves the channel name and moves the cursor to the next field.	Select
RETURN	Cancels and returns to the previous screen (Tools).	Return
▲/▼/◀/▶	Navigates on the keyboard.	Move
0~9	Enters a digit.	(No Guide)
INFO	N/R	N/R
TOOLS	Closes the current window and displays the 'Tools' menu.	(No Guide)
EXIT	Cancels and returns to the previous step (Factory Mode).	(No Guide)

NOTE

- This is the definition of the keypad that is used for the Edit Channel Name function.

ETC.

- Timeout (60 sec)

Elements

No	Name	Description
1	Channel Name Edit Window	
2	Channel Name	<ul style="list-style-type: none"> The cursor and the character that are currently being entered are in the same colour as the highlight. When the maximum number of characters is reached, the cursor disappears.
3	Keyboard	<ul style="list-style-type: none"> For a detailed scenario, refer to the keypad design document.

Tools [Edit Mode]

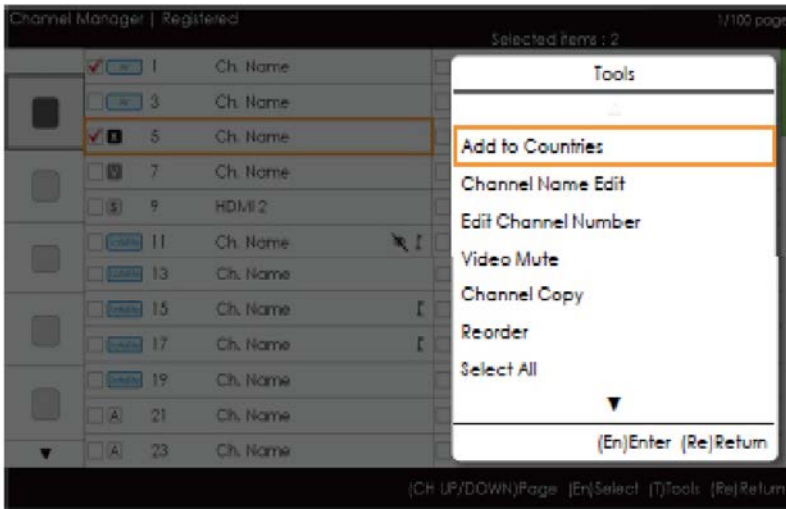

Edit Mode	
Content Highlight (when the number of the checked item is 0 or 1)	When there is more than one checked item.
Add to Countries Edit Countries (when an already-registered item is checked.) Channel Name Edit Edit Channel Number Video Mute Channel Copy (Astra HD +) Reorder (Satellite) Select All Deselect All (this is only displayed when 1 or more items are selected) Delete	Add to Countries Edit Countries (when an already-registered item is checked.) Video Mute Reorder (Satellite) Select All Deselect All Delete

NOTE

- The position of the popup menu: The Tools menu for an item in the left column of the Channel List → This is displayed on the right. The Tools menu for an item in the right column of the Channel List → This is displayed on the left.
- If a user presses the TOOLS button when the highlighted item is not selected, the item is automatically marked as selected.
- For detailed specifications of each function, refer to the NEO Channel Editor.

CH Banner [when a channel number is allocated to an external input]



NOTE

- The TV channel banner specifications are applied.
- When there is an unsupported item or there is no corresponding information, the item values are not displayed.
- The channel name is represented as the 'external input name'.

Elements

No	Name	Description
1	External Input Name	

The Channel List provides access to functions related to GenreTV.

- Country Mode
- Changes the genre mode.

Mixed Channel Map

Mixed Channel Map is a function to mix Air, Cable and Satellite channels.

[Except for Aus, Singapore, NZ models]

- Mixed Channel Map should be ON in order to mix Air, Cable and Satellite channels.
- Use Channel Editor to sort the channels after turning on 'Mixed Channel Map' in Hotel Option Menu.

Sound Bar

- **Samsung Sound-Bars and Hospitality TV**
 - Use Samsung Sound-Bars and Hospitality TV that support the ARC feature with HDMI. If you connect a compatible Samsung Sound-Bar to a compatible Samsung hospitality TV using a single HDMI cable, guests can listen to the TV's sound through the Sound-Bar.
 - Models supporting the ARC function are listed below:
 - Sound-Bars:
 - HW-H450/H550/H570/H600/H7500
 - HW-J450/J470/J550
 - HW-K450/K550
- **Setting the Sound-Bars to Hotel Mode**
 1. Set the following Hotel menu options:
 - Hotel Option > System > Sound Bar Out = On
 - Hotel Option > Power On > Power On Volume > User Defined
 - Hotel Option > Power On > Power On Volume > Set greater than 0
 - Hotel Option > Power On > Max Volume > Set greater than 0
 2. Connect an HDMI cable from the HDMI OUT jack on the back of Sound-Bar to the HDMI port (supporting ARC) on the hospitality TV.
 3. After the Sound-Bar is connected to the hospitality TV, when the TV turns on, the Sound-Bar automatically detects the TV, and then automatically switches to Hotel Mode.

Sound Bar Hotel mode functional characteristics:

- Power On/Off is synchronized with the TV
- HDMI_CEC defaults to On
- Functions through the "HDMI OUT" port only
- Disables the "Input mode" key on the VFD to prevent unexpected audio-source changes.
- Acquires adjustable Power On and Max Volume settings from the TV's Hotel Option menu. The Sound-Bar's Power On Volume and Max Volume values, however, are ½ of the Power On Volume and Max Volume settings in the TV's Hotel Option menu.
Example: If the TV's Power On Volume=20 and Max Volume=90, then the Sound Bar's Power On Volume=10 and Max Volume=45.

*This function may differ depending on the model.

Security mode

Design Specifications

- This is to restrict some functions such as TTX and external source (HDMI, USB) input in specific facilities such as a correctional facility.
- The Security menu is password-protected. Access to the Security menu is denied without the password.
- Security Setting
 - The Security Setting can be set to ON or OFF.
 - The default is OFF.
 - Security Setting: If set to On, external source (HDMI, USB) input and the TTX function will be disabled.
- Password Setting
 - This allows users to change the password.
 - Users must input the current password, a new password, and confirmation of the new password.
- Password Reset
 - This is to reset the password.
 - The default password is "00000000".
 - Password Reset is visible only in the Factory menu by using the key combination of Info and Factory. It is not visible using the key combination of MUTE → 1 → 1 → 9 → ENTER .
- Security Setting: If set to On, the SIRCH function is not available.
- Factory Reset will not reset the Security Setting.

Installing the Wall Mount

The wall mount kit (sold separately) allows you to mount the TV on the wall. For detailed information on installing the wall mount, see the instructions provided with the wall mount. Contact a technician for assistance when installing the wall mount bracket. We do not advise you to do it yourself.

Samsung Electronics is not responsible for any damage to the product or injury to yourself or others if you select to install the TV on your own.

Wall Mount Kit Specifications (VESA)

 The Wall mount kit is not supplied but sold separately.

Install your wall mount on a solid wall, perpendicular to the floor. When attaching to other building materials, please contact your nearest dealer. If installing on a ceiling or slanted wall, it may fall and result in severe personal injury.

 **NOTE**

- Standard dimensions for wall mount kits are shown in the table below.
- When purchasing our wall mount kit, a detailed installation manual and all parts necessary for assembly are provided.
- Do not use screws that do not comply with VESA standard screw specifications.
- Do not use screws longer than the standard dimensions, as they may cause damage to the inside of the TV set.
- For wall mounts that do not comply with the VESA standard screw specifications, the length of the screws may differ depending on their specifications.
- Do not fasten the screws too tightly. This may... damage the product or cause the product to fall, leading to personal injury. Samsung is not liable for these kinds of accidents.
- Samsung is not liable for product damage or personal injury when a non-VESA or non-specified wall mount is used or the consumer fails to follow the product installation instructions.
- Do not exceed a 15 degrees tilt when mounting this TV.

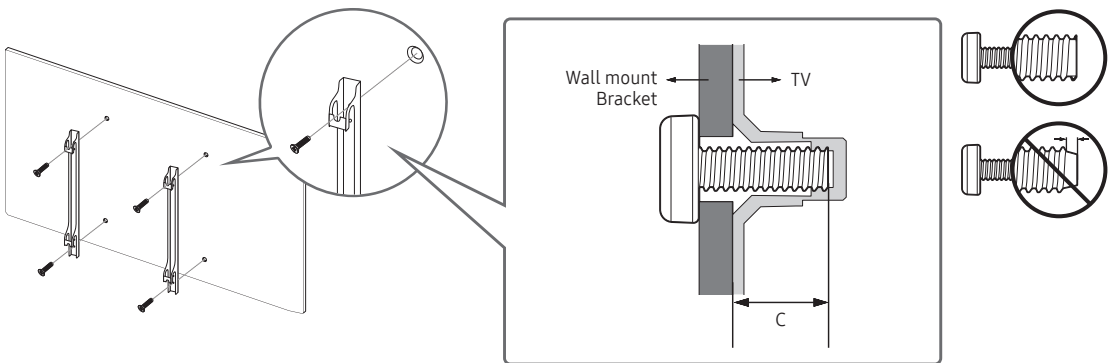

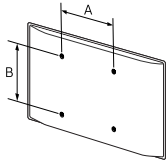
inches	VESA Spec. (A * B)	C (mm)	Standard Screw	Quantity	
32	100 x 100	20.9 - 21.9	M4	4	
49	200 x 200	20 - 21	M8		

 Do not install your Wall Mount Kit while your TV is turned on. It may result in personal injury due to electric shock.

Securing the TV to the Wall



Caution: Pulling, pushing, or climbing onto the TV may cause the TV to fall. In particular, ensure that your children do not hang over or destabilize the TV; doing so may cause the TV to tip over, resulting in serious injuries or death. Follow all safety precautions provided on the included Safety Flyer. For added stability, install the anti-fall device for safety purposes, as follows.



To avoid the TV from falling

- Put the screws into the clamps and firmly fasten them onto the wall. Confirm that the screws have been firmly installed onto the wall.
 - You may need additional material, such as an anchor, depending on the type of wall.
 - Since the necessary clamps, screws, and string are not supplied, please purchase these additionally.
- Remove the screws from the centre back of the TV, put the screws into the clamps, and then fasten the screws onto the TV again.
 - Screws may not be supplied with the product. In this case, please purchase the screws of the following specifications.
- Connect the clamps fixed onto the TV and the clamps fixed onto the wall with a strong string and then tie the string tightly.
 - NOTE**
 - Install the TV near to the wall so that it does not fall backwards.
 - It is safe to connect the string so that the clamps fixed on the wall are equal to or lower than the clamps fixed on the TV.
 - Untie the string before moving the TV.
- Verify that all connections are properly secured. Periodically check connections for any sign of fatigue for failure. If you have any doubt about the security of your connections, contact a professional installer.

Anti-theft Kensington Lock

The Kensington Lock is not supplied by Samsung. It is a device used to physically fix the system when using it in a public place. The appearance and locking method may differ from the illustration, depending on the manufacturer. Refer to the manual provided with the Kensington Lock for additional information on proper use.

To lock the product, follow these steps:

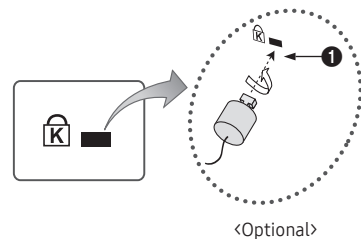

Please find the “” icon on the rear of the TV. A Kensington slot is beside the “” icon.



- Wrap the Kensington lock cable around a large, stationary object such as a desk or chair.
- Slide the end of the cable with the lock attached through the looped end of the Kensington lock cable.
- Insert the locking device into the Kensington slot on the product (❶).
- Lock the lock.
 - These are general instructions. For exact instructions, see the Install Guide supplied with the locking device.
 - The locking device has to be purchased separately.
 - The location of the Kensington Lock may be different depending on the model.

Specifications

Environmental Considerations		
Operating Temperature	10°C to 40°C (50°F to 104°F)	
Operating Humidity	10% to 80%, non-condensing	
Storage Temperature	-20°C to 45°C (-4°F to 113°F)	
Storage Humidity	5% to 95%, non-condensing	
Model Name	HG32EE590	HG49EE590
Display Resolution	1366 x 768	1920 x 1080
Screen Size (Diagonal)	32 inches (80 cm)	49 inches (123 cm)
Sound (Output)	10 W	20 W
Stand Swivel (Left / Right)	20° / 60° / 90°	20° / 60° / 90°
Dimensions (W x H x D)		
Body	745.4 x 442.2 x 69.0 mm	1118.8 x 650.0 x 74.2 mm
With stand	745.4 x 484.2 x 192.6 mm	1118.8 x 700.1 x 226.5 mm
Weight		
Without Stand	4.3 kg	10.3 kg
With Stand	5.8 kg	13.3 kg

-  Design and specifications are subject to change without prior notice.
-  For power supply and power consumption information, refer to the label attached to the product.

Dimensions

Front view / Side view

- HG32EE590 / HG49EE590

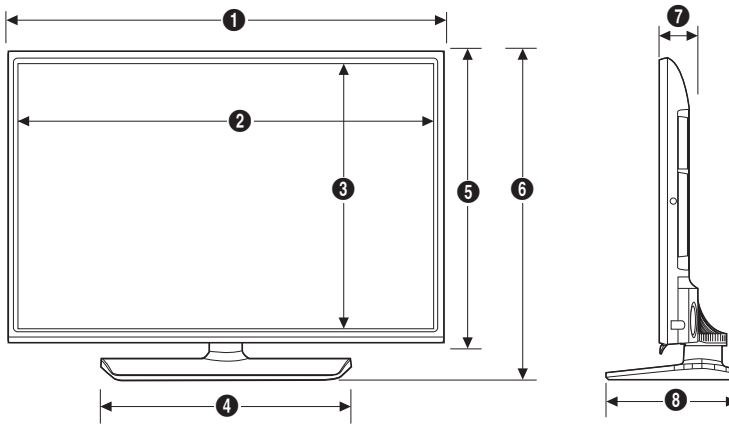

(Unit: mm)

	1	2	3	4	5	6	7	8
HG32EE590	745.4	699.7	394.3	451.2	442.2	484.2	69.0	192.6
HG49EE590	1118.8	1075.8	606.0	556.5	650.0	700.1	74.2	226.5

Jack panel detail / Rear view

📎 Detailed dimensions can be checked at Displaysolutions.samsung.com.

Base Stand detail

- HG32EE590

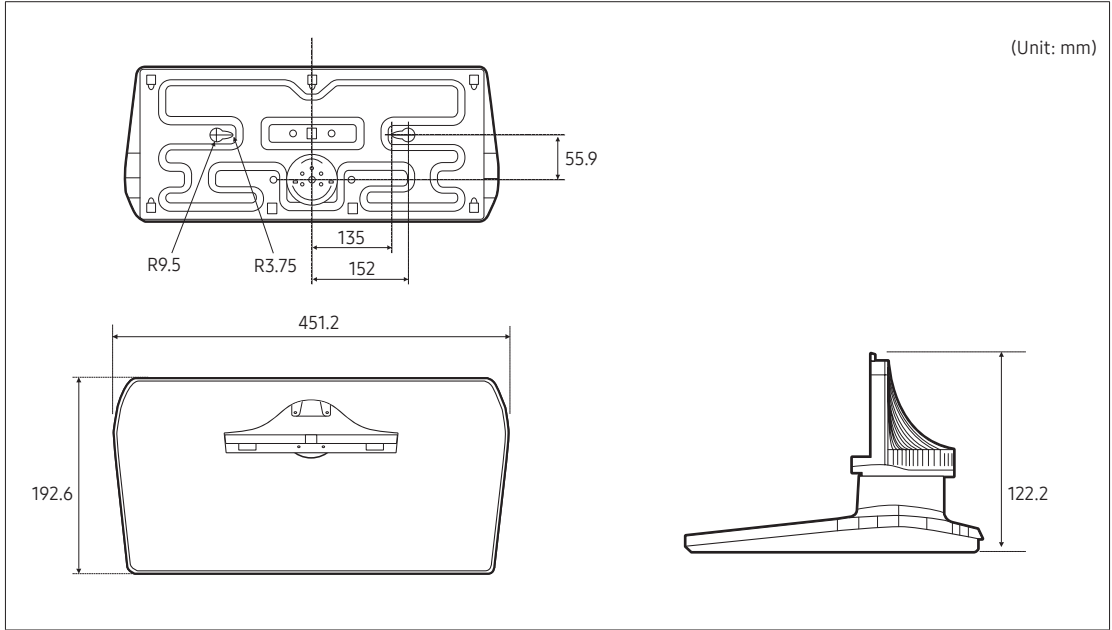

- HG49EE590

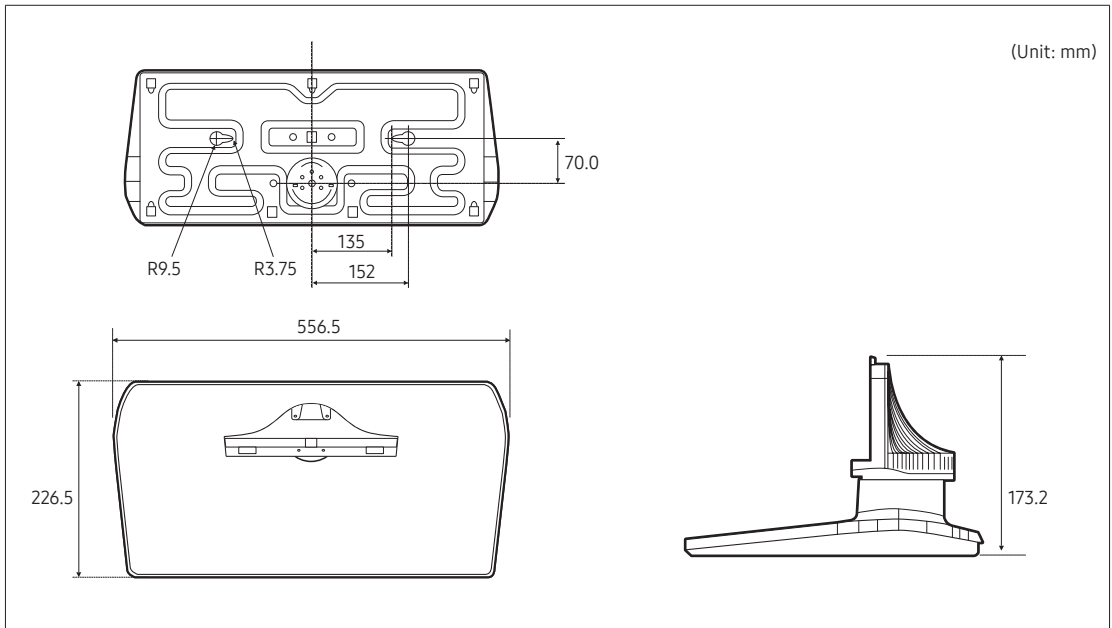

NOTE: All drawings are not necessarily to scale. Some dimensions are subject to change without prior notice. Refer to the dimensions prior to performing installation of your TV. Not responsible for typographical or printed errors.

Licence



Manufactured under license from Dolby Laboratories. Dolby, Dolby Audio, Pro Logic, and the double-D symbol are trademarks of Dolby Laboratories.



For DTS patents, see <http://patents.dts.com>. Manufactured under license from DTS, Inc. DTS, the Symbol, DTS in combination with the Symbol, DTS Premium Sound|5.1, DTS Digital Surround, DTS Express, and DTS Neo2:5 are registered trademarks or trademarks of DTS, Inc. in the United States and/or other countries.
© DTS, Inc. All Rights Reserved.



For DTS patents, see <http://patents.dts.com>. Manufactured under license from DTS Licensing Limited. DTS, the Symbol, DTS in combination with the Symbol, and DTS Studio Sound are registered trademarks or trademarks of DTS, Inc. in the United States and/or other countries.
© DTS, Inc. All Rights Reserved.



The terms HDMI and HDMI High-Definition Multimedia Interface, and the HDMI Logo are trademarks or registered trademarks of HDMI Licensing LLC in the United States and other countries.



This DivX Certified® device has passed rigorous testing to ensure it plays DivX® video.
To play purchased DivX movies, first register your device at vod.divx.com. Find your registration code in the DivX VOD section of your device setup menu.
DivX Certified® to play DivX® video up to HD 1080p, including premium content.
DivX®, DivX Certified® and associated logos are trademarks of DivX, LLC and are used under license.
Covered by one or more of the following U.S. patents: 7,295,673; 7,460,668; 7,515,710; 8,656,183; 8,731,369; RE45,052.

Open Source License Notice

Open Source used in this product can be found on the following webpage. (<http://opensource.samsung.com>)
Open Source License Notice is written only English.

SAMSUNG

Contact SAMSUNG WORLD WIDE

If you have any questions or comments relating to Samsung products, please contact the SAMSUNG customer care centre.

Country	Customer Care Centre 	Web Site
AUSTRIA	0800-SAMSUNG (0800-7267864) [Only for Dealers] 0810-112233	www.samsung.com/at/support
BELGIUM	02-201-24-18	www.samsung.com/be/support (Dutch) www.samsung.com/be_fr/support (French)
BOSNIA	055 233 999	www.samsung.com/support
BULGARIA	*3000 Цена в мрежата 0800 111 31, Безплатна телефонна линия	www.samsung.com/bg/support
CROATIA	072 726 786	www.samsung.com/hr/support
CZECH	800 - SAMSUNG (800-726786) Samsung Electronics Czech and Slovak, s.r.o. V Parku 2323/14, 148 00 - Praha 4	www.samsung.com/cz/support
DENMARK	707 019 70	www.samsung.com/dk/support
FINLAND	030-6227 515	www.samsung.com/fi/support
FRANCE	01 48 63 00 00	www.samsung.com/fr/support
GERMANY	06196 77 555 77	www.samsung.com/de/support
CYPRUS	8009 4000 only from landline, toll free	
GREECE	80111-SAMSUNG (80111 726 7864) only from land line (+30) 210 6897691 from mobile and land line	www.samsung.com/gr/support
HUNGARY	0680SAMSUNG (0680-726-7864)	www.samsung.com/hu/support
ITALIA	800-SAMSUNG (800.7267864)	www.samsung.com/it/support
LUXEMBURG	261 03 710	www.samsung.com/be_fr/support
MONTENEGRO	020 405 888	www.samsung.com/support
SLOVENIA	080 697 267 (brezplačna številka)	www.samsung.com/si/support
NETHERLANDS	088 90 90 100	www.samsung.com/nl/support
NORWAY	815 56480	www.samsung.com/no/support
POLAND	801-172-678* lub +48 22 607-93-33* * (koszt połączenia według taryfy operatora)	www.samsung.com/pl/support
PORTUGAL	808 207 267	www.samsung.com/pt/support
ROMANIA	*8000 (apel in retea) 08008-726-78-64 (08008-SAMSUNG) Apel GRATUIT	www.samsung.com/ro/support
SERBIA	011 321 6899	www.samsung.com/rs/support
SLOVAKIA	0800 - SAMSUNG (0800-726 786)	www.samsung.com/sk/support
SPAIN	0034902172678	www.samsung.com/es/support
SWEDEN	0771 726 786	www.samsung.com/se/support
SWITZERLAND	0800 726 78 64 (0800-SAMSUNG)	www.samsung.com/ch/support (German) www.samsung.com/ch_fr/support (French)
UK	0330 SAMSUNG (7267864)	www.samsung.com/uk/support
IRELAND (EIRE)	0818 717100	www.samsung.com/ie/support
LITHUANIA	8-800-77777	www.samsung.com/lt/support
LATVIA	8000-7267	www.samsung.com/lv/support
ESTONIA	800-7267	www.samsung.com/ee/support
TURKEY	444 7711	www.samsung.com/tr/support