

SAMSUNG

INSTALL GUIDE

UHD TV HG43EJ670U HG49EJ670U HG55EJ670U

Thank you for purchasing this Samsung product.

To receive more complete service, please register your product at www.samsung.com

Model _____ Serial No. _____

Before Reading This Install Guide

This TV B2B (Business to Business) model is designed for hotels or the other hospitality businesses, supports a variety of special functions, and lets you limit some user (guest) controls.

Figures and illustrations in this Install Guide are provided for reference only and may differ from the actual product appearance. Product design and specifications may change without notice.

Operational Modes

This TV has two modes: **Interactive** and **Standalone** mode.

- **Interactive** mode: In this mode, the TV communicates with and is fully or partially controlled by a connected Set Back Box (SBB) or Set Top Box (STB) provided by a hospitality System Integration (SI) vendor. When the TV is initially plugged in, it sends a command that attempts to identify the SSB or STB connected to it. If the TV identifies the SBB or STB and the SBB or STB identifies the TV, the TV gives full control to the SBB or STB.
- **Standalone** mode: In this mode, the TV works alone without an external SBB or the STB.

The TV has a **Hotel Option** menu that lets you easily set its various hospitality functions. Please see page 26.

The menu also lets you activate or de-activate some TV and hospitality functions so you can create your optimal hospitality configuration.







Still image warning

Avoid displaying still images (such as jpeg picture files) or still image elements (such as TV channel logos, panorama or 4:3 format images, stock or news bars or crawls) on the screen. Displaying still pictures continually can cause uneven screen wear, which will affect image quality. To reduce the chance that this effect will occur, please follow the recommendations below:

- Avoid displaying the same TV channel for long periods.
- Always try to display a full screen image.
- Reduce brightness and contrast to help prevent the occurrence of after-images.
- Use all TV features designed to reduce image retention and screen burn-in.

Warning! Important Safety Instructions

Please read the Safety Instructions before using your TV.

CAUTION			Class II product: This symbol indicates that a safety connection to electrical earth (ground) is not required.
RISK OF ELECTRIC SHOCK. DO NOT OPEN.			
CAUTION: TO REDUCE THE RISK OF ELECTRIC SHOCK, DO NOT REMOVE COVER (OR BACK). THERE ARE NO USER SERVICEABLE PARTS INSIDE. REFER ALL SERVICING TO QUALIFIED PERSONNEL.			AC voltage: Rated voltage marked with this symbol is AC voltage.
	This symbol indicates that high voltage is present inside. It is dangerous to make any kind of contact with any internal part of this product.		DC voltage: Rated voltage marked with this symbol is DC voltage.
	This symbol indicates that this product has included important literature concerning operation and maintenance.		Caution. Consult instructions for use: This symbol instructs the user to consult the install guide for further safety related information.

- The slots and openings in the cabinet and in the back or bottom are provided for necessary ventilation. To ensure reliable operation of this apparatus and to protect it from overheating, these slots and openings must never be blocked or covered.
 - Do not place this apparatus in a confined space, such as a bookcase or built-in cabinet, unless proper ventilation is provided.
 - Do not place this apparatus near or over a radiator or heat register, or where it is exposed to direct sunlight.
 - Do not place vessels (vases etc.) containing water on this apparatus, as this can result in a fire or electric shock.
- Do not expose this apparatus to rain or place it near water (near a bathtub, washbowl, kitchen sink, or laundry tub, in a wet basement, or near a swimming pool, etc.). If this apparatus accidentally gets wet, unplug it and contact an authorised dealer immediately.
- This apparatus uses batteries. In your community, there might be environmental regulations that require you to dispose of these batteries properly. Please contact your local authorities for disposal or recycling information.
- Do not overload wall outlets, extension cords, or adaptors beyond their capacity, since this can result in fire or electric shock.
- Power-supply cords should be placed so that they are not likely to be walked on or pinched by items placed upon or against them. Pay particular attention to cords at the plug end, at wall outlets, and at the point where they exit from the appliance.
- To protect this apparatus from a lightning storm, or when left unattended and unused for long periods of time, unplug it from the wall outlet and disconnect the antenna or cable system. This will prevent damage to the set due to lightning and power line surges.

- Before connecting the AC power cord to the DC adaptor outlet, make sure that the voltage designation of the DC adaptor corresponds to the local electrical supply.
- Never insert anything metallic into the open parts of this apparatus. This may cause a danger of electric shock.
- To avoid electric shock, never touch the inside of this apparatus. Only a qualified technician should open this apparatus.
- Be sure to plug in the power cord until it is firmly seated. When unplugging the power cord from a wall outlet, always pull on the power cord's plug. Never unplug it by pulling on the power cord. Do not touch the power cord with wet hands.
- If this apparatus does not operate normally - in particular, if there are any unusual sounds or smells coming from it - unplug it immediately and contact an authorised dealer or service centre.
- Be sure to pull the power plug out of the outlet if the TV is to remain unused or if you are to leave the house for an extended period of time (especially when children, elderly, or disabled people will be left alone in the house).
 - Accumulated dust can cause an electric shock, an electric leakage, or a fire by causing the power cord to generate sparks and heat or by causing the insulation to deteriorate.
- Be sure to contact an authorised Samsung service centre for information if you intend to install your TV in a location with heavy dust, high or low temperatures, high humidity, chemical substances, or where it will operate 24 hours a day such as in an airport, a train station, etc. Failure to do so may lead to serious damage to your TV.
- Use only a properly grounded plug and wall outlet.
 - An improper ground may cause electric shock or equipment damage. (Class I Equipment only.)
- To turn off this apparatus completely, disconnect it from the wall outlet. To ensure you can unplug this apparatus quickly if necessary, make sure that the wall outlet and power plug are readily accessible.
- Store the accessories (batteries, etc.) in a location safely out of the reach of children.
- Do not drop or strike the product. If the product is damaged, disconnect the power cord and contact a Samsung service centre.
- To clean this apparatus, unplug the power cord from the wall outlet and wipe the product with a soft, dry cloth. Do not use any chemicals such as wax, benzene, alcohol, thinners, insecticide, aerial fresheners, lubricants, or detergents. These chemicals can damage the appearance of the TV or erase the printing on the product.
- Do not expose this apparatus to dripping or splashing.
- Do not dispose of batteries in a fire.
- Do not short-circuit, disassemble, or overheat the batteries.
- There is danger of an explosion if you replace the batteries used in the remote with the wrong type of battery. Replace only with the same or equivalent type.
- **WARNING - TO PREVENT THE SPREAD OF FIRE, KEEP CANDLES AND OTHER ITEMS WITH OPEN FLAMES AWAY FROM THIS PRODUCT AT ALL TIMES.**
- Use care when touching the TV after it has been on for some time. Some parts can be warm to the touch.



Contents

	Before Reading This Install Guide	2
	Warning! Important Safety Instructions	3
01	What's in the Box?	
02	TV Installation	
	Assembling the swivel	9
	Installing the LED TV Stand	10
	Installing the wall mount kit	12
	Securing the TV to the Wall	12
	Wall Mount Kit Specifications (VESA)	13
	Providing proper ventilation for your TV	14
03	The Remote Control	
	About the Buttons on the Remote Control	15
	Installing batteries into the remote control	16
04	Initial Setup	
	Using the TV Controller	18
05	The Connection Panel	
06	Connections	
	Connecting the TV to an SBB or STB	21
	Connecting the RJP (Remote Jack Pack)	22
07	Using a TV Viewing Card ("CI or CI+ Card")	
	Connecting the "CI or CI+ Card" via COMMON INTERFACE slot with the CI CARD Adapter	24
	Using the "CI or CI+ Card"	25

08	Setting the Hotel Option Menus	
	Hotel Option menu items	27
	Welcome Message	34
	Hotel Logo	34
	USB Cloning	35
	Settings Cloned in the Hotel Menu	37
	Setting Auto Initialise	40
	Updating the TV's Software	43
09	Using a Multi Code Remocon	
10	Setting the Soundbar	
	Samsung Soundbar (AirTrack) and Hospitality TVs in 2018	45
11	Editing Channels	
	Channel Bank Editor (Smooovie TV Only)	46
	Using Channel Editor	47
12	Anti-theft Kensington Lock	
13	Specifications and Other Information	
	Specifications	51
	Environmental Considerations	52
	Decreasing power consumption	52
	Supported Resolutions for UHD Input Signals	53
	Display Resolution	53
	Dimensions	55
	Licences	58

01 What's in the Box?

Make sure the following items are included with your TV. If any items are missing, contact your dealer.

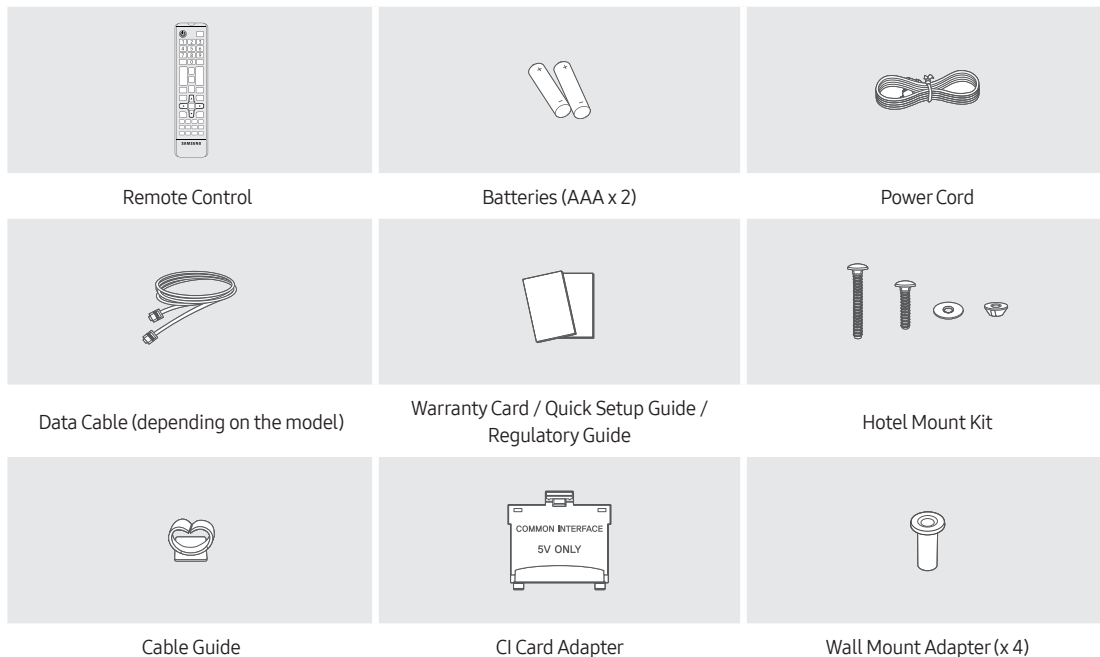

- The items' colours and shapes may vary depending on the models.
- Cables not included can be purchased separately.
- Check for any accessories hidden behind or in the packing materials when opening the box.

An administration fee may be charged in the following situations:

- (a) An engineer is called out at your request, but it is found that the product has no defect (i.e., where the user manual has not been read).
- (b) You bring the unit to a repair centre, but it is found that the product has no defect (i.e., where the user manual has not been read).

You will be informed of the administration fee amount before a technician visits.



The screen can be damaged from direct pressure when handled incorrectly. As shown in the figure, make sure to grip the edges of the screen when you lift the TV.

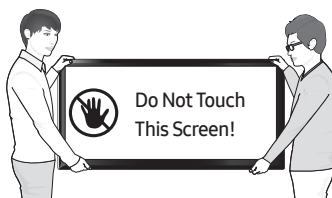



Correct Disposal of This Product (Waste Electrical & Electronic Equipment)

(Applicable in countries with separate collection systems)

This marking on the product, accessories or literature indicates that the product and its electronic accessories (e.g. charger, headset, USB cable) should not be disposed of with other household waste at the end of their working life. To prevent possible harm to the environment or human health from uncontrolled waste disposal, please separate these items from other types of waste and recycle them responsibly to promote the sustainable reuse of material resources.

Household users should contact either the retailer where they purchased this product, or their local government office, for details of where and how they can take these items for environmentally safe recycling.

Business users should contact their supplier and check the terms and conditions of the purchase contract. This product and its electronic accessories should not be mixed with other commercial wastes for disposal.



Correct disposal of the batteries in this product

(Applicable in countries with separate collection systems)

This marking on battery, manual or packaging indicates that the batteries in this product should not be disposed of with other household waste at the end of their working life. Where marked, the chemical symbols Hg, Cd or Pb indicate that the battery contains mercury, cadmium or lead above the reference levels in EC Directive 2006/66. If batteries are not properly disposed of, these substances can cause harm to human health or the environment.

To protect natural resources and to promote material reuse, please separate batteries from other types of waste and recycle them through your local, free battery return system.

For information on Samsung's environmental commitments and product-specific regulatory obligations, e.g. REACH, WEEE, Batteries, visit http://www.samsung.com/uk/aboutsamsung/samsungelectronics/corporatecitizenship/data_corner.html

02 TV Installation

Assembling the swivel



WARNING: If you configure the TV to swivel, you must attach it securely to the floor, a desk, a dresser top, etc. as described in the installation instructions.

The LED TVs have swivel stands. You can configure these stands so that the TVs swivel 20 degrees left and right, 60 degrees left and right, or 90 degrees left and right using the BRACKET HOLDER SWIVEL.

* The product ships with its stand's swivel angle set to 20°.

* 20° swivel

To configure the TV so that it swivels 20° left and right, insert the prong on the bottom of the stand through the curved hole in the Bracket Holder Swivel marked 20°. Then, fix the Bracket Holder Swivel to the stand using the three supplied screws as shown below.

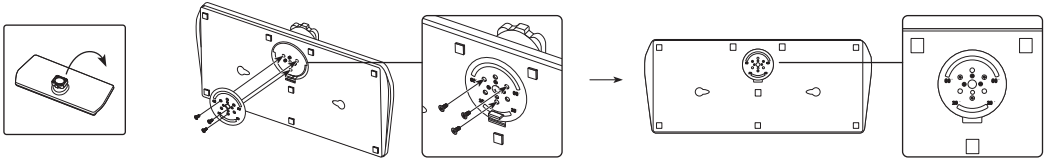

60° swivel

To configure the TV so that it swivels 60° left and right, insert the prong on the bottom of the stand through the curved hole in the Bracket Holder Swivel marked 60°. Then, fix the Bracket Holder Swivel to the stand using the three supplied screws as shown below.

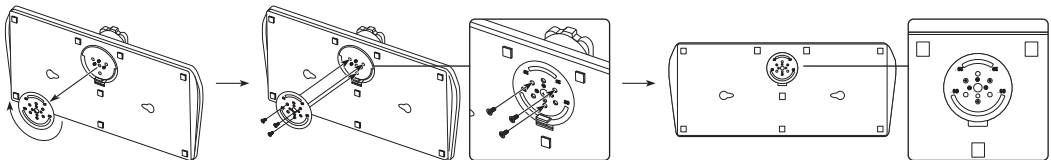

90° swivel

To configure the TV so that it swivels 90° left and right, remove the Bracket Holder Swivel, and then screw the three supplied screws into the stand as shown below.

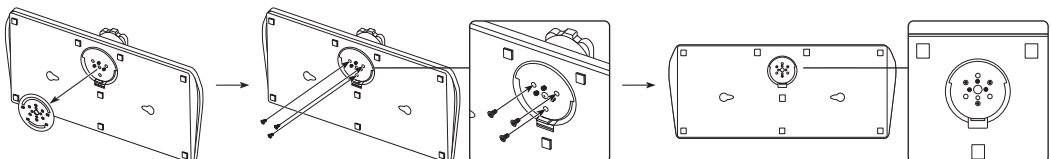

Installing the LED TV Stand

Assembling the Stand and Components

When installing the stand, use the provided components and parts.

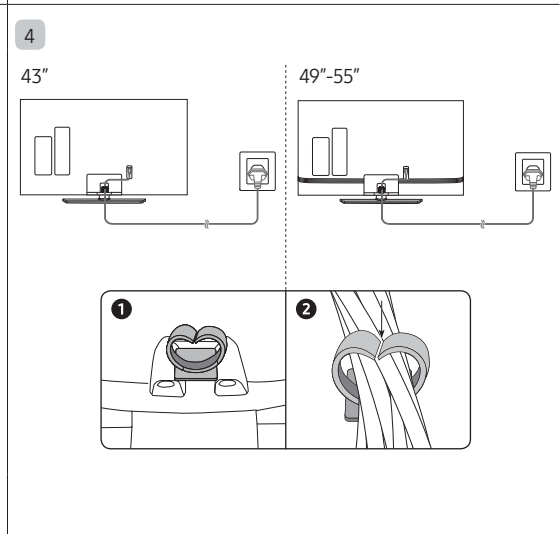
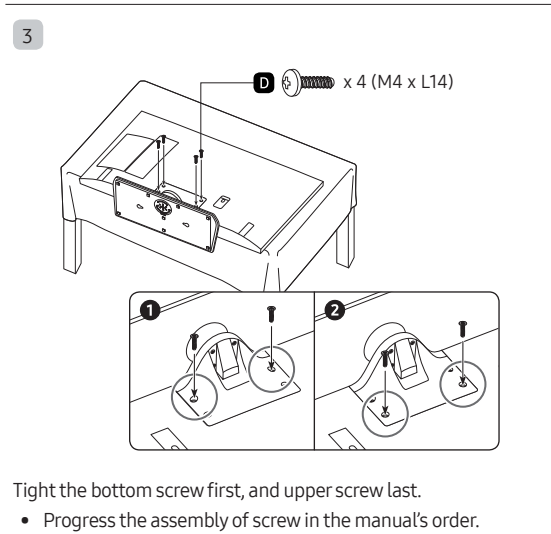
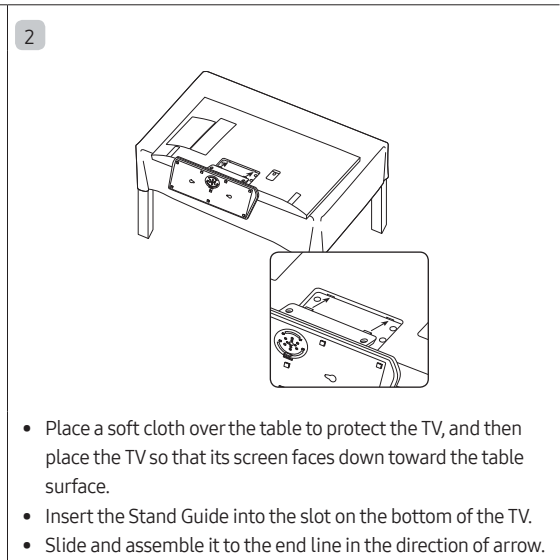
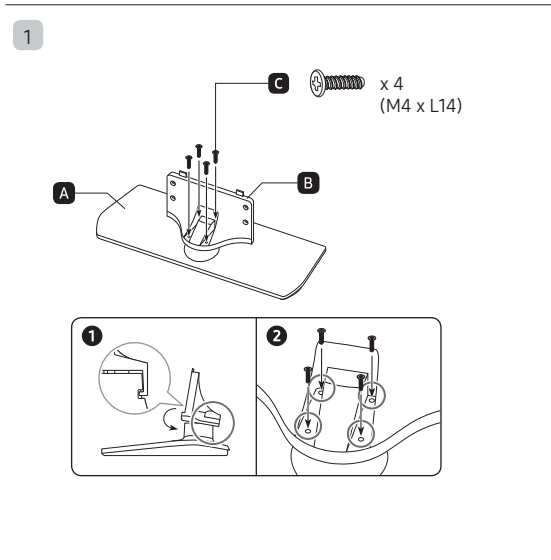
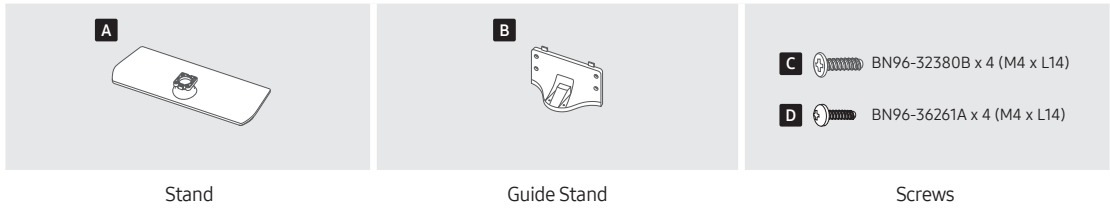

NOTE

- Make sure to distinguish between the front and back of each component when assembling them.
- Make sure that at least two persons lift and move the TV.

Assembling the Hotel Mount Kit

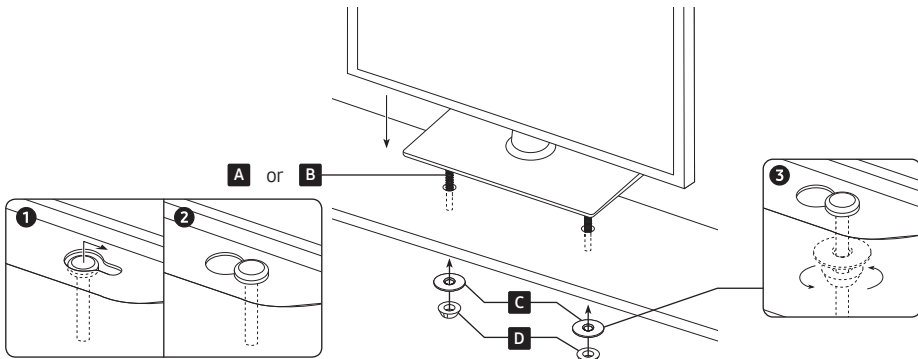

⚠ Affix the stand to a flat surface such as a dresser top, desk top, or entertainment centre as shown.



WARNING: To prevent injury, you must attach this TV securely to the floor, a table, a dresser top, etc. with the Hotel Mount Kit as described in these instructions.

Installing the wall mount kit

You can mount the TV on the wall using a wall mount kit (sold separately).

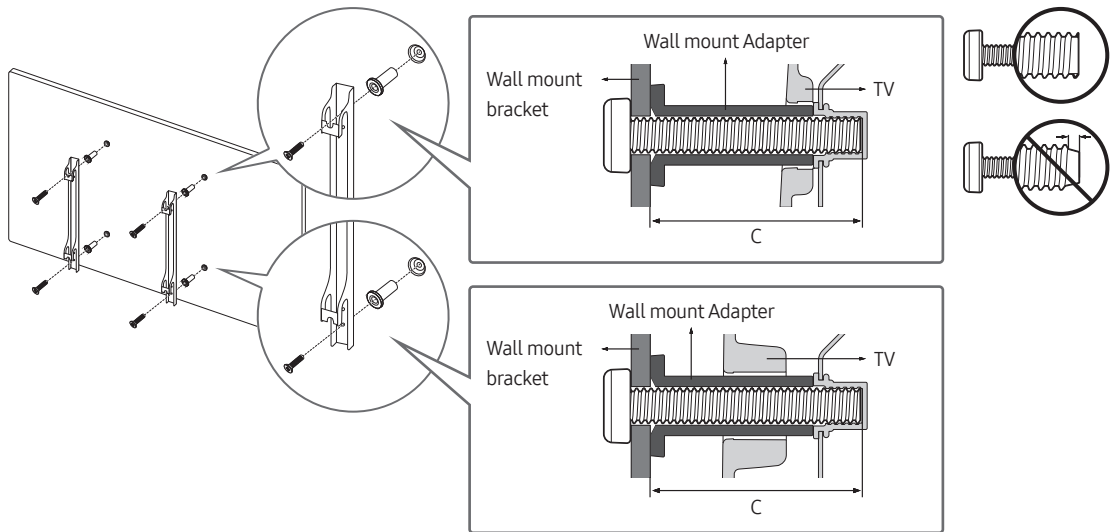

- The Product shape may differ depending on the model.

The wall mount kit (sold separately) allows you to mount the TV on a wall.

For detailed information on installing the wall mount, see the instructions provided with the wall mount. Contact a technician for assistance when installing the wall mount bracket. Samsung Electronics is not responsible for any damage to the product or injury to yourself or others if you select to install the TV on your own.

Securing the TV to the Wall



Caution: Pulling, pushing, or climbing on the TV may cause the TV to fall. In particular, ensure your children do not hang on or destabilise the TV. This action may cause the TV to tip over, causing serious injuries or death. Follow all safety precautions provided in the Safety Flyer included with your TV. For added stability and safety, you can purchase and install the anti-fall device.

To Prevent the TV from Falling

- TV Holder Kits are sold separately. To purchase a TV Holder Kit, contact Samsung Customer Care.
1. Insert the screws into the wall brackets and firmly fasten them to the wall. Make sure the screws are firmly fixed to the wall.
 - We strongly recommend you drive the screws into a stud.
 2. Insert the screws into the wall brackets and firmly fasten the screws to the top VESA screw holes on the back of the TV.
 3. Connect the brackets on the TV and the brackets on the wall with a strong string or cable, and then tie the string or cable tightly to the brackets.
 - Verify all connections are properly secured. Periodically check the connections for any sign of fatigue or failure. If you have any doubt about the security of your connections, contact a professional installer.
 - Install the TV close to the wall so that it does not fall.
 - Connect the string or cable so that the brackets on the wall are at the same height or lower than the brackets on the TV. Untie the string or cable before moving the TV.

Wall Mount Kit Specifications (VESA)

Install your wall mount on a solid wall perpendicular to the floor. If you are attaching the wall mount to building materials other than plaster board, contact your nearest dealer. If installed on a ceiling or slanted wall, the TV may fall and cause severe personal injury.

- The wall mount kit is not supplied, but sold separately.
- NOTE
 - Standard dimensions for wall mount kits are shown in the table below.
 - Samsung wall mount kits contain a detailed installation manual. All parts necessary for assembly are provided.
 - Do not use screws that do not comply with the VESA standard screw specifications.
 - Do not use screws that are longer than the standard dimension or do not comply with the VESA standard screw specifications. Screws that are too long may cause damage to the inside of the TV set.
 - For wall mounts that do not comply with the VESA standard screw specifications, the length of the screws may differ depending on the wall mount specifications.
 - Do not fasten the screws too firmly. This may damage the product or cause the product to fall, leading to personal injury. Samsung is not liable for these kinds of accidents.
 - Samsung is not liable for product damage or personal injury when a non-VESA or non-specified wall mount is used or the consumer fails to follow the product installation instructions.
 - Do not mount the TV at more than a 15 degree tilt.
 - Always have two people mount the TV onto a wall.

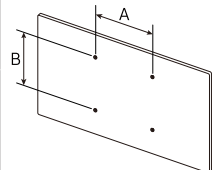
TV size in inches	VESA screw hole specs (A * B) in millimetres	C (mm)	Standard Screw	Quantity	
43-55	200 x 200	43-45	M8	4	



Do not install your wall mount kit while your TV is turned on. This may result in personal injury from electric shock.

Providing proper ventilation for your TV

When you install your TV, maintain a distance of at least 4 inches (10 cm) between the TV and other objects (walls, cabinet sides, etc.) to ensure proper ventilation. Failing to maintain proper ventilation may result in a fire or a problem with the product caused by an increase in its internal temperature.

When you install your TV with a stand or a wall mount, we strongly recommend you use parts provided by Samsung Electronics only. Using parts provided by another manufacturer may cause difficulties with the product or result in injury caused by the product falling.

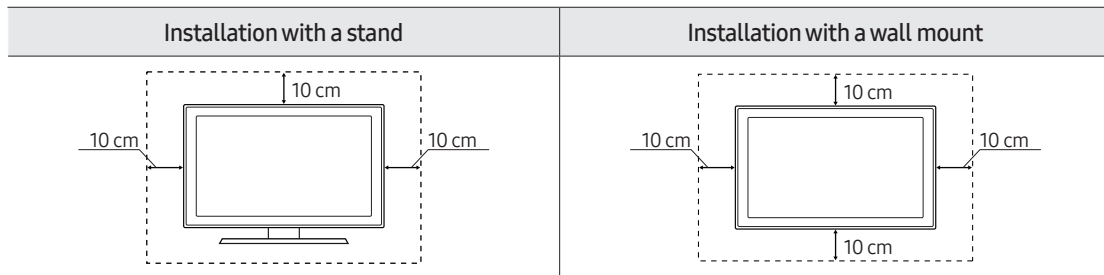

03 The Remote Control

About the Buttons on the Remote Control

- The images, buttons, and functions of the remote control may differ depending on the model.
- The remote control has Braille points on the Power, Channel, Volume, and Select buttons and can be used by visually impaired persons.

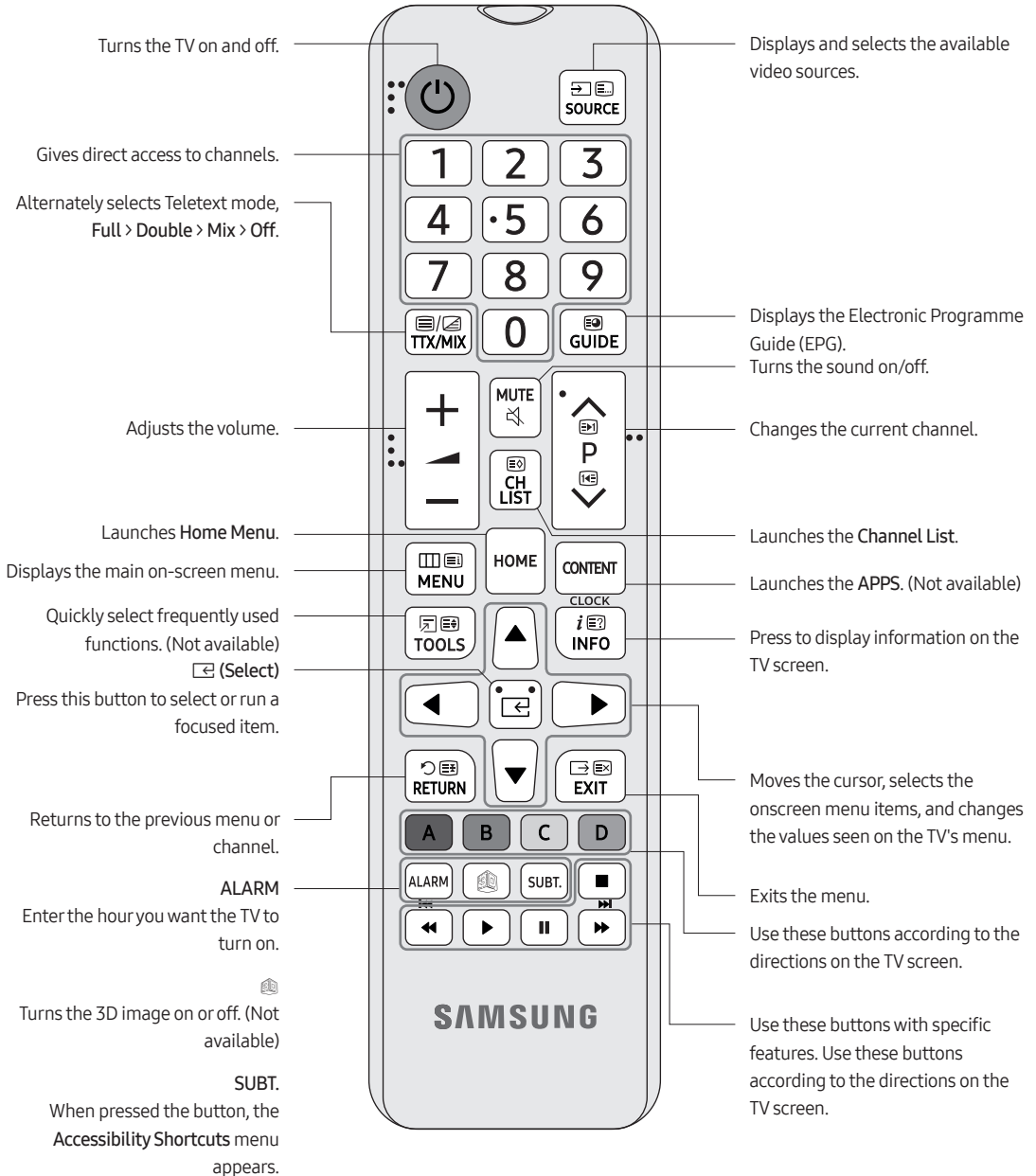

Installing batteries into the remote control

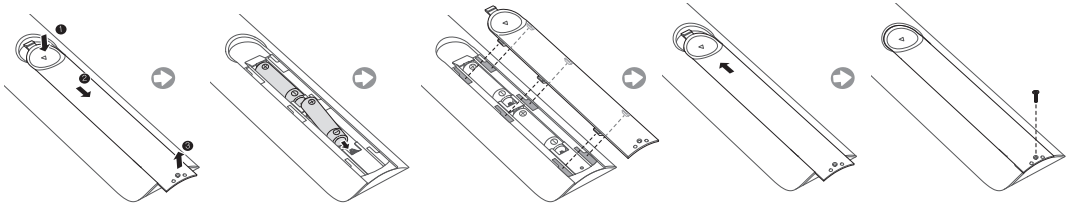

Match the polarity of the batteries to the symbols in the battery compartment.

- Use the remote control within 7 m of the TV.
- Bright light may affect the performance of the remote control. Avoid using near bright fluorescent lights or neon signs.
- The colour and shape of the remote may vary depending on the model.

04 Initial Setup

When you turn on your TV for the first time, it immediately starts the Initial Setup. Follow the instructions displayed on the screen and configure the TV's basic settings to suit your viewing environment.

If you already completed the Initial Setup, run the Initial Setup again using the following menu.

- **Hotel Option (MUTE > 1 > 1 > 9 > Select [] > System > TV Reset**

If you select **TV Reset**, the TV resets all values to their factory defaults. When the TV turns off, press the **POWER** button on the remote control to turn on the TV. The TV starts the Initial Setup.

- The image on your TV may differ from the image above depending on the model and geographical area.

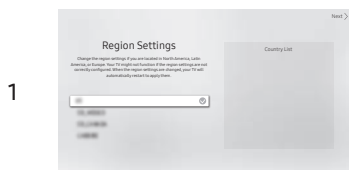

Select the region settings

- Before select region, refer to the country list information on the right.
- If you select the incorrect region, execute **TV Reset** again after the Initial Setup is completed.
- If the region is changed, the TV automatically turns off and on.

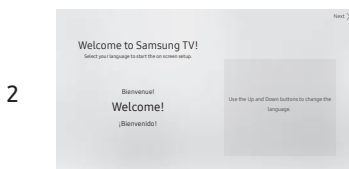

Selecting your language

You can change the menu language.

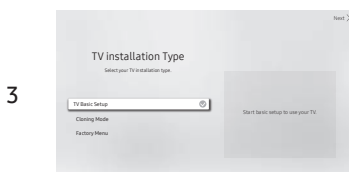

Selecting your TV installation type

- **Basic TV Setup:** Select to proceed to the next step to set the basic options for using your TV.
- **Cloning Mode:** Copy the system settings from the USB or server to the TV.
- **Factory Menu:** End Initial Setup and go to **Hotel Option** menu directly.

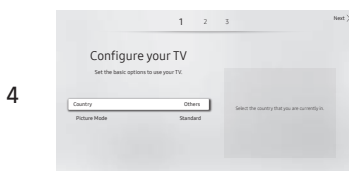

Setting basic options for using your TV

- **Country:** You can select the country that you are currently in.
- **Picture Mode:** You can select the picture mode that provides the best viewing experience.

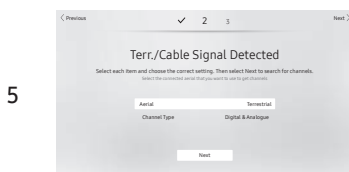

Selecting the broadcasting signal

- You can selecting the connected aerial that you want to use to get channels.

6

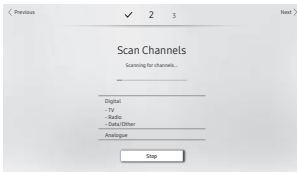

Scanning Channel

- After channel scanning is completed, select **Next** or press the right directional button on the remote control.
- When the RF cable is not connected, this step is skipped.

7

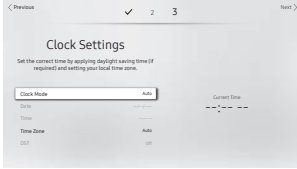

Setting the current time

- If the TV will be tuned to digital broadcast channels, and these channels transmit date and time information, set the **Clock Mode** to **Auto**. The TV will set the date and time automatically.
- If the TV will not be tuned to digital broadcast channels, set the **Clock Mode** to **Manual**, and then set the date and time on the TV manually.
- Set **DST** (Daylight Saving Time) to **On** or **Off** to apply to the TV.
- Select your time zone.

8

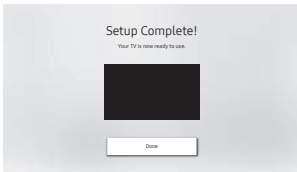

Setup complete

Select the **Done** button to complete the Initial Setup. Then **Hotel Option** menu appears. Press **POWER** button to exit.

Using the TV Controller

You can turn on the TV with the **TV Controller** button at the bottom of the TV, and then use the **Control menu**. The **Control menu** appears when the **TV Controller** is pressed while the TV is On. For more information about its usage, refer to the figure below.

- The screen may dim if the protective film on the **SAMSUNG** logo or the bottom of the TV is not detached. Please remove the protective film.

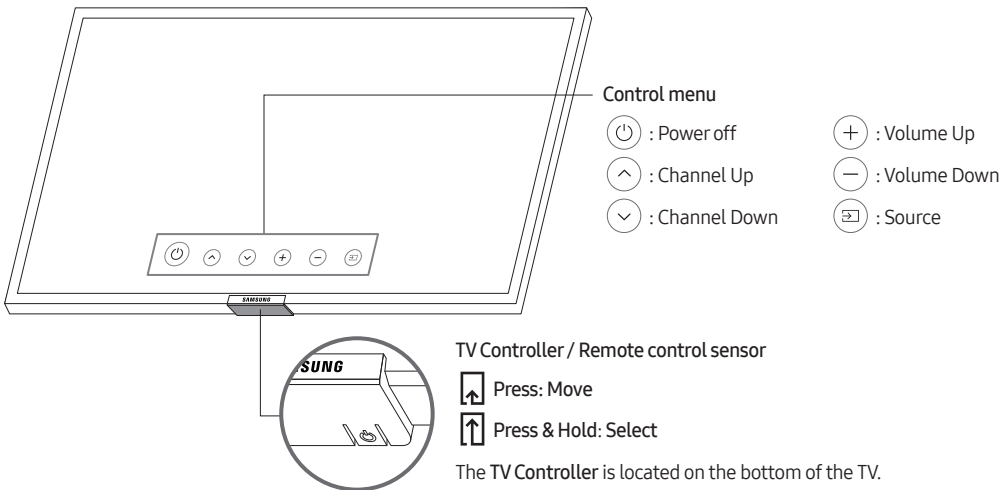

05 The Connection Panel

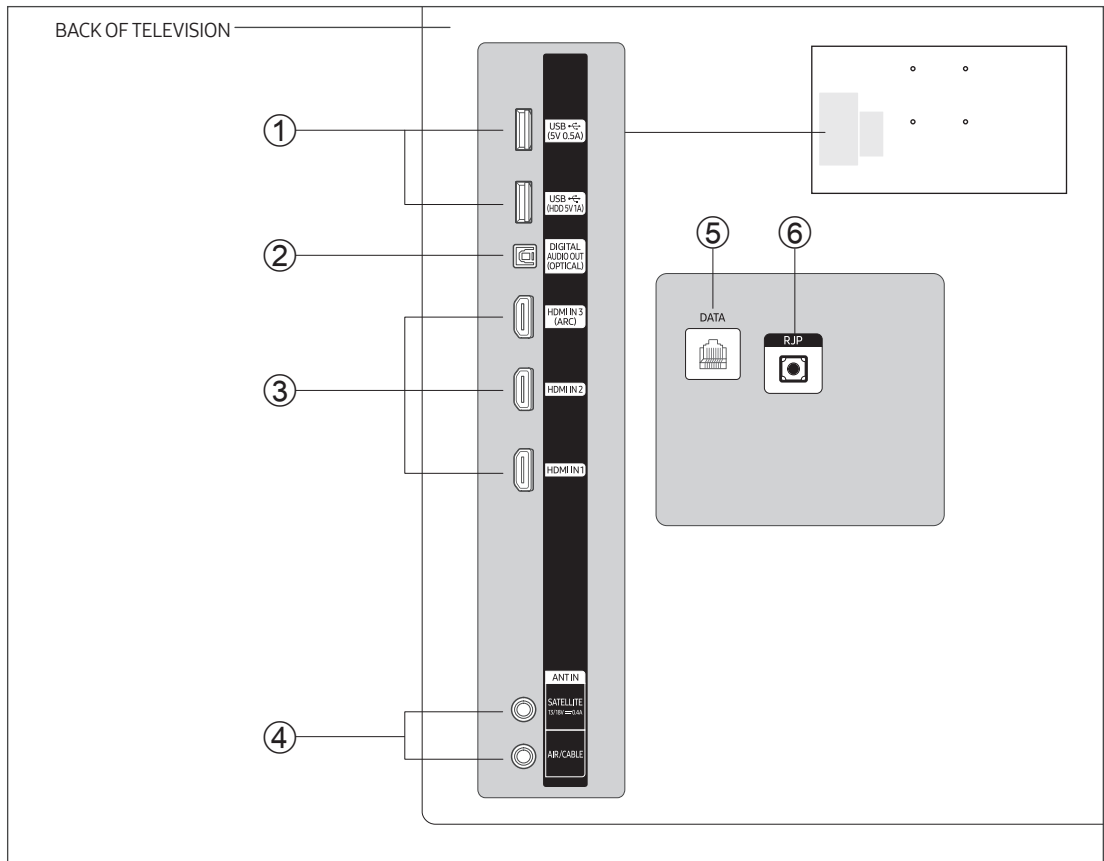

- Whenever you connect an external device to your TV, make sure that power on the TV and the device is turned off.
- When connecting an external device, match the colour of the connection terminal to the cable.

① USB (5V 0.5A), USB (HDD 5V 1A)

- Connector for software upgrades and Media Play, etc.
- Service connection.

② DIGITAL AUDIO OUT (OPTICAL)

Connects to a Digital Audio component.

③ HDMI IN 1, 2, 3 (ARC)

Connects to the HDMI jack of a device with an HDMI output.

- No separate sound connection is needed for an HDMI to HDMI connection. HDMI connections carry both audio and video.
- It is recommended that the external device of the HDMI 1.3 or 1.4 version will be used with this TV. If you meet the compatible problem like no sound or the abnormal screen or etc with the device of the HDMI 1.2 version, contact to the Samsung customer care centre.

④ **ANT IN (SATELLITE), (AIR/CABLE)**

- To view television channels correctly, the TV must receive a signal from one of the following sources:
- An outdoor antenna / A cable television system / A satellite receiver

⑤ **DATA**

- Used to support data communication between the TV and the SBB or STB.
- Connects using RJ-12 TV type plugs.

⑥ **RJP**

Connect this jack to the jack on the optional RJP (Remote Jack Pack). This will allow you to connect external devices (Camcorder, PC, DVD players etc.) easily.

06 Connections

Connecting the TV to an SBB or STB

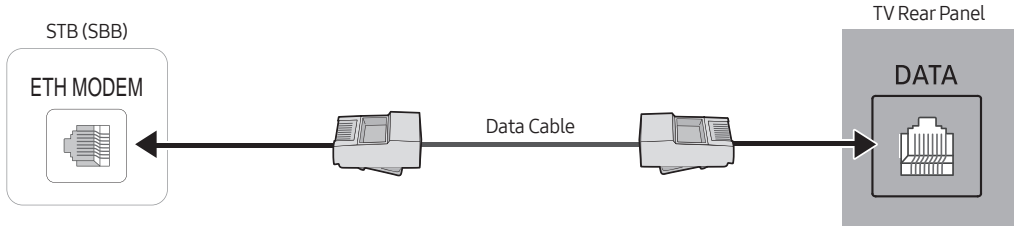

Connect the DATA jack of the TV to the ETH MODEM jack of the STB (SBB) with the Data cable.

- The ETH MODEM jack name that you connect the Data Cable to may differ depending on the SBB or STB type.
- The remote control IR signal need to meet the following specification to use IR pass through function.

IR signal receiver specification

- Band pass filter centre frequency: 379 kHz
- Carrier Frequency, Duty 50%
- Minimum Burst Length (tburst): 12 pulses (316 us)
- Minimum Gap Time Between the burst (tburst gap): 16 pulses (422 us)
- Minimum Gap Time between the data commands (tpause): 25 ms

Compatible Data Cables Supplied with the TV

- Confirm you are using the correct data cable for your vendor. Refer to the code label on the data cables.

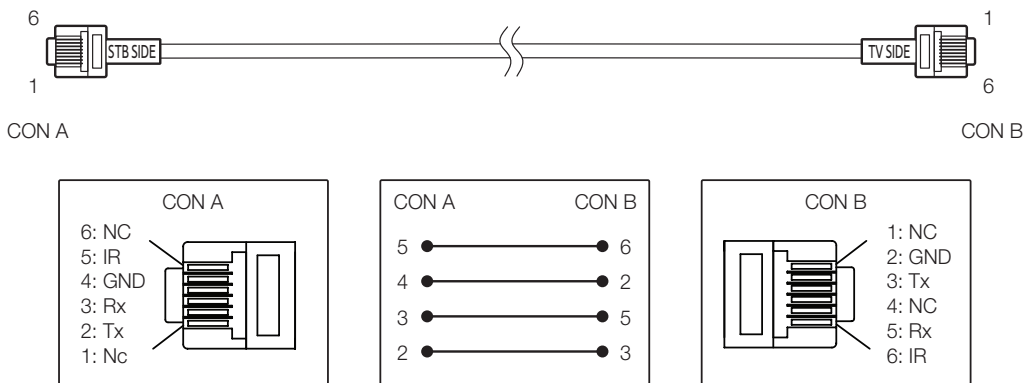

- Operation Specification of Data Cable(RJ12) : RS232

Connecting the RJP (Remote Jack Pack)

Connect the input jacks on the TV to the RJP. The RJP lets guests connect audio and video sources to the TV.

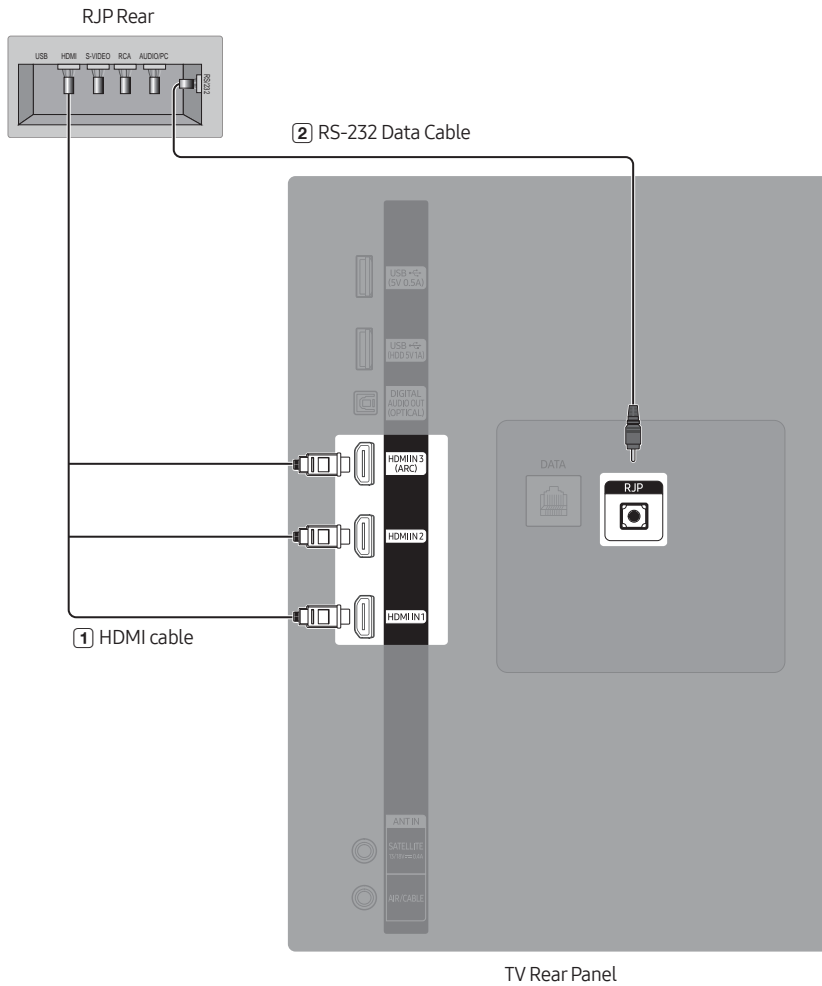

- The rear panel may differ depending on the model.
- ① Connect the **HDMI** port of the TV to the HDMI port of the RJP.
- ② Connect the **RJP** port of the TV to the RS/232 port of the RJP.
 - This Samsung TV is compatible with the TeleAdapt TA-7610 RJP only.

- **RJP (Remote Jack Pack):** The RJP is a hardware module that has various audio and video inputs (PC and HDMI) and corresponding outputs. The corresponding outputs are connected from the RJP to the TV. The RJP communicates with the TV via RS232. The RJP communicates with the TV by sending messages regarding active or inactive sources.
 - A group of **Hotel Option** menu items let you assign numbered priorities to the jacks of the RJP. 1 is the highest priority and 2 is the lowest. When a guest connects external sources to the RJP jacks, the TV will automatically switch between sources based on the priority you have assigned them in the **Hotel Option** menu. For example, lets say **HDMI 1** is set to 1 and **HDMI 2** to 2. If a guest has attached a device to the **HDMI 2** jack, and then plugs a device into the **HDMI 1** jack, the TV automatically switches to the device plugged into the **HDMI 1** jack (the jack with the higher priority). Note that a guest can also switch between devices manually by pushing a button on the RJP.
- To reset the RJP to its factory default state, press the **HDMI 1** and **HDMI 2** buttons simultaneously for 10 seconds. When all button LEDs blink 5 times, the RJP reset is complete.
- The RJP will automatically turn off any LEDs after 5 minutes to avoid unnecessary light pollution in the hotel room. The LEDs that were turned off will turn on again if the guest touches any of the buttons and the 5 minute timer will restart. If the guest then touches another source button, the TV will change to the selected source and the corresponding LED will be lit.
- After the RJP reset or the TV turns off/on, it takes approximately 10 seconds to establish communications between the TV and the RJP.
- The following table shows the approximate time in seconds it takes to switch from the TV to an input source, based on assigned or default priorities.

Source	To Connect
HDMI	3.9 sec

- When two or more inputs are connected to the RJP and one of the input sources is disconnected and then reconnected.

Source	Disconnect	To Connect	Total
HDMI	3.9 sec	3.9 sec	7.8 sec

- If the RJP has all its live sources connected, HDMI has been assigned the highest priority, the RJP is in HDMI mode, and a guest removes and reconnects the HDMI source, the minimum time required to switch to the **HDMI 1** source is 7.8 seconds.
- **HDMI Music Mode** is available for the Guestlink RJP only.

07 Using a TV Viewing Card (“CI or CI+ Card”)

Watches paid channels by inserting your TV viewing card into the COMMON INTERFACE slot.

- The 2 CI card slots may not be supported depending on the model.
- Turn the TV off to connect or disconnect a “CI or CI+ Card”.
- The TV Viewing Card (“CI or CI+ Card”) may not supported depending on the model.

Connecting the “CI or CI+ Card” via COMMON INTERFACE slot with the CI CARD Adapter

Attaching the CI CARD Adapter via COMMON INTERFACE slot

To attach the CI CARD Adapter to the TV, follow these steps:

- ① Insert the CI CARD Adapter into the two holes on the back of TV.
 - Please locate the two holes at the back of the TV next to the COMMON INTERFACE slot.
- ② Connect the CI CARD Adapter to the COMMON INTERFACE slot on the back of TV.

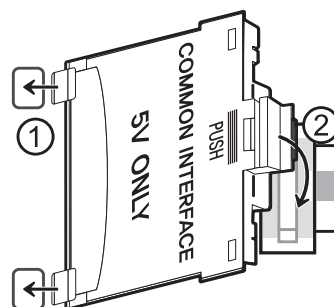

Connecting the “CI or CI+ Card”

Connect the “CI or CI+ Card” to the COMMON INTERFACE slot as shown in the image below.

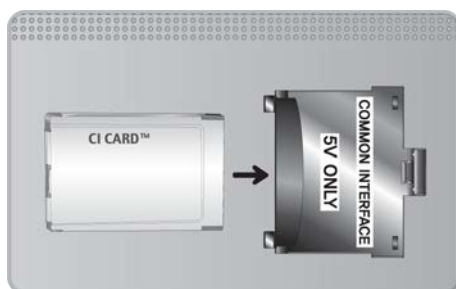

Using the “CI or CI+ Card”

To watch paid channels, the “CI or CI+ CARD” must be inserted.

- Samsung TV follow up CI+ 1.4 standard. When TV product display the pop-up message, it may happen due to CI+ 1.4 Version inconsistency. If you have a problem, please contact Samsung Call Centre.
 - Your Samsung TV conforms to the CI+ 1.4 standards.
 - Where a CI+ Common Interface module is incompatible with this device then please remove the module and contact the CI+ operator for assistance.
- If you don't insert the “CI or CI+ CARD”, some channels will display the pop-up message.
- The pairing information containing a telephone number, the “CI or CI+ CARD” ID, the Host ID, and other information will be displayed in about 2~3 minutes. If an error message is displayed, please contact your service provider.
- When the configuration of channel information has finished, the message “Updating Completed” is displayed, indicating the channel list is updated.
- You must obtain a “CI or CI+ CARD” from a local cable service provider.
- When removing the “CI or CI+ CARD”, carefully pull it out with your hands since dropping the “CI or CI+ CARD” may cause damage to it.
- Insert the “CI or CI+ CARD” in the direction marked on the card.
- The location of the COMMON INTERFACE slot may be different depending on the model.
- “CI or CI+ CARD” is not supported in some countries and regions; check with your authorised dealer.
- If you have any problems, please contact a service provider.
- Insert the "CI or CI+ CARD" that supports the current aerial settings. If not, the screen may not look normal.

08 Setting the Hotel Option Menus

To access the **Hotel Option** menus, press **MUTE > 1 > 1 > 9 > Select** buttons on your remote control.

To control the TV functions in the **Hotel Option** menu, the TV has two modes, the **Standalone** mode and the **Interactive** mode. The menu items that differ between the modes are listed below. All other items appear in both modes.

Menu items in the **Standalone** mode only:

- **SI Vendor:** Movielink / Swisscom / Smoovie / SSCP
- **DRM / Home Menu / REACH Solution / Room Number** and its submenus.

Menu items in the **Interactive** mode only:

- **SI Vendor:** Samsung and other vendors.

After a menu appears, follow these general directions to navigate and change values:

- Use the directional buttons on the remote control to move from menu item to menu item.
- Press the **Select** button on the remote control to select a menu item. The screen displays that menu item only.
- Press the left or right directional button to change a value. The right directional button increases numerical values. The left arrow button decreases numerical values.
- When the screen is displaying one menu item, you can press the up or down directional button to display the next or previous menu item.
- Press the **RETURN** or **MENU** button to exit the current menu item and go to a higher menu level or the main menu.
- To exit a **Hotel Option** menu, turn off the TV, and then turn it on again. Any changes you made are saved except SI (System Integration) vendor. For changes to SI vendor, you must turn the TV off, wait until the power indicator at the bottom of the TV glows steadily. And then unplug the TV, wait for the power indicator to go off, and then plug the TV in again.

To change menus between the **Interactive** mode and the **Standalone** mode, follow the steps below:

1. Highlight the **Hospitality Mode** menu item in the top left corner of the menu.
2. Press the **Select** button on the remote control. Only the **Hospitality Mode** menu item is displayed.
3. Press the left or right directional button to change the **Hospitality Mode** item from **Standalone** to **Interactive** or from **Interactive** to **Standalone**.
4. Press the **RETURN** or **MENU** button on the remote control. The entire menu re-appears with your selection displayed in the **Hospitality Mode** field.
 - After you have set the values in one TV, you can clone those values to multiple TVs.
 - For more information about the USB cloning refer to page 35.

Hotel Option menu items

To enter this menu, press the MUTE > 1 > 1 > 9 > Select  buttons on the remote control in order.

To exit from this menu, turn off (or turn off and unplug the power cable if you have changed SI vendor) the TV, and then turn on again. Any changes you made are saved.

- The menu items may not be supported depending on the models.

Hotel Option menu Item	Description	
Hospitality Mode	Select Hospitality Mode . <ul style="list-style-type: none"> • Interactive: TV works with an SI STB or SBB. • Standalone: TV works alone, without an SI STB or SBB. 	
SI Vendor	<ul style="list-style-type: none"> • Interactive: Samsung / 2M / Locatel / VDA / VDA-S / Acentic / Sustinere / Quadriga / ETV / IBahn / Magilink / Otrum / Siemens / Amino / MDC / Enseio • Standalone: OFF / Movielink / Swisscom / Smoovie / SSCP 	
Power On	Power On Channel	Set the channel to display when the TV is turned on. <ul style="list-style-type: none"> • User Defined: Lets you set the channel number manually on Power On Channel Num. See Power On Channel Num or Power On Channel Type blow. • Last Saved: If you select this item, when the TV is turned on, it displays the channel it was displaying when it was turned off.
	Power On Channel Num	When the TV is turned on, it switches automatically to this channel.
	Power On Channel Type	Select the type of the channel will be displayed when the TV is turned on. ATV (analogue aerial band), DTV (digital aerial band), CATV (analogue cable band), CDTV (digital cable band), SDTV (digital satellite band).
	Power On Volume	<ul style="list-style-type: none"> • User Defined: Lets you set volume level manually. • Last Saved: When the TV is turned on, it returns to the volume that had been set when the power had been turned off.
	Power On Volume Num	The TV turns on with set volume level in Standalone mode.
	Min Volume	The minimum volume level the user can set in Standalone mode.
	Max Voume	The maximum volume level the user can set in Standalone mode.
	Power On Source	Select the input source to display when the TV is turned on.
Power On Option	Determines the TV's state when power returns after a power failure or after you have unplugged the TV and then plugged it in again. <ul style="list-style-type: none"> • Last Option: Returns to its last power state. If it was in standby mode, it returns to standby mode. If it was on, it turns on. • Power ON: When the power returns, the TV turns on. • Standby: When the power returns, the TV enters the standby mode. 	

Hotel Option menu Item	Description	
Channel	Channel Setup	Gives you direct, immediate access to some of the channel menu functions on the Broadcasting menu such as Auto Tuning , Audio Options , etc.
	Channel Editor	<p>Lets you edit the channels stored in the TV's memory.</p> <ul style="list-style-type: none"> • Change the channel numbers and names, manage genre and language groups and delete channels. • Apply the Screen Off to channels you select. The Screen Off blanks out the video from a channel and outputs only audio. • Lets you view information about each channel easily, without your having to display each channel directly.
	Channel Bank Editor	<p>Edits channels, with 3 different Bank options. There are specific channels customers can enjoy, depending on the Bank card.</p> <ul style="list-style-type: none"> • This function is only available when set to Hospitality Mode: Standalone, SI Vendor: Smoovie.
	Mixed Channel Map	<p>Enables showing/browsing all antenna type (Aerial/Cable or Satellite) channels at the same time.</p> <ul style="list-style-type: none"> • ON: When set to on, guests can access the complete channel map irrespective of the selected antenna type. The Channel List/Channel Editor will also populate Aerial as well Cable type channels. • OFF: When set to off, guest can access the channel map corresponding to the selected antenna type (Aerial/Cable or Satellite) only. The Channel List/Channel Editor will only show the selected antenna type channels.
	Dynamic SI	<ul style="list-style-type: none"> • ON: Do not check the DTV programme channel number. • OFF: Check the DTV programme channel number.
	Channel Rescan Message	<p>When there is a mismatch between the data in the channel map and the transmitted data, the TV autotunes the channels to restore the data/parameters in the channel map.</p> <ul style="list-style-type: none"> • ON: When Channel Rescan Message is set to on, the OSD showing that the channels are being rescanned will be displayed to the guest. • OFF: When Channel Rescan Message is set to off, if the rescan message OSD should not be displayed to the guests.
	Pan Euro MHEG	<ul style="list-style-type: none"> • OFF: If Pan Euro MHEG is set to Off, MHEG runs according to the existing product specifications. (E.g. MHEG runs for England, but MHEG does not run for France.) • ON: If Pan Euro MHEG is set to on, MHEG is on regardless of the product specifications or region. (Even if the region does not support MHEG, it is supported in case the hotel supports MHEG.)
	Mychannel	<p>Enable or disable the My Channel function.</p> <ul style="list-style-type: none"> • This function is not available when set to Hospitality Mode: Standalone, SI Vendor: Smoovie.

Hotel Option menu Item		Description
Channel	Subtitle Auto On	<p>This function turns the function on or off that automatically turns on the subtitles in a specific country.</p> <p>This function is supported for the TVs that are ready to receive DVB broadcasts that is heading to Europe.</p> <p>This function is related to France's subtitle specification. The rest of the subtitle functions available according to the country specifications regardless of Subtitle Auto On function.</p> <ul style="list-style-type: none"> • ON: When Subtitle Auto On is set to on, it follows France's subtitle specifications. • OFF: When Subtitle Auto On is set to off, it does not follow France's subtitle specifications.
	TTX Widescreen Mode	<p>ON: TTX should show in 16:9 picture size.</p> <p>OFF: TTX should show in 4:3 picture size.</p>
Menu OSD	Picture Menu Lock	Enable or disable the Picture menu.
	Menu Display	<ul style="list-style-type: none"> • ON: The main menu is displayed. • OFF: The main menu is not displayed.
	Channel Menu Display	<ul style="list-style-type: none"> • OFF: Broadcasting menu is disable for guest. • ON: Broadcasting menu is enable for guest.
	Panel Button Lock	<p>Turning the TV Controller button operations on or off.</p> <ul style="list-style-type: none"> • Unlock: Unlocks TV Controller button. • Lock: Locks TV Controller button. • OnlyPower: Locks TV Controller button except the power off function.
Clock	Local Time	<p>Select the way to update the clock data</p> <ul style="list-style-type: none"> • Standalone: Manual / TTX / Time Channel • Interactive: Manual / Auto / TTX / Time Channel <ul style="list-style-type: none"> – Manual: The clock is set automatically from the DTV channel or manually by the user when the TV is in Standalone mode. – TTX: Bring up the time information from the TTX stream. – Time Channel: The clock is set from the selected channel.
	Timer Type	<p>Enable or disable the alarm function.</p> <ul style="list-style-type: none"> • WakeUp: Enable the alarm function to turn on the device at the specified time. • OnOff: Disable the alarm function and enable on or off timer.
	Time Channel Type	<p>Select the type of the channel to update the clock data.</p> <ul style="list-style-type: none"> • This function is only available Local Time set to Time Channel.
	Time Channel Num	<p>Select the number of the channel to update the clock data.</p> <ul style="list-style-type: none"> • This function is only available Local Time set to Time Channel.

Hotel Option menu Item		Description
Remote Jack Pack	HDMI Option	Select which HDMI source of the TV is connected to the RJP jack. (HDMI1/HDMI2/HDMI3)
	HDMI Music Mode	Allows music output from an mp3/audio player connected to an HDMI input source. When set to on, you can hear sound from the player through an HDMI input of the RJP whether there is a video signal or not. <ul style="list-style-type: none"> This option is only compatible with the Guest link RJP.
External Source	USB Pop-up Screen	When USB is connected to the TV : <ul style="list-style-type: none"> Default: A popup window appears. Automatic: This enters the USB content menu automatically. Disable: Neither the popup window nor the menu appears.
	External Source Banner	If set to on, the TV displays the External Source Banner (information) when you change the TV source to another external input, press the SOURCE button on the remote control, or turn on the TV. <ul style="list-style-type: none"> ON: The External Source Banner (information) is displayed on the TV screen. OFF: The External Source Banner (information) is not displayed on the TV screen.
	Auto Source	<ul style="list-style-type: none"> ON: When an external input source is connected to the TV, the TV identifies the input source, and then automatically switches to that input source. OFF: Auto Source function is disabled.
	Anynet+ Return Source	Select the source to return after stopping an Anynet+ (HDMI-CEC) connection. <ul style="list-style-type: none"> This function is especially useful for the Guestlink RJP.
Eco Solution	Power Saving Mode	Adjusts the brightness of the TV to reduce power consumption. <ul style="list-style-type: none"> OFF: Turns off the energy saving function. Low: Sets the TV to low energy saving mode. Medium: Sets the TV to medium energy saving mode. High: Sets the TV to high energy saving mode.
Logo/ Message	Welcome Message	Displays a the welcome message for 60 seconds when the TV turns on.
	Edit Welcome Message	Edits the welcome message.
	Hospitality Logo	Turns the Hospitality Logo function is set to OFF, BMP, AVI, BOTH . If the function is not set to OFF , the TV is turned on, the logo is displayed, before the signal from the initial source, for the amount of time set in Logo Display Time . <ul style="list-style-type: none"> The DivX codec is not supported.
	Hospitality Logo DL	You can download the startup logo from the connected USB flash drive. Hospitality logo file requirements: <ul style="list-style-type: none"> Image or video files only. The image file is supported up to 2 MB. The video file is supported up to 50 MB. File can only be named "samsung_image.*", "samsung_video.*"
	Logo Display Time	Set the time displayed Hospitality Logo . (3/5/7 seconds).

Hotel Option menu Item		Description
Cloning	Clone TV to USB	Clone the current TV options to a USB memory device.
	Clone USB to TV	Clone the saved TV options on a USB memory device to the TV.
	Setting Auto Initialize	If you set Setting Auto Initialize to On, the TV menu items are restored again to their values cloned initially when the TV turns off and then on.
System Manager		Gives you direct and immediate access to System Manager menu such as such as Time, Language, Change PIN , etc. System Manager allow you to adjust your TV's system and customise settings for your viewing environment.
Security	Factory Lock	Disable entry to Hotel Option menu. <ul style="list-style-type: none"> • ON: The password is needed before entering Hotel Option menu. • OFF: Disable this function.
	Password Popup	Enable or disable password input popup window. If this option is set to off, the TV will not display the password input popup window when entering the Hotel Option menu. If set to on, the password input popup window appears.
	Password Input	If this function is enabled, the password input popup window appears which asks for an 8-character security password. The admin must enter a password before applying or updating security preferences. After the correct password is entered, options such as Password Setting, Password Reset and Security Mode are available.
	Password Setting	User can change the password.
	Password Reset	Password is reset to "00000000".
	Security Mode	Provides password protected administrative functionality to enable or disable features of hospitality TV, such as USB, HDMI . To use this option, Security Mode set to on. After Security Mode set to on, options such as USB, HDMI are automatically enabled. Clone USB to TV and TV Reset will be disabled in the Hotel Option menu.
	USB	Enable or disable USB access. If this function is set to disable, access to USB media is blocked.
	HDMI	Enable or disable HDMI access. If this function is set to disable, Anynet, HDMI source, HDMI type external channels will not be accessible to the user.
DRM	TTX Security	If this option is disabled, the TTX feature will not work when the TTX button is pressed on the remote control.
	DRM Mode	Configures DRM support. <ul style="list-style-type: none"> • OFF: Turns off DRM support. • LYNK DRM: Select to turn on S-LYNK DRM CAS support only.

Hotel Option menu Item		Description
System	Self Diagnosis for TV	Enter Self Diagnosis Menu. <ul style="list-style-type: none"> • Start Picture Test: Use this test when you experience a problem with your TV's picture. • Start Sound Test: Use this test when you experience a problem with your TV's sound. • Signal Information: Show digital broadcasting signal information. • Reset: Restore all TV settings, excluding network settings, to the factory defaults.
	Self Diagnosis for HTV	Lets you check the communication with the SI STB or SBB. If you have any problems with the communications with the SI STB or SBB, use this diagnosis function. If your broadcasting system does not have a problem, contact Samsung Service. If STB SI VendorSetting appears to have failed and communication with the SI STB or SBB has failed, first check your SI STB or SBB. If your SI STB or SBB does not have a problem, contact to Samsung Service.
	Software Update	Lets you upgrade the TV Software with a USB flash dirve.
	Sound Bar Out	If the Samsung Sound Bar device is connected to this TV, this item lets you to select where the TV sound is outputted when the TV is turned on. <ul style="list-style-type: none"> • ON: When the TV is turned on, the TV sound is automatically outputted in the Sound Bar device only. • OFF: When the TV is turned on, the TV sound is automatically outputted in the TV speaker device.
	Contact Samsung	Display the web site of related Samsung service centre, software version, and Mac address information.
	Standby LED	When the TV is in standby mode, you can configure the settings of the power indicator. <ul style="list-style-type: none"> • ON: The LED is on. • OFF: The LED is off.
	Boot Logo	To enable or disable displaying the Samsung logo when the TV turns on.
	TV Reset	Returns all settings on the TV to their factory defaults.
Home Menu	Home Menu Display	Activate Home Menu in Standalone mode for user. <ul style="list-style-type: none"> • ON: Home Menu enabled. • OFF: Home Menu disabled. In Standalone mode, you can quickly access to various features such as Source, Media Play etc and settings such as Picture Size, Language , etc.
	Home Menu Editor	Edit and manage TV functions to be used from Home Menu .
	Home Menu Auto Start	This option allows you to set Home Menu as first screen for user. <ul style="list-style-type: none"> • ON: Home Menu is shown as first screen. • OFF: Do not show Home Menu as first screen.

Hotel Option menu Item		Description
REACH Solution	REACH RF Mode	Turn on or off the REACH RF Mode . When set to on, the TV can operate with the REACH Server (Modulator) through the RF cable.
	REACH Channel	This is a DTV cable channel PTC number for receiving REACH data when the REACH RF Mode set to on. The value must be same as the value set on the REACH Server (Modulator).
	Group ID	You can set the TV's group ID to manage TVs in groups on the REACH Server (Modulator).
	REACH Update Time	You can set the specific time to receive and update REACH data from the REACH Server (Modulator). (Operates when the AC power cord is plugged in and the power is off.) <ul style="list-style-type: none"> • OFF: You can turn off the REACH Update Time function. • 12:00 am: 12:00 am everyday • 2:00 am: 2:00 am everyday • 12:00 pm: 12:00 pm everyday • 2:00 pm: 2:00 pm everyday
	REACH Update Immediate	When set to on, the TV will receive and update REACH data from the REACH Server (Modulator) right after the power is off. (Operates when the AC power cord is plugged in and the power is off.)
	REACH Config Version	Displays the TV configuration data version received from the REACH Server.
Room Number		You can set the room number of the TV's location.

- Refer to the manual of each solution for details about functions and settings of the solutions such as REACH.
- REACH (Remote Enhanced Active Control for Hospitality) is a professional, interactive remote controller that lets you deliver TV firmware updates, cloning data, channel mapping changes, REACH contents, and TICKER contents through RF cable to several hundred hospitality TVs simultaneously. The REACH functions are available only in **Standalone** mode. The REACH Server is sold separately. Refer to the REACH Server manual enclosed with the REACH Server product for more operating information.

Welcome Message

Hotel Option (MUTE > 1 > 1 > 9 > Select ) > Logo/Message > Welcome Message

Welcome Message function displays a custom message on the TV every time it is turned on.

- Set **Welcome Message** to on to display the message when the TV is powered on.
- You can make the welcome message and edit it.
- You can edit the welcome message by using on screen keyboard in the **Edit Welcome Message** (Hotel Option > Logo/Message > Edit Welcome Message).
- Use the directional buttons on the remote control to enter the title and message, and select **Save**.

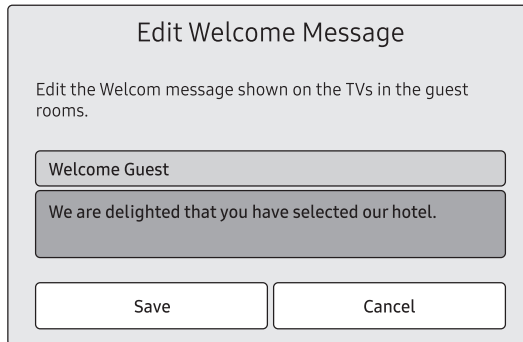

Edit Welcome Message

Edit the Welcom message shown on the TVs in the guest rooms.

Welcome Guest

We are delighted that you have selected our hotel.

Save Cancel

Hotel Logo

Hospitality Logo

Hotel Option (MUTE > 1 > 1 > 9 > Select ) > Logo/Message > Hospitality Logo

Hospitality Logo function displays the Hotel's picture image when the TV is powered on.

- When you set **Hospitality Logo** to AVI / BMP / BOTH, **Hospitality Logo DL** and **Logo Display Time** are enabled.
- If there is a logo image stored in memory and the **Hospitality Logo** is AVI / BMP / BOTH, the logo image is displayed when the TV is turned on.
- The logo image is not displayed when set **Hospitality Logo** to off, even if the logo image has been loaded into the TV.

Logo Download

Hotel Option (MUTE > 1 > 1 > 9 > Select ) > Logo/Message > Hospitality Logo DL

This option lets you download the logo image to the TV's memory from a USB device.

- The wait message appears while the image is being copied to the TV.
- The completed message appears when the copy operation finishes successfully.
- The failed message appears if the copy operation was unsuccessful.
- No USB appears if no USB device is connected.
- If there is no file to copy on the USB device or the file is in the wrong format, the message that there is no file appears.
- If message that there is no file appears and there is a logo file on the USB device, check the file format.
- Logo file format
 - TV Supports all file formats.
 - File name must be "samsnug_image.*" and "samsung_video.*"
 - Maximum file size can be 50MB for Smart models.
 - The TV does not change the size or scale of the image.

USB Cloning



Hotel Option (MUTE > 1 > 1 > 9 > Select ) > Cloning

The USB cloning function lets you download user-configured settings (Picture, Sound, Channel, and Hotel Option) from one TV to a USB device, and then upload these settings from the USB device to other TV sets. This lets you create a standard file of settings and distribute that standard file to all the TVs in your facility.

- After cloning, certain features are applied when the TV is turned on again.

Cloning TV to USB: Copies stored menu settings from a TV to a USB device

Hotel Option (MUTE > 1 > 1 > 9 > Select ) > Cloning > Clone TV to USB

1. Insert a USB drive into the USB port on the rear of the TV.
2. Enter the **Hotel Option** menu by pressing buttons in order. (MUTE > 1 > 1 > 9 > Select )
3. Press the up or down directional button to select **Clone TV to USB**, and press the **Select**  button on the remote control.
4. When the message **Clone TV to USB** is displayed. Press the **Select**  button on the remote control.
 - The clone folder will be labelled T-KTM2DEUCB.
 - The cloned values include the values on the guest side menu (Brightness, Picture Size, Contrast, etc.) and the **Hotel Option** menu.

Cloning USB to TV: Copies menu settings and channel data in a USB device to a TV

Shortcut: Turn the TV off, insert the USB device, turn the TV on, and then press the **Select** button on the remote control for 5 seconds.

To clone data to the TV using the Hotel menu, follow these steps:

1. Turn the TV off.
2. Insert the USB drive into the USB port on the rear of the TV.
3. Turn the TV on.
4. Enter the **Hotel Option** menu by pressing buttons in order. (**MUTE** > **1** > **1** > **9** > **Select** button)
5. Press the up or down directional button to select **Clone USB to TV**, and press the **Select** button on the remote control.
6. The message **Clone USB to TV** is displayed. Press the **Select** button on the remote control.
 - If there is no file to copy on the USB device or the message that there is no file appears, check the folder on your USB device.
 - The folder name should be **T-KTM2DEUCB**.
 - Tables that list the settings that are cloned in the **Hotel Option** menu begin on the next page.

Pre-condition for cloning (check point)

- Cloning should be done between same model (same version).
- Before cloning, all displays should be updated at the latest version (same version).

Settings Cloned in the Hotel Menu

- The menu items may not be supported depending on the models.

Menu Item	Sub Item	Cloned or not	
Hospitality Mode	Standalone / Interactive	Yes	
SI Vendor	Interactive mode : Samsung / 2M / Locatel / VDA / VDA-S / Acentic / Sustinere / Quadriga / ETV / IBahn / Magilink / Otrum / Siemens / Amino / MDC / Enseo Standalone mode : OFF / Movielink / Swisscom / Smoovie / SSCP	Yes	
Power On	Power On Channel	User Defined / Last Saved	Yes
	Power On Channel Num	***	Yes
	Power On Channel Type	ATV / DTV / CATV / CDTV / SDTV	Yes
	Power On Volume	User Defined / Last Saved	Yes
	Power On Volume Num	0~100	Yes
	Min Volume	0~100	Yes
	Max Volume	0~100	Yes
	Power On Source	TV / HDMI1 / HDMI2 / HDMI3 / Last Saved	Yes
Power On Option	Power On / Standby / Last Option	Yes	
Channel	Channel Setup	—	No
	Channel Editor	—	No
	Channel Bank Editor	—	No
	Mixed Channel Map	ON / OFF	Yes
	Dynamic SI	ON / OFF	Yes
	Channel Rescan Message	ON / OFF	Yes
	Pan Euro MHEG	ON / OFF	Yes
	MyChannel	ON / OFF	Yes
	Subtitle Auto On	ON / OFF	Yes
	TTX Widescreen Mode	ON / OFF	Yes
Menu OSD	Picture Menu Lock	ON / OFF	Yes
	Menu Display	ON / OFF	Yes
	Channel Menu Display	ON / OFF	Yes
	Panel Button Lock	Unlock / Lock / OnlyPower	Yes
Clock	Local Time	Standalone: Manual / TTX / Time Channel Interactive: Manual / Auto / TTX / Time Channel	Yes
	Timer Type	WakeUp / OnOff	Yes
	Time Channel Type	DTV / CDTV	Yes
	Time Channel Num	***	

Menu Item		Sub Item	Cloned or not
Remote Jack Pack	HDMI Option	HDMI1 / HDMI2 / HDMI3	Yes
	HDMI Music Mode	ON / OFF	Yes
External Source	USB Pop-up Screen	Default / Automatic / Disable	Yes
	External Source Banner	ON / OFF	Yes
	Auto Source	ON / OFF	Yes
	Anynet+Return Source	Power On Src / Last Source / Each model source list (TV, HDMI1, HDMI2, etc.)	Yes
Eco Solution	Power Saving Mode	OFF / Low / Medium / High	Yes
Logo / Message	Welcome Message	ON / OFF	Yes
	Edit Welcome Message	—	Yes
	Hospitality Logo	OFF / BMP / AVI / BOTH	Yes
	Hospitality Logo DL	—	Yes
	Logo Display Time	3 second / 5 second / 7 second	Yes
Cloning	Clone TV to USB	—	No
	Clone USB to TV	—	No
	Setting Auto Intialize	ON / OFF	Yes
System Manager		—	No
Security	FactoryLock	ON / OFF	Yes
	Password Popup	ON / OFF	Yes
	Password Input	—	No
	Password Setting	—	Yes
	Password Reset	—	No
	Security Mode	ON / OFF	Yes
	USB	Enable / Disable	Yes
	HDMI	Enable / Disable	Yes
	TTX Security	Enable / Disable	Yes
DRM	DRM Mode	OFF / LYNKDRM	Yes

Menu Item		Sub Item	Cloned or not	
System	Self Diagnosis for TV		—	No
	Self Diagnosis for HTV	STB SI Vendor Setting	Si Name Sucess / Failure	No
		RTC	Sucess / Failure	
	Software Update		—	No
	Sound Bar Out		ON / OFF	Yes
	Contact Samsung		—	No
	Standby LED		ON / OFF	Yes
	Boot Logo		ON / OFF	Yes
TV Reset		—	No	
Home Menu	Home Menu Display		ON / OFF	Yes
	Home Menu Editor		—	Yes
	Home Menu Auto Start		ON / OFF	Yes
REACH Solution	REACH RF Mode		ON / OFF	Yes
	REACH Channel		***	Yes
	Group ID		ALL, 1 - 511	No
	REACH Update Time		OFF / 12:00 am / 2:00 am / 12:00 pm / 2:00 pm	Yes
	REACH Update Immediate		ON / OFF	Yes
	REACH Config Version		—	No
Room Number		—	No	

Setting Auto Initialise

Hotel Option (MUTE > 1 > 1 > 9 > Select ) > Cloning > Setting Auto Initialize

When you clone settings from one TV to another, you clone both the guest side menu and hotel side menu settings: **Picture, Sound, Channel, and Hotel Option** menu. This lets you set nearly all of the menu values on your hospitality TVs to the same, standard settings. If you allow guests access to the guest side menus, for example the **Picture** menu, they can change the settings in those menus so they are no longer standard. If you set the **Setting Auto Initialize** function to on the TV automatically restores (initialises) any guest-side menu values to the cloned, standard values when the TV is turned off and then turned on again. Note that **Setting Auto Initialize** works on cloned guest side menu values only. Settings which have not been cloned are ignored.

The table below lists the settings that are restored to their cloned values when you set the **Setting Auto Initialize** function to on.

- The menu items may not be supported depending on the models.

Menu Item				
Picture	Picture Mode			
	Picture Size Settings	Picture Size		
		Auto Wide		
		4:3 Screen Size		
		Fit to screen		
		Zoom and Position		
	Expert Settings	Backlight		
		Brightness		
		Contrast		
		Sharpness		
		Colour		
		Tint (G/R)		
		Apply Picture Settings		
		Digital Clean View		
		Auto Motion Plus Settings	Auto Motion Plus	
			Judder Reduction	
			LED Clear Motion	
		Contrast Enhancer		
		HDR+ Mode		
	Film Mode			
Colour Tone				

Menu Item					
Picture	Expert Settings	White Balance	2 Point	R-Gain	
				G-Gain	
				B-Gain	
				R-Offset	
			G-Offset		
			B-Offset		
			20 Point Settings	20 Point	
				Interval	
		Red			
		Green			
					Blue
			Gamma		
			HLG		
			ST.2084		
			BT.1886		
			RGB Only Mode		
	Colour Space Settings	Colour Space			
		Colour			
		Red			
		Green			
		Blue			
Sound	Sound Output				
	Sound Mode				
	Expert Settings	Balance			
		Equaliser			
		HDMI Input Audio Format			
		Digital Output Audio Format			
		Audio Delay			
		Auto Volume			
	Sound Feedback				

Menu Item					
Broadcasting	Expert Settings	Teletext Language Settings	Teletext Language		
			Primary Teletext Language		
			Secondary Teletext Language		
		Audio Options	Primary Audio Language		
Secondary Audio Language					
General	System Manager	Time	Clock	Clock Mode	
				Time Zone	
				DST	
				GMT	
	Language				
	Auto Protection Time				
	External Device Manager	Anynet+ (HDMI-CEC)			
		Game Mode			
		HDMI UHD Color			
		HDMI Black Level			
		Input Device Manager	Keyboard Language		
	Keyboard type				
	Eco Solution	Ambient Light Detection			
		Minimum Backlight			
		Energy Saving Mode			
		Motion Lighting			
		Auto Power Off			
	Accessibility	Audio Description Settings	Audio Description		
			Audio Description Volume		
		High Contrast			
Greyscale					
Enlarge					



Updating the TV's Software

DO NOT turn off the TV's power until the update is complete. The TV will turn off and on automatically after completing the software update. Video and audio settings will be reset to their defaults after a software update. We recommend you clone the TV's settings so that you can easily reset them after the upgrade.

- For more information about the USB cloning function, refer to page 35.

Updating through a USB device

To update the TV's software, follow these steps:

1. Insert a USB flash drive containing the software update file into the USB port of the TV.
 2. Run **Update Now**. (MENU  > Support > Software Update > Update Now)
 3. The TV displays a pop-up message that checks for the updated version.
 4. Move the focus to **OK**, and then press the **Select**  button on the remote control.
- Please be careful to not disconnect the power or remove the USB flash drive while upgrades are being applied. The TV will turn off and turn on automatically after completing the SW upgrade. Please check the SW version after the upgrades are complete.

09 Using a Multi Code Remocon

A Multi Code Remocon is a special remote which is designed to control multiple TVs. This function is useful where there is more than one TV in a location.

You can control up to 10 TVs with a different ID code of each remote with no conflicts between the TVs. ID numbers are displayed on each TV's OSD.

The Initial ID code for each TV is **0**.

- You can set and reset the ID code in analogue TV mode or PC mode. (Not available in DTV mode.)
- You can set the ID code to any digit from **0** to **9**.
- To set a TV's ID code, follow these steps:
 1. Aim the remote at the TV, and then press the **MUTE** button and the **RETURN** button simultaneously for more than 7 seconds. When you stop pressing the buttons, the TV displays the current ID in the middle of the screen and a message appears.
 2. Press the number on the remote you want to assign to the TV. The TV displays a message.
 3. After you see the message, if you press **1**, the TV and Remote will be set to ID code **1**.
 - The TV can then only be controlled by a remote which has the same ID code **1**.
 - To reset the ID code, press the **MUTE** button and the **EXIT** button simultaneously for more than 7 seconds. When you stop pressing the buttons, the ID codes of the TV and Remote are reset to **0**.

10 Setting the Soundbar

Samsung Soundbar (AirTrack) and Hospitality TVs in 2018

- Samsung Soundbar (AirTrack) and hospitality TVs support the HDMI ARC feature. If you connect a compatible Samsung Soundbar (AirTrack) to a compatible Samsung hospitality TV using a single HDMI cable, guests can listen to the TV's sound through the Soundbar (AirTrack).
- **Sound bar Out** in **Hotel Option** menu makes you control to where the TV sound is outputted when the TV is turned on.
 - **Hotel Option (MUTE > 1 > 1 > 9 > Select [OK]) > System > Sound Bar Out**
- If **Sound bar Out** set to on, the TV sound is automatically outputted in the Soundbar (AirTrack) device only whenever TV is turned on.
- If **Sound bar Out** set to off, the TV sound is automatically outputted in the TV speaker only whenever TV is turned on.
- Models supporting the ARC function are listed below:
 - HW-M550/M500/M4500
 - HW-N650/N550/N450

Setting the Soundbar (AirTrack) to Hotel Mode

1. Set the following options in **Hotel Option (MUTE > 1 > 1 > 9 > Select [OK])**:
 - **System > Sound Bar Out > ON**
 - **Power On > Power On Volume > User Defined**
 - **Power On > Power On Volume Num > set greater than 0**
 - **Power On > Max Volume > set greater than 0**
2. Connect an HDMI cable from the HDMI out port of the Soundbar (AirTrack) to the HDMI port (supporting ARC) on the TV.
3. After the Soundbar (AirTrack) is connected to the TV, when the TV turns on, the Soundbar (AirTrack) automatically detects the TV, and then automatically switches to Hotel Mode.

Soundbar (AirTrack) features in Hotel mode



- Power on / off is synchronised with the TV.
- HDMI-CEC defaults set to on
- Available only through the HDMI out port.
- Disables the "Input mode" key on the VFD to prevent unexpected audio-source changes.
- Acquires adjustable **Power On** and **Max Volume** settings from the TV's **Hotel Option** menu. However Soundbar's **Power On Volume** and **Max Volume** values are set to half of **Power On Volume** and **Max Volume** settings in the TV's **Hotel Option** menu.
 - If the TV's **Power On Volume** = 20 and **Max Volume** = 90, then Soundbar's **Power On Volume** = 10 and **Max Volume** = 45.
- To use **Voice Guide** while an external device is connected to the **DIGITAL AUDIO OUT (OPTICAL)** or **HDMI IN (ARC)** terminal, be sure to select **PCM** at **MENU [OK] > Sound > Expert Settings > Digital Output Audio Format**.

11 Editing Channels

Channel Bank Editor (Smovie TV Only)

Channel Bank Editor in conjunction with the SMOOVIE remote lets you control the channels guests have access to. Channel Bank Editor provides three Banks of channels and lets you select which channels will be available from each bank. SMOOVIE remotes have installable Bank Cards which correspond to the channel banks in the Channel Bank Editor. The remotes only allow access to channels in the channel bank that correspond to the installed card. Consequently, the channels a guest can access depend on the Bank Card installed in their SMOOVIE remote.

Setting the Channel Bank Editor under Standalone Mode

1. Press MUTE > 1 > 1 > 9 > Select  buttons on the remote control to enter the Hotel Option menu.
2. Go to SI vendor, and then select Smovie.
3. Go to Channel > Channel Bank Editor. Press the Select  button on the remote control.
4. Enter the Channel Bank Editor. Edit the Channel Bank.
 - Bank1 (Free channel): Select the channels that will be accessible when a remote doesn't have a card.
 - Bank2 (Family Card - Green): Select the channels that will be accessible when a remote has a GREEN CARD.
 - Bank3 (Adult Card - Red): Select the channels that will be accessible when a remote has a RED CARD.

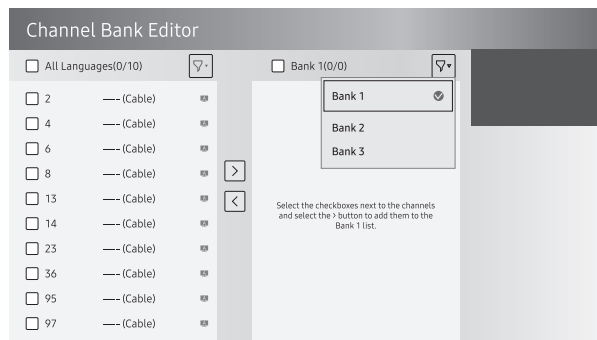

Information About SMOOVIE Remote Controls

- If you select SMOOVIE as the SI vendor, you should also use SMOOVIE remotes in your facility.
- Guests with remotes that do not have a card can only view channels from Bank 1.
- Guests using the numeric button on the remote control to change channels can only view channels from Bank 1.
- Guests with remotes that have Green or Red cards must use the channel up or down directional buttons to change channels.
- Guests can only see channels from the Bank 1 channel list in the Guide or the Channel List.

Smooovie Set Up Sequence

1. Complete the Initial Setup.
2. The TV displays the **Hotel Option** menu.
 - If the Initial Setup is already done, enter the **Hotel Option** menu. (MUTE > 1 > 1 > 9 > Select [EXIT])
3. Select the channel type. (Power On > Power On Channel Type)
 - ATV or ADTV for Aerial
 - CATV or CDTV for cable
4. Select **Smooovie** in the **SI Vendor** menu.
5. Select **Channel Setup** (Channel > Channel Setup).
6. Select **Terrestrial** or **Cable** to auto tune.
7. Set up channels in the **Channel Bank Editor** (Channel > Channel Bank Editor).
8. Turn off the TV, and then turn it on again. Then guests can use the TV.

Using Channel Editor

Hotel Option (MUTE > 1 > 1 > 9 > Select [EXIT]) > **Channel** > **Channel Editor**

Using **Channel Editor** you can edit the channels stored in the TV's memory.

- Change the channel numbers and names, edit the channel language and channel genre and delete channels.
 - This function is enabled when **My Channel** set to **On** in **Hotel Option** menu. (**Hotel Option** (MUTE > 1 > 1 > 9 > Select [EXIT]) > **Channel** > **My Channel**)
- Apply the **Screen Off** to channels you select. The **Screen Off** blanks out the video from a channel and outputs only the sound while displaying a screen off icon on the screen.
- **Channel Editor** also lets you view information about each channel easily, without your having to display each channel directly.

General Steps for Using the Channel Editor in Standalone Mode

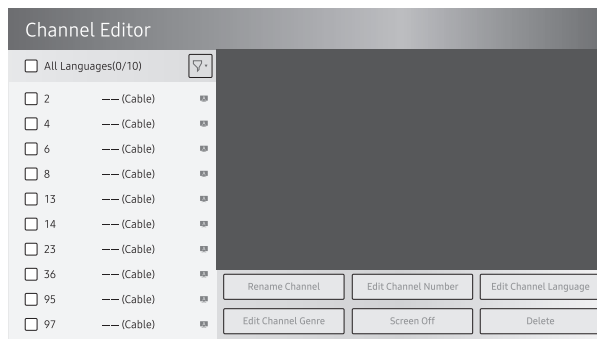

1. Run **Channel Setup** (Channel > Channel Setup) in the **Hotel Option** menu.
2. Enter **Channel Editor** (Channel > Channel Editor) in the **Hotel Option** menu.
3. On a piece of paper, compile a list of channels you want to have, arranged in the order you want.
4. Based on the list created in Step 3, rearrange the channels and edit the channel names.
5. Press the **EXIT** or **RETURN** button to exit.

Editing the Channel Number

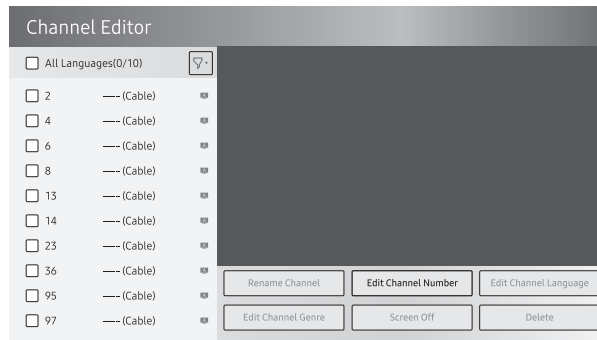

Change the channel number of a channel you select. To change a channel number, follow these steps:

1. Select a channel on the **Channel Edit** screen.
2. Use the directional buttons on the remote control, move the focus to **Edit Channel Number**, and **Select** button.
3. Use the up or down directional buttons on the remote control to change the channel number.
4. Select **OK** when done, and then press the **Select** button on the remote control.
 - When you change the channel number, the channel information is updated automatically.

Rename the Channel



Change the name of a channel you select. To change the name of a channel, follow these steps:

1. Select a channel on the **Channel Edit** screen.
2. Use the directional buttons on the remote control, move the focus to **Rename channel**, and **Select** button.
3. Use the on-screen keyboard that appears to enter the new name for the channel. Use the directional buttons on the remote control, select a letter or number, and then press **Select** button. Repeat for each letter or number you want to select.
4. When finished, select **Done** on the bottom of the screen, and then press the **Select** button on the remote control.

Assigning the Channel Number to the external device

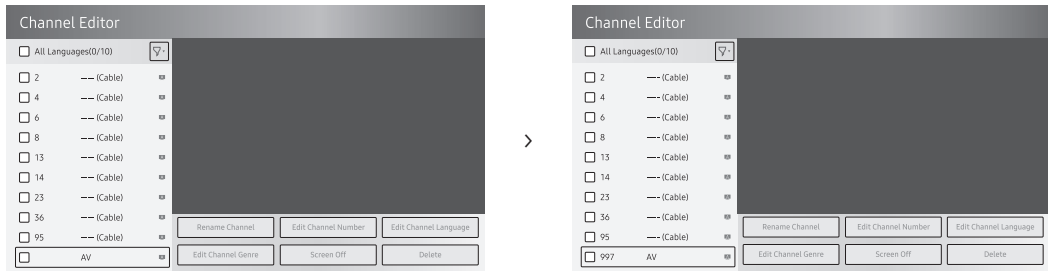
The external device source of the TV are displayed in the last page of the **Channel Editor** menu as shown below.





1. Select a external device source on the **Channel Edit** screen.
 2. Use the directional buttons on the remote control, move the focus to **Edit Channel Number**, and **Select**  button.
 3. Use the up or down directional buttons on the remote control to assign the channel number.
 4. Select **OK** when done, and then press the **Select**  button on the remote control.
- Once you assign a channel number to an external device, you can enter the external device without opening the TV source menu.

12 Anti-theft Kensington Lock

The Kensington Lock is a device you can use to physically fix a TV to a location when you use it in a public place. The appearance and locking method may differ from the illustration at right, depending on the manufacturer. Refer to the manual provided with the Kensington Lock for additional information on proper use.

- The Kensington Lock slot is only available on the HG43EJ670U model.

The Kensington Lock is not supplied by Samsung.

- Please find the  icon on the rear of the TV. A Kensington slot is beside the  icon.

To lock the product, follow these steps:

1. Wrap the Kensington lock cable around a large, stationary object such as desk or chair.
 2. Slide the end of the cable with the lock attached through the looped end of the Kensington lock cable.
 3. Insert the locking device into the Kensington slot on the product **1**.
 4. Lock the lock.
- These are general instructions. For exact instructions, see the User manual supplied with the locking device.
 - The locking device has to be purchased separately.
 - The location of the Kensington slot may be different depending on the TV model.

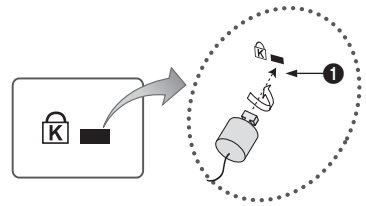

13 Specifications and Other Information

Specifications

Model Name	HG43EJ670U	HG49EJ670U
Display Resolution	3840 x 2160	3840 x 2160
Screen Size (Diagonal)	43 inches (108 cm)	49 inches (123 cm)
Sound (Output)	20 W	20 W
Stand Swivel (Left / Right)	20° / 60° / 90°	20° / 60° / 90°
Dimensions (W x H x D)		
Body	970.2 x 563.2 x 58.8 mm	1102.8 x 637.8 x 59.7 mm
With stand	970.2 x 618.1 x 226.5 mm	1102.8 x 691.8 x 226.5 mm
Weight		
Without Stand	9.6 kg	13.2 kg
With Stand	12.7 kg	16.4 kg
Model Name	HG55EJ670U	
Display Resolution	3840 x 2160	
Screen Size (Diagonal)	55 inches (138 cm)	
Sound (Output)	20 W	
Stand Swivel (Left / Right)	20° / 60° / 90°	
Dimensions (W x H x D)		
Body	1238.6 x 714.2 x 59.2 mm	
With stand	1238.6 x 768.4 x 226.5 mm	
Weight		
Without Stand	17.3 kg	
With Stand	20.5 kg	

Environmental Considerations

Operating Temperature	10°C to 40°C (50°F to 104°F)
Operating Humidity	10% to 80%, non-condensing
Storage Temperature	-20°C to 45°C (-4°F to 113°F)
Storage Humidity	5% to 95%, non-condensing

Notes

- The design and specifications are subject to change without prior notice.
- For information about the power supply, and more information about power consumption, refer to the label-rating attached to the product.
- You can see the label-rating attached to the back of the TV. (For some models, you can see the label-rating inside the cover terminal.)
- Typical power consumption is measured according to IEC 62087.

Decreasing power consumption

When you shut the TV off, it enters Standby mode. In Standby mode, it continues to draw a small amount of power. To decrease power consumption, unplug the power cord when you don't intend to use the TV for a long time.

Supported Resolutions for UHD Input Signals

- Resolution: 3840 x 2160p, 4096 x 2160p
 - An HDMI connection with HDMI UHD Color set to Off supports up to UHD 50P/60P 4:2:0 input signals, while an HDMI connection with HDMI UHD Color set to On supports up to UHD 50P/60P 4:4:4 and 4:2:2 input signals.
 - MENU > General > External Device Manager > HDMI UHD Color

If HDMI UHD Color is set to Off

Frame rate (fps)	RGB	YCbCr 4:4:4	YCbCr 4:2:2	YCbCr 4:2:0
24 / 25 / 30	0	0	0	-
50 / 60	-	-	-	0

If HDMI UHD Color is set to On

Frame rate (fps)	RGB	YCbCr 4:4:4	YCbCr 4:2:2	YCbCr 4:2:0
24 / 25 / 30	0	0	0	-
50 / 60	0	0	0	0

Display Resolution

When you use your TV as a computer monitor, you can also select one of the standard resolutions listed in the Resolution column. The TV will automatically adjust to the resolution you choose.

Mode	Resolution	Display format	Horizontal frequency (KHz)	Vertical frequency (Hz)	Clock frequency (MHz)	Polarity (horizontal / vertical)
IBM	720 x 400	70 Hz	31.469	70.087	28.322	-/+
MAC	640 x 480	67 Hz	35.000	66.667	30.240	-/-
	832 x 624	75 Hz	49.726	74.551	57.284	-/-
	1152 x 870	75 Hz	68.681	75.062	100.000	-/-
VESA DMT	640 x 480	60 Hz	31.469	59.940	25.175	-/-
	640 x 480	72 Hz	37.861	72.809	31.500	-/-
	640 x 480	75 Hz	37.500	75.000	31.500	-/-
	800 x 600	60 Hz	37.879	60.317	40.000	+/+
	800 x 600	72 Hz	48.077	72.188	50.000	+/+
	800 x 600	75 Hz	46.875	75.000	49.500	+/+
	1024 x 768	60 Hz	48.363	60.004	65.000	-/-
	1024 x 768	70 Hz	56.476	70.069	75.000	-/-
	1024 x 768	75 Hz	60.023	75.029	78.750	+/+
	1152 x 864	75 Hz	67.500	75.000	108.000	+/+
	1280 x 720	60 Hz	45.000	60.000	74.250	+/+
	1280 x 800	60 Hz	49.702	59.810	83.500	-/+
	1280 x 1024	60 Hz	63.981	60.020	108.000	+/+
	1280 x 1024	75 Hz	79.976	75.025	135.000	+/+
	1366 x 768	60 Hz	47.712	59.790	85.500	+/+
	1440 x 900	60 Hz	55.935	59.887	106.500	-/+
	1600 x 900RB	60 Hz	60.000	60.000	108.000	+/+
1680 x 1050	60 Hz	65.290	59.954	146.250	-/+	
1920 x 1080	60 Hz	67.500	60.000	148.500	+/+	
1920 x 1200	60 Hz	74.556	59.885	193.250	-/+	

Mode	Resolution	Display format	Horizontal frequency (KHz)	Vertical frequency (Hz)	Clock frequency (MHz)	Polarity (horizontal / vertical)
CEA-861	720(1440) x 576i	50 Hz	15.625	50.000	27.000	- / -
	720(1440) x 480i	60 Hz	15.734	59.940	27.000	- / -
	720 x 576	50 Hz	31.250	50.000	27.000	- / -
	720 x 480	60 Hz	31.469	59.940	27.000	- / -
	1280 x 720	50 Hz	37.500	50.000	74.250	+ / +
	1280 x 720	60 Hz	45.000	60.000	74.250	+ / +
	1920 x 1080i	50 Hz	28.125	50.000	74.250	+ / +
	1920 x 1080i	60 Hz	33.750	60.000	74.250	+ / +
	1920 x 1080	24 Hz	27.000	24.000	74.250	+ / +
	1920 x 1080	25 Hz	28.125	25.000	74.250	+ / +
	1920 x 1080	30 Hz	33.750	30.000	74.250	+ / +
	1920 x 1080	50 Hz	56.250	50.000	148.500	+ / +
	1920 x 1080	60 Hz	67.500	60.000	148.500	+ / +
	3840 x 2160	24 Hz	54.000	24.000	297.000	+ / +
	3840 x 2160	25 Hz	56.250	25.000	297.000	+ / +
	3840 x 2160	30 Hz	67.500	30.000	297.000	+ / +
	3840 x 2160	50 Hz	112.500	50.000	594.000	+ / +
	3840 x 2160	60 Hz	135.000	60.000	594.000	+ / +
	4096 x 2160	24 Hz	54.000	24.000	297.000	+ / +
	4096 x 2160	25 Hz	56.250	25.000	297.000	+ / +
4096 x 2160	30 Hz	67.500	30.000	297.000	+ / +	
4096 x 2160	50 Hz	112.500	50.000	594.000	+ / +	
4096 x 2160	60 Hz	135.000	60.000	594.000	+ / +	
HDMI	3840 x 2160	30 Hz	67.500	30.000	297.000	+ / +
	3840 x 2160	25 Hz	56.250	25.000	297.000	+ / +
	3840 x 2160	24 Hz	54.000	24.000	297.000	+ / +
	4096 x 2160	24 Hz	54.000	24.000	297.000	+ / +

- The interlaced mode is not supported.
- The set might operate abnormally if you select a non-standard video format.
- Separate and Composite modes are supported. SOG (Sync On Green) is not supported.

Dimensions

Front view / Side view

The displayed image may differ from your TV, depending on the model.

- 43"

(Unit: mm)

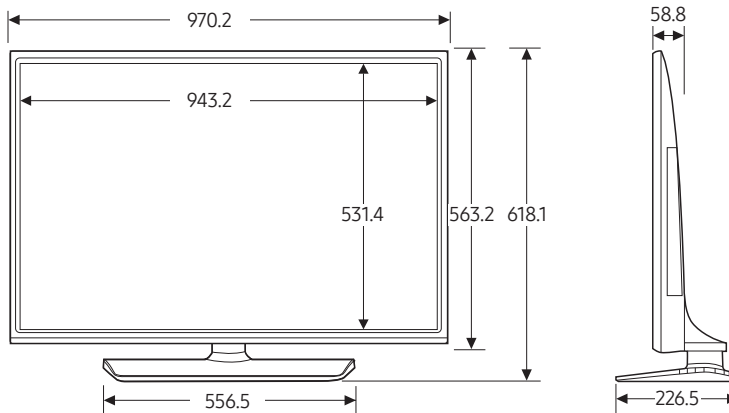

- 49"

(Unit: mm)

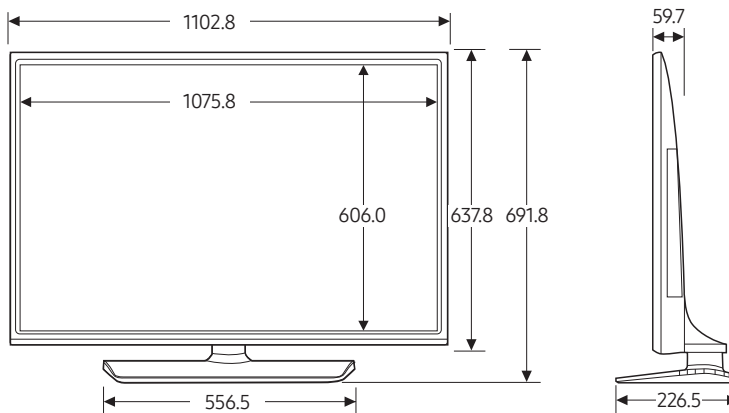

- 55"

(Unit: mm)

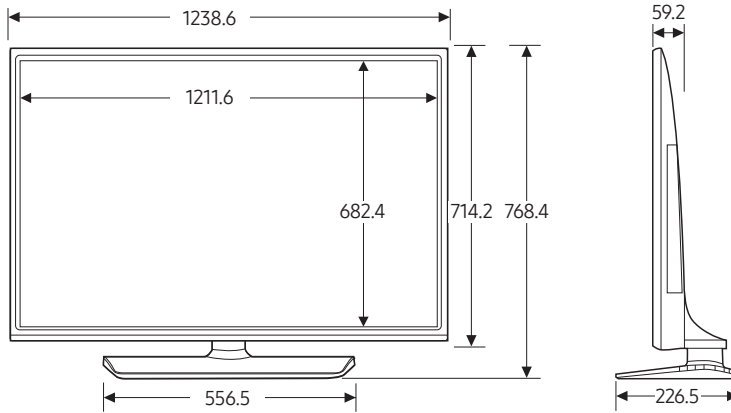

Jack panel detail / Rear view

Detailed dimensions can be checked at Displaysolutions.samsung.com.

Base Stand detail

The displayed image may differ from your TV, depending on the model.

- 43"

(Unit: mm)

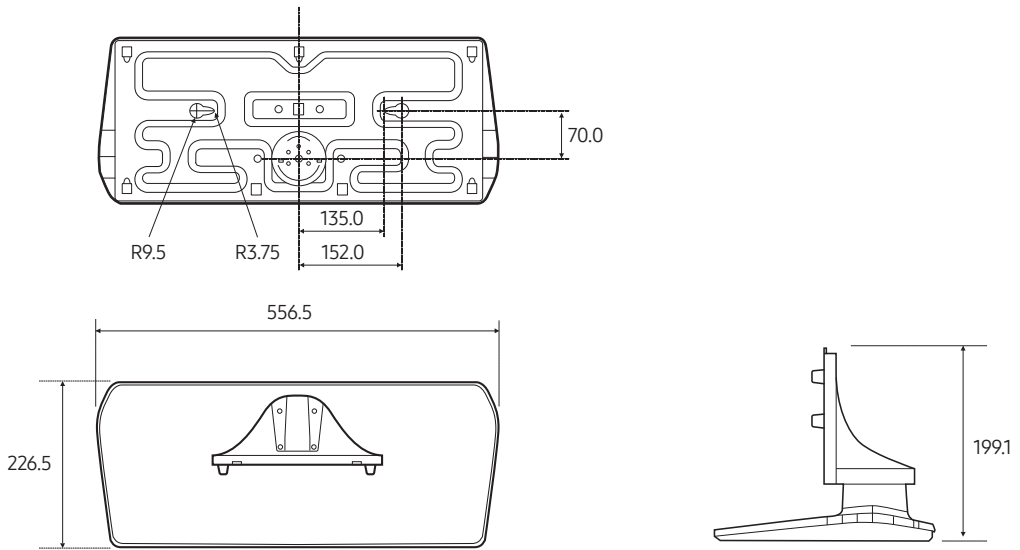

- 49"-55"

(Unit: mm)

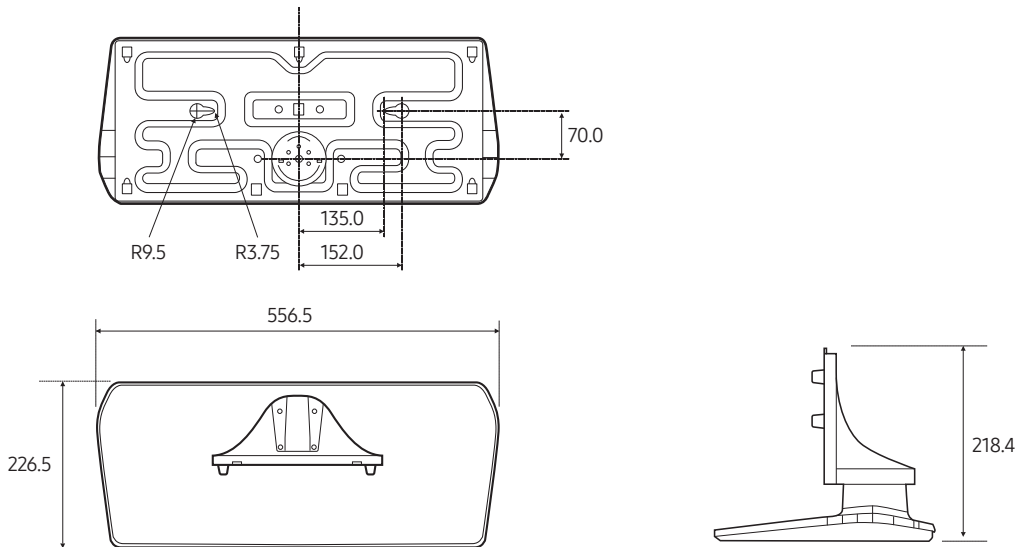

- **NOTE:** All drawings are not necessarily to scale. Some dimensions are subject to change without prior notice. Refer to the dimensions prior to performing installation of your TV. Not responsible for typographical or printed errors.

Licences



Manufactured under license from Dolby Laboratories. Dolby, Dolby Audio, Pro Logic, and the double-D symbol are trademarks of Dolby Laboratories.



THIS PRODUCT IS SOLD WITH A LIMITED LICENCE AND IS AUTHORISED TO BE USED ONLY IN CONNECTION WITH HEVC CONTENT THAT MEETS EACH OF THE THREE FOLLOWING QUALIFICATIONS: (1) HEVC CONTENT ONLY FOR PERSONAL USE; (2) HEVC CONTENT THAT IS NOT OFFERED FOR SALE; AND (3) HEVC CONTENT THAT IS CREATED BY THE OWNER OF THE PRODUCT.

THIS PRODUCT MAY NOT BE USED IN CONNECTION WITH HEVC ENCODED CONTENT CREATED BY A THIRD PARTY, WHICH THE USER HAS ORDERED OR PURCHASED FROM A THIRD PARTY, UNLESS THE USER IS SEPARATELY GRANTED RIGHTS TO USE THE PRODUCT WITH SUCH CONTENT BY A LICENSED SELLER OF THE CONTENT.

YOUR USE OF THIS PRODUCT IN CONNECTION WITH HEVC ENCODED CONTENT IS DEEMED ACCEPTANCE OF THE LIMITED AUTHORITY TO USE AS NOTED ABOVE.



The terms HDMI and HDMI High-Definition Multimedia Interface, and the HDMI Logo are trademarks or registered trademarks of HDMI Licensing LLC in the United States and other countries.

Open Source License Notice

Open Source used in this product can be found on the following webpage. (<http://opensource.samsung.com>)

Open Source License Notice is written only English.

SAMSUNG

Contact SAMSUNG WORLD WIDE

If you have any questions or comments relating to Samsung products, please contact the SAMSUNG customer care centre.

Country	Customer Care Centre ☎	Web Site
AUSTRIA	0800-SAMSUNG (0800-7267864) [Only for Dealers] 0810-112233	www.samsung.com/at/support
BELGIUM	02-201-24-18	www.samsung.com/be/support (Dutch) www.samsung.com/be_fr/support (French)
BOSNIA	055 233 999	www.samsung.com/support
ALBANIA	045 620 202	www.samsung.com/al/support
BULGARIA	*3000 Цена в мрежата 0800 111 31, Безплатна телефонна линия	www.samsung.com/bg/support
CROATIA	072 726 786	www.samsung.com/hr/support
CZECH	800 - SAMSUNG (800-726786) Samsung Electronics Czech and Slovak, s.r.o. V Parku 2323/14, 148 00 - Praha 4	www.samsung.com/cz/support
DENMARK	707 019 70	www.samsung.com/dk/support
FINLAND	030-6227 515	www.samsung.com/fi/support
FRANCE	01 48 63 00 00	www.samsung.com/fr/support
GERMANY	06196 77 555 77	www.samsung.com/de/support
CYPRUS	8009 4000 only from landline, toll free	
GREECE	80111-SAMSUNG (80111 726 7864) only from land line (+30) 210 6897691 from mobile and land line	www.samsung.com/gr/support
HUNGARY	0680SAMSUNG (0680-726-7864)	www.samsung.com/hu/support
ITALIA	800-SAMSUNG (800.7267864)	www.samsung.com/it/support
LUXEMBURG	261 03 710	www.samsung.com/be_fr/support
MONTENEGRO	020 405 888	www.samsung.com/support
SLOVENIA	080 697 267 (brezplačna številka)	www.samsung.com/si/support
NETHERLANDS	088 90 90 100	www.samsung.com/nl/support
NORWAY	815 56480	www.samsung.com/no/support
POLAND	801-172-678* lub +48 22 607-93-33* * (koszt połączenia według taryfy operatora)	www.samsung.com/pl/support
PORTUGAL	808 207 267	www.samsung.com/pt/support
ROMANIA	*8000 (apel in retea) 08008-726-78-64 (08008-SAMSUNG) Apel GRATUIT	www.samsung.com/ro/support
SERBIA	011 321 6899	www.samsung.com/rs/support
SLOVAKIA	0800 - SAMSUNG (0800-726 786)	www.samsung.com/sk/support
SPAIN	0034902172678	www.samsung.com/es/support
SWEDEN	0771 726 786	www.samsung.com/se/support
SWITZERLAND	0800 726 78 64 (0800-SAMSUNG)	www.samsung.com/ch/support (German) www.samsung.com/ch_fr/support (French)
UK	0330 SAMSUNG (7267864)	www.samsung.com/uk/support
IRELAND (EIRE)	0818 717100	www.samsung.com/ie/support
LITHUANIA	8-800-77777	www.samsung.com/lt/support
LATVIA	8000-7267	www.samsung.com/lv/support
ESTONIA	800-7267	www.samsung.com/ee/support
TURKEY	444 7711	www.samsung.com/tr/support