

SAMSUNG

USER MANUAL

SM-T720
SM-T725
SM-T727

English. 04/2019. Rev.1.0

www.samsung.com

Table of Contents

Basics

- 4 Read me first
- 6 Device overheating situations and solutions
- 10 Device layout and functions
- 15 Battery
- 18 SIM or USIM card (nano-SIM card) (SM-T725, SM-T727)
- 20 Memory card (microSD card)
- 25 Turning the device on and off
- 26 Initial setup
- 28 Samsung account
- 30 Transferring data from your previous device (Smart Switch)
- 33 Understanding the screen
- 45 Notification panel
- 47 Entering text

Apps and features

- 50 Installing or uninstalling apps
- 52 Phone (SM-T725)
- 57 Contacts

- 61 Messages
- 65 Internet
- 67 Email
- 68 Camera
- 81 Gallery
- 88 Multi window
- 91 Kids Home
- 93 Samsung Members
- 93 Samsung Notes
- 94 Calendar
- 95 Samsung Flow
- 97 My Files
- 97 Clock
- 99 Calculator
- 100 Game Launcher
- 103 Bixby Vision
- 106 Bixby Home
- 109 Reminder
- 113 SmartThings
- 117 Sharing content
- 118 Daily Board
- 120 Samsung DeX
- 129 Google apps

Settings

- 131 Introduction
- 131 Connections
 - 133 Wi-Fi
 - 135 Bluetooth
 - 137 Data saver (SM-T725, SM-T727)
 - 137 Mobile Hotspot and Tethering (SM-T725, SM-T727)
 - 139 More connection settings
- 140 Sounds and vibration / Sound
 - 141 Dolby Atmos (surround sound)
 - 141 Separate app sound
- 142 Notifications
 - 142 App icon badges
- 143 Display
 - 144 Blue light filter
 - 144 Changing the screen mode or adjusting the display colour
 - 146 Screensaver
- 146 Wallpaper
- 147 Lock screen
 - 148 Smart Lock
- 148 Biometrics and security
 - 150 Face recognition
 - 153 Fingerprint recognition
 - 156 Samsung Pass
 - 161 Secure Folder
- 166 Accounts and backup
 - 167 Users
 - 169 Samsung Cloud

- 170 Google
- 171 Advanced features
- 172 Digital wellbeing
- 174 Device care
- 177 Apps
- 177 General management
- 178 Accessibility
- 179 Software update
- 179 User manual
- 180 About tablet

Appendix

- 181 Troubleshooting
- 187 Removing the battery (SM-T720, SM-T725)

Basics

Read me first

Please read this manual before using the device to ensure safe and proper use.

- Descriptions are based on the device's default settings.
- Some content may differ from your device depending on the region, service provider, model specifications, or device's software.
- Content (high quality content) that requires high CPU and RAM usage will affect the overall performance of the device. Apps related to the content may not work properly depending on the device's specifications and the environment that it is used in.
- Samsung is not liable for performance issues caused by apps supplied by providers other than Samsung.
- Samsung is not liable for performance issues or incompatibilities caused by edited registry settings or modified operating system software. Attempting to customise the operating system may cause the device or apps to work improperly.
- Software, sound sources, wallpapers, images, and other media provided with this device are licensed for limited use. Extracting and using these materials for commercial or other purposes is an infringement of copyright laws. Users are entirely responsible for illegal use of media.
- You may incur additional charges for data services, such as messaging, uploading and downloading, auto-syncing, or using location services depending on your data plan. For large data transfers, it is recommended to use the Wi-Fi feature. (SM-T725, SM-T727)
- Default apps that come with the device are subject to updates and may no longer be supported without prior notice. If you have questions about an app provided with the device, contact a Samsung Service Centre. For user-installed apps, contact service providers.

- Modifying the device's operating system or installing softwares from unofficial sources may result in device malfunctions and data corruption or loss. These actions are violations of your Samsung licence agreement and will void your warranty.
- Depending on the region or service provider, a screen protector is attached for protection during production and distribution. Damage to the attached screen protector is not covered by the warranty.
- You can see the touchscreen clearly even in strong outdoor sunlight by automatically adjusting the contrast range based on the surrounding environment. Due to the nature of the product, displaying fixed graphics for extended periods may result in afterimages (screen burn-in) or ghosting.
 - It is recommended not to use fixed graphics on part or all of the touchscreen for extended periods and turn off the touchscreen when not using the device.
 - You can set the touchscreen to turn off automatically when you are not using it. Launch the **Settings** app, tap **Display** → **Screen timeout**, and then select the length of time you want the device to wait before turning off the touchscreen.
 - To set the touchscreen to automatically adjust its brightness based on the surrounding environment, launch the **Settings** app, tap **Display**, and then tap the **Adaptive brightness** switch to activate it.
- Depending on the region or model, some devices are required to receive approval from the Federal Communications Commission (FCC). If your device is approved by the FCC, you can view the FCC ID of the device. To view the FCC ID, launch the **Settings** app and tap **About tablet** → **Status**.
- Depending on the region, you can view the regulatory information on the device. To view the information, launch the **Settings** app and tap **About tablet** → **Regulatory information**.

Instructional icons



Warning: situations that could cause injury to yourself or others



Caution: situations that could cause damage to your device or other equipment



Notice: notes, usage tips, or additional information

Device overheating situations and solutions

When the device heats up while charging the battery

While charging, the device and the charger may become hot. During wireless charging or fast charging, the device may feel hotter to the touch. This does not affect the device's lifespan or performance and is in the device's normal range of operation. If the battery becomes too hot, the charger may stop charging.

Do the following when the device heats up:

- Disconnect the charger from the device and close any running apps. Wait for the device to cool down and then begin charging the device again.
- If the lower part of the device overheats, it could be because the connected USB cable is damaged. Replace the damaged USB cable with a new Samsung-approved one.
- When using a wireless charger, do not place foreign materials, such as metal objects, magnets, and magnetic stripe cards, between the device and the wireless charger.



The wireless charging or fast charging feature is only available on supported models.

When the device heats up during use

When you use features or apps that require more power or use them for extended periods, your device may temporarily heat up due to increased battery consumption. Close any running apps and do not use the device for a while.

The following are examples of situations in which the device may overheat. Depending on the functions and apps you use, these examples may not apply to your model.

- During the initial setup after purchase or when restoring data
- When downloading large files
- When using apps that require more power or using apps for extended periods
 - When playing high-quality games for extended periods
 - When recording videos for extended periods
 - When streaming videos while using the maximum brightness setting
 - When connecting to a TV
- While multitasking (or, when running many apps in the background)
 - When using Multi window
 - When updating or installing apps while recording videos
 - When downloading large files during a video call
 - When recording videos while using a navigation app
- When using large amount of data for syncing with the cloud, email, or other accounts
- When using a navigation app in a car while the device is placed in direct sunlight
- When using the mobile hotspot and tethering feature
- When using the device in areas with weak signals or no reception
- When charging the battery with a damaged USB cable
- When the device's multipurpose jack is damaged or exposed to foreign materials, such as liquid, dust, metal powder, and pencil lead
- When you are roaming

Do the following when the device heats up:

- Keep the device updated with the latest software.
- Conflicts between running apps may cause the device to heat up. Restart the device.
- Deactivate the Wi-Fi, GPS, and Bluetooth features when not using them.
- Close apps that increase battery consumption or that run in the background when not in use.
- Delete unnecessary files or unused apps.
- Decrease the screen brightness.
- If the device overheats or feels hot for a prolonged period, do not use it for a while. If the device continues to overheat, contact a Samsung Service Centre.

Device limitations when the device overheats

When the device heats up, the features and performance may be limited or the device may turn off to cool down. The feature is only available on supported models.

- If the device becomes hotter than usual, a device overheating message will appear. To lower the device's temperature, the screen brightness and the performance speed will be limited and battery charging will stop. Running apps will be closed and you will only be able to make emergency calls until the device cools down.
- If the device overheats or feels hot for a prolonged period, a power off message will appear. Turn off the device, and wait until it cools down.

Precautions for operating environment

Your device may heat up due to the environment in the following conditions. Use caution to avoid shortening the battery's lifespan, damaging the device, or causing a fire.

- Do not store your device in very cold or very hot temperatures.
- Do not expose your device to direct sunlight for extended periods.
- Do not use or store your device for extended periods in very hot areas, such as inside a car in the summertime.
- Do not place the device in any areas that may overheat, such as on an electric heating mat.
- Do not store your device near or in heaters, microwaves, hot cooking equipment, or high pressure containers.
- Never use a damaged charger or battery.

Device layout and functions

Package contents

Refer to the quick start guide for package contents.



- The items supplied with the device and any available accessories may vary depending on the region or service provider.
- The supplied items are designed only for this device and may not be compatible with other devices.
- Appearances and specifications are subject to change without prior notice.
- You can purchase additional accessories from your local Samsung retailer. Make sure they are compatible with the device before purchase.
- Use only Samsung-approved accessories. Using unapproved accessories may cause the performance problems and malfunctions that are not covered by the warranty.
- Availability of all accessories is subject to change depending entirely on manufacturing companies. For more information about available accessories, refer to the Samsung website.

Device layout

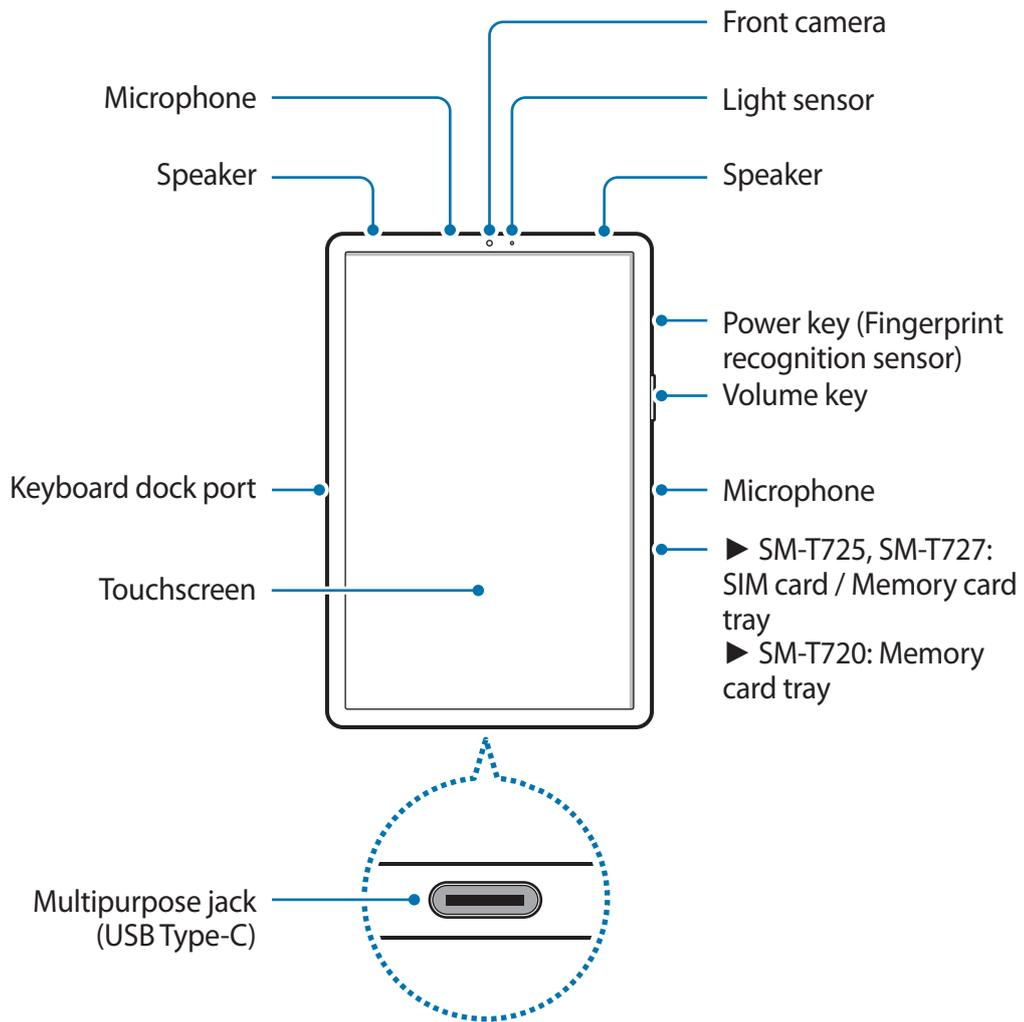

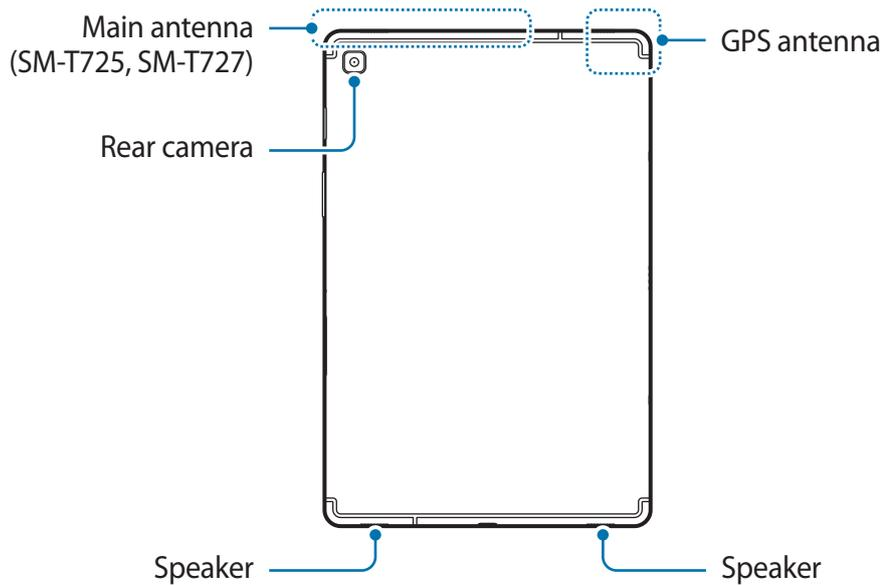

The device and some accessories (sold separately) contain magnets. The American Heart Association (US) and the Medicines and Healthcare Products Regulatory Agency (UK) both warn that magnets can affect the operation of implanted pacemakers, cardioverters, defibrillators, insulin pumps or other electro medical devices (collectively, "Medical Device") within the range of 15 cm (6 inches). If you are a user of any of these Medical Devices, **DO NOT USE THIS DEVICE AND SOME ACCESSORIES (SOLD SEPARATELY) UNLESS YOU HAVE CONSULTED WITH YOUR PHYSICIAN.**



- Do not store your device and some accessories (sold separately) near magnetic fields. Magnetic stripe cards, including credit cards, phone cards, passbooks, and boarding passes, may be damaged by magnetic fields.
- When using the speakers, such as when playing media files or using speakerphone, do not place the device close to your ears.
- Be careful not to expose the camera lens to a strong light source, such as direct sunlight. If the camera lens is exposed to a strong light source, such as direct sunlight, the camera image sensor may be damaged. A damaged image sensor is irreparable and will cause dots or spots in pictures.
- If you use the device with its glass or acrylic body broken, there may be a risk of injury. Use the device only after it has been repaired at a Samsung Service Centre.



- Connectivity problems and battery drain may occur in the following situations:
 - If you attach metallic stickers on the antenna area of the device
 - If you attach a device cover made with metallic material to the device
 - If you cover the device's antenna area with your hands or other objects while using certain features, such as calls or the mobile data connection (SM-T725, SM-T727)
- Using a Samsung-approved screen protector is recommended. Unapproved screen protectors may cause the sensors to malfunction.
- Do not cover the light sensor area with screen accessories, such as a screen protector or stickers. Doing so may cause the sensor to malfunction.
- Do not allow water to contact the touchscreen. The touchscreen may malfunction in humid conditions or when exposed to water.
- Connect an earphone to the Type-C earphone connector and plug the connector into the device's multipurpose jack. You can answer a call or listen to multimedia files when an earphone is connected. Call-related features may not be available depending on the connected earphone.

Hard keys

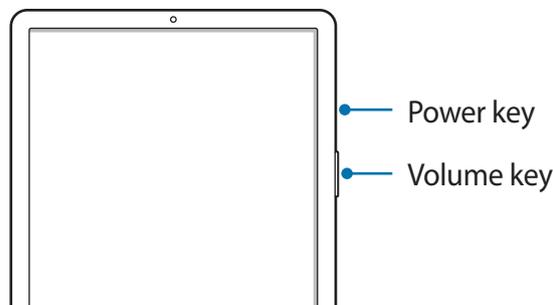

Key	Function
Power	<ul style="list-style-type: none"> • Press and hold to turn the device on or off. • Press to turn on or lock the screen.
Volume	<ul style="list-style-type: none"> • Press to adjust the device volume.

Soft buttons

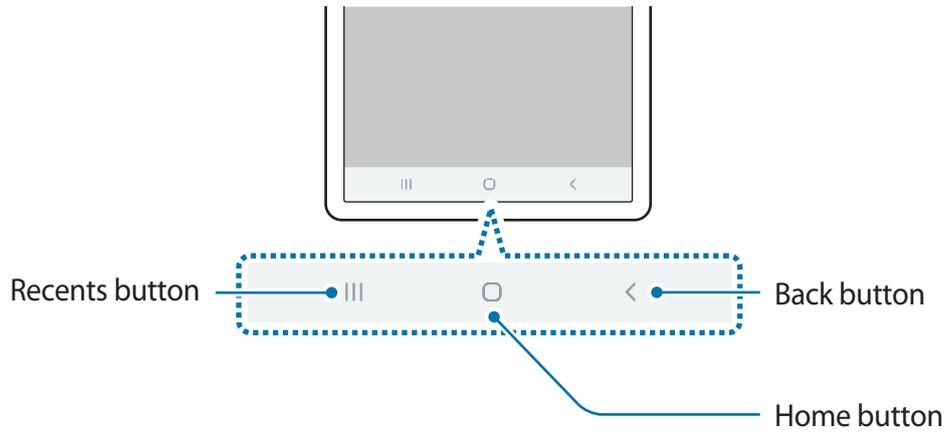

When you turn on the screen, the soft buttons will appear at the bottom of the screen. The soft buttons are set to the Recents button, Home button, and Back button by default. Refer to [Navigation bar \(soft buttons\)](#) for more information.

Battery

Charging the battery

Charge the battery before using it for the first time or when it has been unused for extended periods.



Use only Samsung-approved chargers, batteries, and cables. Unapproved chargers or cables can cause the battery to explode or damage the device.



- Connecting the charger improperly may cause serious damage to the device. Any damage caused by misuse is not covered by the warranty.
- Use only USB Type-C cable supplied with the device. The device may be damaged if you use Micro USB cable.



To save energy, unplug the charger when not in use. The charger does not have a power switch, so you must unplug the charger from the electric socket when not in use to avoid wasting power. The charger should remain close to the electric socket and easily accessible while charging.

- 1 Connect the USB cable to the USB power adaptor.
- 2 Plug the USB cable into the device's multipurpose jack.

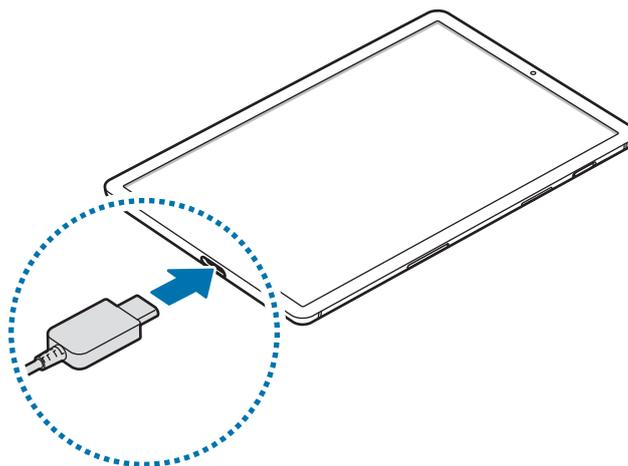

- 3 Plug the USB power adaptor into an electric socket.
- 4 After fully charging, disconnect the charger from the device. Then, unplug the charger from the electric socket.

Reducing the battery consumption

Your device provides various options that help you conserve battery power.

- Optimise the device using the device care feature.
- When you are not using the device, turn off the screen by pressing the Power key.
- Activate power saving mode.
- Close unnecessary apps.
- Deactivate the Bluetooth feature when not in use.
- Deactivate auto-syncing of apps that need to be synced.
- Decrease the backlight time.
- Decrease the screen brightness.

Battery charging tips and precautions

- When the battery power is low, the battery icon appears empty.
- If the battery is completely discharged, the device cannot be turned on immediately when the charger is connected. Allow a depleted battery to charge for a few minutes before turning on the device.
- If you use multiple apps at once, network apps, or apps that need a connection to another device, the battery will drain quickly. To avoid losing power during a data transfer, always use these apps after fully charging the battery.
- Using a power source other than the charger, such as a computer, may result in a slower charging speed due to a lower electric current.
- The device can be used while it is charging, but it may take longer to fully charge the battery.

- If the device receives an unstable power supply while charging, the touchscreen may not function. If this happens, unplug the charger from the device.
- While charging, the device and the charger may heat up. This is normal and should not affect the device's lifespan or performance. If the battery gets hotter than usual, the charger may stop charging.
- If you charge the device while the multipurpose jack is wet, the device may be damaged. Thoroughly dry the multipurpose jack before charging the device.
- If the device is not charging properly, take the device and the charger to a Samsung Service Centre.

Fast charging

The device has a built-in fast charging feature. You can charge the battery more quickly while the device or its screen is turned off.

Increasing the charging speed

To increase the charging speed, turn the device or its screen off when you charge the battery. While charging the battery when the device is turned off, the ⚡ icon appears on the screen.

If the fast charging feature is not activated, launch the **Settings** app, tap **Device care** → **Battery** → ⋮ → **Settings**, and then tap the **Fast cable charging** switch to activate it.



- You cannot use the built-in fast charging feature when you charge the battery using a standard battery charger.
- If the device heats up or the ambient air temperature rises, the charging speed may decrease automatically. This is a normal operating condition to prevent damage to the device.

SIM or USIM card (nano-SIM card) (SM-T725, SM-T727)

Installing the SIM or USIM card

Insert the SIM or USIM card provided by the mobile telephone service provider.



Use caution not to lose or let others use the SIM or USIM card. Samsung is not responsible for any damages or inconveniences caused by lost or stolen cards.



Some LTE services may not be available depending on the service provider. For more information about service availability, contact your service provider.

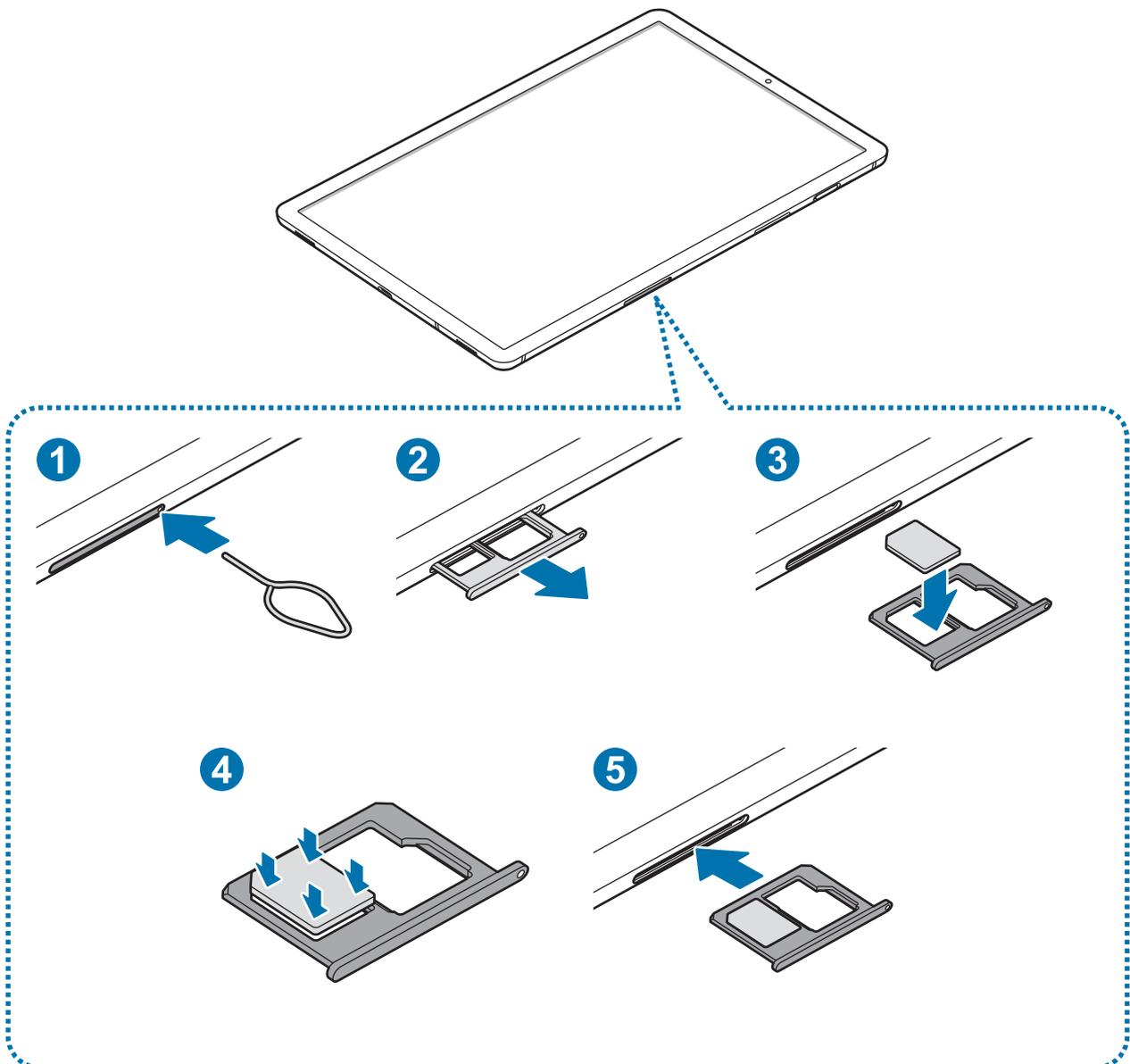

1 Insert the ejection pin into the hole on the tray to loosen the tray.

 Ensure that the ejection pin is perpendicular to the hole. Otherwise, the device may be damaged.

2 Pull out the tray gently from the tray slot.

3 Place the SIM or USIM card on the tray 1 with the gold-coloured contacts facing downwards.

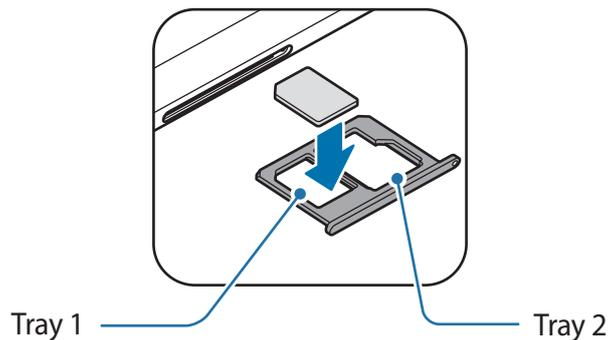

4 Gently press the SIM or USIM card into the tray to secure it.

 If the card is not fixed firmly into the tray, the SIM card may leave or fall out of the tray.

5 Insert the tray back into the tray slot.

-  • If you insert the tray into your device while the tray is wet, your device may be damaged. Always make sure the tray is dry.
- Fully insert the tray into the tray slot to prevent liquid from entering your device.

Correct card installation

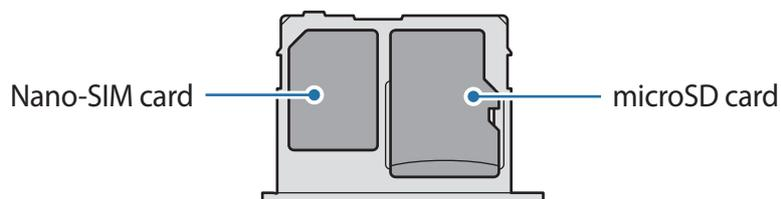

 Use only a nano-SIM card.

Removing the SIM or USIM card

- 1 Insert the ejection pin into the hole on the tray to loosen the tray.
- 2 Pull out the tray gently from the tray slot.
- 3 Remove the SIM or USIM card.
- 4 Insert the tray back into the tray slot.

Memory card (microSD card)

Installing a memory card

Your device's memory card capacity may vary from other models and some memory cards may not be compatible with your device depending on the memory card manufacturer and type. To view your device's maximum memory card capacity, refer to the Samsung website.



- Some memory cards may not be fully compatible with the device. Using an incompatible card may damage the device or the memory card, or corrupt the data stored in it.
- Use caution to insert the memory card right-side up.



- The device supports the FAT and the exFAT file systems for memory cards. When inserting a card formatted in a different file system, the device will ask to reformat the card or will not recognise the card. To use the memory card, you must format it. If your device cannot format or recognise the memory card, contact the memory card manufacturer or a Samsung Service Centre.
- Frequent writing and erasing of data shortens the lifespan of memory cards.
- When inserting a memory card into the device, the memory card's file directory appears in the **My Files** → **SD card** folder.

► SM-T725, SM-T727:

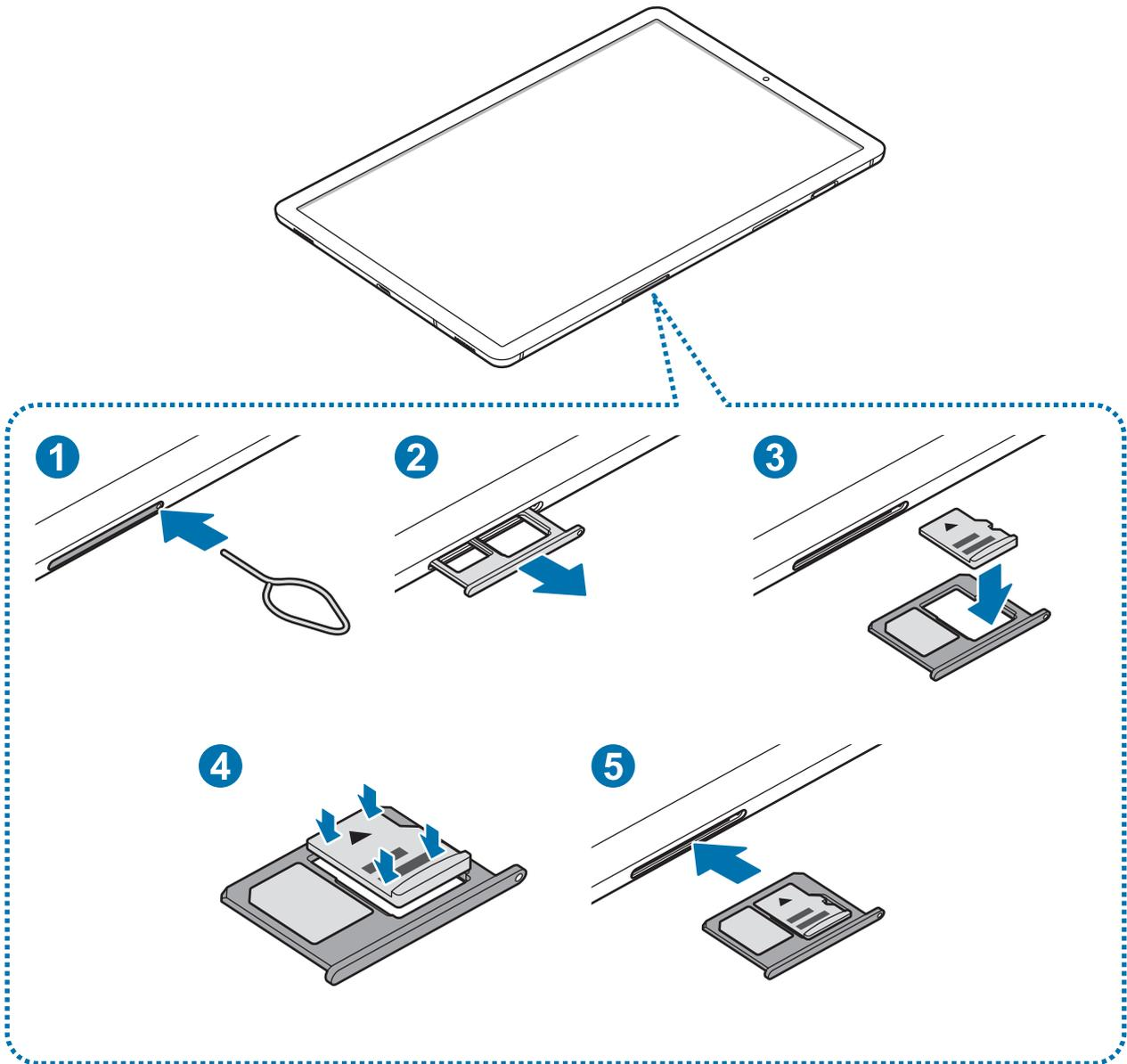

► SM-T720:

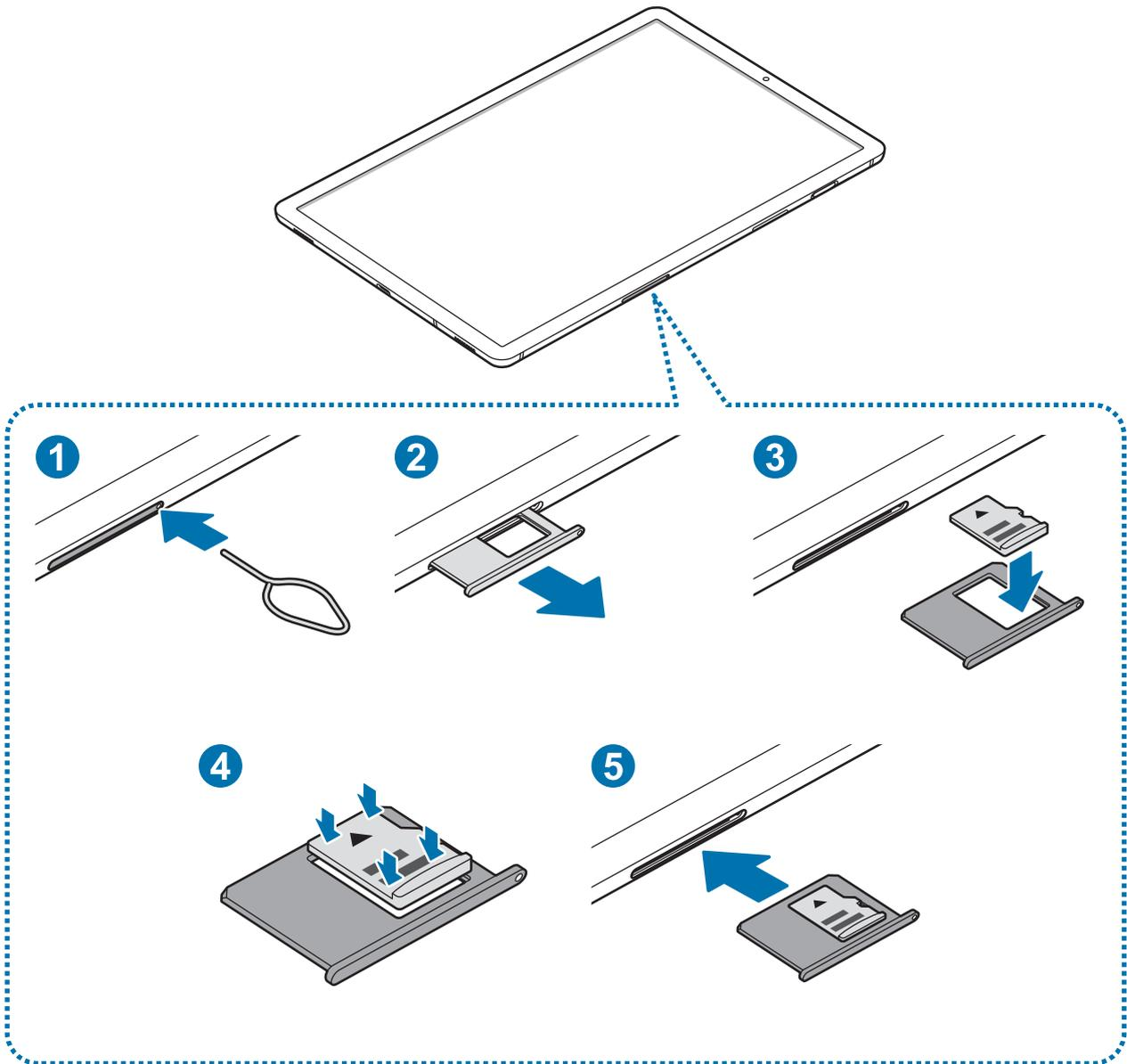

- ▶ **SM-T725, SM-T727:** Insert the ejection pin into the hole on the tray to loosen the tray.
▶ **SM-T720:** Insert the ejection pin into the hole on the memory card tray to loosen the tray.

 Ensure that the ejection pin is perpendicular to the hole. Otherwise, the device may be damaged.

- ▶ **SM-T725, SM-T727:** Pull out the tray gently from the tray slot.
▶ **SM-T720:** Pull out the memory card tray gently from the memory card tray slot.

 When you remove the tray from the device, the mobile data connection will be disabled. (SM-T725, SM-T727)

- ▶ **SM-T725, SM-T727:** Place a memory card on the tray 2 with the gold-coloured contacts facing downwards.

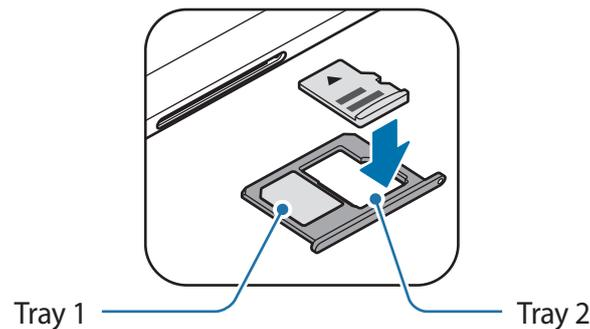

- ▶ **SM-T720:** Place a memory card on the memory card tray with the gold-coloured contacts facing downwards.

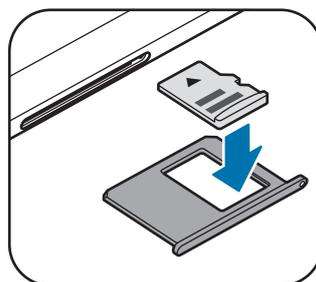

4 Gently press the memory card into the tray to secure it.



If the card is not fixed firmly into the tray, the memory card may leave or fall out of the tray.

5 ▶ **SM-T725, SM-T727:** Insert the tray back into the tray slot.

▶ **SM-T720:** Insert the memory card tray back into the memory card tray slot.



- If you insert the tray into your device while the tray is wet, your device may be damaged. Always make sure the tray is dry.

- Fully insert the tray into the tray slot to prevent liquid from entering your device.

Removing the memory card

Before removing the memory card, first unmount it for safe removal.

Launch the **Settings** app and tap **Device care** → **Storage** →  → **Storage settings** → **SD card** → **Unmount**.

1 ▶ **SM-T725, SM-T727:** Insert the ejection pin into the hole on the tray to loosen the tray.

▶ **SM-T720:** Insert the ejection pin into the hole on the memory card tray to loosen the tray.

2 ▶ **SM-T725, SM-T727:** Pull out the tray gently from the tray slot.

▶ **SM-T720:** Pull out the memory card tray gently from the memory card tray slot.

3 Remove the memory card.

4 ▶ **SM-T725, SM-T727:** Insert the tray back into the tray slot.

▶ **SM-T720:** Insert the memory card tray back into the memory card tray slot.



Do not remove external storage, such as a memory card or USB storage, while the device is transferring or accessing information, or right after transferring data. Doing so can cause data to be corrupted or lost or cause damage to the external storage or device. Samsung is not responsible for losses, including loss of data, resulting from the misuse of external storage devices.

Formatting the memory card

A memory card formatted on a computer may not be compatible with the device. Format the memory card on the device.

Launch the **Settings** app and tap **Device care** → **Storage** → **⋮** → **Storage settings** → **SD card** → **Format**.



Before formatting the memory card, remember to make backup copies of all important data stored in the memory card. The manufacturer's warranty does not cover loss of data resulting from user actions.

Turning the device on and off

Press and hold the Power key for a few seconds to turn on the device.

When you turn on your device for the first time or after performing a data reset, follow the on-screen instructions to set up your device.

To turn off the device, press and hold the Power key, and then tap **Power off**.



Follow all posted warnings and directions from authorised personnel in areas where the use of wireless devices is restricted, such as aeroplanes and hospitals.

Restarting the device

To restart the device, press and hold the Power key, and then tap **Restart**.

If your device is frozen and unresponsive, press and hold the Power key and the Volume Down key simultaneously for more than 7 seconds to restart it.

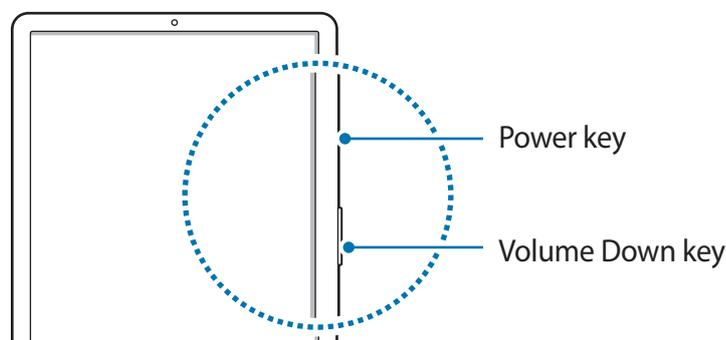

Initial setup

When you turn on your device for the first time or after performing a data reset, follow the on-screen instructions to set up your device.



The initial setup procedures may vary depending on the device's software and your region.

- 1 Turn on the device.
- 2 Select your preferred device language and select →.



- 3 Read and agree to the terms and conditions and tap **Next**.
- 4 Get your content from a previous device.

5 Select a Wi-Fi network and connect to it.



If you do not connect to a Wi-Fi network, you may not be able to set up some device features during the initial setup.

6 Follow the on-screen instructions to proceed the initial setup.

7 Set a screen lock method to protect your device. You can protect your personal information by preventing others from accessing your device. To set the screen lock method later, tap **Not now**.

8 If the recommended apps screen appears, select apps you want and download them.

9 Sign in to your Samsung account. You can enjoy Samsung services and keep your data up to date and secure across all of your devices. Refer to [Samsung account](#) for more information.

Samsung account

Introduction

Your Samsung account is an integrated account service that allows you to use a variety of Samsung services provided by mobile devices, TVs, and the Samsung website. Once your Samsung account has been registered, you can keep your data up to date and secure across your Samsung devices with Samsung Cloud, track and control your lost or stolen device, see tips and tricks from Samsung Members, and more.

Create your Samsung account with your email address.

To check the list of services that can be used with your Samsung account, visit account.samsung.com. For more information on Samsung accounts, launch the **Settings** app and tap **Accounts and backup** → **Accounts** → **Samsung account** →  → **Help**.

Registering your Samsung account

Registering a new Samsung account

If you do not have a Samsung account, you should create one.

- 1 Launch the **Settings** app and tap **Accounts and backup** → **Accounts** → **Add account** → **Samsung account**.
Alternatively, launch the **Settings** app and tap .
- 2 Tap **Create account**.
- 3 Follow the on-screen instructions to complete creating your account.

Registering an existing Samsung account

If you already have a Samsung account, register it to the device.

- 1 Launch the **Settings** app and tap **Accounts and backup** → **Accounts** → **Add account** → **Samsung account**.

Alternatively, launch the **Settings** app and tap .

- 2 Enter your Samsung account ID and password and tap **Sign in**.

If you forget your account information, tap **Find ID** or **Reset password**. You can find your account information when you enter the required information.

- 3 Read and agree to the terms and conditions and tap **Next** to finish registering your Samsung account.

If a pop-up window about using biometric data appears, tap **Register**. You can verify your Samsung account password via your biometric data, such as fingerprints. Refer to [Samsung Pass](#) for more information.

Removing your Samsung account

When you remove your registered Samsung account from the device, your data, such as contacts or events, will also be removed.

- 1 Launch the **Settings** app and tap **Accounts and backup** → **Accounts**.
- 2 Tap **Samsung account** →  → **Remove account**.
- 3 Tap **Remove**, enter your Samsung account password, and then tap **OK**.

Transferring data from your previous device (Smart Switch)

Connect with your previous device via Smart Switch to transfer data.

Launch the **Settings** app and tap **Accounts and backup** → **Smart Switch**.



- This feature may not be supported on some devices or computers.
- Limitations apply. Visit www.samsung.com/smartswitch for details. Samsung takes copyright seriously. Only transfer content that you own or have the right to transfer.

Transferring data wirelessly via Wi-Fi Direct

Transfer data from your previous device to your device wirelessly via Wi-Fi Direct.

- 1 On the previous device, launch Smart Switch.
If you do not have the app, download it from **Galaxy Store** or **Play Store**.
- 2 On your device, launch the **Settings** app and tap **Accounts and backup** → **Smart Switch**.
- 3 Place the devices near each other.
- 4 On the previous device, tap **Send data** → **Wireless**.
- 5 On the previous device, select an item to transfer and tap **Send**.
- 6 On your device, tap **Receive**.
- 7 Follow the on-screen instructions to transfer data from your previous device.

Transferring data using external storage

Transfer data using external storage, such as a microSD card.

- 1 Transfer data from your previous device to external storage.
- 2 Insert or connect the external storage device to your device.
- 3 On your device, launch the **Settings** app and tap **Accounts and backup** → **Smart Switch** →  → **Restore**.
- 4 Follow the on-screen instructions to transfer data from external storage.

Transferring backup data from a computer

Transfer data between your device and a computer. You must download the Smart Switch computer version app from www.samsung.com/smartswitch. Back up data from your previous device to a computer and import the data to your device.

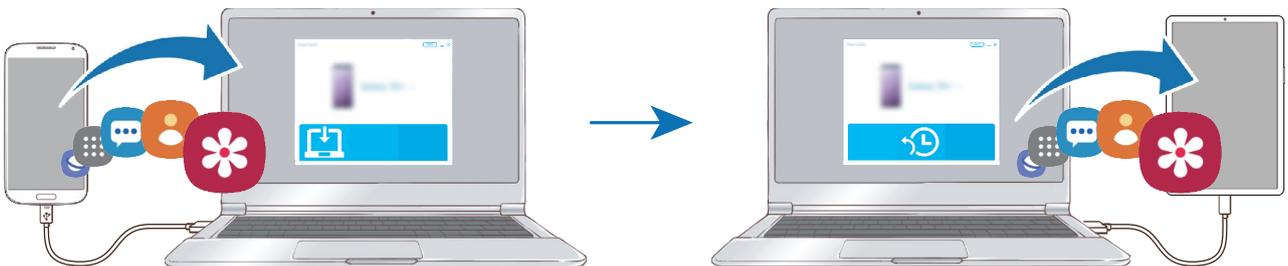

- 1 On the computer, visit www.samsung.com/smartswitch to download Smart Switch.
 - 2 On the computer, launch Smart Switch.
-  If your previous device is not a Samsung device, back up data to a computer using a program provided by the device's manufacturer. Then, skip to the fifth step.

- 3 Connect your previous device to the computer using the device's USB cable.
- 4 On the computer, follow the on-screen instructions to back up data from the device. Then, disconnect your previous device from the computer.
- 5 Connect your device to the computer using the USB cable.
- 6 On the computer, follow the on-screen instructions to transfer data to your device.

Viewing imported data

You can view the imported data on the same app from your previous device.

If your new device does not have the same apps to view or play the imported data, the data will be saved to a similar app.

Understanding the screen

Controlling the touchscreen



- Do not allow the touchscreen to come into contact with other electrical devices. Electrostatic discharges can cause the touchscreen to malfunction.
- To avoid damaging the touchscreen, do not tap it with anything sharp or apply excessive pressure to it with your fingertips.
- It is recommended not to use fixed graphics on part or all of the touchscreen for extended periods. Doing so may result in afterimages (screen burn-in) or ghosting.



- The device may not recognise touch inputs close to the edges of the screen, which are outside of the touch input area.
- It is recommended to use fingers when you use the touchscreen.

Tapping

Tap the screen.

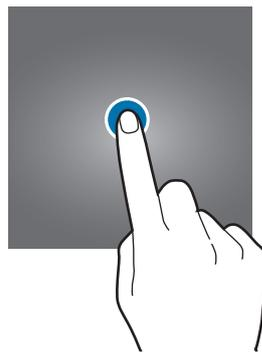

Tapping and holding

Tap and hold the screen for approximately 2 seconds.

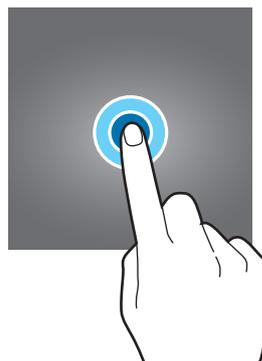

Dragging

Tap and hold an item and drag it to the target position.

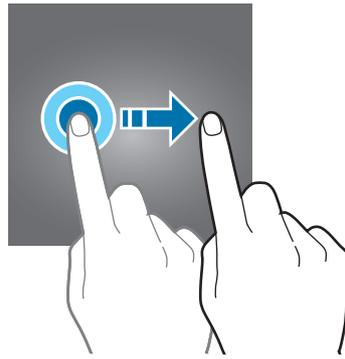

Double-tapping

Double-tap the screen.

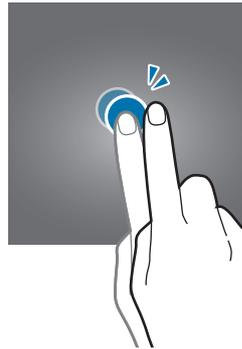

Swiping

Swipe upwards, downwards, to the left, or to the right.

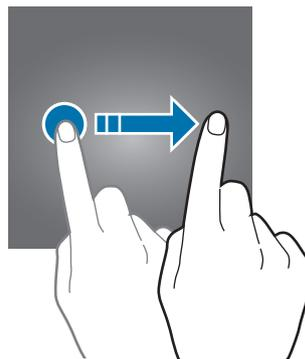

Spreading and pinching

Spread two fingers apart or pinch on the screen.

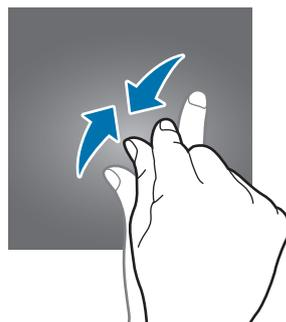
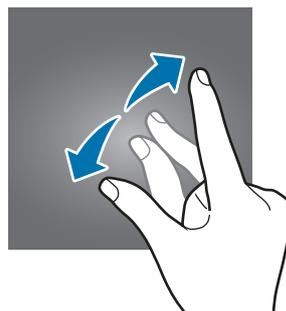

Navigation bar (soft buttons)

When you turn on the screen, the soft buttons will appear on the navigation bar at the bottom of the screen. The soft buttons are set to the Recents button, Home button, and Back button by default. The functions of the buttons can change according to the app currently being used or usage environment.

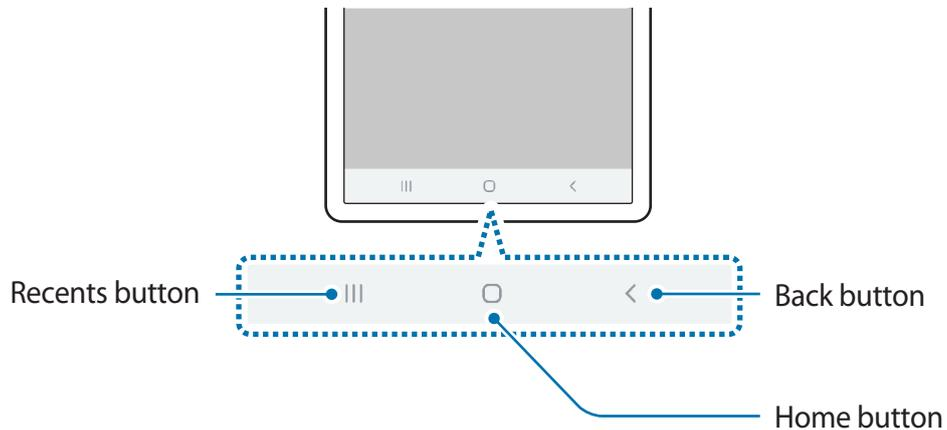

Button	Function
	<ul style="list-style-type: none"> • Tap to open the list of recent apps.
○	<ul style="list-style-type: none"> • Tap to return to the Home screen. • Tap and hold to launch the Google Assistant app.
<	<ul style="list-style-type: none"> • Tap to return to the previous screen.

Hiding the navigation bar

View files or use apps on a wider screen by hiding the navigation bar.

Launch the **Settings** app, tap **Display** → **Navigation bar**, and then tap **Full screen gestures** under **Navigation type**. The navigation bar will be hidden and the gesture hints will appear where the soft buttons are located. To use the soft buttons, drag the gesture hint of the desired button upwards.

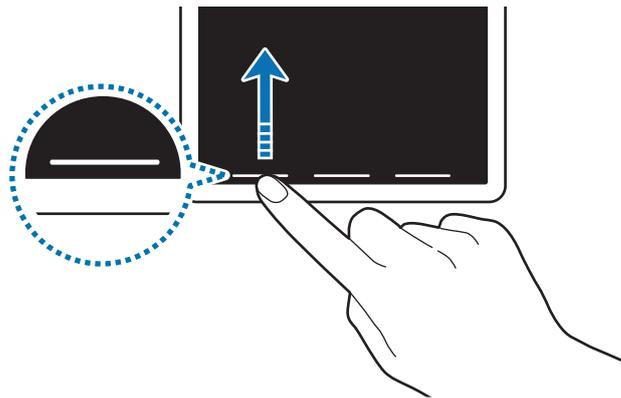

If you want to hide the gesture hints at the bottom of the screen, tap the **Gesture hints** switch to deactivate it.

Setting the navigation bar

Launch the **Settings** app, tap **Display** → **Navigation bar**, and then select an option.

- **Navigation type:** Set the device to hide or display the navigation bar. To hide the navigation bar, tap **Full screen gestures**. While the navigation bar is hidden, you can use the soft buttons by dragging the gesture hint of the desired button upwards.
- **Button order:** Change the order of the buttons on the navigation bar.
- **Gesture hints:** Set the device to display indicators at the bottom of the screen to show where the soft buttons are located. This feature appears only when you select **Full screen gestures**.

Home screen and Apps screen

The Home screen is the starting point for accessing all of the device's features. It displays widgets, shortcuts to apps, and more.

The Apps screen displays icons for all apps, including newly installed apps.



The screen may appear differently depending on the region or service provider.

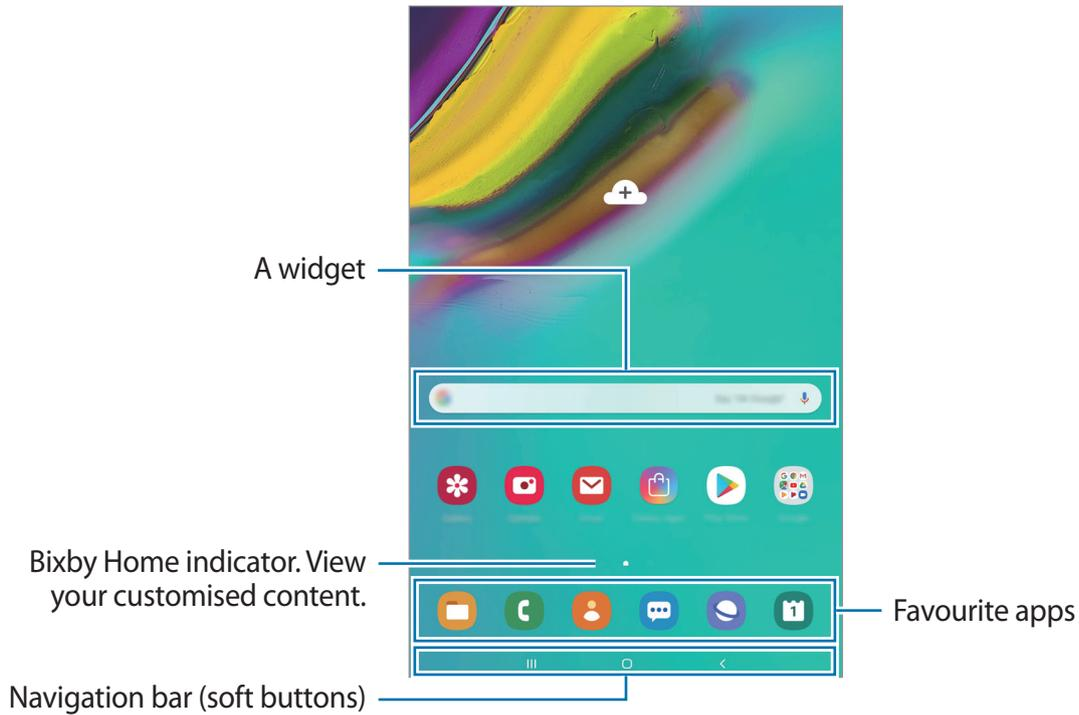

Switching between Home and Apps screens

On the Home screen, swipe upwards or downwards to open the Apps screen.

To return to the Home screen, swipe upwards or downwards on the Apps screen.

Alternatively, tap the Home button or the Back button.

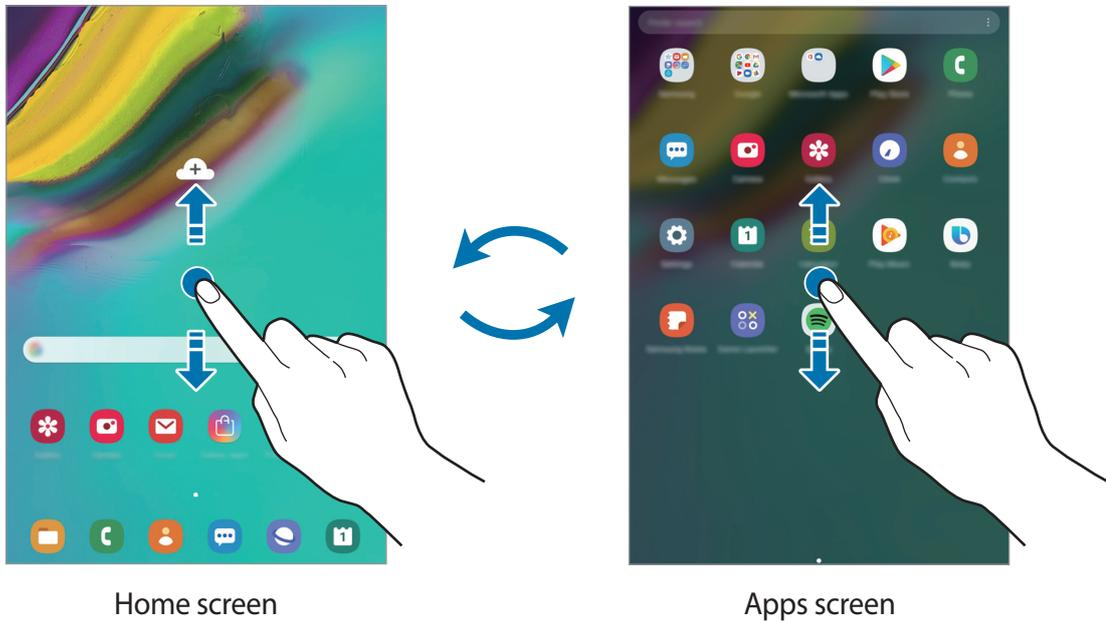

If you add the Apps button on the Home screen, you can open the Apps screen by tapping the button. On the Home screen, tap and hold an empty area, tap **Home screen settings**, and then tap the **Apps button** switch to activate it. The Apps button will be added at the bottom of the Home screen.



Moving items

Tap and hold an item, and then drag it to a new location. To move the item to another panel, drag it to the side of the screen.

To add a shortcut to an app on the Home screen, tap and hold an item on the Apps screen, and then drag it to the top of the screen. A shortcut to the app will be added on the Home screen.

You can also move frequently used apps to the shortcuts area at the bottom of the Home screen.

Creating folders

Create folders and gather similar apps to quickly access and launch apps.

On the Home screen or the Apps screen, tap and hold an app, and then drag it over another app.

A new folder containing the selected apps will be created. Tap **Enter folder name** and enter a folder name.

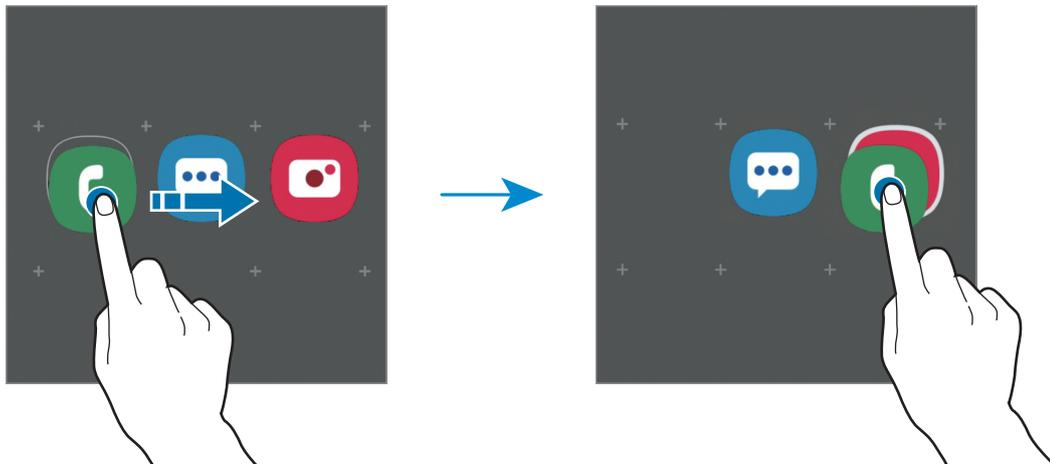

- **Adding more apps**

Tap **Add apps** on the folder. Tick the apps to add and tap **Add**. You can also add an app by dragging it to the folder.

- **Moving apps from a folder**

Tap and hold an app to drag it to a new location.

- **Deleting a folder**

Tap and hold a folder, and then tap **Delete folder**. Only the folder will be deleted. The folder's apps will be relocated to the Apps screen.

Editing the Home screen

On the Home screen, tap and hold an empty area, or pinch your fingers together to access the editing options. You can set the wallpaper, add widgets, and more. You can also add, delete, or rearrange Home screen panels.

- Adding panels: Swipe to the left, and then tap \oplus .
- Moving panels: Tap and hold a panel preview, and then drag it to a new location.
- Deleting panels: Tap 🗑 on the panel.

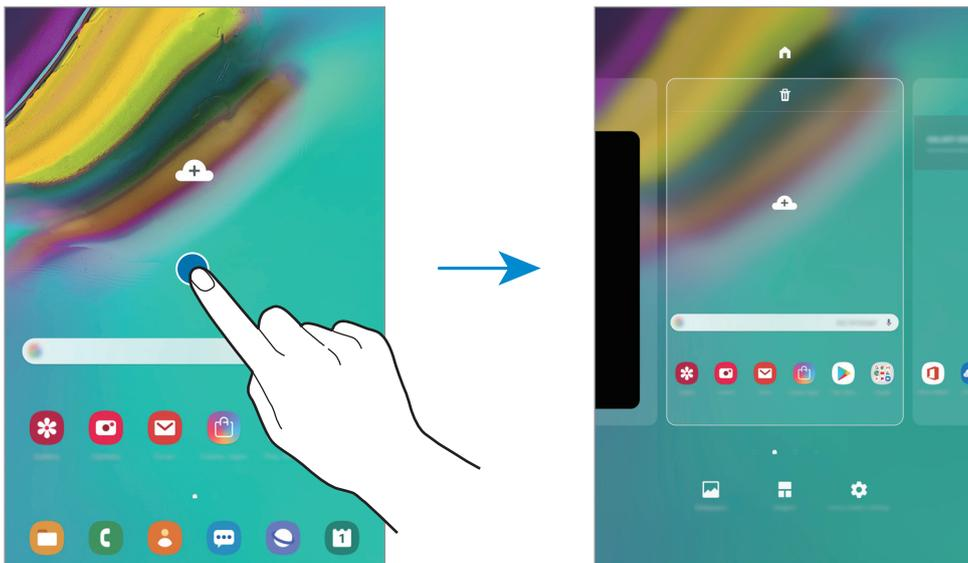

- **Wallpapers:** Change the wallpaper settings for the Home screen and the locked screen.
- **Widgets:** Widgets are small apps that launch specific app functions to provide information and convenient access on your Home screen. Tap and hold a widget, and then drag it to the Home screen. The widget will be added on the Home screen.
- **Home screen settings:** Change the Home screen settings.

Displaying all apps on the Home screen

Without using a separate Apps screen, you can set the device to display all apps on the Home screen. On the Home screen, tap and hold an empty area, and then tap **Home screen settings** → **Home screen layout** → **Home screen only** → **Apply**.

You can now access all your apps by swiping to the left on the Home screen.

Indicator icons

Indicator icons appear on the status bar at the top of the screen. The icons listed in the table below are most common.



- The status bar may not appear at the top of the screen in some apps. To display the status bar, drag down from the top of the screen.
- Some indicator icons appear only when you open the notification panel.
- Call-related features are not supported on some models.

Icon	Meaning
	No signal
	Signal strength
	Roaming (outside of normal service area)
	GPRS network connected
	EDGE network connected
	UMTS network connected
	HSDPA network connected
	HSPA+ network connected
	LTE network connected
	Wi-Fi connected
	Bluetooth feature activated
	Location services being used
	Call in progress
	Missed call
	New text or multimedia message
	Alarm activated
	Mute mode activated

Icon	Meaning
	Vibration mode activated
	Flight mode activated
	Error occurred or caution required
	Battery charging
	Battery power level

Lock screen

Pressing the Power key turns off the screen and locks it. Also, the screen turns off and automatically locks if the device is not used for a specified period.

To unlock the screen, swipe in any direction when the screen turns on.

If the screen is off, press the Power key or double-tap anywhere on the screen to turn on the screen.



Locked screen

Changing the screen lock method

To change the screen lock method, launch the **Settings** app, tap **Lock screen** → **Screen lock type**, and then select a method.

When you set a pattern, PIN, password, or your biometric data for the screen lock method, you can protect your personal information by preventing others from accessing your device. After setting the screen lock method, the device will require an unlock code whenever unlocking it.

- **Swipe:** Swipe in any direction on the screen to unlock it.
- **Pattern:** Draw a pattern with four or more dots to unlock the screen.
- **PIN:** Enter a PIN with at least four numbers to unlock the screen.
- **Password:** Enter a password with at least four characters, numbers, or symbols to unlock the screen.
- **None:** Do not set a screen lock method.
- **Face:** Register your face to unlock the screen. Refer to [Face recognition](#) for more information.
- **Fingerprints:** Register your fingerprints to unlock the screen. Refer to [Fingerprint recognition](#) for more information.



You can set your device to perform a factory data reset if you enter the unlock code incorrectly several times in a row and reach the attempt limit. Launch the **Settings** app, tap **Lock screen** → **Secure lock settings**, unlock the screen using the preset screen lock method, and then tap the **Auto factory reset** switch to activate it.

Screen capture

Capture a screenshot while using the device and write on, draw on, crop, or share the captured screen. You can capture the current screen and scrollable area.

Use the following methods to capture a screenshot. Captured screenshots will be saved in **Gallery**.

- Key capture: Press and hold the Volume Down key and the Power key simultaneously.
- Swipe capture: Swipe your hand to the left or right across the screen.



- It is not possible to capture a screenshot while using some apps and features.
- If capturing a screenshot by swiping is not activated, launch the **Settings** app, tap **Advanced features** → **Motions and gestures**, and then tap the **Palm swipe to capture** switch to activate it.

After capturing a screenshot, use the following options on the toolbar at the bottom of the screen:



- : Capture the current content and the hidden content on an elongated page, such as a webpage. When you tap , the screen will automatically scroll down and more content will be captured.
- : Crop a portion from the screenshot. The cropped area will be saved in **Gallery**.
- : Write or draw on the screenshot.
- : Share the screenshot with others.



- If the options are not visible on the captured screen, launch the **Settings** app, tap **Advanced features**, and then tap the **Smart capture** switch to activate it.

Notification panel

When you receive new notifications, indicator icons appear on the status bar. To see more information about the icons, open the notification panel and view the details.

To open the notification panel, drag the status bar downwards. To close the notification panel, swipe upwards on the screen.

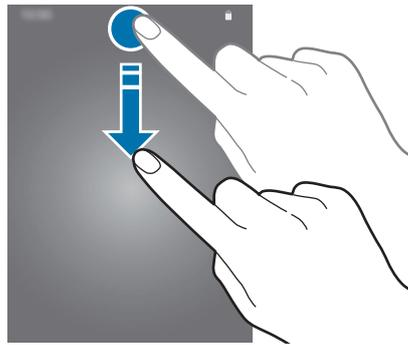

You can use the following functions on the notification panel.

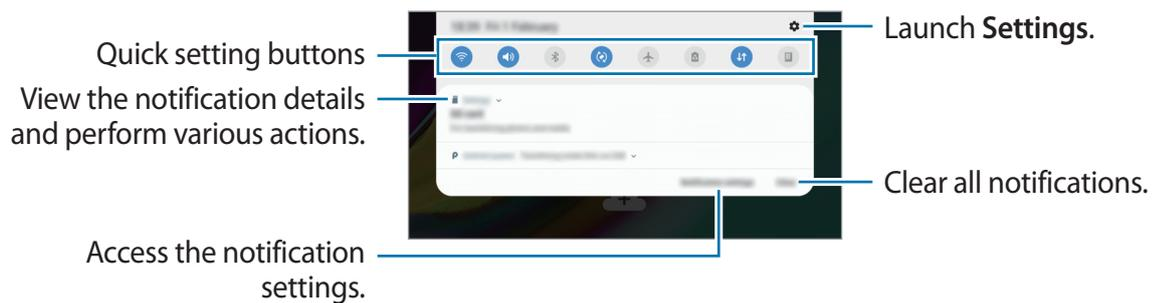

Using quick setting buttons

Tap quick setting buttons to activate certain features. Swipe downwards on the notification panel to view more buttons.

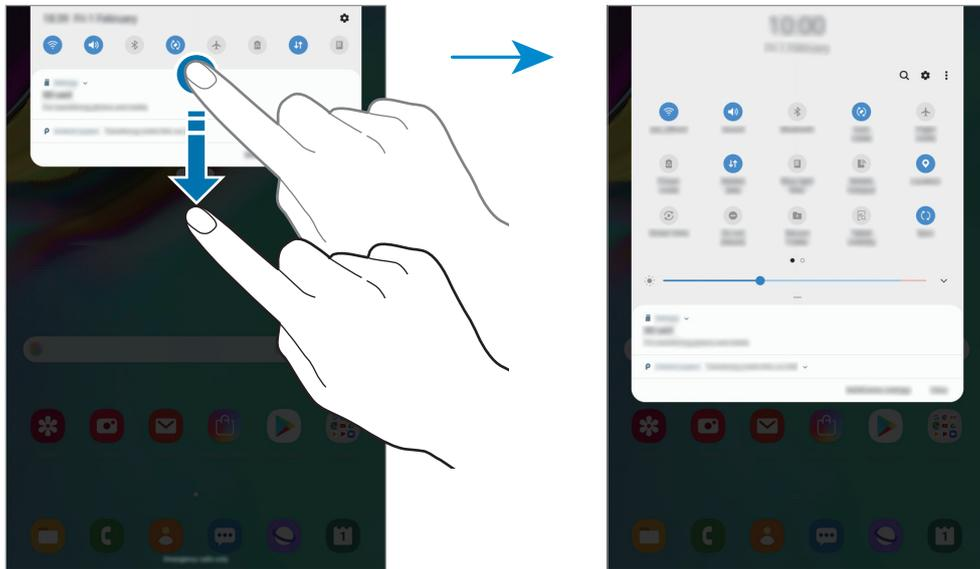

To change feature settings, tap the text under each button. To view more detailed settings, tap and hold a button.

To rearrange buttons, tap  → **Button order**, tap and hold a button, and then drag it to another location.

Entering text

Keyboard layout

A keyboard appears automatically when you enter text to send emails, create notes, and more.



Text entry is not supported in some languages. To enter text, you must change the input language to one of the supported languages.

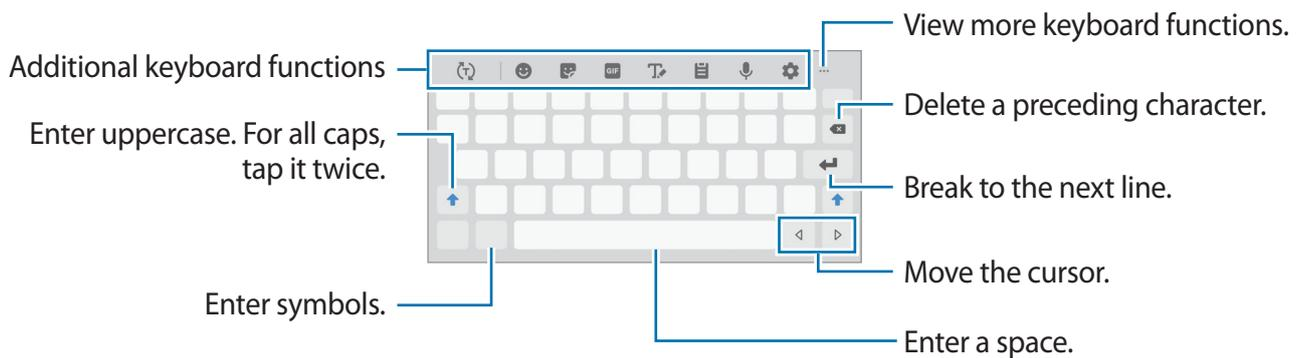

Changing the input language

Tap the input language key to switch between the input languages. Tap **⚙️** → **Languages and types** → **Manage input languages**, and then select the languages to use.

Changing the keyboard

Tap  to change the keyboard.

To change the keyboard type, tap  → **Languages and types**, select a language, and then select the keyboard type you want.



If the keyboard button () does not appear on the navigation bar, launch the **Settings** app, tap **General management** → **Language and input**, and then tap the **Show Keyboard button** switch to activate it.

Additional keyboard functions



Some features may not be available depending on the region or service provider.

- : Predict words based on your input and show word suggestions. To return to the keyboard functions list, tap .
- : Enter emoticons.
- : Enter stickers.
- : Attach animated GIFs.
- : Switch to handwriting mode.

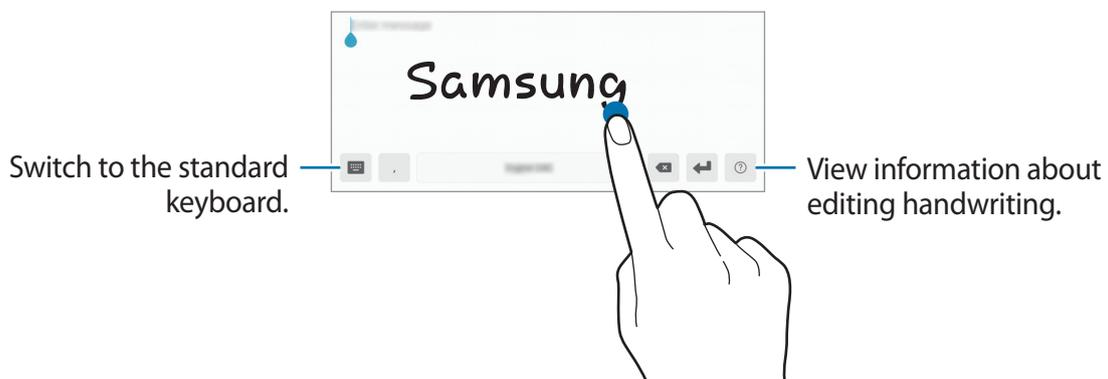

-  → **Qwerty keyboard**: Switch to the qwerty keyboard.
-  → **Handwriting**: Switch to handwriting mode.
- : Add an item from the clipboard.
- : Enter text by voice.
- : Change the keyboard settings.
-  → : Change the keyboard mode or size.
-  → : Open the text editing panel.

Copying and pasting

- 1 Tap and hold over text.
- 2 Drag  or  to select the desired text, or tap **Select all** to select all text.
- 3 Tap **Copy** or **Cut**.
The selected text is copied to the clipboard.
- 4 Tap and hold where the text is to be inserted and tap **Paste**.
To paste text that you have previously copied, tap **Clipboard** and select the text.

Dictionary

Look up definitions for words while using certain features, such as when browsing webpages.

- 1 Tap and hold over a word that you want to look up.
If the word you want to look up is not selected, drag  or  to select the desired text.
- 2 Tap **Dictionary** on the options list.
If a dictionary is not preinstalled on the device, tap **Move to Manage dictionaries**, tap  next to a dictionary, and then tap **INSTALL** to download it.
- 3 View the definition in the dictionary pop-up window.
To switch to the full screen view, tap . Tap the definition on the screen to view more definitions. In the detailed view, tap  to add the word to your favourite words list or tap **Search Web** to use the word as a search term.

Apps and features

Installing or uninstalling apps

Galaxy Store

Purchase and download apps. You can download apps that are specialised for Samsung Galaxy devices.

Launch the **Galaxy Store** app.



This app may not be available depending on the region or service provider.

Installing apps

Browse apps by category or tap the search field to search for a keyword.

Select an app to view information about it. To download free apps, tap **INSTALL**. To purchase and download apps where charges apply, tap the price and follow the on-screen instructions.



To change the auto update settings, tap  → **Settings** → **Auto update apps**, and then select an option.

Play Store

Purchase and download apps.

Launch the **Play Store** app.

Installing apps

Browse apps by category or search for apps by keyword.

Select an app to view information about it. To download free apps, tap **INSTALL**. To purchase and download apps where charges apply, tap the price and follow the on-screen instructions.



To change the auto update settings, tap  → **Settings** → **Auto-update apps**, and then select an option.

Managing apps

Uninstalling or disabling apps

Tap and hold an app and select an option.

- **Disable:** Disable selected default apps that cannot be uninstalled from the device.
- **Uninstall:** Uninstall downloaded apps.

Enabling apps

Launch the **Settings** app, tap **Apps** → ▼ → **Disabled**, select an app, and then tap **Enable**.

Setting app permissions

For some apps to operate properly, they may need permission to access or use information on your device. When you open an app, a pop-up window may appear and request access to certain features or information. Tap **Allow** on the pop-up window to grant permissions to the app.

To view your app permission settings, launch the **Settings** app and tap **Apps**. Select an app and tap **Permissions**. You can view the app's permissions list and change its permissions.

To view or change app permission settings by permission category, launch the **Settings** app and tap **Apps** → ⋮ → **App permissions**. Select an item and tap the switches next to apps to grant permissions.



If you do not grant permissions to apps, the basic features of the apps may not function properly.

Phone (SM-T725)

Introduction

Make or answer voice and video calls.



To make a call and send a text message, launch the **Settings** app, tap **Connections**, and then tap the **Call & Message Continuity** switch to activate it. You must register and sign in to the same Samsung account on your device and the other device. (SM-T720)

Making calls

- 1 Launch the **Phone** app and tap **Keypad**.
- 2 Enter a phone number.
- 3 Tap  to make a voice call, or tap  to make a video call.

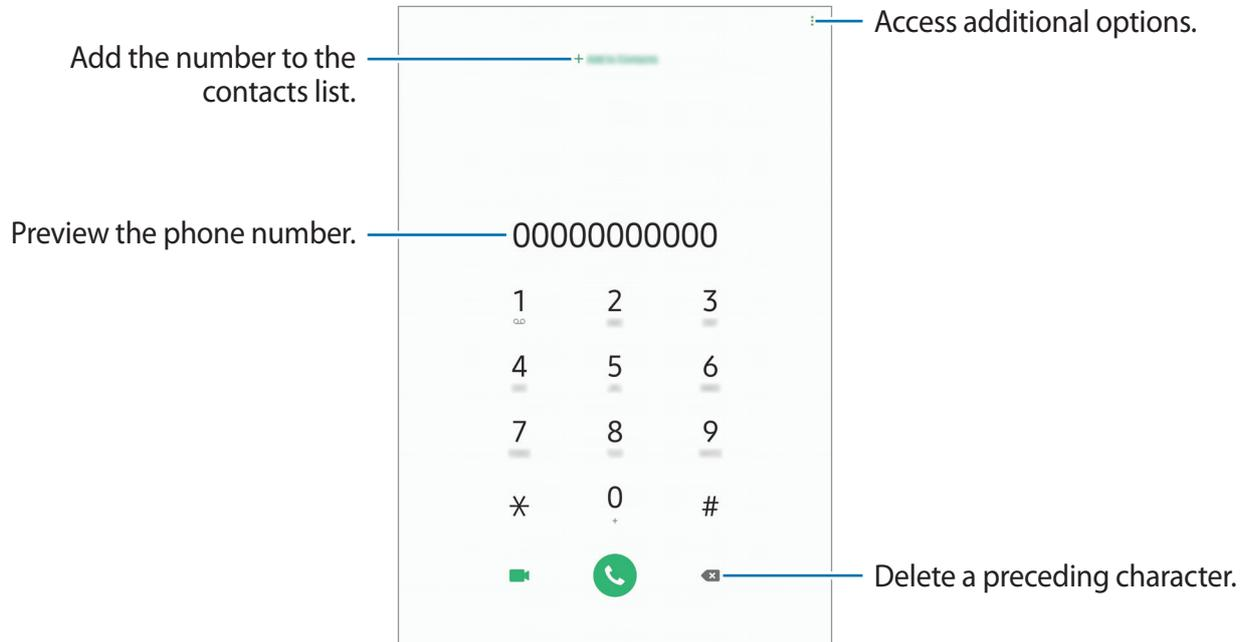

Making calls from call logs or contacts list

Tap **Recents** or **Contacts**, and then swipe to the right on a contact or a phone number to make a call.

If this feature is deactivated, launch the **Settings** app, tap **Advanced features** → **Motions and gestures**, and then tap the **Swipe to call or send messages** switch to activate it.

Using speed dial

Set speed dial numbers to quickly make calls.

To set a number to speed dial, tap **Keypad** or **Contacts** →  → **Speed dial numbers**, select a speed dial number, and then add a phone number.

To make a call, tap and hold a speed dial number on the keypad. For speed dial numbers 10 and up, tap the first digit(s) of the number, and then tap and hold the last digit.

For example, if you set the number **123** as a speed dial number, tap **1**, tap **2**, and then tap and hold **3**.

Making calls from the locked screen

On the locked screen, drag  outside the circle.

Making an international call

- 1 Launch the **Phone** app and tap **Keypad**.
- 2 Tap and hold **0** until the + sign appears.
- 3 Enter the country code, area code, and phone number, and then tap .

Receiving calls

Answering a call

When a call comes in, drag  outside the large circle.

Rejecting a call

When a call comes in, drag  outside the large circle.

To send a message when rejecting an incoming call, drag the **Send message** bar upwards. If the **Add reminder** switch is activated, a reminder will be saved to alert you of the rejected call one hour later.

To create various rejection messages, launch the **Phone** app, tap  → **Settings** → **Quick decline messages**, enter a message, and then tap .

Missed calls

If a call is missed, the  icon appears on the status bar. Open the notification panel to view the list of missed calls. Alternatively, launch the **Phone** app and tap **Recents** to view missed calls.

Blocking phone numbers

Block calls from specific numbers added to your block list.

1 Launch the **Phone** app and tap  → **Settings** → **Block numbers**.

2 Tap **Recents** or **Contacts**, select contacts, and then tap **Done**.

To manually enter a number, tap **Add phone number**, enter a phone number, and then tap .

When blocked numbers try to contact you, you will not receive notifications. The calls will be logged in the call log.



You can also block incoming calls from people that do not show their caller ID. Tap the **Block unknown callers** switch to activate the feature.

Options during calls



If the area around the rear camera is covered, unwanted noises may incur during a call. Remove accessories, such as a screen protector or stickers, around the rear camera area.

During a voice call

The following actions are available:

- : Access additional options.
- **Add call:** Dial a second call. The first call will be put on hold. When you end the second call, the first call will be resumed.
- **Message:** Send a message.
- **Bluetooth:** Switch to a Bluetooth headset if it is connected to the device.
- **Hold call:** Hold a call. Tap **Resume call** to retrieve the held call.
- **Mute:** Turn off the microphone so that the other party cannot hear you.
- **Keypad / Hide:** Open or close the keypad.
- : End the current call.

During a video call

Tap the screen to use the following options:

- : Access additional options.
- **Camera:** Turn off the camera so that the other party cannot see you.
- **Switch:** Switch between the front and rear cameras.
- : End the current call.
- **Mute:** Turn off the microphone so that the other party cannot hear you.
- **Bluetooth:** Switch to a Bluetooth headset if it is connected to the device.

Adding a phone number to Contact

Adding a phone number to Contacts from the keypad

- 1 Launch the **Phone** app and tap **Keypad**.
- 2 Enter the number.
- 3 Tap **Add to Contacts**.
- 4 Tap **Create contact** to create a new contact, or tap **Update existing** to add the number to an existing contact.

Adding a phone number to Contacts from the calls list

- 1 Launch the **Phone** app and tap **Recents**.
- 2 Tap a phone number and tap **Add**.
- 3 Tap **Create contact** to create a new contact, or tap **Update existing** to add the number to an existing contact.

Adding a tag to a phone number

You can add tags to numbers without saving them to Contact. This allows you to view the caller's information when they call without having them listed in Contact.

- 1 Launch the **Phone** app and tap **Recents**.
- 2 Tap a phone number.
- 3 Tap **Add tag**, enter a tag, and then tap **Add**.

When a call comes from that number, the tag will show under the number.

Contacts

Introduction

Create new contacts or manage contacts on the device.

Adding contacts

Creating a new contact

- 1 Launch the **Contacts** app and tap .
- 2 Select a storage location and tap **Select**.
- 3 Enter contact information.

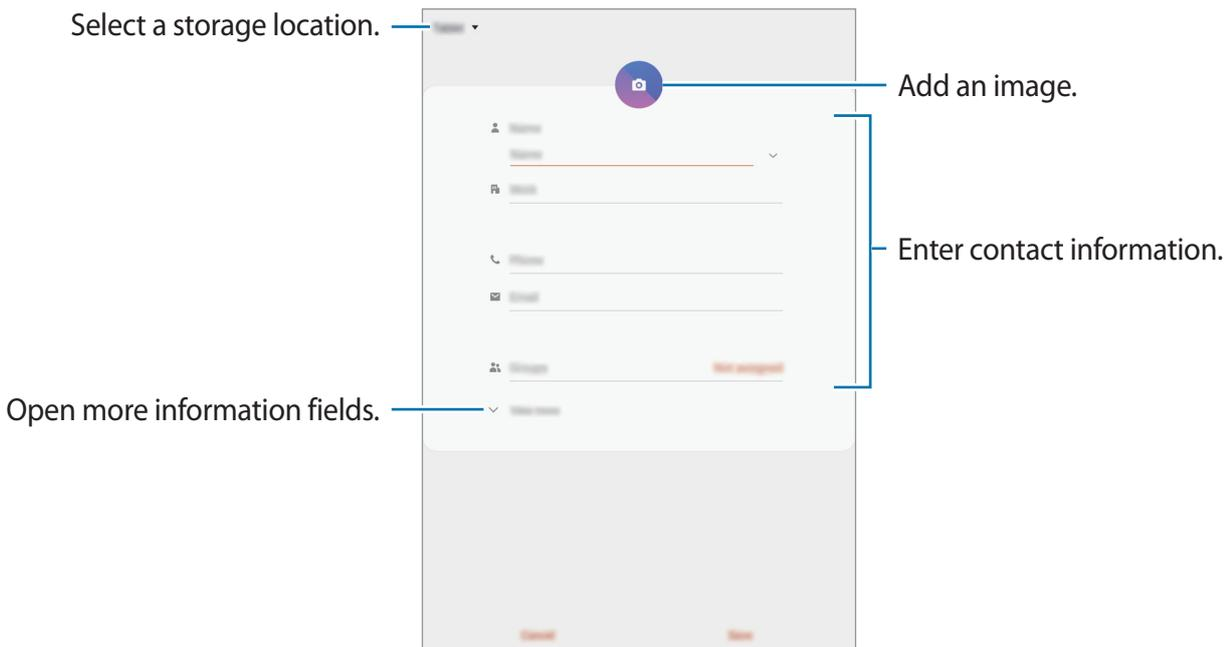

Depending on the selected storage location, the types of information you can save may vary.

- 4 Tap **Save**.

Importing contacts

Add contacts by importing them from other storages to your device.

- 1 Launch the **Contacts** app and tap  → **Manage contacts** → **Import/export contacts** → **Import**.
- 2 Select a storage location to import contacts from.
- 3 Tick VCF files or contacts to import and tap **Done**.
- 4 Select a storage location to save contacts to and tap **Import**.

Syncing contacts with your web accounts

Sync your device contacts with online contacts saved in your web accounts, such as your Samsung account.

- 1 Launch the **Settings** app, tap **Accounts and backup** → **Accounts** and select the account to sync with.
- 2 Tap **Sync account** and tap the **Contacts** switch to activate it.
For the Samsung account, tap  → **Sync settings** and tap the **Contacts** switch to activate it.

Searching for contacts

Launch the **Contacts** app.

Use one of the following search methods:

- Scroll up or down the contacts list.
- Drag a finger along the index at the right side of the contacts list to scroll through it quickly.
- Tap **Q** at the top of the contacts list and enter search criteria.

Tap the contact. Then take one of the following actions:



To make a call and send a text message, launch the **Settings** app, tap **Connections**, and then tap the **Call & Message Continuity** switch to activate it. You must register and sign in to the same Samsung account on your device and the other device. (SM-T720)

- ☆ : Add to favourite contacts.
- 📞 / 📺 : Make a voice or video call.



This feature may not be available depending on the model.

- 💬 : Compose a message.
- ✉️ : Compose an email.

Sharing contacts

You can share contacts with others by using various sharing options.

- 1 Launch the **Contacts** app and tap **⋮** → **Share**.
- 2 Select contacts and tap **Share**.
- 3 Select a sharing method.

Saving and sharing profile (SM-T725, SM-T727)

Save and share your profile information, such as your photo and status message, with others using the profile sharing feature.



- The profile sharing feature may not be available depending on the region or service provider.
- The profile sharing feature is only available for contacts who have activated the profile sharing feature on their device.

1 Launch the **Contacts** app and select your profile.

2 Tap **Edit**, edit your profile, and tap **Save**.

3 Tap **Tap here to share your profile** and tap the switch to activate it.

To use the profile sharing feature, your phone number must be verified. You can view your contacts' updated profile information in **Contacts**.

To change the scope of contacts to share your profile with, tap **Select what's shared**, select an item to share, and then select an option.

Creating groups

You can add groups, such as family or friends, and manage contacts by group.

1 Launch the **Contacts** app and tap  → **Groups** → **Create group**.

2 Enter a group name.

To set a group ringtone, tap **Group ringtone** and select a ringtone. (SM-T725)



To set a group ringtone, launch the **Settings** app, tap **Connections**, and then tap the **Call & Message Continuity** switch to activate it. You must register and sign in to the same Samsung account on your device and the other device. (SM-T720)

3 Tap **Add member**, select contacts to add to the group, and then tap **Done**.

4 Tap **Save**.

Sending a group message

You can send a group message to a group's members at the same time.

Launch the **Contacts** app, tap  → **Groups**, select a group, and then tap  → **Send message**.



To make a call and send a text message, launch the **Settings** app, tap **Connections**, and then tap the **Call & Message Continuity** switch to activate it. You must register and sign in to the same Samsung account on your device and the other device.
(SM-T720)

Merging duplicate contacts

When you import contacts from other storages, or sync contacts with other accounts, your contacts list may include duplicate contacts. Merge duplicate contacts into one to streamline your contacts list.

- 1 Launch the **Contacts** app and tap  → **Manage contacts** → **Merge contacts**.
- 2 Tick contacts and tap **Merge**.

Deleting contacts

- 1 Launch the **Contacts** app and tap  → **Delete**.
- 2 Select contacts and tap **Delete**.

To delete contacts one by one, open the contacts list and tap a contact. Then tap  → **Delete**.

Messages

Introduction

Send and view messages by conversation.



To make a call and send a text message, launch the **Settings** app, tap **Connections**, and then tap the **Call & Message Continuity** switch to activate it. You must register and sign in to the same Samsung account on your device and the other device.
(SM-T720)

Sending messages



You may incur additional charges for sending messages when you are roaming.

1 Launch the **Messages** app and tap .

2 Add recipients and enter a message.

To record and send a voice message, tap and hold , say your message, and then release your finger. The recording icon appears only while the keyboard is hidden.

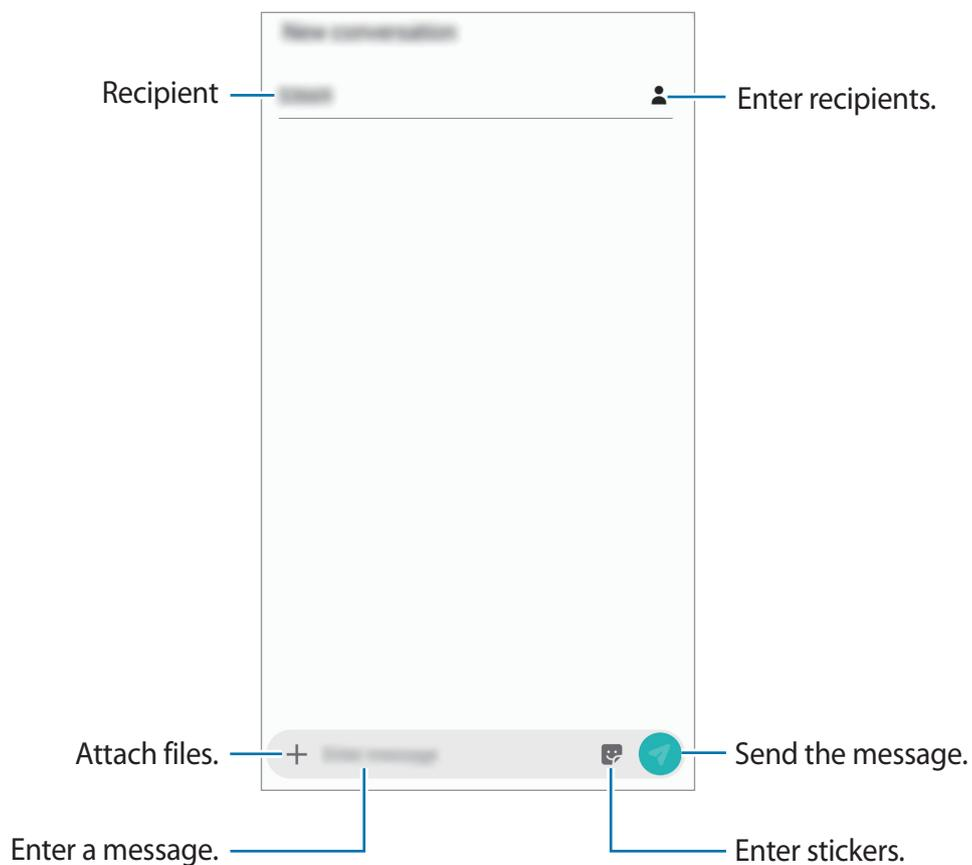

3 Tap  to send the message.

Viewing messages

Messages are grouped into message threads by contact.



You may incur additional charges for receiving messages when you are roaming.

1 Launch the **Messages** app and tap **Conversations**.

2 On the messages list, select a contact.

3 View your conversation.

To reply to the message, tap **Enter message**, enter a message, and then tap .

To adjust the font size, spread two fingers apart or pinch on the screen.

Blocking unwanted messages

Block messages from specific numbers added to your block list.

1 Launch the **Messages** app and tap  → **Settings** → **Block numbers and messages** → **Block numbers**.

2 Tap **Inbox** and select a contact. Or, tap **Contacts**, select contacts, and then tap **Done**.

To manually enter a number, enter a phone number under **Enter number** and tap .

Setting the message notification

You can change notification sound, display options, and more.

- 1 Launch the **Messages** app, tap **⋮** → **Settings** → **Notifications**, and then tap the switch to activate it.
- 2 Change the notification settings.

Setting a message reminder

You can set an alert at an interval to let you know that you have unchecked notifications. If this feature is not activated, launch the **Settings** app, tap **Accessibility** → **Advanced settings** → **Notification reminders**, and then tap the switch to activate it.

Deleting messages

- 1 Launch the **Messages** app and tap **Conversations**.
- 2 On the messages list, select a contact.
- 3 Tap and hold a message, tap **Delete**.
To delete multiple messages, tick messages you want to delete.
- 4 Tap **Delete**.

Internet

Introduction

Browse the Internet to search for information and bookmark your favourite webpages to access them conveniently.

Browsing webpages

- 1 Launch the **Internet** app.
- 2 Tap the address field.
- 3 Enter the web address or a keyword, and then tap **Go**.

To view the toolbars, drag your finger downwards slightly on the screen.

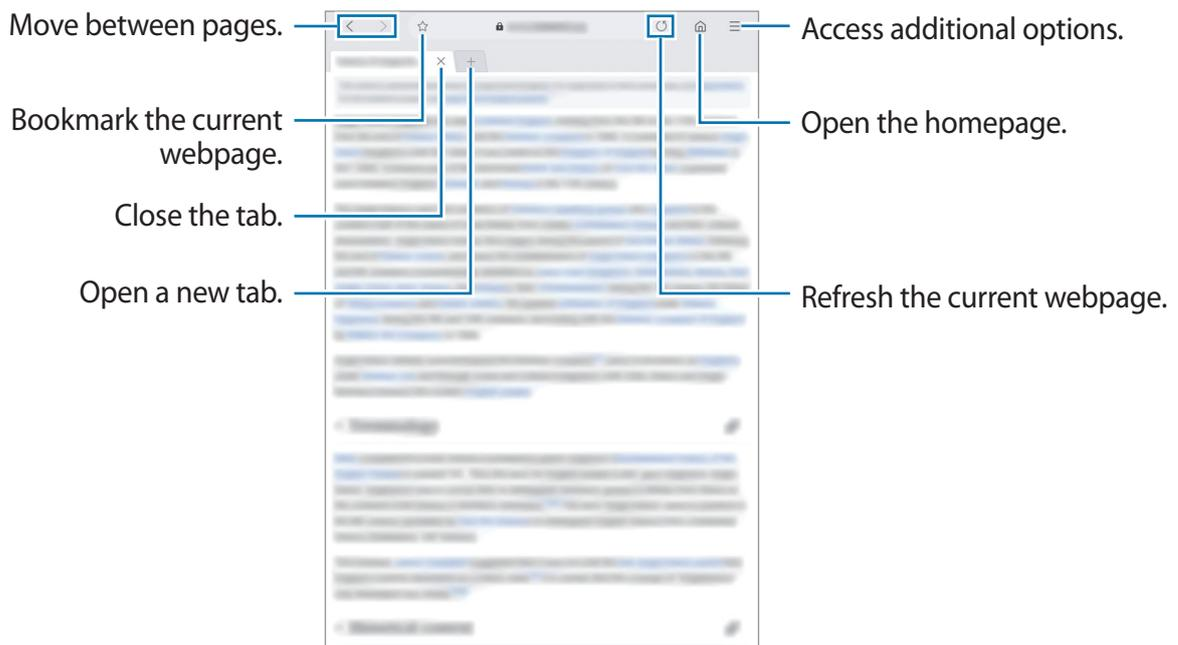

Using secret mode

In secret mode, you can separately manage open tabs, bookmarks, and saved pages. You can lock secret mode using a password and your biometric data.

Activating secret mode

Tap  → **Turn on Secret mode**. If you are using this feature for the first time, set whether to use a password for secret mode.

In secret mode, the device will change the colour of the toolbars.



In secret mode, you cannot use some features, such as screen capture.

Changing security settings

You can change your password or the lock method.

Tap  → **Settings** → **Privacy and security** → **Set Secret mode lock** → **Change password**.

To set your registered biometric data as the lock method along with the password, tap the **Fingerprints** switch to activate it. Refer to [Fingerprint recognition](#) for more information about using your biometric data.

Deactivating secret mode

Tap  → **Turn off Secret mode**.

Email

Setting up email accounts

Set up an email account when opening **Email** for the first time.

- 1 Launch the **Email** app.
- 2 On the list, select an email service or tap **Other**.
- 3 Follow the on-screen instructions to complete the setup.

To set up another email account, tap  →  → **Add account**.

If you have more than one email account, you can set one as the default account. Tap  →  →  → **Set default account**.

Sending emails

- 1 Tap  to compose an email.
- 2 Add recipients and enter a subject line and text.
- 3 Tap  to send the mail.

Reading emails

When **Email** is open, the device will automatically retrieve new emails. To manually retrieve emails, swipe downwards on the top of the emails list.

Tap an email on the screen to read it.



If email syncing is disabled, new emails cannot be retrieved. To enable email syncing, tap  →  → your account name, and then tap the **Sync account** switch to activate it.

Camera

Introduction

Take photos and record videos using various modes and settings.

Camera etiquette

- Do not take photos or record videos of other people without their permission.
- Do not take photos or record videos where legally prohibited.
- Do not take photos or record videos in places where you may violate other people's privacy.

Launching Camera

Use the following methods to launch Camera:

- Launch the **Camera** app.
- On the locked screen, drag  outside the circle.



- Some methods may not be available depending on the region or service provider.
- Some camera features are not available when you launch the **Camera** app from the locked screen or when the screen is turned off while the screen lock method is set.
- If photos you take appear blurry, clean the camera lens and try again.

Basic shooting

Taking photos or recording videos

- 1 On the shooting modes list, tap **Photo** or **Video**.
- 2 Tap the image on the preview screen where the camera should focus.

3 Tap  to take a photo or tap  to record a video.

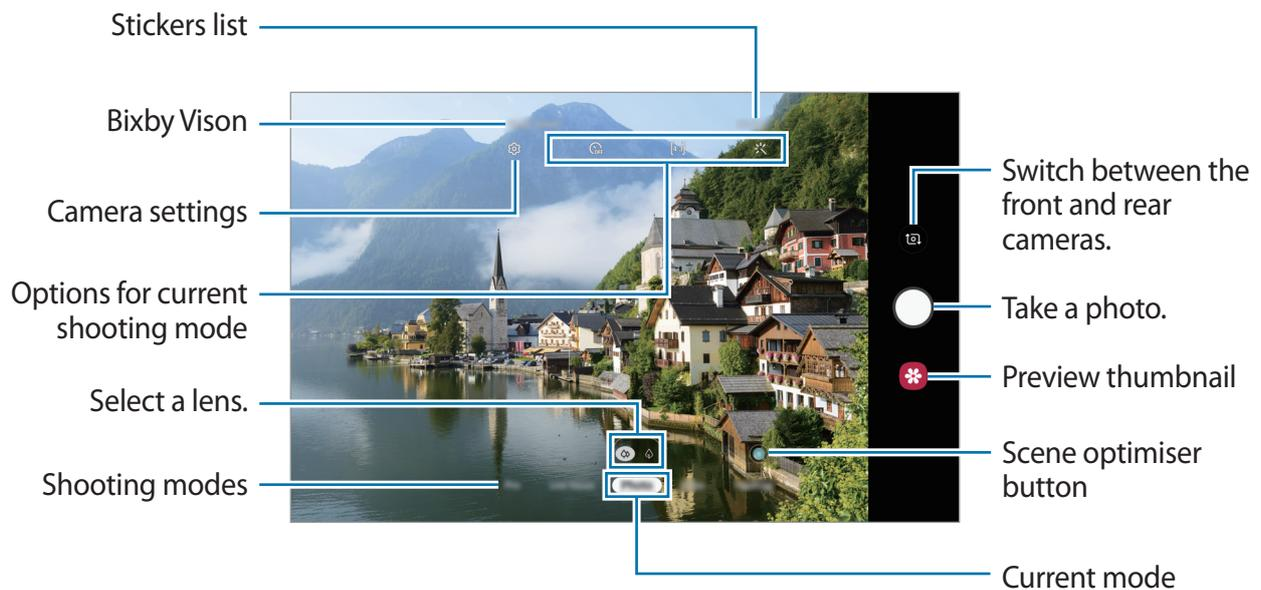

- To adjust the brightness of photos or videos, tap the screen. When the adjustment bar appears, drag  on the adjustment bar towards **+** or **-**.
- To capture an image from the video while recording, tap .
- To change the focus while recording a video, tap where you want to focus. To use auto focus mode, tap .



- The preview screen may vary depending on the shooting mode and which camera is being used.
- The camera automatically shuts off when unused.
- Make sure that the lens is not damaged or contaminated. Otherwise, the device may not work properly in some modes that require high resolutions.
- Your device's camera features a wide-angle lens. Minor distortion may occur in wide-angle photos or videos and does not indicate device performance problems.
- The maximum recording time may reduce when you record video at high resolution.

Selecting a lens for shooting

Take a photo or record a video after selecting the camera lens you want.

On the preview screen, select a lens.



This feature is available only in some modes.

-  : You can take a basic photo or record a normal video with the normal lens.
-  : You can take a photo or record a video much clearer by enlarging the subject with the 2x optical zoom lens.



 Basic shooting



 2x optical zoom shooting

Zooming in and out

Spread two fingers apart on the screen to zoom in, and pinch to zoom out.



- Zooming features are available only when using the rear camera.
- The 2x optical zoom may not work in low-light environments.

Editing the shooting modes list

You can edit the shooting modes list on the preview screen.

- 1 On the preview screen, tap  → **Camera modes** → **Edit modes**.
Alternatively, tap and hold the shooting modes list on the preview screen.
- 2 Tick modes to use.
To change the order of shooting modes, drag  to another location.

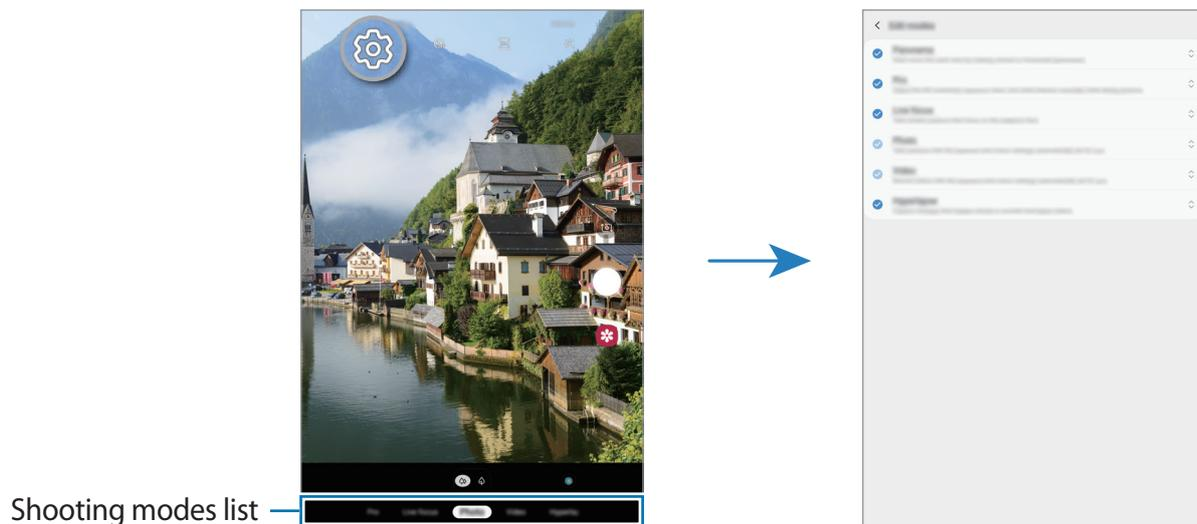

Shooting modes list

Setting the camera button action

You can take a series of photos or create an animated GIF by tapping and holding the camera button.

On the preview screen, tap  → **Hold Shutter button to** and select an action you want to use.

- **Take a picture:** Take a photo.
- **Take burst shot:** Take a series of photos.
- **Create GIF:** Create an animated GIF with sequential photos you taken.



The **Take burst shot** and **Create GIF** features are available only in some shooting modes.

Locking the focus (AF) and exposure (AE)

You can lock the focus or exposure on a selected area to prevent the camera from automatically adjusting based on changes to the subjects or light sources.

Tap and hold the area to focus, the AF/AE frame will appear on the area and the focus and exposure setting will be locked. The setting remains locked even after you take a photo.



This feature is available only in **Photo** or **Pro** modes.

Scene optimiser

Your device will adjust the colour settings automatically after recognising a subject or scene, such as people, food, or night scene.

On the shooting modes list, tap **Photo**. When the camera recognises the subject or scene, the scene optimiser button will change and the optimised colour will be applied.

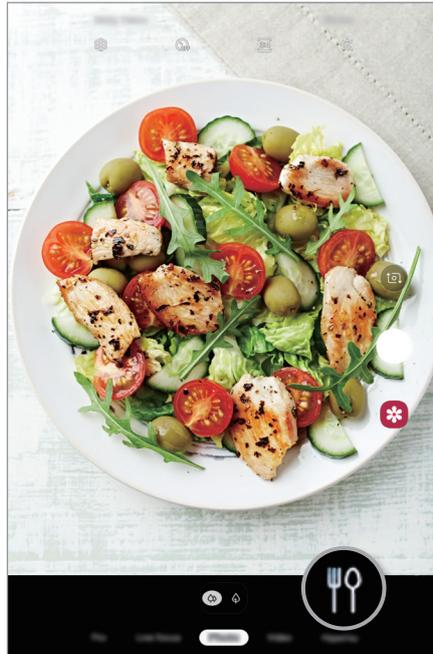

Live focus

The camera allows you to take photos where the background is blurred and the subject stands out clearly.

Taking portraits that stand out using the Live focus feature

Adjust the background blur level on the preview screen and take a photo that highlights the subject.



- Use this feature in a place that has sufficient light.
- The background blur may not be applied properly in the following conditions:
 - The device or the subject is moving.
 - The subject is thin or transparent.
 - The subject has a similar colour or pattern to the background.
 - The subject or background is plain.

- 1 On the shooting modes list, tap **Live focus**.
- 2 Drag the background blur adjustment bar to the left or right to adjust the blur level.

3 When **Effect ready.** appears on the preview screen, tap  to take a photo.

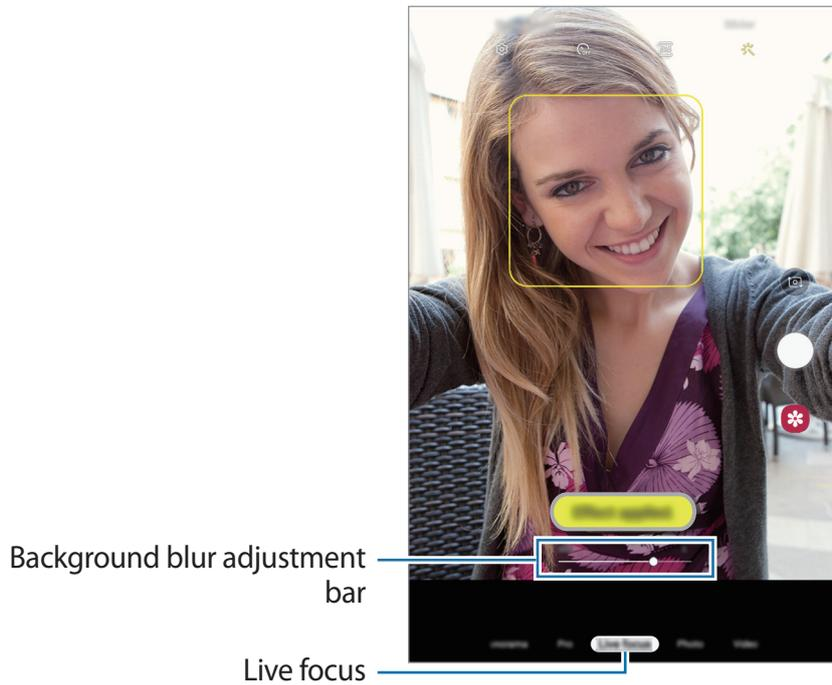

Editing the background of the Live Focus photos

You can also edit the background blur level of a photo taken with the Live focus feature.

- 1 Select a photo taken with the Live focus feature and tap **Change background effect.**
- 2 Drag the background blur adjustment bar to the left or right to adjust the blur level.



3 Tap **Apply** to save the photo.

Live stickers

Capture photos and videos with various live stickers. As you move your face, stickers will track with your movements. You can also record a lovely and funny sticker that keeps moving in a video.

- 1 On the preview screen, tap **Sticker**.
- 2 Tap 🍷 and select a sticker you want.



- 3 Tap ○ to take a photo or tap ● to record a video.

Using shooting modes

To change the shooting mode, drag the shooting modes list to the left or right, or swipe to the left or right on the preview screen.

Select a shooting mode you want.

Photo mode

The camera adjusts the shooting options automatically based on the surroundings to capture photos easily.

On the shooting modes list, tap **Photo**.

To take self-portraits with the front camera, swipe upwards or downwards, or tap  to switch to the front camera.

Applying beauty effects

You can select a filter effect and also modify your facial features, such as your skin tone or face shape, before taking a self-portrait.

- 1 On the preview screen, tap .
- 2 Select a filter effect or beauty effects and take a photo.

Video mode

The camera adjusts the shooting options automatically based on the surroundings to record videos easily.

On the shooting modes list, tap **Video**.

Hyperlapse mode

Record scenes, such as passing people or cars, and view them as fast-motion videos.

- 1 On the shooting modes list, tap **Hyperlapse**.
- 2 Tap  and select a frame rate option.

If you set the frame rate to **Auto**, the device will automatically adjust the frame rate according to the changing rate of the scene.

- 3 Tap  to start recording.
- 4 Tap  to finish recording.
- 5 On the preview screen, tap the preview thumbnail and tap **Play hyperlapse** to view the video.

Pro mode

Capture photos while manually adjusting various shooting options, such as exposure value and ISO value.

On the shooting modes list, tap **Pro**. Select options and customise the settings, and then tap  to take a photo.

Available options

-  : Select an ISO value. This controls camera light sensitivity. Low values are for stationary or brightly lit objects. Higher values are for fast-moving or poorly lit objects. However, higher ISO settings can result in noise in photos.
-  : Select an appropriate white balance, so images have a true-to-life colour range. You can set the colour temperature.
-  : Change the exposure value. This determines how much light the camera's sensor receives. For low-light situations, use a higher exposure.

Panorama mode

Using panorama mode, take a series of photos and then stitch them together to create a wide scene.



To get the best shots using panorama mode, follow these tips:

- Move the camera slowly in one direction.
- Keep the image within the frame on the camera's viewfinder. If the preview image is out of the guide frame or you do not move the device, the device will automatically stop taking photos.
- Avoid taking photos of indistinct backgrounds, such as an empty sky or a plain wall.

- 1 On the shooting modes list, tap **Panorama**.
- 2 Tap  and move the device slowly in one direction.
- 3 Tap  to stop taking photos.

Customising camera settings

Options for current shooting mode

On the preview screen, use the following options.



The available options may vary depending on the shooting mode.

-  : Activate or deactivate the flash.



Do not use the flash close to your eyes. Using a flash close to the eyes may cause temporary loss of vision or damage to the eyes.

-  : Select the length of the delay before the camera automatically takes a photo.
-  : Select an aspect ratio for photos.
-  : Apply beauty effects or a filter effect.
-  : Select a frame rate.
-  : Select an aspect ratio for videos.
-  : Select a metering method. This determines how light values are calculated.  **Centre-weighted** uses the light in the centre portion of the shot to calculate the exposure of the shot.  **Spot** uses the light in a concentrated centre area of the shot to calculate the exposure of the shot.  **Matrix** averages the entire scene.

Camera settings

On the preview screen, tap . Some options may not be available depending on the shooting mode.

Intelligent features

- **Scene optimiser:** Set the device to adjust the colour settings automatically depending on the subject or scene.

Pictures

- **Hold Shutter button to:** Select an action to perform when you tap and hold the camera button.
- **Save options:** Select how you want to save photos.

Videos

- **Rear video size:** Select a resolution for videos you want to take with the rear camera. Using a higher resolution will result in higher quality videos, but they will take up more memory.
- **Front video size:** Select a resolution for videos you want to take with the front camera. Using a higher resolution will result in higher quality videos, but they will take up more memory.
- **High efficiency video:** Activate the High efficiency video feature, you can record videos in the High Efficiency Video Codec (HEVC) format. Your HEVC videos will be saved as compressed files to conserve the device's memory.



You cannot play the HEVC videos on other devices or share them online.

Useful features

- **HDR (rich tone):** Take photos with rich colours and reproduce details even in bright and dark areas.
- **Grid lines:** Display viewfinder guides to help composition when selecting subjects.
- **Location tags:** Attach a GPS location tag to the photo.
 -  GPS signal strength may decrease in locations where the signal is obstructed, such as between buildings or in low-lying areas, or in poor weather conditions.
 - Your location may appear on your photos when you upload them to the Internet. To avoid this, deactivate the location tag setting.
- **Camera modes:** View available shooting modes or edit the shooting modes list.
- **Shooting methods:** Select a shooting method for taking a photo or recording a video.
- **Storage location:** Select the memory location for storage. This feature will appear when you insert a memory card.
- **Reset settings:** Reset the camera settings.
- **Contact us:** Ask questions or view frequently asked questions. Refer to [Samsung Members](#) for more information.
- **About Camera:** View the Camera app version and legal information.

Gallery

Introduction

View images and videos stored in your device. You can also manage images and videos by album or create stories.

Viewing images

1 Launch the **Gallery** app and tap **Pictures**.

2 Select an image.

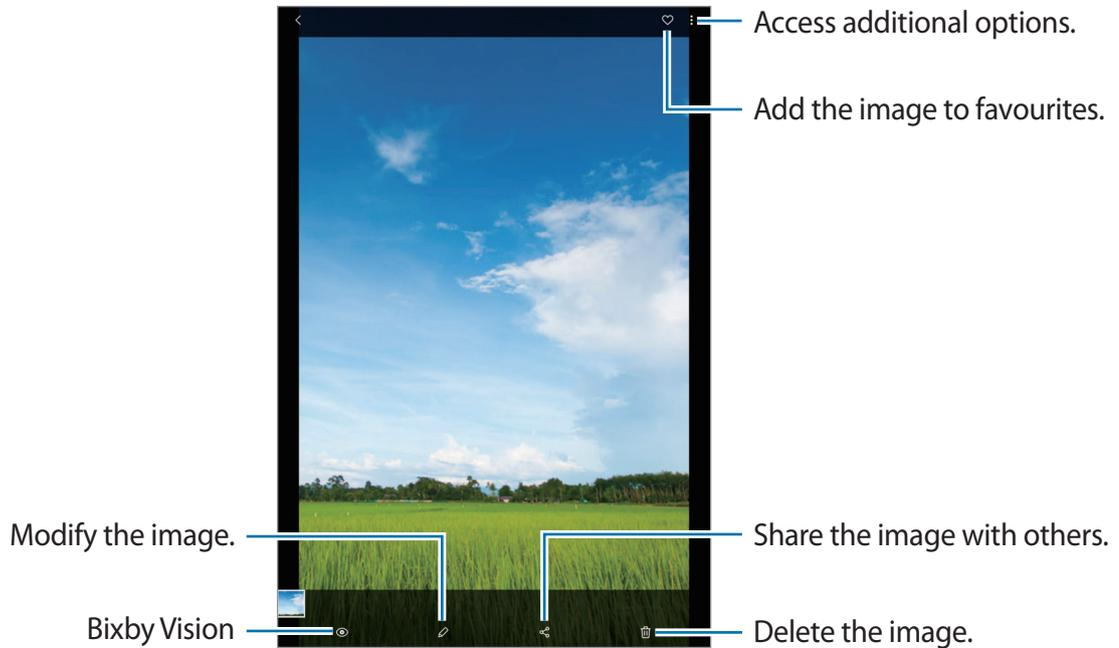

You can create an animated GIF or collage from multiple images. On the list, tap **⋮** → **Create GIF** or **Create collage**, and then select images.

Searching for images

Launch the **Gallery** app and tap **🔍** to view images sorted by category, such as types, locations, or documents.

To search for images by entering keywords, tap the search field.

Editing the background of Live focus photos

You can edit the background blur level of a photo taken with the Live focus feature.

Launch the **Gallery** app, select a photo taken with the Live focus feature, tap **Change background effect** to edit the blur level.

Viewing videos

- 1 Launch the **Gallery** app and tap **Pictures**.
- 2 Select a video to play.
- 3 Tap **Play video** to play the video.

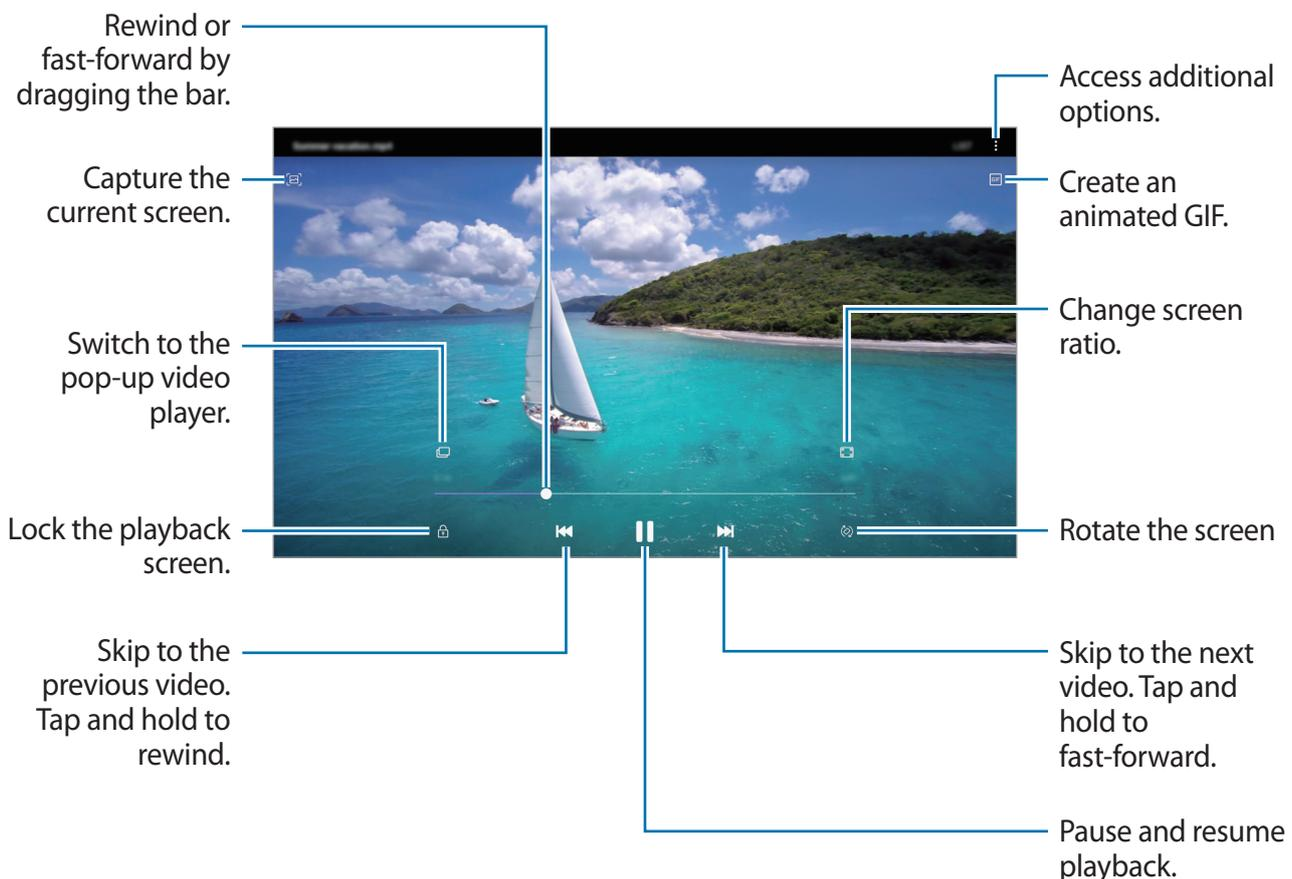

Drag your finger up or down on the left side of the playback screen to adjust the brightness, or drag your finger up or down on the right side of the playback screen to adjust the volume.

To rewind or fast-forward, swipe to the left or right on the playback screen.

Viewing the details of images and videos

You can view file details, such as people, location, and basic information. If there is auto created content, such as a story or a GIF, the content will also be displayed.

While viewing an image or on the video preview screen, drag upwards on the screen. File details will appear.

You can also view related content by tapping information on the screen.

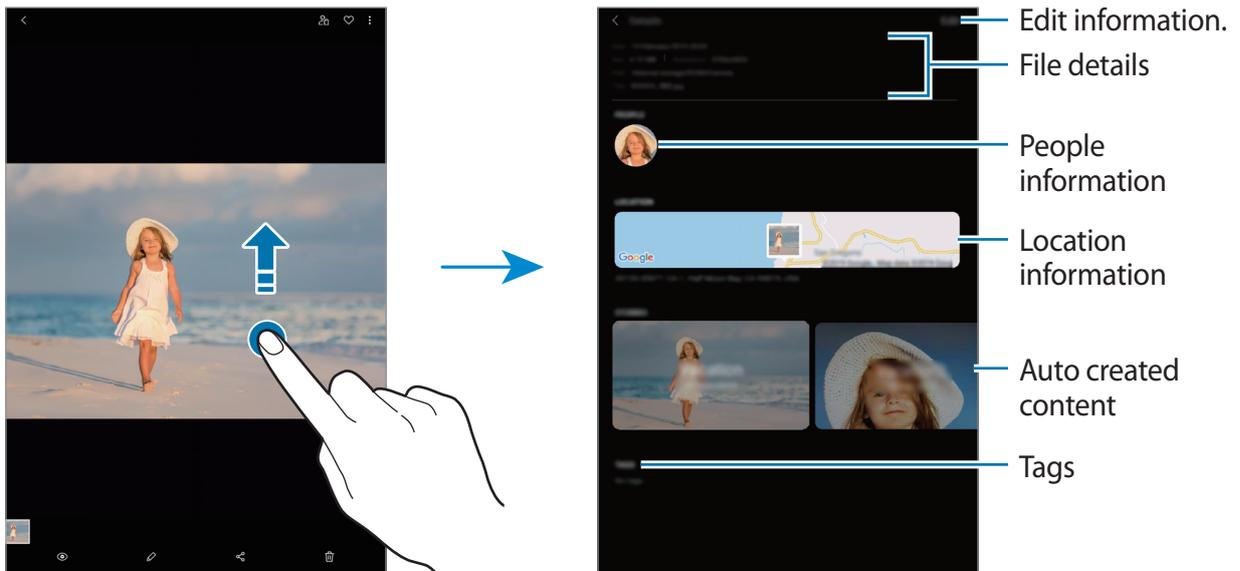

Viewing albums

You can view your images and videos sorted by folders or albums. The animated GIFs or collages that you have created will also be sorted in your folders on the albums list.

Launch the **Gallery** app, tap **Albums**, and then select an album.

Hiding albums

You can hide albums.



You cannot hide albums created by default, such as the **Camera** and **Screenshots** albums.

- 1 Launch the **Gallery** app and tap **Albums**.
- 2 Tap **⋮** → **Hide or unhide albums**.
- 3 Tap an album switch to hide.

Viewing stories

When you capture or save images and videos, the device will read their date and location tags, sort the images and videos, and then create stories. To create stories automatically, you must capture or save multiple images and videos.

Launch the **Gallery** app, tap **Stories**, and then select a story.

Creating stories

Create stories with various themes.

- 1 Launch the **Gallery** app and tap **Stories**.
- 2 Tap **⋮** → **Create story**.
- 3 Enter a title for the story and tap **Create**.
- 4 Tick images or videos to include in the story and tap **Done**.

To add images or videos to a story, select a story and tap  → **Add**.

To remove images or videos from a story, select a story, tap  → **Edit**, tick images or videos to remove, and then tap **Remove from story**.

Deleting stories

- 1 Launch the **Gallery** app and tap **Stories**.
- 2 Tap and hold a story to delete, and tap **Delete**.

Sharing albums

Create albums and share them with your family and friends saved in your contacts. They can view shared albums on devices signed in to their Samsung account, such as smartphones, TVs, or refrigerators.



- To use this feature, your phone number must be verified. (SM-T725)
- To use this feature, you must register and sign in to your Samsung account.
- You may incur additional charges when sharing files via the mobile network. (SM-T725)
- To use this feature, launch the **Settings** app, tap **Connections**, and then tap the **Call & Message Continuity** switch to activate it. You must register and sign in to the same Samsung account on your device and the other device. (SM-T720)

Creating albums to share

- 1 Launch the **Gallery** app and tap **Shared**.
- 2 Tap **Create shared album**.
When using this feature for the first time, you must first agree to the terms and conditions of Samsung Social.
- 3 Enter a title for the album and tap **Create**.
- 4 Select a group to share with.
- 5 Tap **OK**.
The recipients will receive a notification.

Adding images or videos to an album

- 1 Launch the **Gallery** app and tap **Shared**.
- 2 Select an album to add images or videos.
- 3 Tap **+** and tick images or videos to add.
- 4 Tap **Done**.

Syncing images and videos with Samsung Cloud

When you sync your **Gallery** app with Samsung Cloud, photos and videos you take will also be saved in Samsung Cloud. You can view images and videos saved in Samsung Cloud in your **Gallery** app and from other devices.

Launch the **Gallery** app, tap **⋮** → **Settings**, and then tap the **Sync with Samsung Cloud** switch to activate it. The **Gallery** app and Samsung Cloud will be synced.

Deleting images or videos

Deleting an image or a video

Select an image or a video and tap **🗑** at the bottom of the screen.

Deleting multiple images and videos

- 1 On the Gallery screen, tap and hold an image or a video to delete.
- 2 Tick the images or videos to delete.
- 3 Tap **Delete**.

Multi window

Introduction

Multi window lets you run two apps at the same time in the split screen view. You can also run multiple apps at the same time in the pop-up view.



Some apps may not support this feature.



Split screen view

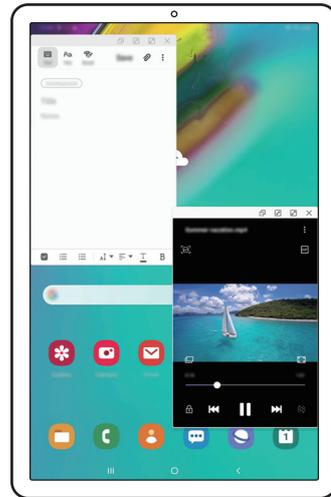

Pop-up view

Split screen view

- 1 Tap the Recents button to open the list of recently used apps.
- 2 Swipe to the left or right, tap an app's icon, and then tap **Open in split screen view**.
The selected app will launch in the upper window.

3 On the lower window, swipe left or right to select another app to launch.

To launch apps not on the list of recently used apps, tap the Home button or Back button and select an app.

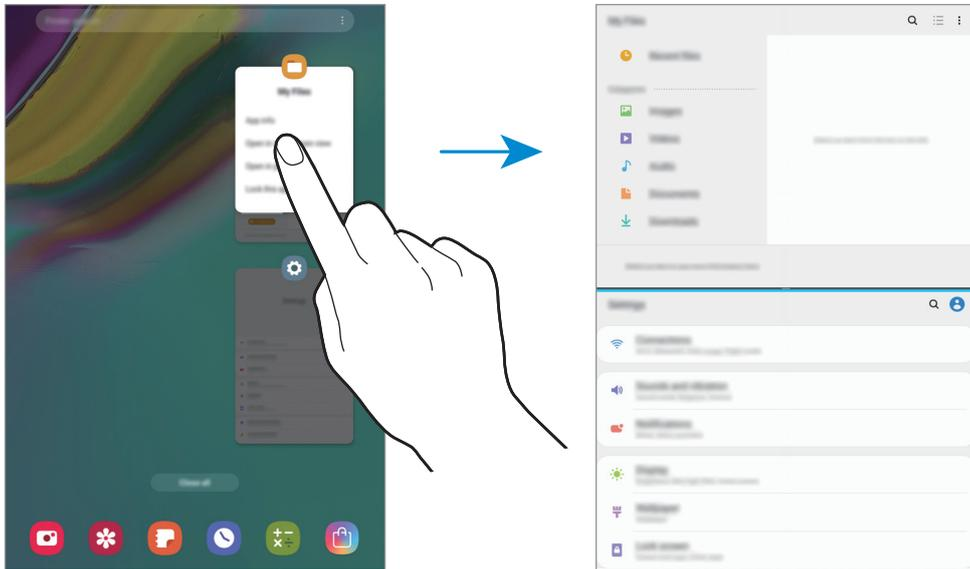

Adjusting the window size

Drag the bar between the app windows up or down to adjust the size of the windows.

When you drag the bar between the app windows to the top or bottom edge of the screen, the window will be maximised.

Pop-up view

- 1 Tap the Recents button to open the list of recently used apps.
- 2 Swipe to the left or right, tap an app's icon, and then tap **Open in pop-up view**.
The app screen will appear in the pop-up view.

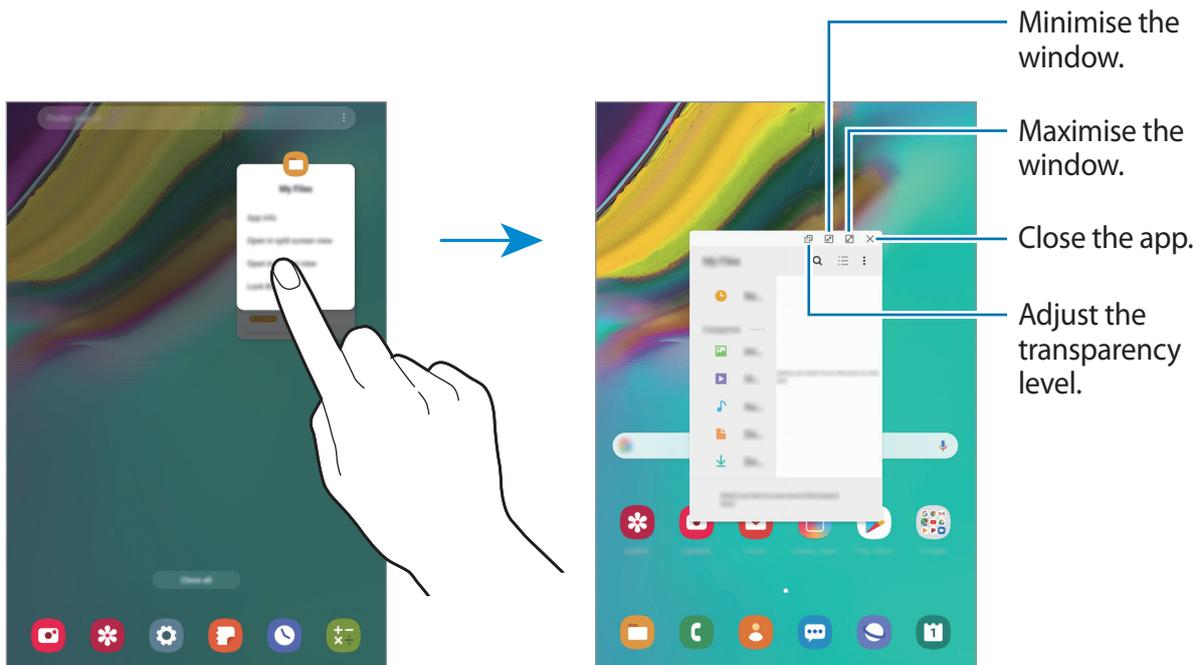

Moving pop-up windows

To move a pop-up window, tap the window's toolbar and drag it to a new location.

Kids Home

Introduction

You can restrict children’s access to certain apps, set their usage times, and configure settings to provide a fun and safe environment for children when they use the device.

Starting Kids Home

When starting Kids Home for the first time or after performing a data reset, follow the on-screen instructions to complete the setup.

- 1 Open the notification panel, swipe downwards on the notification panel, and then tap  (**Kids Home**) to activate it.

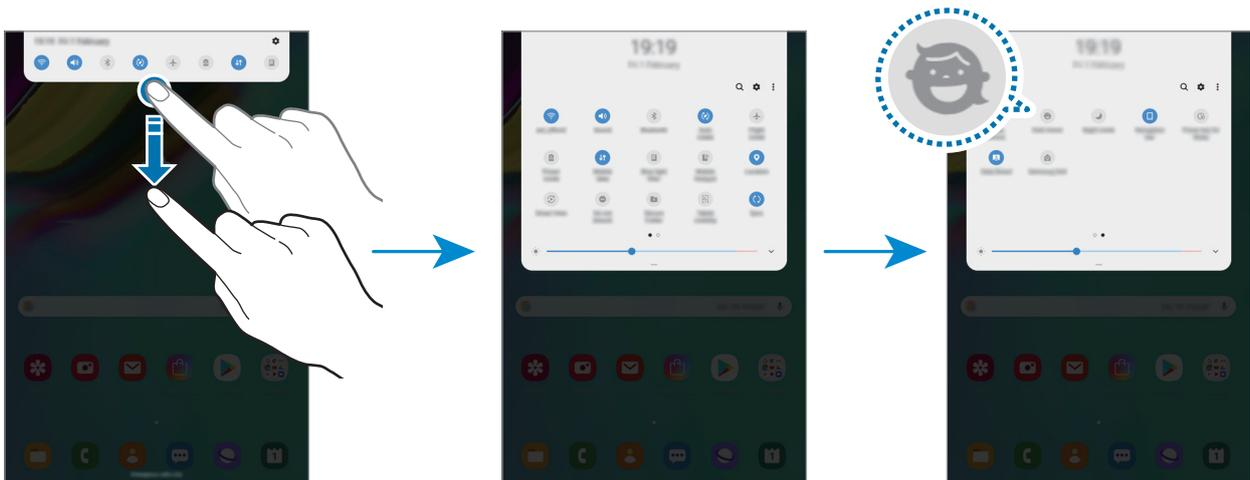

- 2 Read the Kids Home intro page and tap **Next**.

- 3 Create a PIN to use when using Kids Home.

If you have already set the screen lock method on your device, you can use the same lock method for Kids Home.

The Kids Home screen will appear.



The created PIN will be used when activating the **Parental control** feature or closing Kids Home.

Using Kids Home

Open the notification panel, swipe downwards on the notification panel, and then tap  (**Kids Home**) to activate it.

The Kids Home screen will appear.

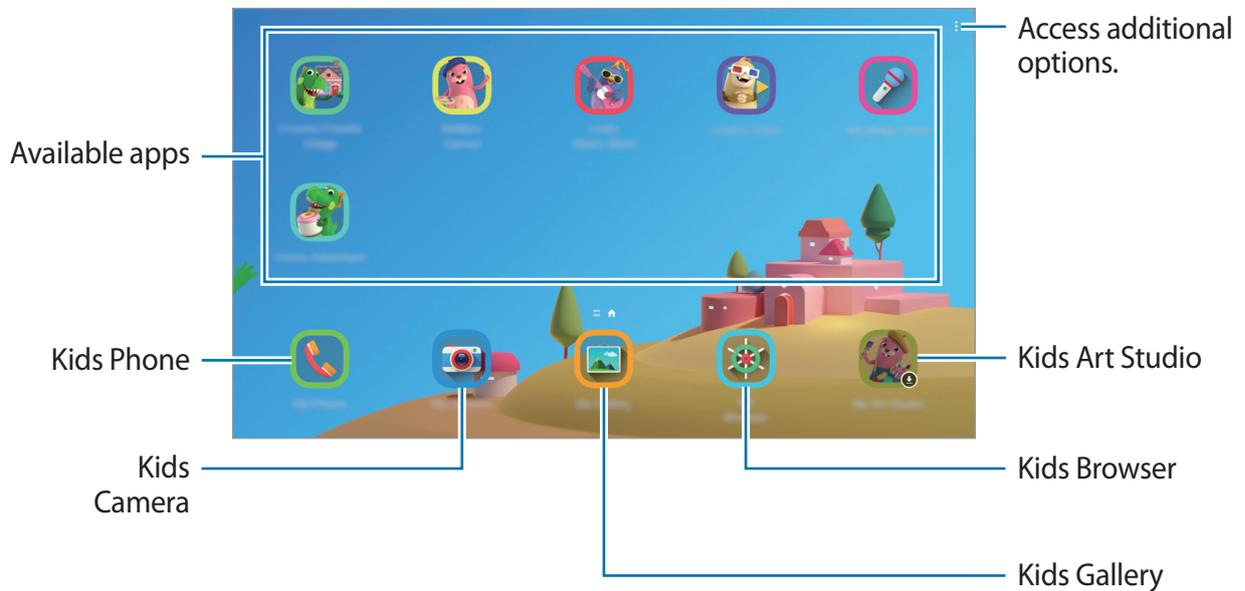

Configuring settings for Kids Home

On the Kids Home screen, tap  → **Parental control** and enter the PIN.

- **Kid's name:** Manage your child's profile.
- **Set daily playtime:** Restrict the usage time for Kids Home.
- **Daily usage:** View the daily usage time of Kids Home.
- **Activity:** View the activity history of Kids Home.
- **Frequently contacted:** View the frequently used contacts in Kids Home.
- **My kid's creations:** View the works created from the apps in Kids Home.
- **Allowed content:** Check the apps or content supported by Kids Home and add them.

Closing Kids Home

To close Kids Home, tap the Back button or tap  → **Close Kids Home**, and then enter your PIN.

Samsung Members

Samsung Members offers support services to customers, such as device problem diagnosis, and lets users submit questions and error reports. You can also share information with others in the Galaxy users' community or view the latest Galaxy news and tips. **Samsung Members** can help you solve any problems you might encounter while using your device.



- This app's availability and supported features may vary depending on the region or service provider.
- To submit your feedback or post your comments, you must register and sign in to your Samsung account. Refer to [Samsung account](#) for more information.

Samsung Notes

Create notes by entering text from the keyboard or by handwriting or drawing on the screen. You can also insert images or voice recordings into your notes.

Creating notes

- 1 Launch the **Samsung Notes** app and tap .
- 2 Select an input method from the toolbar at the top of the screen and compose a note.

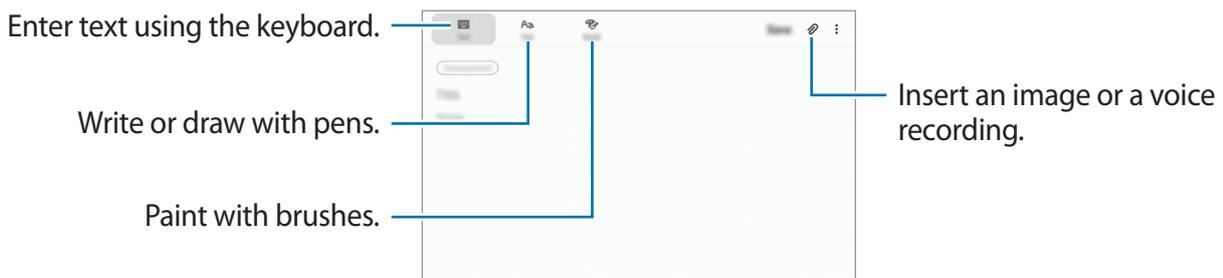

- 3 When you are finished composing the note, tap **Save**.

Deleting notes

- 1 Launch the **Samsung Notes** app.
- 2 Tap and hold a note to delete.
To delete multiple notes, tick more notes to delete.
- 3 Tap **Delete**.

Calendar

Manage your schedule by entering upcoming events or tasks in your planner.

Creating events

- 1 Launch the **Calendar** app and tap **+** or double-tap a date.
If the date already has saved events or tasks in it, tap the date and tap **+**.
- 2 Enter event details.

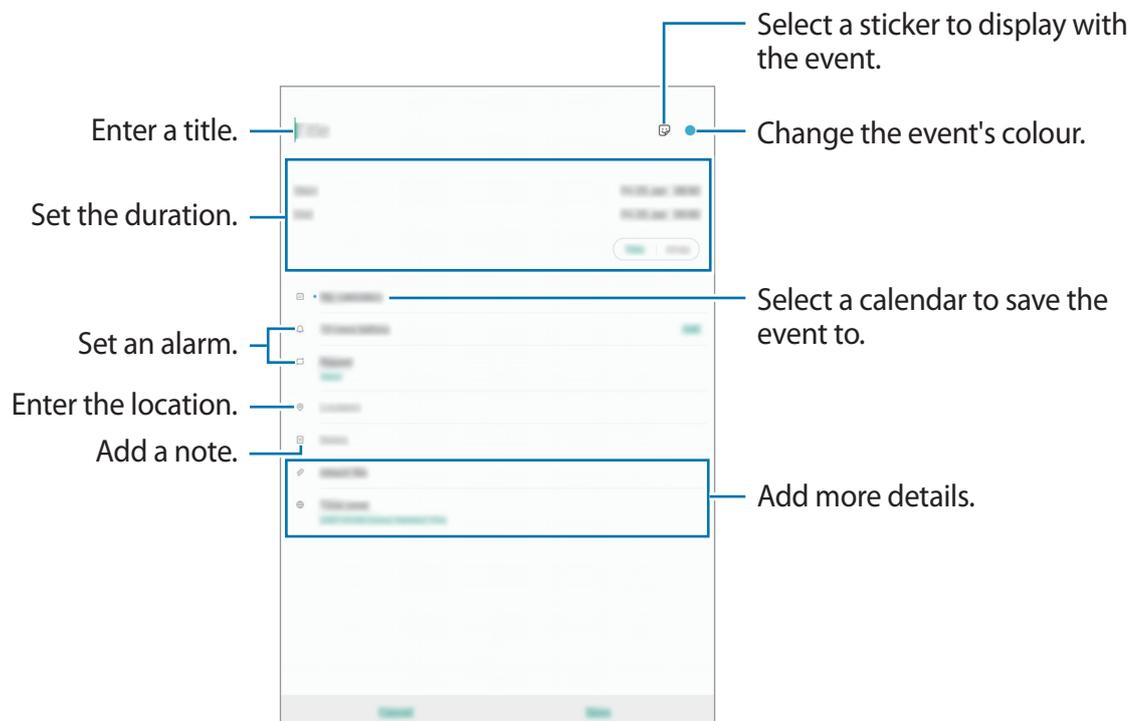

- 3 Tap **Save** to save the event.

Adding a reminder

Launch the **Calendar** app and tap  → **Reminder** to launch the **Reminder** app. Add a task on the **Reminder** app. Refer to [Reminder](#) for more information.

Syncing events with your accounts

- 1 Launch the **Settings** app, tap **Accounts and backup** → **Accounts** and select the account to sync with.
- 2 Tap **Sync account** and tap the **Calendar** switch to activate it.
For the Samsung account, tap  → **Sync settings** and tap the **Calendar** switch to activate it.

To add accounts to sync with, launch the **Calendar** app and tap  →  → **Add new account**. Then, select an account to sync with and sign in. When an account is added, it will appear on the list.

Samsung Flow

Introduction

Samsung Flow allows you to easily connect your tablet to your smartphone and use them conveniently, such as checking notifications or sharing contents.

Samsung Flow must be installed on both devices that you want to connect. If Samsung Flow is not installed, download it from **Galaxy Store** or **Play Store**.



- This feature is only available on some Samsung Android devices.
- To use this feature, you must activate Bluetooth feature on your tablet and your smartphone.

Connecting your tablet and smartphone

- 1 On your smartphone, launch Samsung Flow.
- 2 On your tablet, launch the **Samsung Flow** app.



If you are using this feature for the first time, tap **START**.

- 3 Tap **SCAN FOR DEVICES**.
- 4 Select your smartphone from the detected devices list.
- 5 Accept the connection request on both devices.
- 6 Confirm the passkey on both devices.
The devices will be connected.



If your smartphone supports fingerprint recognition feature, set up Samsung Pass on your smartphone to connect the devices more easily and securely using your fingerprint.

Sharing mobile data connection

Share your smartphone's mobile data connection with your tablet using a mobile hotspot when the Internet connection is not available on your tablet.

- 1 On your tablet, launch the **Samsung Flow** app.
- 2 Tap .

You can access the Internet on your tablet using your smartphone's mobile data connection.



- Your smartphone must support the mobile hotspot feature.
- You may incur additional charges on your smartphone when using this feature.

Checking notifications on your tablet

When you receive new notifications on your smartphone, check the notifications in pop-up window on your tablet.

Sharing contents

You can share your smartphone's contents with your tablet.

My Files

Access and manage various files stored in the device or in other locations, such as cloud storage services.

Launch the **My Files** app.

View files that are stored in each storage.

To check for unnecessary data and free up the device's storage, tap  → **Storage analysis**.

To search for files or folders, tap **Q**.

Clock

Introduction

Set alarms, check the current time in many cities around the world, time an event, or set a specific duration.

Alarm

Launch the **Clock** app and tap **Alarm**.

Setting alarms

Tap **+** in the alarms list, set an alarm time, select the days on which the alarm will repeat, set other various alarm options, and then tap **Save**.

To open the keypad to enter an alarm time, tap the time input field.

To activate or deactivate alarms, tap the switch next to the alarm in the alarms list.

Stopping alarms

Tap **Dismiss** to stop an alarm. If you have previously enabled the snooze option, tap **Snooze** to repeat the alarm after a specified length of time.

Deleting alarms

Tap and hold an alarm, tick alarms to delete, and then tap **Delete**.

World Clock

Launch the **Clock** app and tap **World Clock**.

Creating clocks

Tap **+**, enter a city name or select a city from the map, and then tap **Add**.

To use the time zone converter, tap **⋮** → **Time zone converter**.

Deleting clocks

Tap and hold a clock, tick clocks to delete, and then tap **Delete**.

Stopwatch

- 1 Launch the **Clock** app and tap **Stopwatch**.
- 2 Tap **Start** to time an event.
To record lap times while timing an event, tap **Lap**.
- 3 Tap **Stop** to stop timing.
To restart the timing, tap **Resume**.
To clear lap times, tap **Reset**.

Timer

- 1 Launch the **Clock** app and tap **Timer**.
To add a frequently used timer, tap **+**, set the duration and name, and then tap **Add**.
- 2 Set the duration, and then tap **Start**.
To open the keypad to enter the duration, tap the duration input field.
- 3 Tap **Dismiss** when the timer goes off.

Calculator

Perform simple or complex calculations.

Launch the **Calculator** app.

You can see the calculation history at the upper part of the screen.

To clear the history, tap **Clear history**.

To use the unit conversion tool, tap . You can convert various values, such as area, length, or temperature, into other units.

Game Launcher

Introduction

Game Launcher gathers your games downloaded from **Play Store** and **Galaxy Store** into one place for easy access. You can set the device to game mode to play games more easily.

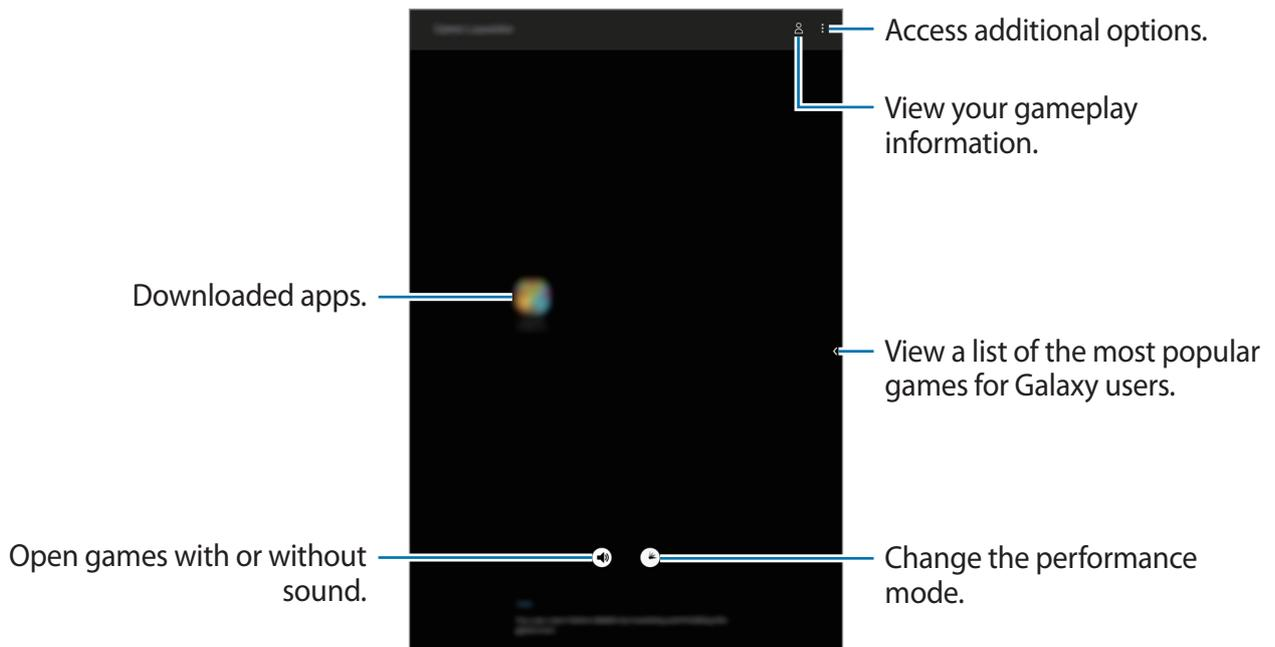

Using Game Launcher

1 Launch the **Game Launcher** app.



If **Game Launcher** does not appear, launch the **Settings** app, tap **Advanced features**, and then tap the **Game Launcher** switch to activate it.

2 Tap a game from the games list.

To find more games, swipe to the left on the screen.



Games downloaded from **Play Store** and **Galaxy Store** will be automatically shown on the Game Launcher screen. If you cannot see your games, tap **⋮** → **Add apps**.

Removing a game from Game Launcher

Tap and hold a game and tap **Remove from Game Launcher**.

Changing the performance mode

You can change the game performance mode.

Launch the **Game Launcher** app, tap , and then drag the bar to select the mode you want.

- **Focus on power saving:** This saves battery power while playing games.
- **Balanced:** This balances the performance and the battery usage time.
- **Focus on performance:** This focuses on giving you the best possible performance while playing games.

To change the settings for each game, tick the **Settings for each game** and tap **Apply**.



Battery power efficiency may vary by game.

Using Game Tools

You can use various options on the Game Tools panel while playing a game. To open the Game Tools panel, tap  on the navigation bar. If the navigation bar is hidden, drag upwards from the bottom of the screen to show it.

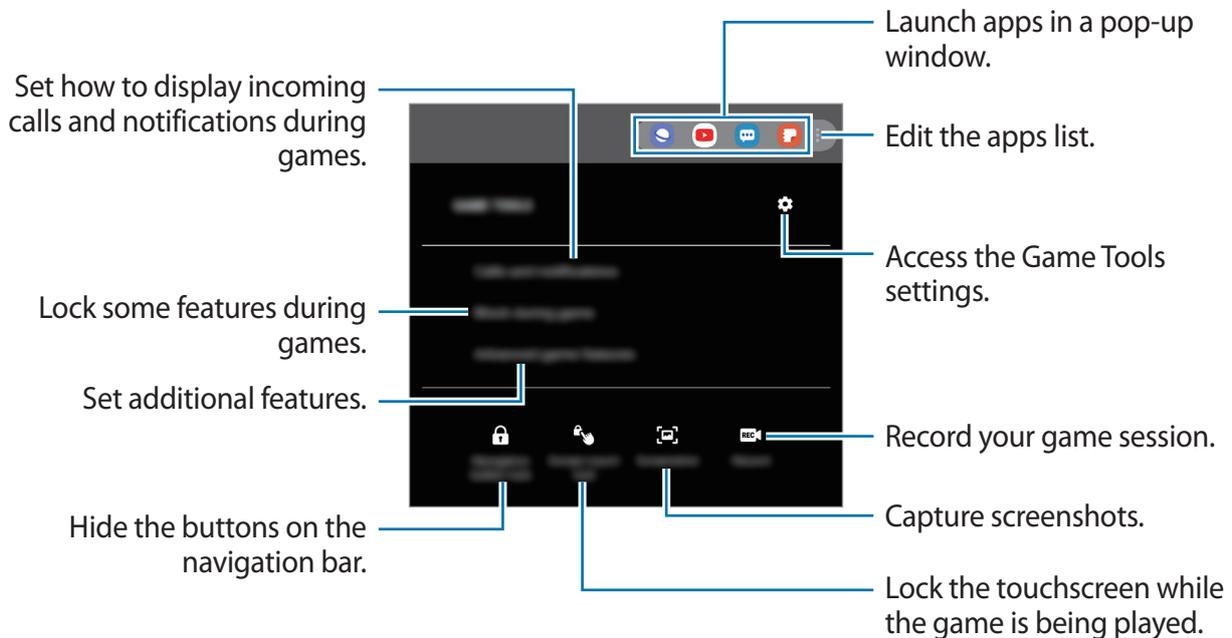

Available options may vary depending on the game.

Setting how to display incoming calls and notifications during games

You can enjoy your games without being disturbed even when you receive a call or notification.

Tap  → **Calls and notifications** and select an option to activate it.

- **Minimised caller notifications:** A small notification will appear at the top of the screen when you receive a call during games.
- **Don't display notifications:** Only display notifications from some apps or emergency notifications during games.



To use **Calls and notifications** feature, launch the **Settings** app, tap **Connections**, and then tap the **Call & Message Continuity** switch to activate it. You must register and sign in to the same Samsung account on your device and the other device. (SM-T720)

Bixby Vision

Introduction

Bixby Vision is a service that provides various features based on image recognition.

You can use Bixby Vision to quickly search for information by recognising objects or your current location. You can also experience the AR feature, which makes virtual images appear on the preview screen.

Use a variety of useful Bixby Vision features.

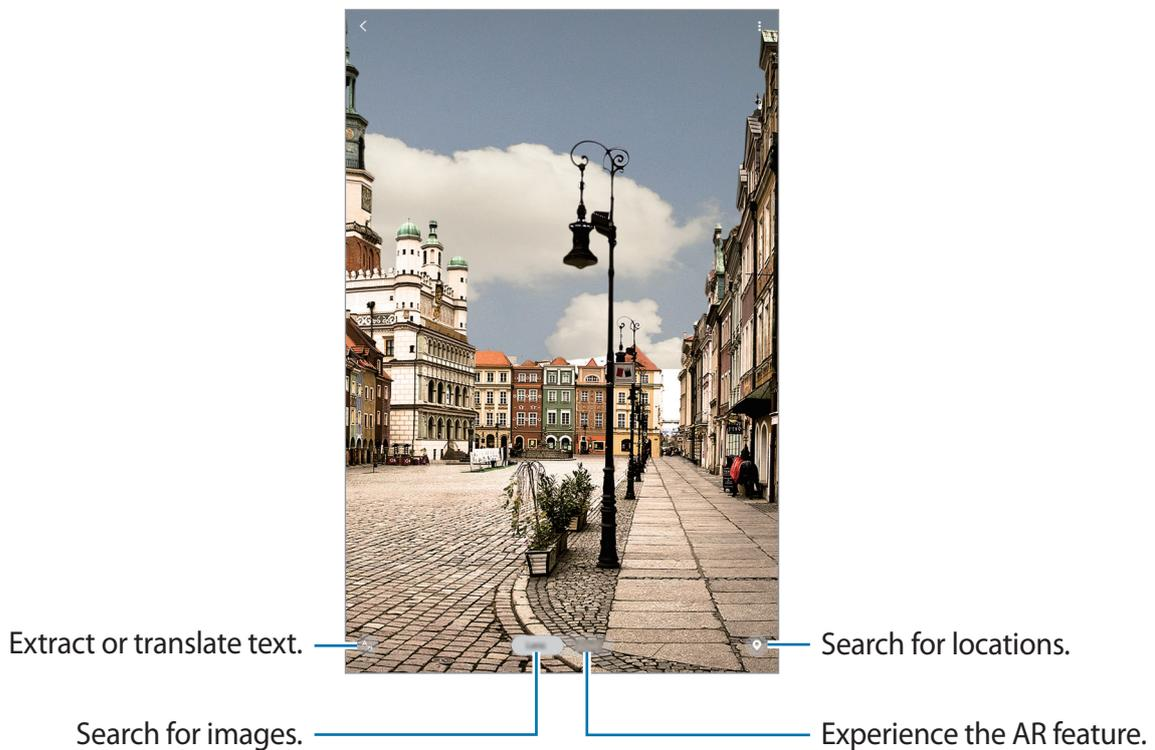

- To use this feature, the device must be connected to a Wi-Fi or mobile network.
- To use some Bixby Vision features, you must sign in to your Samsung account.
- The available features and search results may vary depending on the region or service provider.
- This feature may not be available or you may not get correct search results depending on the image size, format, or resolution.
- Samsung is not responsible for the product information provided by Bixby Vision.

Launching Bixby Vision

Launch Bixby Vision using one of these methods.

- In the **Camera** app, tap **Bixby Vision**.
- In the **Gallery** app, select an image and tap .
- In the **Internet** app, tap and hold an image and tap **Bixby Vision**.
- If you added the Bixby Vision app icon to the Home screen and Apps screen, launch the **Bixby Vision** app.

Searching for similar images

Search for images similar to the recognised object online. You can view various images with properties similar to the object, such as colour or shape.

For example, if you want to know the title of a photo or image, use the Bixby Vision features. The device will search for and show you related information or images with similar characteristics.

- 1 Launch the **Camera** app and tap **Bixby Vision**.
- 2 Tap **Lens** and keep the object within the screen to recognise it.
- 3 Select a search result with  on it.
The similar images will appear.

Translating or extracting text

Recognise and show the translated text on the screen. You can also extract text from a document or an image file.

For example, if you want to know what a sign says while travelling abroad, use the Bixby Vision features. The device will translate the sign's text into the language you select.

1 Launch the **Camera** app and tap **Bixby Vision**.

2 Tap  and keep the text within the screen to recognise it.

The translated text will appear on the screen.

- To extract text, tap . You can share or save the extracted text.
- To save the screen with the translated text as an image, tap . The screen will be saved in **Gallery**.
- To change the source or target language, tap the language settings panel at the top of the screen.

Searching for places and deals

Search for information about nearby places by recognising your current location. You can also view deals available nearby.

For example, if you want to search for nearby stores having sales, use the Bixby Vision features. The device will search for and show you the sales happening in the nearby stores.

1 Launch the **Camera** app and tap **Bixby Vision**.

2 Tap  and point the camera towards the direction you want to search for places.

You can view basic information about nearby places.

- If you want to search for places in another direction, point the camera towards the direction.
- To view available deals nearby, tap **Deals**.
- You can view your current location and weather information. To view your current location on the map, point the camera towards the ground. To view the current weather information, point the camera towards the sky.

3 Select a search result on the screen.

The device will show the information of nearby places and deals.

Experiencing various AR features

Various apps include the AR feature, which makes virtual images appear on the background or person on the preview screen. You can conveniently experience products and view information without visiting stores or trying them in person. Experience Bixby Vision's fun and useful AR feature.



Available apps may vary depending on the region or service provider.

- 1 Launch the **Camera** app and tap **Bixby Vision**.
- 2 Tap **Apps** and select the feature you want.

Bixby Home

On the Bixby Home screen, you can view recommended services and information that Bixby provides by analysing your usage patterns and your routine.



- To view more content, connect to a Wi-Fi or mobile network.
- To fully use this feature, you must register and sign in to your Samsung account.

Opening Bixby Home

- 1 On the Home screen, swipe to the right.

The Bixby Home screen will appear.

When launching this feature for the first time or after performing a data reset, follow the on-screen instructions to complete the setup.

2 Swipe upwards or downwards to view recommended content.

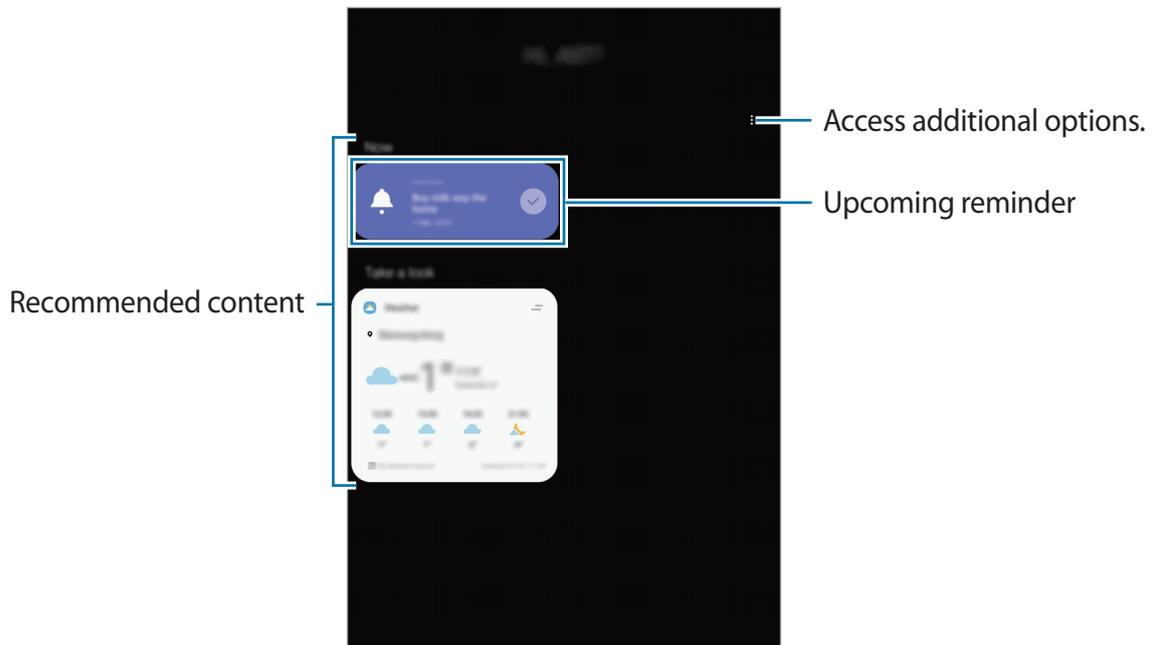

3 To close Bixby Home, swipe to the left on the screen or tap the Back button.

Using recommended content on Bixby Home

When you open Bixby Home, you can view the content that is frequently updated as cards. Swipe upwards or downwards to view the cards.

For example, on the way to the office in the morning, you can view your day's schedule and play your favourite music on the Bixby Home screen. In the evening, you can view alarms, check your daily activity, and view your friends' feeds.



The content and order of the cards update automatically at a specified interval. To manually update cards, swipe downwards on the screen.

Editing cards list

- To pin a card to the top of the Bixby Home screen, tap  → **Pin to top**. To unpin a card, tap  → **Unpin**.
- To stop displaying a card on the list, drag the card to the right and tap **Don't show again**.
- To hide a card from the list, drag the card to the right and tap **Hide for now**.

Selecting apps to show as cards

Add or delete apps to show as cards on the Bixby Home screen.

On the Bixby Home screen, tap  → **Cards** and tap the switches next to items to add or delete them.



If an app is not installed on the device, you must install it to use it. On the Bixby Home screen, tap  → **Cards** and then download an app.

Customising the Bixby Home settings

On the Bixby Home screen, tap  → **Settings**.

- **Customisation Service:** Set to use Bixby's interactive and customised services to enhance your experience.
- **Bixby Home content providers:** Read and agree to or withdraw your agreement from the terms and conditions and privacy policies of each content provider.
- **About Bixby Home:** View the Bixby Home version and legal information.

Reminder

Create reminders to schedule to-do items or to view content later. You will receive notifications at the preset time or location for each reminder.



- To receive more accurate notifications, connect to a Wi-Fi or mobile network.
- To fully use this feature, you must register and sign in to your Samsung account.
- To use location reminders, the GPS feature must be activated.

Starting Reminder

You can start Reminder from Bixby Home.

1 On the Home screen, swipe to the right.
The Bixby Home screen will appear.

2 Tap **Get started** on the **Reminder** card.

The Reminder screen will appear and the **Reminder** app icon (🔔) will be added to the Apps screen.

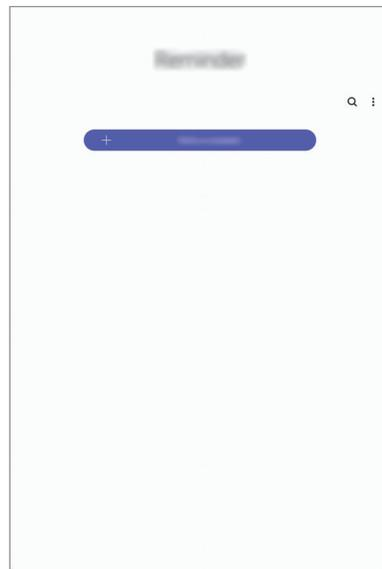
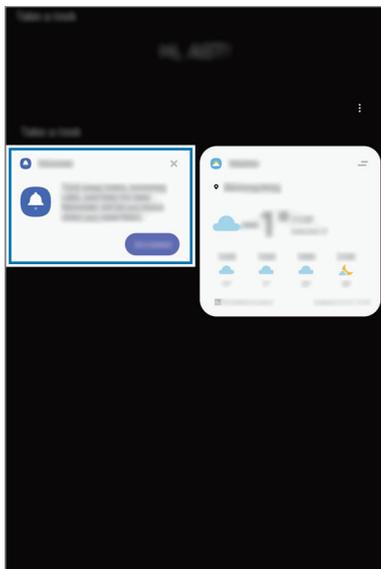

Creating reminders

Create reminders with various methods. Reminder will alert you if you create a reminder with a specified time or location setting. You can also save various content, such as a single memo or webpage address, and view it later.

For example, create a reminder to alert you to 'Water the flowers when I get home.'

- 1 Launch the **Reminder** app.
- 2 Tap **Write a reminder** or **+** and enter 'Water the flowers.'
- 3 Tap **Place** → **Set conditions** → **Pick a place** and set the location to home.
- 4 Tap **When I arrive at** → **Done**.

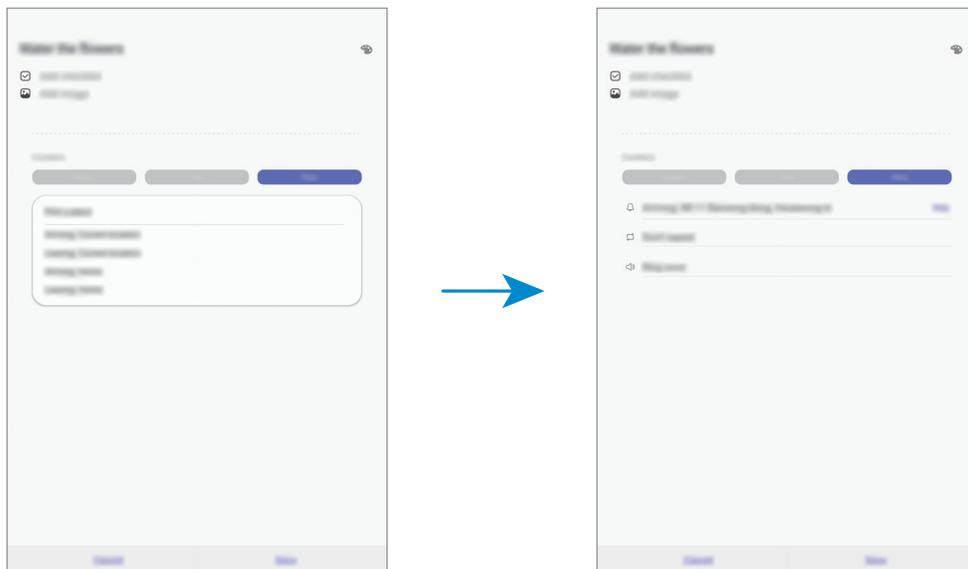

- 5 Tap **Save** to save the reminder.

When you arrive at home, the 'Water the flowers' notification will appear.

Checking reminder notifications

At the preset time or location, a notification pop-up window will appear. Tap **Complete** or **Snooze**.

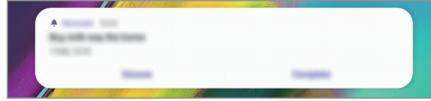

Viewing the reminders list

Launch the **Reminder** app to view your reminders list. To view reminder details, select a reminder.

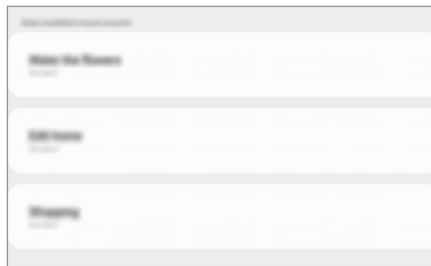

Editing reminder details

Add or edit reminder details, such as frequency, date and time, or location.

- 1 On the reminders list, select a reminder to edit and tap **Edit**.
- 2 Edit the conditions and tap **Save**.

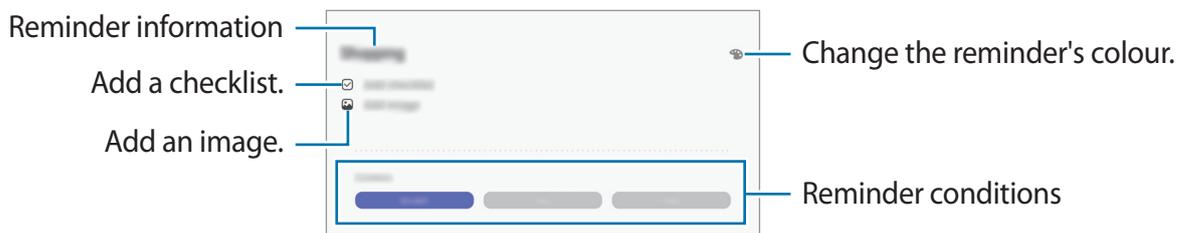

Completing reminders

Mark reminders that you do not need to be reminded of as complete.

On the reminders list, select a reminder and tap **Complete**. Alternatively, drag the reminder to the left.

Restoring reminders

Restore reminders that have been completed.

1 On the reminders list, tap  → **Completed** → **Edit**.

2 Tick items to restore and tap **Restore**.

Reminders will be added to the reminders list and you will be reminded at the preset times.

Deleting reminders

To delete a reminder, drag the reminder to the right. To delete multiple reminders, tap and hold a reminder, tick reminders to delete, and then tap **Delete**.

SmartThings

Introduction

Connect to nearby devices, such as Bluetooth headsets or other smartphones, easily and quickly. You can also control and manage TVs, home appliances, and Internet of Things (IoT) products with your tablet.

You can add and manage devices by location and room. For example, add 'home' as a location and manage devices by room, such as the living room and bedroom.

- **Connecting with nearby devices:** Connect with nearby devices, such as Bluetooth headsets or wearable devices, easily and quickly.
- **Registering and controlling home appliances, TVs, and IoT products:** Register smart refrigerators, washers, air conditioners, air purifiers, TVs, and Internet of Things (IoT) products on your tablet, and view their status or control them from your tablet's screen.
- **Receiving notification:** Receive notifications from connected devices on your tablet. For example, when the laundry is finished, you can receive a notification on your tablet.



- To use SmartThings, your tablet and other devices must be connected to a Wi-Fi or mobile network.
- To fully use SmartThings, you must sign in to your Samsung account.
- The devices you can connect may vary depending on the region or service provider. To see the list of connectable devices, launch the **SmartThings** app and tap  → **How to use** → **Supported devices**.
- Available features may differ depending on the connected device.
- Connected devices' own errors or defects are not covered by the Samsung warranty. When errors or defects occur on the connected devices, contact the device's manufacturer.

Connecting to nearby devices

Connect to nearby devices, such as Bluetooth headsets, easily and quickly.



Connection methods may vary depending on the type of connected devices or the shared content.

- 1 Launch the **SmartThings** app.
- 2 Tap **+ → Add device**.
- 3 Select a device from the list and connect to it by following the on-screen instructions.

Using home appliances, TVs, and IoT products

View the status of your smart appliances, TVs, and IoT products from your tablet's screen. You can group devices by location and add rules to control the devices easily and conveniently.

Connecting devices

- 1 Launch the **SmartThings** app.
- 2 Tap **+ → Add device**.
- 3 Tap **Auto detect** and select a device from the list.
If there is no device on the list, tap  next to **Samsung** and select a device type. Or, tap  and enter the device or model name.
- 4 Follow the on-screen instructions to register devices.

Viewing and controlling connected devices

You can view and control the devices. For example, you can check the ingredients in your refrigerator or adjust the TV volume.

1 Launch the **SmartThings** app.

The list of connected devices will appear.

2 View the status of devices on the list.

To control the devices, select a device. When the device controller supplied with the selected device is downloaded, you can control the device.

Adding devices and scenes by locations

Add devices by locations, view the list of devices in a same location, and control them. You can also add a scene to a location to control multiple devices at the same time.

Adding locations

1 Launch the **SmartThings** app and tap  →  → **Add new location**.

2 Enter the location name.

- To set a location, tap **Geolocation** to select a location on the map and tap **Done**.
- To add rooms to the location, tap **Rooms**, tick rooms you want to add, and then tap **Done**.

3 Tap **Done**.

Your location will be added.

To add devices to the location, tap  → **Add device** and follow the on-screen instructions to register devices.

Adding scenes

Add a scene and register devices to it to control multiple devices at the same time with a single tap of a button.

- 1 Launch the **SmartThings** app.
- 2 Tap  →  and select a location.
- 3 Tap  → **Add scene**.
- 4 Enter the scene name.
- 5 Tap  under **Add actions** to add actions to perform.
- 6 Tap **Save**.

Adding automations

You can also set an automation to operate devices automatically depending on the preset time, the status of devices, and more.

For example, add an automation to turn on the audio automatically every day at 7:00 AM.

- 1 Launch the **SmartThings** app.
- 2 Tap  →  and select a location.
- 3 Tap  → **Add automation**.
- 4 Tap  under **If** and set the activation conditions for the automation.
- 5 Tap  under **Then** and set actions to perform.
- 6 Tap **Save**.

Receiving notifications

You can receive notifications from connected devices on your tablet. For example, when the laundry is finished, you can receive a notification on your tablet.

To set devices to receive notifications, launch the **SmartThings** app, tap  →  → **Notifications**, and then tap the switches next to the devices you want.

Sharing content

Share content by using various sharing options. The following actions are an example of sharing images.



You may incur additional charges when sharing files via the mobile network.
(SM-T725, SM-T727)

- 1 Launch the **Gallery** app and select an image.
- 2 Tap  and select a sharing method, such as email.

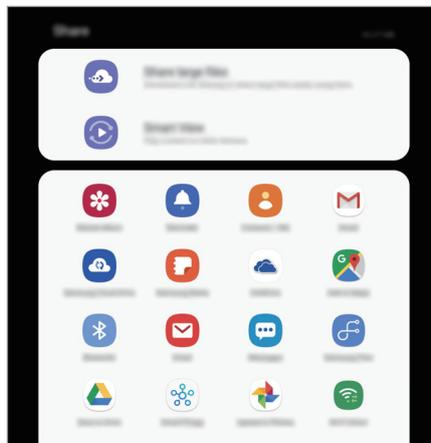

When you have a communication or sharing history, the people you contacted will appear on the sharing options panel. To directly share content with them via the corresponding app, select a person's icon. If the feature is not activated, launch the **Settings** app, tap **Advanced features**, and then tap the **Direct share** switch to activate it.

Using additional features

- **Share large files:** Share large files. Upload files to the Samsung storage server and share them with others via a Web link or a code. To use this feature, your phone number must be verified. (SM-T725, SM-T727)



To use this feature, launch the **Settings** app, tap **Connections**, and then tap the **Call & Message Continuity** switch to activate it. You must register and sign in to the same Samsung account on your device and the other device. (SM-T720)

- **Smart View:** Share content with nearby devices via Wi-Fi Direct or Bluetooth, or with SmartThings supported devices. You can also view your device's displayed content on a large screen by connecting your device to a screen mirroring-enabled TV or monitor.

When the image is sent to the recipients' devices, a notification will appear on their devices. Tap the notification to view or download the image.

Daily Board

Introduction

Daily Board lets you use your tablet as a picture frame when it is charging or connected to a dock. You can enjoy a slideshow with your favourite images and view the information such as the time or the weather.



- You must use a pogo charging dock if you want to use this feature by connecting your tablet to a dock.
- The pogo charging dock is sold separately.

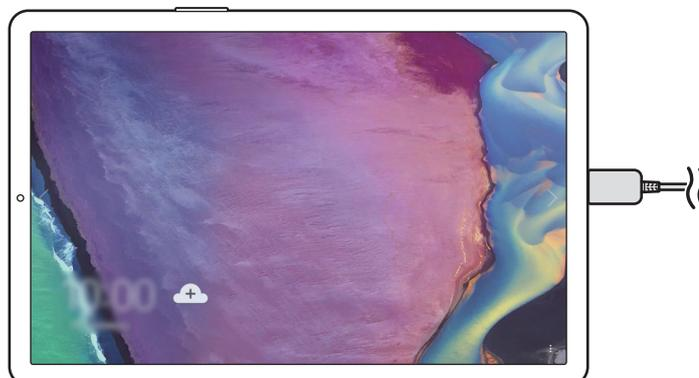

Launching Daily Board

Launching Daily Board while charging

- 1 When the device is charging, drag the status bar downwards to open the notification panel.
- 2 Tap **Tap here to start Daily Board.** to start Daily Board.
If you are using this feature for the first time, read and agree to the terms and conditions, and then tap **Agree.**

Launching Daily Board using a dock

- 1 Connect the charger to the charging dock.
- 2 Slide the device into the charging dock to meet the device's connectors and the dock's charging terminals.
- 3 When the device is connected to the charging dock, Daily Board will launch automatically.
If you are using this feature for the first time, read and agree to the terms and conditions, and then tap **Agree.**

 If Daily Board does not start automatically, launch the **Settings** app, tap **Advanced features** → **Daily Board**, and then tap the **Auto start** switch to activate it.

Adding images

You can add your favourite images to display.

- 1 Launch the **Settings** app, tap **Advanced features** → **Daily Board**.
- 2 Tap **Slideshow** → **Select albums** and select an album.
The selected images will be displayed when the slideshow starts.

Closing Daily Board

To close Daily Board, tap the Back button.

Deactivating Daily Board

You can set the device to prevent Daily Board from launching even when a charger or a dock is connected.

Launch the **Settings** app, tap **Advanced features**, and then tap the **Daily Board** switch to deactivate it.

Samsung DeX

Introduction

Samsung DeX is a service that allows you to use your tablet like a computer from tablet screen or an external display, such as a TV or monitor. While using Samsung DeX on external display, you can simultaneously use your tablet.

You can connect your tablet to the Keyboard Cover or external display using a DeX Cable. The following content is about how to use the Keyboard Cover and DeX Cable.



- All accessories are sold separately.
- Use only official Samsung DeX supported accessories that are provided by Samsung. Performance problems and malfunctions caused by using accessories that are not officially supported are not covered by the warranty.



On tablet screen

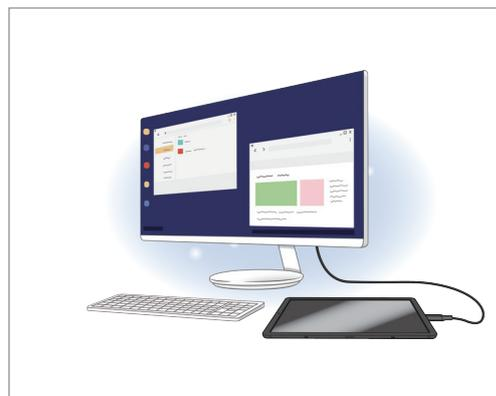

On external display

Starting Samsung DeX

You can use Samsung DeX in two ways, on tablet screen and external display.

Starting Samsung DeX on tablet screen

Use your tablet like a computer by connecting the Keyboard Cover.

To switch to Samsung DeX directly when connecting the Keyboard Cover, launch the **Settings** app, tap **Advanced features** → **Samsung DeX**, and then tap the **Auto start when Book Cover Keyboard is connected** switch to activate it.

- 1 Position the tablet's rear camera to insert it into the rear camera hole and put the tablet in the stand.

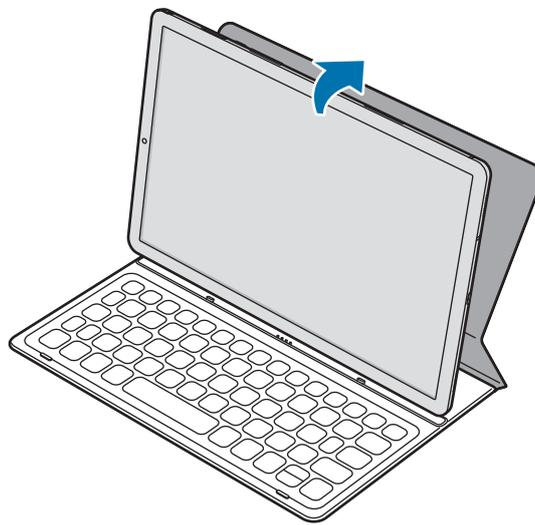

- 2 Insert the tablet into the connection hole to meet the tablet's connectors and the dock ports.

Your tablet's screen will change into Samsung DeX.

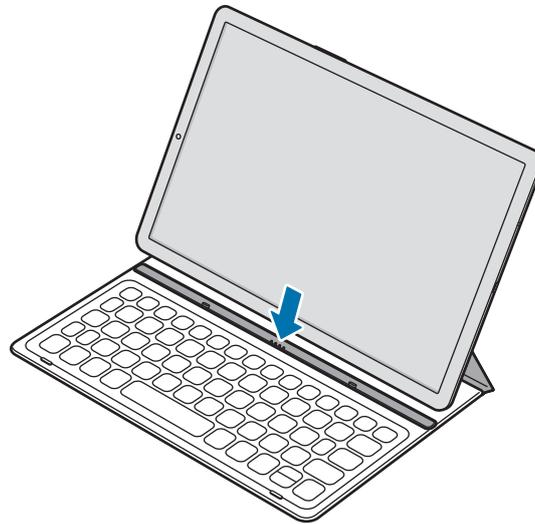

You can also launch Samsung DeX from quick settings without Keyboard Cover. Swipe downwards on the notification panel and tap **Samsung DeX**.

Closing Samsung DeX on tablet screen

To close Samsung DeX on tablet screen, on the status bar, tap  → . Alternatively, launch the **Settings** app, tap **Samsung DeX** switch to deactivate it. You can also close Samsung DeX from Samsung DeX panel. Tap **DeX** at the bottom of the left corner and tap **Exit DeX**.

Starting Samsung DeX on external display

Connect your tablet to an external display and use tablet's features on a large screen. Without changing your tablet's screen, the Samsung DeX screen will appear on the connected TV or monitor.

To switch to Samsung DeX directly when connecting the DeX Cable, launch the **Settings** app, tap **Advanced features** → **Samsung DeX**, and then tap the **Auto start when HDMI is connected** switch to activate it.

- 1 Plug a tablet connector into the multipurpose jack on the tablet.
- 2 Connect the HDMI connector to a TV or monitor's HDMI port.
Samsung DeX screen will appear on the connected screen.

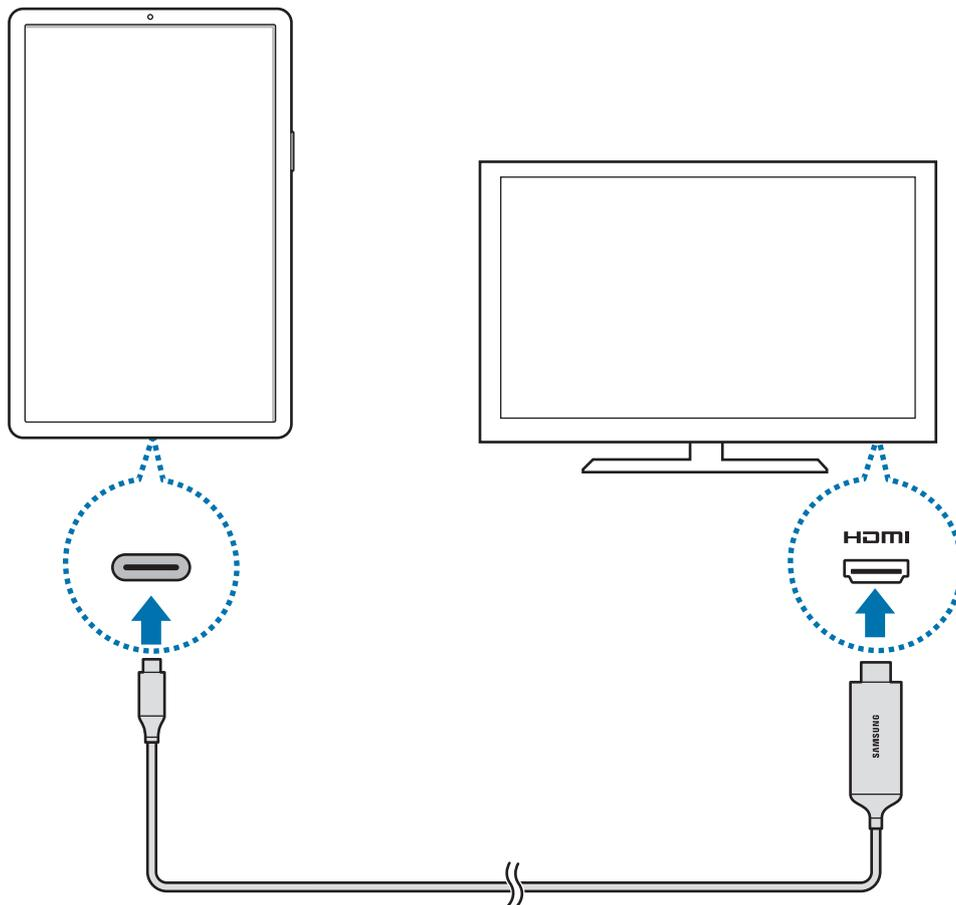

Closing Samsung DeX on external display

To close Samsung DeX on external display, disconnect your tablet from the DeX Cable or tap  →  on the status bar. Alternatively, launch the **Settings** app and tap **Samsung DeX** switch to deactivate it. You can also close Samsung DeX from Samsung DeX panel. Tap **DeX** at the bottom of the left corner and tap **Exit DeX**.

Using Samsung DeX

Use your tablet's features in an interface environment similar to a computer. You can multitask by running multiple apps simultaneously. You can also check your tablet's notifications and status.



- When starting or ending Samsung DeX, running apps may be closed.
- Some apps or features may not be available when using Samsung DeX.
- To adjust the screen settings, use the connected TV or monitor's display settings.
- **Favourite apps:** Add frequently used apps to the Home screen and launch them quickly.
- **Samsung DeX panel:** Provide frequently used functions and launch them such as **Exit DeX**, **Lock DeX**, or **DeX Labs** quickly.
- **Apps button:** View and run your tablet's apps. To see apps that are optimised for Samsung DeX, tap **check out apps for Samsung DeX banner**.

- **Taskbar:** View the apps that are currently running.
- **Status bar:** View your tablet's notifications and status. Status icons may appear differently depending on your tablet's status. When you click , the quick setting buttons will appear. You can activate or deactivate certain tablet features using the quick setting buttons.
- **Quick access toolbar:** Use quick tools, such as screen keyboard, volume control, or search.

Using the external display and tablet simultaneously

While using Samsung DeX, you can use separate apps on the external display and your tablet simultaneously.

For example, while watching a video on the connected TV or monitor, you can create a note on your tablet.

On the connected TV or monitor, launch an app to run on the Samsung DeX screen. Then, launch another app on your tablet.

Locking the Samsung DeX screen

If you want to lock the external display and your tablet's screen while using Samsung DeX, tap **DeX** at the bottom of the left corner, and then tap **Lock DeX**.



While using Samsung DeX, you cannot lock the external display and your tablet's screen by pressing the Power key.

Enjoying games vividly on a large screen

Play your tablet's games on a large screen. On the connected TV or monitor, launch the **Game Launcher** app.

Controlling the Samsung DeX screen

Controlling with an external keyboard and mouse

You can use a wireless keyboard/mouse or a Bluetooth keyboard/mouse. You can also use USB keyboard or mouse by connecting them to the Multiport Adapter's USB port. Refer to the respective device's manual for more information.

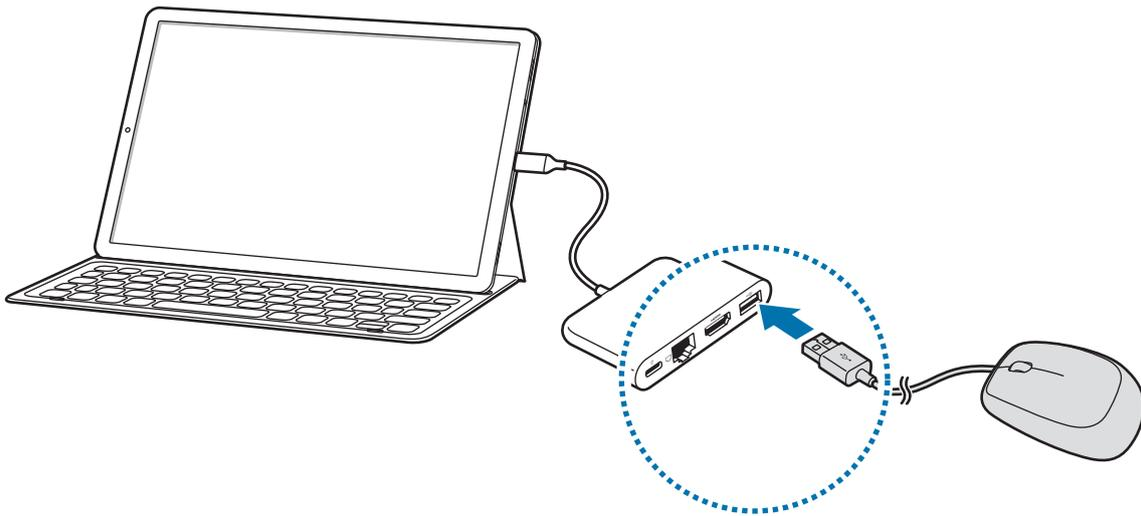

- You can set the mouse pointer to flow from the external display to the tablet's screen. Launch the **Settings** app, select **Samsung DeX** → **Mouse/trackpad**, and then select the **Flow pointer to tablet screen** switch to activate it.
- You can also use the external keyboard on the tablet's screen.

Using your tablet as a touchpad

You can use your tablet as a touchpad and operate it with your fingers.

On your tablet, drag downwards from the top of the screen to open the notification panel and tap **Use your tablet as a touchpad**.



- You can use the touchpad only when using Samsung DeX on external display.
- If your tablet's screen turns off, press the Power key or double-tap anywhere on the screen to turn on the screen.



Orienting the touchpad

When you are using your tablet as a touchpad, you can use it in either the horizontal or vertical alignment.

To rotate the touchpad, rotate the tablet or double-tap .

Using your tablet while using the touchpad

You can use apps on your tablet even while it is being used as a touchpad.

Drag upwards from the bottom of the screen to show the navigation bar, tap the Home button to move to the Home screen, and then select apps you want to use.

Using the screen keyboard

When you enter text to send messages, create notes, or perform other tasks, a screen keyboard will appear automatically on your tablet's screen without connecting an external keyboard.



To send a text message, launch the **Settings** app, tap **Connections**, and then tap the **Call & Message Continuity** switch to activate it. You must register and sign in to the same Samsung account on your device and the other device. (SM-T720)

If the keyboard does not appear, select  on the quick access toolbar.

Ending Samsung DeX

When you use Samsung DeX on tablet screen, on the status bar, tap  → .

When you use Samsung DeX from the connected TV or monitor, disconnect your tablet from the DeX Cable or tap  →  on the status bar. You can also close Samsung DeX from Samsung DeX panel. Tap **DeX** at the bottom of the left corner and tap **Exit DeX**.

Google apps

Google provides entertainment, social network, and business apps. You may require a Google account to access some apps.

To view more app information, access each app's help menu.



Some apps may not be available or may be labelled differently depending on the region or service provider.

Chrome

Search for information and browse webpages.

Gmail

Send or receive emails via the Google Mail service.

Maps

Find your location on the map, search the world map, and view location information for various places around you.

Play Music

Discover, listen to, and share music on your device. You can upload music collections stored on your device to the cloud and access them later.

Play Movies & TV

Purchase or rent videos, such as movies and TV programmes, from **Play Store**.

Drive

Store your content on the cloud, access it from anywhere, and share it with others.

YouTube

Watch or create videos and share them with others.

Photos

Search for, manage, and edit all your photos and videos from various sources in one place.

Google

Search quickly for items on the Internet or your device.

Duo

Make a simple video call.

Settings

Introduction

Customise device settings. You can make your device more personalised by configuring various setting options.

Launch the **Settings** app.

To search for settings by entering keywords, tap **Q**.

Connections

Options

Change settings for various connections, such as the Wi-Fi feature and Bluetooth.

On the Settings screen, tap **Connections**.

- **Wi-Fi:** Activate the Wi-Fi feature to connect to a Wi-Fi network and access the Internet or other network devices. Refer to [Wi-Fi](#) for more information.
- **Bluetooth:** Use Bluetooth to exchange data or media files with other Bluetooth-enabled devices. Refer to [Bluetooth](#) for more information.
- **Tablet visibility:** Allow other devices to find your device to share content with you. When this feature is activated, your device will be visible to other devices when they search for available devices using their Transfer files to device option.
- **Flight mode:** Set the device to disable all wireless functions on your device. You can use only non-network services.



Follow the regulations provided by the airline and the instructions of aircraft personnel. In cases where it is allowed to use the device, always use it in flight mode.

- **Mobile networks:** Configure your mobile network settings. (SM-T725, SM-T727)
- **Data usage**
 - ▶ **SM-T725, SM-T727:** Keep track of your data usage amount and customise the settings for the limitation. Set the device to automatically disable the mobile data connection when the amount of mobile data you have used reaches your specified limit.
You can also activate the data saver feature to prevent some apps running in the background from sending or receiving data. Refer to [Data saver \(SM-T725, SM-T727\)](#) for more information.
 - ▶ **SM-T720:** Keep track of your data usage amount.
- **Mobile Hotspot and Tethering:** Use the device as a mobile hotspot to share the device's mobile data connection with other devices when the network connection is not available. Connections can be made via Wi-Fi, USB, or Bluetooth. Refer to [Mobile Hotspot and Tethering \(SM-T725, SM-T727\)](#) for more information. (SM-T725, SM-T727)
- **Call & Message Continuity:** Use your device's calling and messaging features on other devices signed in to your Samsung account. (SM-T720)
 -  • You must register and sign in to the same Samsung account on your device and the other device.
 - This feature may not be available depending on the region or service provider.
- **More connection settings:** Customise settings to control other features. Refer to [More connection settings](#) for more information.

Wi-Fi

Activate the Wi-Fi feature to connect to a Wi-Fi network and access the Internet or other network devices.

Connecting to a Wi-Fi network

1 On the Settings screen, tap **Connections** → **Wi-Fi**, and then tap the switch to activate it.

2 Select a network from the Wi-Fi networks list.

Networks that require a password appear with a lock icon. Enter the password and tap **Connect**.



- Once the device connects to a Wi-Fi network, the device will reconnect to that network each time it is available without requiring a password. To prevent the device connecting to the network automatically, select it from the list of networks and tap **Forget**.
- If you cannot connect to a Wi-Fi network properly, restart your device's Wi-Fi feature or the wireless router.

Wi-Fi Direct

Wi-Fi Direct connects devices directly via a Wi-Fi network without requiring an access point.

1 On the Settings screen, tap **Connections** → **Wi-Fi**, and then tap the switch to activate it.

2 Tap **Wi-Fi Direct**.

The detected devices are listed.

If the device you want to connect to is not in the list, request that the device turns on its Wi-Fi Direct feature.

3 Select a device to connect to.

The devices will be connected when the other device accepts the Wi-Fi Direct connection request.

Sending and receiving data

You can share data, such as contacts or media files, with other devices. The following actions are an example of sending an image to another device.

- 1 Launch the **Gallery** app and select an image.
- 2 Tap  → **Wi-Fi Direct** and select a device to transfer the image to.
- 3 Accept the Wi-Fi Direct connection request on the other device.
If the devices are already connected, the image will be sent to the other device without the connection request procedure.

Ending the device connection

- 1 On the Settings screen, tap **Connections** → **Wi-Fi**.
- 2 Tap **Wi-Fi Direct**.
The device displays the connected devices in the list.
- 3 Tap the device name to disconnect the devices.

Bluetooth

Use Bluetooth to exchange data or media files with other Bluetooth-enabled devices.



- Samsung is not responsible for the loss, interception, or misuse of data sent or received via Bluetooth.
- Always ensure that you share and receive data with devices that are trusted and properly secured. If there are obstacles between the devices, the operating distance may be reduced.
- Some devices, especially those that are not tested or approved by the Bluetooth SIG, may be incompatible with your device.
- Do not use the Bluetooth feature for illegal purposes (for example, pirating copies of files or illegally tapping communications for commercial purposes). Samsung is not responsible for the repercussion of illegal use of the Bluetooth feature.

Pairing with other Bluetooth devices

- 1 On the Settings screen, tap **Connections** → **Bluetooth**, and then tap the switch to activate it.

The detected devices will be listed.

- 2 Select a device to pair with.

If the device you want to pair with is not on the list, set the device to enter Bluetooth pairing mode. Refer to the other device's user manuals.



Your device is visible to other devices while the Bluetooth settings screen is open.

- 3 Accept the Bluetooth connection request on your device to confirm.

The devices will be connected when the other device accepts the Bluetooth connection request.

Sending and receiving data

Many apps support data transfer via Bluetooth. You can share data, such as contacts or media files, with other Bluetooth devices. The following actions are an example of sending an image to another device.

- 1 Launch the **Gallery** app and select an image.
- 2 Tap  → **Bluetooth**, and then select a device to transfer the image to.
If your device has paired with the device before, tap the device name without confirming the auto-generated passkey.
If the device you want to pair with is not in the list, request that the device turns on its visibility option.
- 3 Accept the Bluetooth connection request on the other device.

Unpairing Bluetooth devices

- 1 On the Settings screen, tap **Connections** → **Bluetooth**.
The device displays the paired devices in the list.
- 2 Tap  next to the device name to unpair.
- 3 Tap **Unpair**.

Data saver (SM-T725, SM-T727)

Reduce your data usage by preventing some apps running in the background from sending or receiving data.

On the Settings screen, tap **Connections** → **Data usage** → **Data saver** and tap the switch to activate it.

When the data saver feature is activated, the  icon will appear on the status bar.

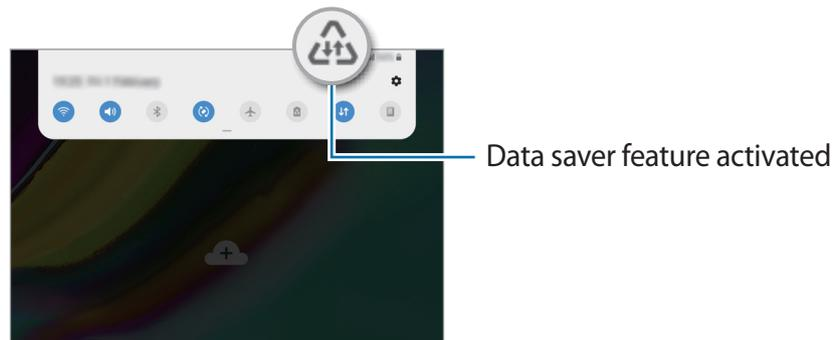

To select apps to use data without restriction, tap **Allow app while Data saver on** and select apps.

Mobile Hotspot and Tethering (SM-T725, SM-T727)

Use the device as a mobile hotspot to share the device's mobile data connection with other devices when the network connection is not available. Connections can be made via Wi-Fi, USB, or Bluetooth.

On the Settings screen, tap **Connections** → **Mobile Hotspot and Tethering**.



You may incur additional charges when using this feature.

- **Mobile Hotspot:** Use the mobile hotspot to share the device's mobile data connection with computers or other devices.
- **Bluetooth tethering:** Use Bluetooth tethering to share the device's mobile data connection with computers or other devices via Bluetooth.
- **USB tethering:** Use USB tethering to share the device's mobile data connection with a computer via USB. When connected to a computer, the device is used as a wireless modem for the computer.

Using the mobile hotspot

Use your device as a mobile hotspot to share your device's mobile data connection with other devices.

1 On the Settings screen, tap **Connections** → **Mobile Hotspot and Tethering** → **Mobile Hotspot**.

2 Tap the switch to activate it.

The  icon appears on the status bar. Other devices can find your device in the Wi-Fi networks list.

To set a password for the mobile hotspot, tap  → **Configure Mobile Hotspot** and select the level of security. Then, enter a password and tap **Save**.

3 On the other device's screen, search for and select your device from the Wi-Fi networks list.



- If the mobile hotspot is not found, on your device, tap  → **Configure Mobile Hotspot**, tick **Show advanced options**, and then deselect **Hide my device** and **Use 5 GHz band when available**.

- If the other device cannot connect to the mobile hotspot, on your device, tap  → **Allowed devices** and tap the **Allowed devices only** switch to deactivate it.

4 On the connected device, use the device's mobile data connection to access the Internet.

More connection settings

Customise settings to control other connection features.

On the Settings screen, tap **Connections** → **More connection settings**.

- **Nearby device scanning:** Set the device to scan for nearby devices to connect to.
- **Printing:** Configure settings for printer plug-ins installed on the device. You can search for available printers or add one manually to print files. Refer to [Printing](#) for more information.
- **VPN:** Set up virtual networks (VPNs) on your device to connect to a school or company's private network.
- **Private DNS:** Use the reliable domain name system (DNS) for a school or company's internal private network instead of using the external hosting network. The DNS will be searched for and connected to automatically, or you can search for the DNS and connect to it manually.
- **Ethernet:** When you connect an Ethernet adaptor, you can use a wired network and configure network settings.

Printing

Configure settings for printer plug-ins installed on the device. You can connect the device to a printer via Wi-Fi or Wi-Fi Direct, and print images or documents.



Some printers may not be compatible with the device.

Adding printer plug-ins

Add printer plug-ins for printers you want to connect the device to.

- 1 On the Settings screen, tap **Connections** → **More connection settings** → **Printing** → **Download plugin**.

2 Search for a printer plug-in in **Play Store**.

3 Select a printer plug-in and install it.

4 Select the installed printer plug-in.

The device will automatically search for printers that are connected to the same Wi-Fi network as your device.

5 Select a printer to add.



To add printers manually, tap  → **Add printer**.

Printing content

While viewing content, such as images or documents, access the options list, tap **Print** → ▼ → **All printers...**, and then select a printer.



Printing methods may vary depending on the content type.

Sounds and vibration / Sound

Options

Change settings for various sounds on the device.

On the Settings screen, tap **Sounds and vibration / Sound**.

- **Sound mode:** Set the device to use sound mode, vibration mode, or silent mode.
- **Vibrate while ringing:** Set the device to vibrate and play a ringtone for incoming calls. (SM-T725)
- **Ringtone:** Change the call ringtone. (SM-T720, SM-T725)



This feature may not be available depending on the region or service provider.

- **Vibration pattern:** Select a vibration pattern. (SM-T725)
- **Notification sounds:** Change the notification sound.

- **Volume**
 - ▶ **SM-T725:** Adjust the volume level for call ringtones, music and videos, system sounds, and notifications.
 - ▶ **SM-T720, SM-T727:** Adjust the volume level for music and videos, system sounds, and notifications.
- **Use Volume keys for media:** Set the device to adjust the media volume level when you press the Volume key.
- **System sounds:** Set the device to sound for actions, such as turning the screen on or off or controlling the touchscreen.
- **Advanced sound settings:** Optimise the settings for when media is being played. Refer to [Dolby Atmos \(surround sound\)](#) or [Separate app sound](#) for more information.

Dolby Atmos (surround sound)

Select a surround sound mode optimised for various types of audio, such as movies, music, and voice. With Dolby Atmos, you can experience moving audio sounds that flows all around you.

On the Settings screen, tap **Sounds and vibration / Sound** → **Advanced sound settings** → **Sound quality and effects** → **Dolby Atmos**, tap the switch to activate it, and then select a mode.

Separate app sound

Set the device to play media sound from a specific app on the connected Bluetooth speaker or headset separate from the sound of other apps.

For example, you can listen to the Navigation app through your device's speaker while listening to playback from the Music app through the vehicle's Bluetooth speaker.

- 1 On the Settings screen, tap **Sounds and vibration / Sound** → **Advanced sound settings** → **Separate app sound** and tap the switch to activate it.
- 2 Select an app to play media sounds separately and tap the Back button.
- 3 Select a device for playing the selected app's media sound.

Notifications

Options

Change the notification settings.

On the Settings screen, tap **Notifications**.

- **App icon badges:** Change the settings for app icon badges. Refer to [App icon badges](#) for more information.
- **Do not disturb:** Set the device to mute notification sounds and media, except for allowed exceptions.
- **Status bar:** Set the device to display only three recent notifications and whether to show the remaining battery level in percentage on the status bar.
- **Recently sent:** View the apps that received recent notifications and change the notification settings. To customise notification settings for more apps, tap **See all** → ▼ → **All** and select an app from the app list.

App icon badges

Change the settings for app icon badges.

On the Settings screen, tap **Notifications** → **App icon badges**.

To display icon badges, tap the switch to activate it. To change the badge style, select an option under **Badge style**.

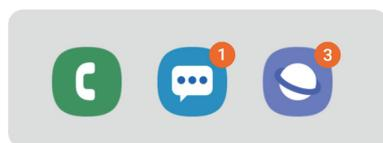

With number

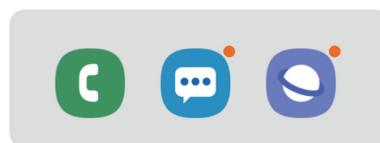

Without number

Display

Options

Change the display and the Home screen settings.

On the Settings screen, tap **Display**.

- **Brightness:** Adjust the brightness of the display.
- **Adaptive brightness:** Set the device to keep track of your brightness adjustments and apply them automatically in similar lighting conditions.
- **Blue light filter:** Activate the blue light filter and change the filter settings. Refer to [Blue light filter](#) for more information.
- **Night mode:** Reduce eye strain by applying the dark theme when using the device at night or in a dark place.
 -  • Turn on the GPS feature to set the device to activate night mode at night and turn it off in the morning based on your current location.
 - The dark theme may not be applied in some apps.
- **Screen mode:** Change the screen mode to adjust the display's colour and contrast. Refer to [Changing the screen mode or adjusting the display colour](#) for more information.
- **Font size and style:** Change the font size and style.
- **Screen zoom:** Change the screen zoom setting.
- **Screen timeout:** Set the length of time the device waits before turning off the display's backlight.
- **Home screen:** Change the Home screen settings.
- **Navigation bar:** Change the navigation bar settings. Refer to [Navigation bar \(soft buttons\)](#) for more information.
- **Screensaver:** Set the device to launch a screensaver when the device is charging or connected to a dock. Refer to [Screensaver](#) for more information.

Blue light filter

Reduce eye strain by limiting the amount of blue light emitted by the screen.



While you are watching HDR videos from HDR-exclusive video services, the blue light filter may not be applied.

- 1 On the Settings screen, tap **Display** → **Blue light filter**, and then tap the **Turn on now** switch to activate it.
- 2 Drag the adjustment bar to adjust the filter's opacity.
- 3 To set the schedule to apply the blue light filter to the screen, tap the **Turn on as scheduled** switch to activate it and select an option.
 - **Sunset to sunrise:** Set the device to apply the blue light filter at night and turn it off in the morning based on your current location.
 - **Custom schedule:** Set a specific time to apply the blue light filter.

Changing the screen mode or adjusting the display colour

Select a screen mode suitable for viewing movies or images, or adjust the display colour to your preference. If you select the **Adaptive display** mode, you can adjust the display colour balance by colour value.

Changing the screen mode

On the Settings screen, tap **Display** → **Screen mode** and select a mode you want.

- **Adaptive display:** This optimises the colour range, saturation, and sharpness of your display. You can also adjust the display colour balance by colour value.
- **AMOLED cinema:** This is suitable for watching videos.
- **AMOLED photo:** This is suitable for viewing images.
- **Basic:** This is set as default and is suitable for general use.



- You can adjust the display colour only in **Adaptive display** mode.
- **Adaptive display** mode may not be compatible with third-party apps.
- You cannot change the screen mode while applying the blue light filter.

Optimising the full screen colour balance

Optimise the display colour by adjusting the colour tones to your preference.

When you drag the colour adjustment bar towards **Cool**, the blue colour tone will increase. When you drag the bar towards **Warm**, the red colour tone will increase.

- 1 On the Settings screen, tap **Display** → **Screen mode** → **Adaptive display**.
- 2 Adjust the colour adjustment bar under **White balance**.
The colour balance of the screen will be optimised.



Adjusting the screen tone by colour value

Increase or lower certain colour tones by adjusting the value individually.

- 1 On the Settings screen, tap **Display** → **Screen mode** → **Adaptive display**.
- 2 Tap **Advanced settings**.
- 3 Adjust the colour bar to your preference.
The screen tone screen will be adjusted.

Screensaver

You can set to display images as a screensaver when the screen turns off automatically. The screensaver will be displayed when the device is charging or connected to a dock.

1 On the Settings screen, tap **Display** → **Screensaver** and tap the switch to activate it.

2 Select an option.

If you select **Photo Frame**, a slideshow with selected images will start. If you select **Photo Table** or **Photos**, selected images will appear as small cards and overlap.

3 Tap  to select albums for displaying images.

4 When you are finished, tap the Back button.

To preview the selected option, tap **Preview**.



When you tap the screen while your screensaver is displayed, the screen will turn on.

Wallpaper

Change the wallpaper settings for the Home screen and the locked screen.

On the Settings screen, tap **Wallpaper**.

Lock screen

Options

Change the settings for the locked screen.

On the Settings screen, tap **Lock screen**.



The available options may vary depending on the screen lock method selected.

- **Screen lock type:** Change the screen lock method.
- **Smart Lock:** Set the device to unlock itself when trusted locations or devices are detected. Refer to [Smart Lock](#) for more information.
- **Secure lock settings:** Change screen lock settings for the selected lock method.
- **Clock style:** Change the type and colour of the clock on the locked screen.
- **Roaming clock:** Change the clock to show both the local and home time zones on the locked screen when roaming. (SM-T725, SM-T727)
- **FaceWidgets:** Change the settings of the items displayed on the locked screen.
- **Contact information:** Set the device to show contact information, such as your email address, on the locked screen.
- **Notifications:** Set how to show notifications on the locked screen.
- **App shortcuts:** Select apps to display shortcuts to them on the locked screen.
- **About Lock screen:** View the Locked screen version and legal information.

Smart Lock

You can set the device to unlock itself and remain unlocked when trusted locations or devices are detected.

For example, if you have set your home as a trusted location, when you get home your device will detect the location and automatically unlock itself.



- This feature will be available to use after you set a screen lock method.
- If you do not use your device for four hours or when you turn on the device, you must unlock the screen using the pattern, PIN, or password you set.

- 1 On the Settings screen, tap **Lock screen** → **Smart Lock**.
- 2 Unlock the screen using the preset screen lock method.
- 3 Select an option and follow the on-screen instructions to complete the setting.

Biometrics and security

Options

Change the settings for securing the device.

On the Settings screen, tap **Biometrics and security**.

- **Face recognition:** Set the device to unlock the screen by recognising your face. Refer to [Face recognition](#) for more information.
- **Fingerprints:** Register your fingerprints to unlock the screen. Refer to [Fingerprint recognition](#) for more information.
- **Biometrics preferences:** Change the settings for biometric data.
- **Google Play Protect:** Set the device to check for harmful apps and behaviour and warn about potential harm and remove them.

- **Find My Mobile:** Activate or deactivate the Find My Mobile feature. Access the Find My Mobile website (findmymobile.samsung.com) to track and control your lost or stolen device.

You can also allow the Google location service to provide more accurate information about the location of your device.

- **Security update:** View the version of your device's software and check for updates.
- **Samsung Pass:** Verify your identity easily and securely via your biometric data. Refer to [Samsung Pass](#) for more information.
- **Install unknown apps:** Set the device to allow the installation of apps from unknown sources.
- **Secure Folder:** Create a secure folder to protect your private content and apps from others. Refer to [Secure Folder](#) for more information.
- **Encrypt SD card:** Set the device to encrypt files on a memory card.



If you reset your device to the factory defaults with this setting enabled, the device will not be able to read your encrypted files. Disable this setting before resetting the device.

- **Other security settings:** Configure additional security settings.
- **Location:** Change settings for location information permissions.
- **App permissions:** View the list of features and apps that have permission to use them. You can also edit the permission settings.
- **Send diagnostic data:** Set the device to automatically send the device's diagnostic and usage information to Samsung.
- **Receiving marketing information:** Set whether to receive Samsung marketing information, such as special offers, membership benefits, and newsletters.

Face recognition

You can set the device to unlock the screen by recognising your face.



- If you use your face as a screen lock method, your face cannot be used to unlock the screen for the first time after turning on the device. To use the device, you must unlock the screen using the pattern, PIN, or password you set when registering the face. Be careful not to forget your pattern, PIN, or password.
- If you change the screen lock method to **Swipe** or **None**, which are not secure, all of your biometric data will be deleted. If you want to use your biometric data in apps or features, you must register your biometric data again.



Precautions for using face recognition

Before using the face recognition to unlock your device, keep the following precautions in mind.

- Your device could be unlocked by someone or something that looks like your image.
- Face recognition is less secure than Pattern, PIN, or Password.

For better face recognition

Consider the following when using face recognition:

- Consider the conditions when registering, such as wearing glasses, hats, masks, beards, or heavy makeup
- Ensure that you are in a well-lit area and that the camera lens is clean when registering
- Ensure your image is not blurry for better match results

Registering your face

For better face registration, register your face indoors and out of direct sunlight.

- 1 On the Settings screen, tap **Biometrics and security** → **Face recognition**.
- 2 Read the on-screen instructions and tap **Continue**.
- 3 Unlock the screen using the preset screen lock method.
If you have not set a screen lock method, create one.
- 4 Select whether you are wearing glasses or not and tap **Continue**.
- 5 Hold the device with the screen facing towards you and look at the screen.



- 6 Position your face inside the frame on the screen.

The camera will scan your face.

When the useful face recognition screen appears, turn on a switch to activate a feature and tap **OK**.



If unlocking the screen with your face is not working properly, tap **Remove face data** to remove your registered face and register your face again.

Deleting the registered face data

You can delete face data that you have registered.

- 1 On the Settings screen, tap **Biometrics and security** → **Face recognition**.
- 2 Unlock the screen using the preset screen lock method.
- 3 Tap **Remove face data** → **Remove**.

Once the registered face is deleted, all the related features will also be deactivated.

Unlocking the screen with your face

You can unlock the screen with your face instead of using a pattern, PIN, or password.

- 1 On the Settings screen, tap **Biometrics and security** → **Face recognition**.
- 2 Unlock the screen using the preset screen lock method.
- 3 Tap the **Face unlock** switch to activate it.



If you want to reduce the possibility of recognising faces in photos or videos, tap the **Faster recognition** switch to deactivate it. This may decrease the face recognition speed.

- 4 On the locked screen, look at the screen.

When your face is recognised, you can unlock the screen without using any additional screen lock method. If your face is not recognised, use the preset screen lock method.

Fingerprint recognition

In order for fingerprint recognition to function, your fingerprint information needs to be registered and stored in your device. After registering, you can set the device to use your fingerprint for the features below:

- Samsung Pass (Samsung account verification and web sign-in)
- Screen lock
- Secure Folder



- This feature may not be available depending on the region or service provider.
- Fingerprint recognition uses the unique characteristics of each fingerprint to enhance the security of your device. The likelihood of the fingerprint sensor confusing two different fingerprints is very low. However, in rare cases where separate fingerprints are very similar the sensor may recognise them as identical.
- If you use your fingerprint as a screen lock method, your fingerprint cannot be used to unlock the screen for the first time after turning on the device. To use the device, you must unlock the screen using the pattern, PIN, or password you set when registering the fingerprint. Be careful not to forget your pattern, PIN, or password.
- If your fingerprint is not recognised, unlock the device using the pattern, PIN, or password you set when registering the fingerprint, and then re-register your fingerprints. If your pattern, PIN, or password is forgotten, you will not be able to use the device if you do not reset it. Samsung is not responsible for any data loss or inconvenience caused by forgotten unlock codes.
- If you change the screen lock method to **Swipe** or **None**, which are not secure, all of your biometric data will be deleted. If you want to use your biometric data in apps or features, you must register your biometric data again.

For better fingerprint recognition

When you scan your fingerprints on the device, be aware of the following conditions that may affect the feature's performance:

- The Power key contains a fingerprint recognition sensor. Ensure that the fingerprint recognition sensor is not scratched or damaged by metal objects, such as coins, keys, and necklaces.
- Covering the fingerprint recognition sensor with protective films, stickers, or other accessories may decrease the fingerprint recognition rate. If the fingerprint recognition sensor is initially covered with a protective film, remove it before using the fingerprint recognition sensor.
- Ensure that the fingerprint recognition sensor and your fingers are clean and dry.
- The device may not recognise fingerprints that are affected by wrinkles or scars.
- The device may not recognise fingerprints from small or thin fingers.
- If you bend your finger or use a fingertip, the device may not recognise your fingerprints. Make sure to cover the entire fingerprint recognition sensor with your finger.
- To improve recognition performance, register fingerprints of the hand used most often to perform tasks on the device.
- In dry environments, static electricity can build up in the device. Avoid using this feature in dry environments or before using the feature, discharge static electricity by touching a metal object.

Registering fingerprints

- 1 On the Settings screen, tap **Biometrics and security** → **Fingerprints**.
- 2 Unlock the screen using the preset screen lock method.
If you have not set a screen lock method, create one.

- 3 Place your finger on the Power key.

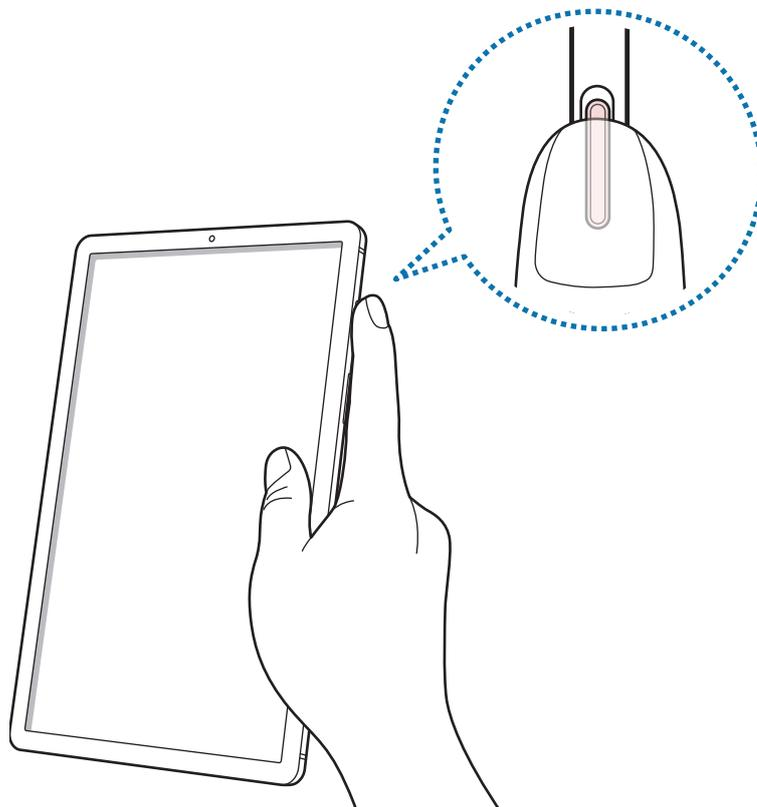

After the device detects your finger, lift it up and place it on the Power key again.

Repeat this action until the fingerprint is registered. When you are finished registering your fingerprints, tap **Done**.

Deleting registered fingerprints

You can delete registered fingerprints.

- 1 On the Settings screen, tap **Biometrics and security** → **Fingerprints**.
- 2 Unlock the screen using the preset screen lock method.
- 3 Select a fingerprint to delete and tap **Remove** → **Remove**.

Using Samsung Pass

When you register your fingerprints to Samsung Pass, you can use them to easily verify your identity or sign in to websites. Refer to [Samsung Pass](#) for more information.

Unlocking the screen with your fingerprints

You can unlock the screen with your fingerprint instead of using a pattern, PIN, or password.

- 1 On the Settings screen, tap **Biometrics and security** → **Fingerprints**.
- 2 Unlock the screen using the preset screen lock method.
- 3 Tap the **Fingerprint unlock** switch to activate it.
- 4 On the locked screen, place your finger on the Power key and scan your fingerprint.

Samsung Pass

Samsung Pass allows you to sign in to your Samsung account, websites, or apps more easily and securely via your biometric data rather than entering your login information. Also, Samsung Pass allows you to enter the personal information, such as your address or payment card information, more easily and quickly via your registered biometric data.

Register your biometric data to Samsung Pass and set to sign in to supported websites or apps using the data via Samsung Pass.



- To use this feature, your device must be connected to a Wi-Fi or mobile network.
- To use this feature, you must register and sign in to your Samsung account. For more information, refer to [Samsung account](#).
- The website sign-in feature is only available for websites that you access via the **Internet** app. Some websites may not support this feature.
- Registered biometric data and saved payment card information are only saved to your device and are not synced with other devices or servers.

Registering Samsung Pass

Before using Samsung Pass, register your biometric data to Samsung Pass.

- 1 On the Settings screen, tap **Biometrics and security** → **Samsung Pass**.
- 2 Tap **Sign-in**, enter your Samsung account ID and password, and then tap **Sign in**.
- 3 Agree to the terms and conditions of Samsung Pass.
- 4 Tap **Fingerprints** and register your fingerprints.
Refer to [Fingerprint recognition](#) for more information.
- 5 Scan your fingerprint and tap **Next** to complete the Samsung Pass registration.

If the **Add Samsung Pass to Home screen** option is ticked, the Samsung Pass icon will be added on the Home screen.

If the **Use Samsung Pass instead of Samsung account password** option is ticked, you can use your registered biometric data to verify your identity instead of entering the Samsung account password.

Verifying the Samsung account password

You can use your registered biometric data to verify your identity instead of entering your Samsung account password when, for example, you purchase content from **Galaxy Store**.

- 1 On the Settings screen, tap **Biometrics and security** → **Samsung Pass**.
- 2 Unlock the screen using the preset screen lock method.
- 3 Tap  → **Settings** → **Samsung account**, and then tap the **Verify with Samsung Pass** switch to activate it.

Using Samsung Pass to sign in to websites

You can use Samsung Pass to easily sign in to websites that support ID and password autofill.

- 1 Open a website that you want to sign in to.
- 2 Enter your user name and password, and then tap the website's sign in button.
- 3 When a pop-up window asking whether you want to save the sign-in information appears, tick **Sign in with Samsung Pass** and tap **Remember**.

You can now use the biometric data you registered to Samsung Pass when signing in to the website.

Using Samsung Pass to sign in to apps

You can use Samsung Pass to easily sign in to apps that support ID and password autofill.

- 1 Open an app that you want to sign in to.
- 2 Enter your user name and password, and then tap the app's sign in button.
- 3 When a pop-up window asking whether you want to save the sign-in information appears, tap **Save**.

You can now use the biometric data you registered to Samsung Pass when signing in to the app.

Managing sign-in information

View the list of websites and apps you have set to use Samsung Pass and manage your sign-in information.

- 1 On the Settings screen, tap **Biometrics and security** → **Samsung Pass**.
- 2 Unlock the screen using the preset screen lock method.
- 3 Tap **Sign-in** and select a website or app from the list.
- 4 Tap **Edit** and modify your ID, password, and the website's or app's name.
To delete the website or app, tap **Delete**.

Using Samsung Pass with websites and apps

When using websites or apps that support Samsung Pass, you can easily sign in with Samsung Pass.

To see the list of websites and apps that support Samsung Pass, on the Settings screen, tap **Biometrics and security** → **Samsung Pass**, unlock the screen using your preset screen lock method, and then tap  → **Partners**. If there are no websites or apps that support Samsung Pass, **Partners** will not appear.



- Available websites and apps may vary depending on the region or service provider.
- Samsung is not responsible for any loss or inconvenience caused by signing in to websites or apps via Samsung Pass.

Entering your personal information automatically

You can use Samsung Pass to easily enter your address or payment card information on apps that support personal information autofill.

- 1 On the Settings screen, tap **Biometrics and security** → **Samsung Pass**.
- 2 Unlock the screen using the preset screen lock method.
- 3 Tap **Autofill forms** and select **Add address** or **Add card**.
- 4 Enter the information and tap **Save**.

You can now use the biometric data you registered to Samsung Pass when entering the personal information automatically on supported apps.

Deleting your Samsung Pass data

You can delete your biometric data, sign-in information, and app data registered to Samsung Pass. Your agreement to the terms and conditions and your Samsung account will remain active.

- 1 On the Settings screen, tap **Biometrics and security** → **Samsung Pass**.
- 2 Unlock the screen using the preset screen lock method.
- 3 Tap **⋮** → **Settings** → **Delete data**.
- 4 Enter your Samsung account password and tap **OK**.

Your Samsung Pass data will be deleted.

Secure Folder

Secure Folder protects your private content and apps, such as photos and contacts, from being accessed by others. You can keep your private content and apps secure even when the device is unlocked.

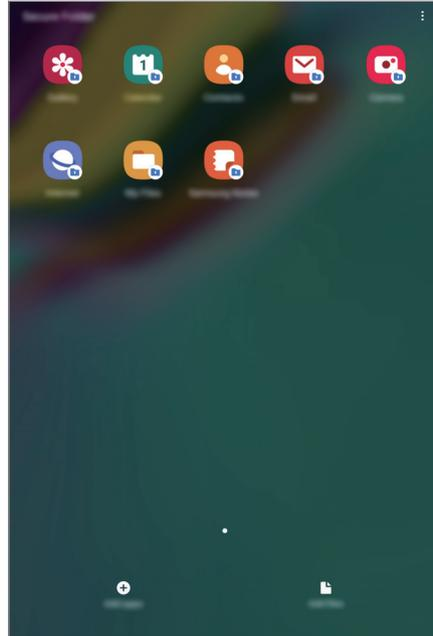

Secure Folder is a separate, secured storage area. The data in Secure Folder cannot be transferred to other devices via unapproved sharing methods, such as USB or Wi-Fi Direct. Attempting to customise the operating system or modifying software will cause Secure Folder to be automatically locked and inaccessible. Before saving data in Secure Folder, make sure to back up a copy of the data in another secure location.

Setting up Secure Folder

- 1 Launch the **Settings** app and tap **Biometrics and security** → **Secure Folder**.
- 2 Tap **Continue**.
- 3 Enter your Samsung account ID and password and tap **Sign in**.
- 4 Select a lock method to use for Secure Folder and follow the on-screen instructions to complete the setup.

To change the name or icon colour of Secure Folder, tap  → **Customise icon**.



- When you launch the **Secure Folder** app, you must unlock the app using your preset lock method.
- If you forget your Secure Folder unlock code, you can reset it using your Samsung account. Tap the reset button at the bottom of the locked screen, and enter your Samsung account password.

Setting auto lock for Secure Folder

Set the device to automatically lock Secure Folder when it is not being used.

- 1 Launch the **Secure Folder** app and tap  → **Settings** → **Auto lock Secure Folder**.
- 2 Select a lock option.



To manually lock your Secure Folder, tap  → **Lock**.

Moving content to Secure Folder

Move content, such as photos and contacts, to Secure Folder. The following actions are an example of moving an image from the default storage to Secure Folder.

- 1 Launch the **Secure Folder** app and tap **Add files**.
- 2 Tap **Images**, tick images to move, and then tap **Done**.
- 3 Tap **Move**.
The selected items will be deleted from the original folder and moved to Secure Folder.
To copy items, tap **Copy**.



The method for moving content may vary depending on the content type.

Moving content from Secure Folder

Move content from Secure Folder to the corresponding app in the default storage. The following actions are an example of moving an image from Secure Folder to the default storage.

- 1 Launch the **Secure Folder** app and tap **Gallery**.
- 2 Select an image and tap **⋮** → **Move out of Secure Folder**.
The selected items will be moved to **Gallery** in the default storage.

Adding apps

Add an app to use in Secure Folder.

- 1 Launch the **Secure Folder** app and tap **Add apps**.
- 2 Tick one or more apps installed on the device and tap **Add**.
To install apps from **Play Store** or **Galaxy Store**, tap **Download from Play Store** or **Download from Galaxy Store**.

Removing apps from Secure Folder

Tap and hold an app to delete, and tap **Uninstall**.

Adding accounts

Add your Samsung and Google accounts, or other accounts, to sync with the apps in Secure Folder.

- 1 Launch the **Secure Folder** app and tap **⋮** → **Settings** → **Accounts** → **Add account**.
- 2 Select an account service.
- 3 Follow the on-screen instructions to complete the account setup.

Hiding Secure Folder

You can hide the Secure Folder shortcut from the Apps screen.

Launch the **Secure Folder** app, tap **⋮** → **Settings**, and then tap the **Show Secure Folder** switch to deactivate it.

Alternatively, drag the status bar downwards to open the notification panel. Then, swipe downwards on the notification panel and tap **Secure Folder** to deactivate the feature.

Backing up and restoring Secure Folder

Back up content and apps in Secure Folder to Samsung Cloud using your Samsung account and restore them later.

Backing up data

- 1 Launch the **Secure Folder** app and tap **⋮** → **Settings** → **Backup and restore**.
- 2 Tap **Add account** and sign in to your Samsung account.
- 3 Tap **Back up Secure Folder data**.
- 4 Tick items you want to back up and tap **Back up**.
Data will be backed up to Samsung Cloud.

Restoring data

- 1 Launch the **Secure Folder** app and tap **⋮** → **Settings** → **Backup and restore**.
- 2 Tap **Restore**.
- 3 Tap **▼** to select a device to restore the data.
- 4 Select the data types you want to restore and tap **Restore**.
Backed up data will be restored to your device.

Uninstalling Secure Folder

You can uninstall Secure Folder, including the content and apps in it.

Launch the **Secure Folder** app and tap **⋮** → **Settings** → **More settings** → **Uninstall**.

To back up content before uninstalling Secure Folder, tick **Move media files out of Secure Folder** and tap **Uninstall**. To access data backed from Secure Folder, launch the **My Files** app and tap **Internal storage** → **Secure Folder**.



Notes saved in **Samsung Notes** will not be backed up.

Accounts and backup

Options

Sync, back up, or restore your device's data using Samsung Cloud. You can also register and manage accounts, such as your Samsung account or Google account, or transfer data to or from other devices via Smart Switch.

On the Settings screen, tap **Accounts and backup**.

- **Accounts:** Add your Samsung and Google accounts, or other accounts, to sync with.
- **Users:** Set up additional user accounts for other users to use the device with personalised settings, such as email accounts, wallpaper preferences, and more. Refer to [Users](#) for more information.



This feature may not be available depending on the region or service provider.

- **Backup and restore:** Keep your personal information, app data, and settings safe on your device. You can back up your sensitive information and access it later. You must sign in to your Google or Samsung account to back up or restore data.
- **Samsung Cloud:** Manage the content that you want to store securely in Samsung Cloud. Check the usage status of your Samsung Cloud storage, and sync, back up, and restore your data. Refer to [Samsung Cloud](#) for more information.
- **Smart Switch:** Launch Smart Switch and transfer data from your previous device. Refer to [Transferring data from your previous device \(Smart Switch\)](#) for more information.



Regularly back up your data to a safe location, such as Samsung Cloud or a computer, so that you can restore it if the data is corrupted or lost due to an unintended factory data reset.

Users

Set up additional user accounts for other users to use the device with personalised settings, such as email accounts, wallpaper preferences, and more. Following types of user accounts are available:



This feature may not be available depending on the region or service provider.

- **Administrator:** The administrator account is created only when setting up the device for the first time, and cannot be created more than one. This account has full control of the device including user account management. You can add or delete user accounts only when using this account.
- **Guest:** This account allows guests to access the device. Information and data used during a guest session is temporarily stored. Each time you use this account, you are asked whether to continue the previous guest session or reset it.
- **User:** This account allows users to access their own apps and content, and customise the device settings that affect all accounts.
- **User (restricted profile):** A restricted account can only access the apps and content allowed by the administrator account, and cannot use the services that require logging in. (SM-T720, SM-T727)

Adding users

1 On the Settings screen, tap **Accounts and backup** → **Users**.

2 ► **SM-T725:** Tap **Add user or profile** → **OK** → **Set up now**.

► **SM-T720, SM-T727:** Tap **Add user or profile** → **User** → **OK** → **Set up now**.

The device will switch to a new user account and the default locked screen will appear on the screen.

3 Unlock the device and follow the on-screen instructions to complete the account setup.

Adding restricted profiles (SM-T720, SM-T727)

- 1 On the Settings screen, tap **Accounts and backup** → **Users**.
- 2 Tap **Add user or profile** → **User (restricted profile)**.
If you are not using a secure screen lock method with the administrator account, follow the on-screen instructions to set one up.
- 3 Select the apps and content that restricted users are allowed to access.

Switching users

Tap the user account icon at the top of the locked screen and select an account to switch to.



Locked screen

Managing users

► **SM-T725:** When using the administrator account, you can delete accounts or change account settings.

To delete a user account, tap  next to the account and then tap **Delete user**.

To change an account's settings, tap  next to an account.

► **SM-T720, SM-T727:** When using the administrator account, you can delete accounts or change the settings for restricted accounts.

To delete a user account, tap  next to the account and then tap **Delete**.

To change the settings for a restricted account, tap  next to an account. You can delete the account by tapping .

Samsung Cloud

Back up data from your previous device to Samsung Cloud and restore the data to your new device. You can also sync data saved in your device with Samsung Cloud and view data saved on the Samsung Cloud. You must register and sign in to your Samsung account to use Samsung Cloud. Refer to [Samsung account](#) for more information.

Backing up data from your previous device

1 On your previous device, sign in to your Samsung account.

2 Launch the **Settings** app, select the backup option, and back up your data.



- If your device supports Samsung Cloud, launch the **Settings** app, tap **Accounts and backup** → **Samsung Cloud** → **Back up this tablet**, tick items you want to back up, and then tap **Back up** to back up your data.
- The data backup method may vary depending on your model.
- Some data will not be backed up. To check which data will be backed up, launch the **Settings** app, tap **Accounts and backup** → **Samsung Cloud** → **Back up this tablet**.
- To view the backup data for each device in your Samsung Cloud, launch the **Settings** app, tap **Accounts and backup** → **Samsung Cloud** → **Restore data** → ▼, and then select a device you want.

Restoring data from your previous device

- 1 On your new device, launch the **Settings** app and tap **Accounts and backup** → **Samsung Cloud**.
- 2 Tap **Restore data** → ▼ and select a previous device.
- 3 Tick the data types you want to restore and tap **Restore**.

Syncing data from your device

You can sync data saved in your device, such as images, videos, and events, with Samsung Cloud and access it from other devices.

- 1 On your new device, launch the **Settings** app and tap **Accounts and backup** → **Samsung Cloud**.
- 2 Tap ⋮ → **Settings** → **Sync and auto backup settings** → **Sync**.
- 3 Tap the switches next to the items you want to sync with.



You can check the saved data or change the settings by tapping the **Gallery**, **Other synced data**, or **Samsung Cloud Drive**.

Google

Configure settings for some features provided by Google.

On the Settings screen, tap **Google**.

Advanced features

Activate advanced features and change the settings that control them.

On the Settings screen, tap **Advanced features**.



Excessive shaking or an impact to the device may cause an unintended input for some features using sensors.

- **Samsung DeX:** Set the device to use like a computer. Refer to [Samsung DeX](#) for more information.
- **Accessories:** Change the accessory settings.
- **Daily Board:** Set the device to show a slideshow with selected images. Refer to [Daily Board](#) for more information.
- **Smart pop-up view:** Select apps to view their notifications via pop-up windows. When using this feature, you can quickly view the contents via pop-up windows by tapping the icon on the screen.



This feature is only available in apps that support the Multi window feature.

- **Smart capture:** Set the device to capture the current screen and scrollable area, and crop and share the screenshot immediately.
- **Direct share:** Set the device to display the people you contacted on the sharing options panel to allow you to share content directly.
- **Reduce animations:** Set the device to reduce certain screen effects if you are sensitive to animations or screen movement.
- **Motions and gestures:** Activate the motion feature and configure settings.
- **Game Launcher:** Activate the Game Launcher. Refer to [Game Launcher](#) for more information.

Digital wellbeing

View the daily usage history of your device. You can see information such as how long the screen was on and how many times you opened apps or used certain features. You can also limit usage time or change the notification settings for each app.

On the Settings screen, tap **Digital wellbeing**.

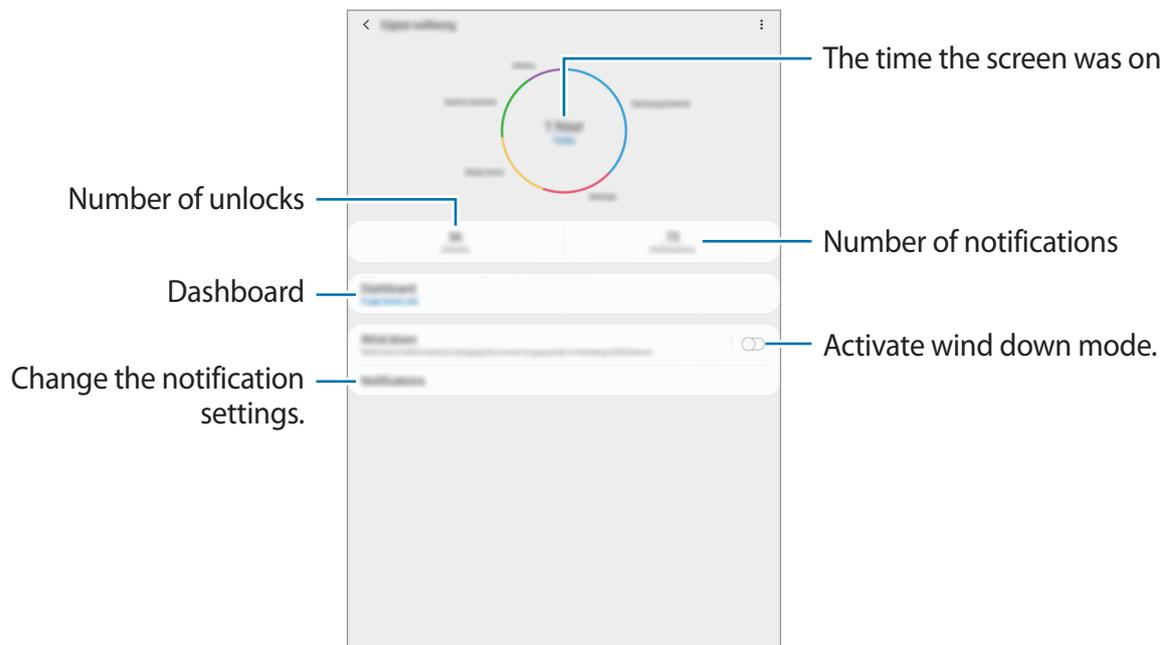

Setting timers for apps

You can limit the daily usage time for each app by setting a timer. When you reach the limit, the app will be deactivated and you cannot use it.

- 1 On the Settings screen, tap **Digital wellbeing** → **Dashboard**.
- 2 Tap **No timer** next the app you want and set the time.

Activating wind down mode

You can activate wind down mode to reduce eye strain before sleeping and prevent your sleep from being disturbed.

- 1 On the Settings screen, tap **Digital wellbeing** → **Wind down** and tap the **Turn on now** switch to activate it.
- 2 Turn on the switch to activate the feature you want.
 - **Greyscale:** Displays colours on the screen as grey tones.
 - **Do not disturb:** Set the device to mute notification sounds and media, except for allowed exceptions.
- 3 To set the schedule to activate wind down mode, tap the **Turn on as scheduled** switch to activate it, tap **Set schedule**, and then set the time.

Device care

The device care feature provides an overview of the status of your device's battery, storage, memory, and system security. You can also automatically optimise the device with a tap of your finger.



Using the quick optimisation feature

On the Settings screen, tap **Device care** → **Fix now** or **Optimise now**.

The quick optimisation feature improves device performance through the following actions.

- Clearing some memory.
- Deleting unnecessary files and closing apps running in the background.
- Managing abnormal battery usage.
- Scanning for crashed apps and malware.

Battery

Check the remaining battery power and time to use the device. For devices with low battery levels, conserve battery power by activating power saving features.

On the Settings screen, tap **Device care** → **Battery**.



- The usage time left shows the time remaining before the battery power runs out. Usage time left may vary depending on your device settings and operating conditions.
- You may not receive notifications from some apps that use power saving mode.

Managing battery usage

Select a power mode that suits your device usage purposes.

Tap **Power mode** and select an option.

- **Optimised:** Optimised for a balance between the device's performance and battery usage.
- **Medium power saving:** Activate power saving mode to extend the battery's usage time.
- **Maximum power saving**
 - ▶ **SM-T725, SM-T727:** In maximum power saving mode, the device decreases battery consumption by activating night mode and limiting the apps and features available. Network connections, except for the mobile network, will be deactivated.
 - ▶ **SM-T720:** In maximum power saving mode, the device decreases battery consumption by activating night mode and limiting the apps and features available. Network connections will be deactivated.

You can set the device to charge the battery more quickly. Tap  → **Settings** and tap the **Fast cable charging** switch to activate it.

Managing battery usage for each app

You can save battery power by preventing apps that are running in the background from using battery power when they are not being used. Select apps from the apps list and tap the **Put app to sleep** switch to activate the feature. Also, tap  → **Settings** and set up the options under **App power management**.

Storage

Check the status of the used and available memory.

On the Settings screen, tap **Device care** → **Storage**.



- The actual available capacity of the internal memory is less than the specified capacity because the operating system and default apps occupy part of the memory. The available capacity may change when you update the device.
- You can view the available capacity of the internal memory in the Specification section for your device on the Samsung website.

Managing the memory

To delete residual files, such as cache, tap **CLEAN NOW**. To delete files or uninstall apps that you do not use any more, select a category under **User data**. Then, tick items to select and tap **DELETE** or **UNINSTALL**.

Memory

On the Settings screen, tap **Device care** → **Memory**.

To speed up your device by stopping apps running in the background, tick apps from the apps list, and tap **CLEAN NOW**.

Security

Check the device's security status. This feature scans your device for malware.

On the Settings screen, tap **Device care** → **Security** → **Scan tablet**.

Apps

Manage the device's apps and change their settings. You can view the apps' usage information, change their notification or permission settings, or uninstall or disable unnecessary apps.

On the Settings screen, tap **Apps**.

General management

Customise your device's system settings or reset the device.

On the Settings screen, tap **General management**.

- **Language and input:** Select device languages and change settings, such as keyboards and voice input types. Some options may not be available depending on the selected language. Refer to [Adding device languages](#) for more information.
- **Date and time:** Access and alter the settings to control how the device displays the time and date.



If the battery remains fully discharged, the time and date is reset.

- **Contact us:** Ask questions or view frequently asked questions. Refer to [Samsung Members](#) for more information.
- **Reset:** Reset your device's settings or perform a factory data reset. You can reset all your settings, or only network settings, or accessibility settings. You can also set the device to restart at a preset time for device optimisation.

Adding device languages

You can add languages to use on your device.

1 On the Settings screen, tap **General management** → **Language and input** → **Language** → **Add language**.

To view all the languages that can be added, tap  → **All languages**.

2 Select a language to add.

3 To set the selected language as the default language, tap **Set as default**. To keep the current language setting, tap **Keep current**.

The selected language will be added to your languages list. If you changed the default language, the selected language will be added to the top of the list.

To change the default language from your languages list, drag  next to a language and move it to the top of the list. Then, tap **Apply**. If an app does not support the default language, the next supported language in the list will be used.

Accessibility

Configure various settings to improve accessibility to the device.

On the Settings screen, tap **Accessibility**.

- **Screen reader:** Activate Voice Assistant, which provides voice feedback. To view help information to learn how to use this feature, tap **Tutorial**.
- **Visibility enhancements:** Customise the settings to improve accessibility for visually impaired users.
- **Hearing enhancements:** Customise the settings to improve accessibility for users with hearing impairment.
- **Interaction and dexterity:** Customise the settings to improve accessibility for users who have reduced dexterity.
- **Advanced settings:** Configure settings for Direct access and notification features.
- **Installed services:** View accessibility services installed on the device.

Software update

Update your device's software via the firmware over-the-air (FOTA) service. You can also schedule software updates.

On the Settings screen, tap **Software update**.



If emergency software updates are released for your device's security and to block new types of security threats, they will be installed automatically without your agreement.

- **Download and install:** Check for and install updates manually.
- **Auto download over Wi-Fi:** Set the device to download updates automatically when connected to a Wi-Fi network.
- **Last update:** View information about the last software update.

Security updates information

Security updates are provided to strengthen the security of your device and protect your personal information. For security updates for your model, visit security.samsungmobile.com.



The website supports only some languages.

User manual

View help information to learn how to use the device and apps or configure important settings.

On the Settings screen, tap **User manual**.

About tablet

Access your device's information.

On the Settings screen, tap **About tablet**.

To change your device's name, tap **Edit**.

- **Status**
 - ▶ **SM-T725, SM-T727**: View various device information, such as the SIM card status, Wi-Fi MAC address, and serial number.
 - ▶ **SM-T720**: View various device information, such as the Wi-Fi MAC address and serial number.
- **Legal information**: View legal information related to the device, such as safety information and the open source licence.
- **Software information**: View the device's software information, such as its operating system version and firmware version.
- **Battery information**: View the device's battery status and information.

Appendix

Troubleshooting

Before contacting a Samsung Service Centre, please attempt the following solutions. Some situations may not apply to your device.

When you turn on your device or while you are using the device, it prompts you to enter one of the following codes:

- **Password:** When the device lock feature is enabled, you must enter the password you set for the device.
- **PIN:** When using the device for the first time or when the PIN requirement is enabled, you must enter the PIN supplied with the SIM or USIM card. You can disable this feature by using the Lock SIM card menu.
- **PUK:** Your SIM or USIM card is blocked, usually as a result of entering your PIN incorrectly several times. You must enter the PUK supplied by your service provider.
- **PIN2:** When you access a menu requiring the PIN2, you must enter the PIN2 supplied with the SIM or USIM card. For more information, contact your service provider.

Your device displays network or service error messages

- When you are in areas with weak signals or poor reception, you may lose reception. Move to another area and try again. While moving, error messages may appear repeatedly.
- You cannot access some options without a subscription. For more information, contact your service provider.

Your device does not turn on

When the battery is completely discharged, your device will not turn on. Fully charge the battery before turning on the device.

The touchscreen responds slowly or improperly

- If you attach a screen protector or optional accessories to the touchscreen, the touchscreen may not function properly.
- If you are wearing gloves, if your hands are not clean while touching the touchscreen, or if you tap the screen with sharp objects or your fingertips, the touchscreen may malfunction.
- The touchscreen may malfunction in humid conditions or when exposed to water.
- Restart your device to clear any temporary software bugs.
- Ensure that your device software is updated to the latest version.
- If the touchscreen is scratched or damaged, visit a Samsung Service Centre.

Your device freezes or encounters a fatal error

Try the following solutions. If the problem is still not resolved, contact a Samsung Service Centre.

Restarting the device

If your device freezes or hangs, you may need to close apps or turn off the device and turn it on again.

Forcing restart

If your device is frozen and unresponsive, press and hold the Power key and the Volume Down key simultaneously for more than 7 seconds to restart it.

Resetting the device

If the methods above do not solve your problem, perform a factory data reset.

Launch the **Settings** app and tap **General management** → **Reset** → **Factory data reset** → **Reset** → **Delete all**. Before performing the factory data reset, remember to make backup copies of all important data stored in the device.

Calls are not connected (SM-T725)

- Ensure that you have accessed the right cellular network.
- Ensure that you have not set call barring for the phone number you are dialling.
- Ensure that you have not set call barring for the incoming phone number.

Others cannot hear you speaking on a call (SM-T725)

- Ensure that you are not covering the built-in microphone.
- Ensure that the microphone is close to your mouth.
- If using an earphone, ensure that it is properly connected.

Sound echoes during a call (SM-T725)

Adjust the volume by pressing the Volume key or move to another area.

▶ SM-T725: A cellular network or the Internet is often disconnected or audio quality is poor

▶ SM-T720, SM-T727: The Internet is often disconnected

- Ensure that you are not blocking the device's internal antenna.
- When you are in areas with weak signals or poor reception, you may lose reception. You may have connectivity problems due to issues with the service provider's base station. Move to another area and try again.
- When using the device while moving, wireless network services may be disabled due to issues with the service provider's network.

The battery icon is empty

Your battery is low. Charge the battery.

The battery does not charge properly (For Samsung-approved chargers)

- Ensure that the charger is connected properly.
- Visit a Samsung Service Centre and have the battery replaced.

The battery depletes faster than when first purchased

- When you expose the device or the battery to very cold or very hot temperatures, the useful charge may be reduced.
- Battery consumption will increase when you use certain features or apps, such as GPS, games, or the Internet.
- The battery is consumable and the useful charge will get shorter over time.

Error messages appear when launching the camera

Your device must have sufficient available memory and battery power to operate the camera app. If you receive error messages when launching the camera, try the following:

- Charge the battery.
- Free some memory by transferring files to a computer or deleting files from your device.
- Restart the device. If you are still having trouble with the camera app after trying these tips, contact a Samsung Service Centre.

Photo quality is poorer than the preview

- The quality of your photos may vary, depending on the surroundings and the photography techniques you use.
- If you take photos in dark areas, at night, or indoors, image noise may occur or images may be out of focus.

Error messages appear when opening multimedia files

If you receive error messages or multimedia files do not play when you open them on your device, try the following:

- Free some memory by transferring files to a computer or deleting files from your device.
- Ensure that the music file is not Digital Rights Management (DRM)-protected. If the file is DRM-protected, ensure that you have the appropriate licence or key to play the file.
- Ensure that the file formats are supported by the device. If a file format is not supported, such as DivX or AC3, install an app that supports it. To confirm the file formats that your device supports, visit www.samsung.com.
- Your device supports photos and videos captured with the device. Photos and videos captured by other devices may not work properly.
- Your device supports multimedia files that are authorised by your network service provider or providers of additional services. Some content circulated on the Internet, such as ringtones, videos, or wallpapers, may not work properly.

Bluetooth is not working well

If another Bluetooth device is not located or there are connection problems or performance malfunctions, try the following:

- Ensure that the device you wish to connect with is ready to be scanned or connected to.
- Ensure that your device and the other Bluetooth device are within the maximum Bluetooth range (10 m).
- On your device, launch the **Settings** app, tap **Connections**, and then tap the **Bluetooth** switch to re-activate it.
- On your device, launch the **Settings** app, tap **General management** → **Reset** → **Reset network settings** → **Reset settings** to reset network settings. You may lose registered information when performing the reset.

If the tips above do not solve the problem, contact a Samsung Service Centre.

A connection is not established when you connect the device to a computer

- Ensure that the USB cable you are using is compatible with your device.
- Ensure that you have the proper driver installed and updated on your computer.
- If you are a Windows XP user, ensure that you have Windows XP Service Pack 3 or higher installed on your computer.

Your device cannot find your current location

GPS signals may be obstructed in some locations, such as indoors. Set the device to use Wi-Fi or a mobile network to find your current location in these situations.

Data stored in the device has been lost

Always make backup copies of all important data stored in the device. Otherwise, you cannot restore data if it is corrupted or lost. Samsung is not responsible for the loss of data stored in the device.

A small gap appears around the outside of the device case

- This gap is a necessary manufacturing feature and some minor rocking or vibration of parts may occur.
- Over time, friction between parts may cause this gap to expand slightly.

There is not enough space in the device's storage

Delete unnecessary data, such as cache, using the device care feature or manually delete unused apps or files to free up storage space.

The Apps button does not appear on the Home screen

Without using the Apps button, you can open the Apps screen by swiping upwards or downwards on the Home screen. To display the Apps button at the bottom of the Home screen, launch the **Settings** app, tap **Display** → **Home screen**, and then tap the **Apps button** switch to activate it.

The Home button does not appear

The navigation bar containing the Home button may disappear while using certain apps or features. To view the navigation bar, drag upwards from the bottom of the screen.

The screen brightness adjustment bar does not appear on the notification panel

Open the notification panel by dragging the status bar downwards, and then drag the notification panel downwards. Tap  next to the brightness adjustment bar and tap the **Show control on top** switch to activate it.

Samsung Cloud does not work

- Ensure that you are connected to a network properly.
- During a Samsung Cloud's service check, you cannot use Samsung Cloud. Try again later.

Removing the battery (SM-T720, SM-T725)

- **To remove the battery, contact an authorised service centre. To obtain battery removal instructions, please visit www.samsung.com/global/ecodesign_energy.**
- For your safety, you **must not attempt to remove** the battery. If the battery is not properly removed, it may lead to damage to the battery and device, cause personal injury, and/or result in the device being unsafe.
- Samsung does not accept liability for any damage or loss (whether in contract or tort, including negligence) which may arise from failure to precisely follow these warnings and instructions, other than death or personal injury caused by Samsung's negligence.



This feature may not be available depending on the region or service provider.

Copyright

Copyright © 2019 Samsung Electronics

This manual is protected under international copyright laws.

No part of this manual may be reproduced, distributed, translated, or transmitted in any form or by any means, electronic or mechanical, including photocopying, recording, or storing in any information storage and retrieval system, without the prior written permission of Samsung Electronics.

Trademarks

- SAMSUNG and the SAMSUNG logo are registered trademarks of Samsung Electronics.
- Bluetooth® is a registered trademark of Bluetooth SIG, Inc. worldwide.
- Wi-Fi®, Wi-Fi Protected Setup™, Wi-Fi Direct™, Wi-Fi CERTIFIED™, and the Wi-Fi logo are registered trademarks of the Wi-Fi Alliance.
- Manufactured under license from Dolby Laboratories. Dolby, Dolby Atmos, and the double-D symbol are trademarks of Dolby Laboratories.
- All other trademarks and copyrights are the property of their respective owners.