

SONY

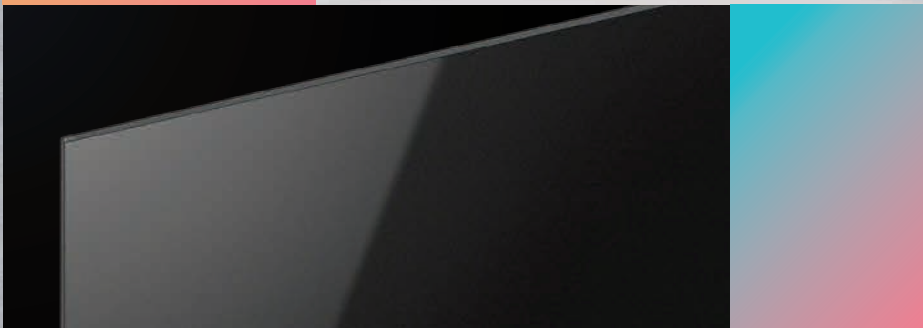

**BRAVIA™ Professional Displays
BZ35F Series**

BZ

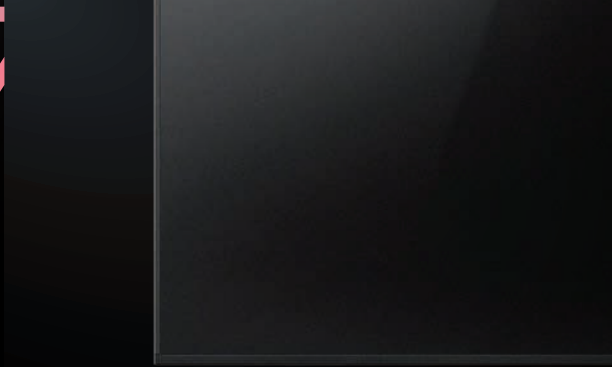

Displays Optimized for Business

Professional performance for meeting rooms and digital signage — BZ35F Series

Professional display performance coupled with functionality for business use makes the BZ35F Series ideal for a wide array of environments. Whether you're considering displays for use in stores, offices, schools, or hospitals, let our Professional Display BZ35F Series put your best image forward.



BARGAIN

MODERN

PROVIDE

PROVIDE



Key Features



Designed for versatile business use

- High brightness with a variety of display sizes
- IP network and serial communication controls
- Flexible installation to fit any environment

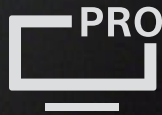

Pro mode for advanced customization

- Detailed customization for a variety of setting menus
- One-step setting optimized for meeting rooms / signage
- Batch import / export of settings via USB memory



Built-in software platform and API

- Simple and easy 4K signage configuration
- Flexible content layout with HTML5
- Over 100 REST APIs for remote monitoring and control



Designed for versatile business use

Variety of display sizes with high brightness

The BZ35F Series includes a variety of sizes from 43" to 85" while keeping the same specifications. All models offer best-in-class brightness of over 500 cd/m² for clearly visible images even in bright meeting rooms or as digital signage.



Easy-to-use remote control (provided)

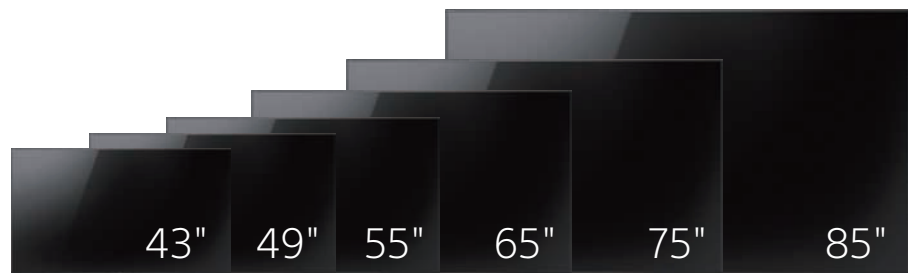

Brightness : 505 cd/m² for 43"/49", 620 cd/m² for 55"/65"/75"/85"

IP network and serial communication controls

The BZ35F Series is controllable both via IP network (wired/wireless LAN) and RS-232C. This controllability makes it possible to incorporate the displays into a variety of existing systems, such as in offices, hotels, and as eye-catching signage.

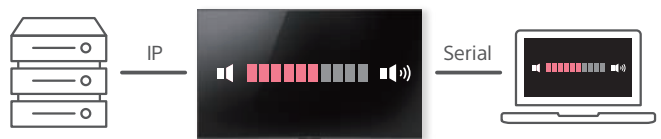

Flexible installation to fit any environment

With the VESA mount compatibility, the BZ35F Series can be installed in the portrait position or tilted position on the ceiling. Since it can be installed in a variety of layouts, the displays are perfect for meeting rooms and classrooms, in corporate or hospital lobbies, and as digital signage in stores and shopping malls.



Portrait



Ceiling mounting*

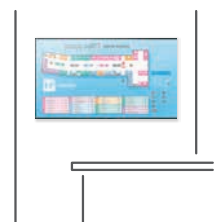

Wall mounting

* currently not available on 75/85"



Pro mode for advanced customization

Detailed customization for a variety of setting menus

The BZ35F Series displays include a wide range of 'Pro Settings' that provide more specific and detailed customization for professional use.

[e.g.1]

By simply designating the URL, the specified web application will automatically launch when the power is turned on.

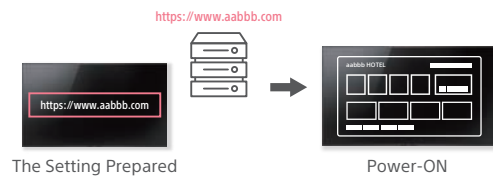

[e.g.2]

Since the input source is automatically switched as the HDMI cable is connected, operation is possible without the need for a remote control.

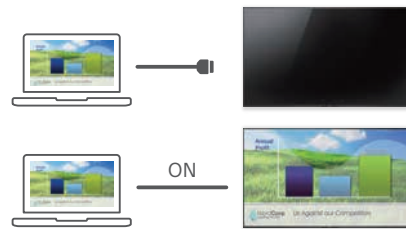

[Examples of customizable items]

Behavior customization	Function restrictions	Integration flexibility
<ul style="list-style-type: none"> • Power-on by HDMI plug-in • "Home" key behavior • Account expiration • Fixed initial input source 	<ul style="list-style-type: none"> • Disable key equipment • Maximum volume • External input source control • Screen mirroring setting 	<ul style="list-style-type: none"> • Export/import setting values • Installation setting for Web applications • Start-up applications setting • Power on/off control with applications

One-step setting optimized for meeting rooms/signage

For business use, displays usually require complicated settings for picture quality, control functions, power source, and the list goes on. With "One-step setting", the optimal settings for meeting rooms and in-store digital signage are pre-set so you can quickly and easily setup the display.

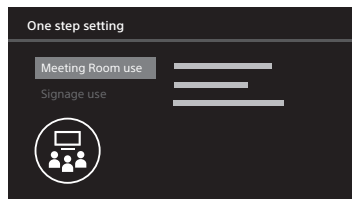

Meeting Room use

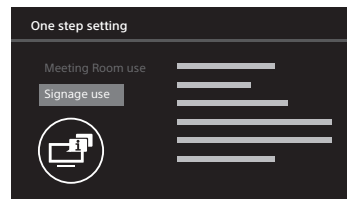

Signage use

Batch import/export of settings via USB memory

Setting up a large number of displays can be a painstaking process. With the BZ35F Series, you can use a USB flash memory to easily import and export the batch settings. This contributes to save time and minimize the risk of setting errors.



Software platform to enhance business applications

Simple and easy 4K signage configuration

You can easily establish 4K digital signage by simply selecting the files or URLs of video, stills, or web pages. It's all manageable via a USB memory; your 4K signage solution is ready to get started on an affordable budget. What's more, 2K content gets automatically upconverted to 4K so even your current content can be displayed with finer results.



Flexible content layout with HTML5

The BZ35F Series offers built-in support for the HTML5 application platform, so it's possible to use HTML5 interactive signage content as well as the portal site for hotel room guests without requiring a set-top box or PC. The content screen can be freely laid out using the 4K video, pictures, or even with the HDMI input.

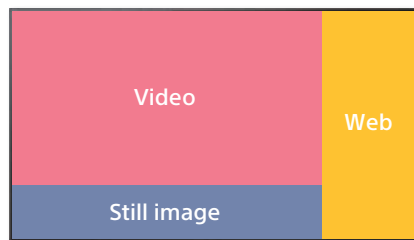

Over 100 REST APIs for remote monitoring and control

With more than 100 REST APIs built-in, monitoring and controls from remote locations and integration with external systems are available. We also provide a free app that enables control of the display via IP.

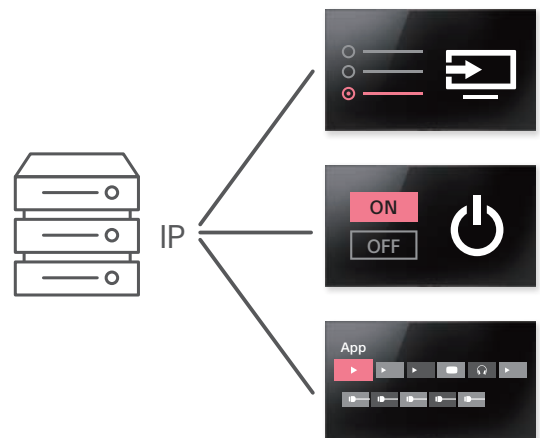

Appearance



Front view



Side view



Back view



Bezel corner



Remote sensor part sticks out 6.8mm width is about 145mm

LED indicator can be disabled by setting

BZ35F Bezel size

Inch	Top	Side	Bottom	Material
85"	17 mm	17 mm	17 mm	
75"	9.6 mm	9.6 mm	15.6 mm	
65"	8.5 mm	8.5 mm	14.1 mm	
55"	8.5 mm	8.5 mm	14.1 mm	
49"	9.3 mm	9.8 mm	18.4 mm	
43"	8.8 mm	9.3 mm	18.4 mm	

Supported video formats

CE Format	
720(1440)x480	60i/60p
720(1440)x576	50i/50p
1280x720	24p/25p/29.97p/30p/50p/60p
1920x1080	24p/25p/29.97p/30p/50i/50p/60i/60p/100p/120p
3840x2160	24p/25p/30p/50p (*1) /60p (*1)
4096x2160	24p/25p/30p/50p (*1) /60p (*1)

(*1) HDMI1/4: YUV420 supported
HDMI2/3: YUV420/422 supported

PC Format	
720x400	70Hz/85Hz
640x350	85Hz
848x480	60Hz
640x480	60Hz/72Hz/75Hz/85Hz
800x600	56Hz/60Hz/75Hz/85Hz
1024x768	60Hz/70Hz/75Hz/85Hz
1280x768	60Hz/75Hz
1360x768	60Hz
1366x768	60Hz
1280x800	60Hz
1152x864	75Hz
1600x900	60Hz
1440x900	60Hz
1280x960	60Hz
1280x1024	60Hz
1400x1050	60Hz
1920x1080	60Hz
1680x1050	60Hz
1600x1200	60Hz
2304x1440	60Hz
2560x1440	60Hz
2048x1536	60Hz
2560x1600	60Hz
2880x1800	60Hz

Specifications

		FW-85BZ35F	FW-75BZ35F	FW-65BZ35F	FW-55BZ35F	FW-49BZ35F	FW-43BZ35F
Panel	Screen size	85"	75"	65"	55"	49"	43"
	Display resolution	QFHD	QFHD	QFHD	QFHD	QFHD	QFHD
	Brightness(cd/m ²)	620	620	620	620	505	505
	Contrast ratio	4000:1	1400:1	1400:1	1400:1	5000:1	1400:1
	Dynamic contrast ratio	500,000:1	500,000:1	500,000:1	500,000:1	400,000:1	400,000:1
	Response time (ms)(*)	6	5	5	5	8	5
	Panel type (IPS / VA)	VA	IPS	IPS	IPS	VA	IPS
	Panel surface	AG	AG	AG	AG	AG	AG
	Haze (%)	2%	3%	3%	3%	2%	3%
	Backlight type	Direct LED	Edge LED	Edge LED	Edge LED	Edge LED	Edge LED
	Aspect ratio	16:9	16:9	16:9	16:9	16:9	16:9
	Viewing angle (Right/Left)	178 (89/89) degree	178 (89/89) degree	178 (89/89) degree	178 (89/89) degree	178 (89/89) degree	178 (89/89) degree
Viewing angle (Up/Down)	178 (89/89) degree	178 (89/89) degree	178 (89/89) degree	178 (89/89) degree	178 (89/89) degree	178 (89/89) degree	
Connectivity	Input	HDMI(4), Composite video, Component video (Y/Pb/Pr), Analogue audio, USB2.0 (2), USB3.1					
	Output	Digital audio, Audio out					
	External control	RS-232C, Ethernet, Wireless LAN					
Video	Compatible with HDR	Yes (HDR10, HLG)					
	Video signal	4096×2160p (24.60Hz), 3840×2160p (24.30,60Hz), 1080p (30,60Hz), 1080i (60Hz), 720p (30,60Hz), 720i/24p, 480p, 480i					
Dimensions	Bezel width (Top/Side/Bottom) (mm)	17/17/17	9.6/9.6/15.6	8.5/8.5/14.1	8.5/8.5/14.1	9.3/9.8/13.4	8.8/9.3/13.4
	Display only (W×H×D) (mm)	1911×1098×73	1673×963×54	1450×836×52	1231×713×52	1098×644×58	965×569×58
	Display with stand (W×H×D) (mm)	1911×1176×429	1673×1031×371	1450×900×315	1231×776×315	1098×703×279	965×628×279
	Package carton (W×H×D) (mm)	2082×1233×369	1884×1083×188	1565×946×179	1332×817×158	1188×776×148	1070×695×148
	VESA® hole pitch (mm)	400×400	400×300	300×300	300×200	200×200	100×200
Weight	Display only (kg)	44.1	38.9	25.6	19.1	13.2	10.8
	Display with stand (kg)	46.2	40.1	26.5	20	13.7	11.3
	Package carton (kg)	64	53	35	26	19	15
Power	Power consumption (w)	378	250	196	170	145	120
	Power consumption (in standby) (W)	0.5	0.5	0.5	0.5	0.5	0.5

Terminals

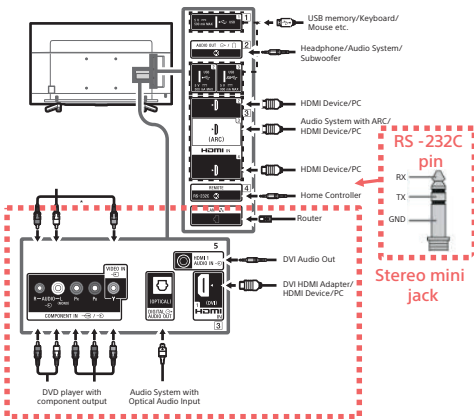

Rear terminals cannot be used for wall mount with limited space

Terminals	Number	Description
Composite Video	1	Rear Hybrid w/Component
Component Video	1	Rear Hybrid w/Composite
HDMI™ Connection(s)	4	3Side, 1Rear (*1) Port 1 : Rear Port 2/3: High-Quality HDMI/Side Port 4: Side
Analog Audio Input(s)	1	Rear
Digital Audio Output(s)	1	Rear
Audio Out	1	Side/Hybrid w/HP and Subwoofer Out
USB	3	Side Port1/2: USB2.0 Port3: USB 3.1 Gen 1
Ethernet Connection(s)	1	Side
Wireless LAN	integrated	Only 2.4GHz supported / 1-12 CH

(*1) High-Quality HDMI: Up to 4K 60p 4:4:4(8bit)/4:2:2(12bit)/4:2:0(10bit)
Others: Up to 4K 60p 4:2:0(8bit)

©2018 Sony Corporation. All rights reserved.
Reproduction in whole or in part without written permission is prohibited.
Features, design, and specifications are subject to change without notice.
The values for weight and dimension are approximate.
Some images in this brochure are simulated.
"SONY" is a registered trademark of Sony Corporation.
Please visit Sony's professional website or contact your Sony representative for specific models available in your region.

Sony Electronics Inc.
1 Sony Drive
Park Ridge, NJ 07656
sony.com/displays