

OLYMPUS

DIGITAL CAMERA

XZ-10

Instruction Manual

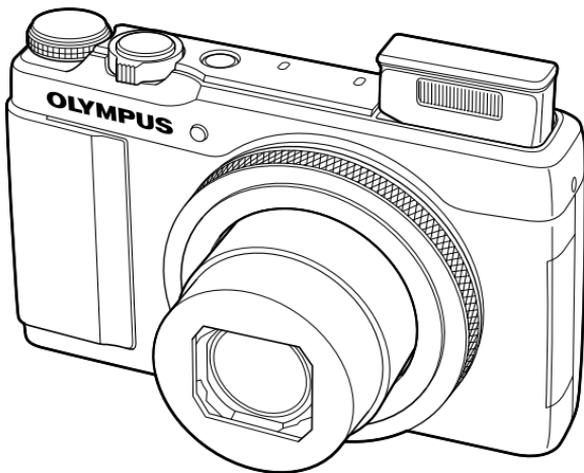

- Thank you for purchasing an Olympus digital camera. Before you start to use your new camera, please read these instructions carefully to enjoy optimum performance and a longer service life. Keep this manual in a safe place for future reference.
- We recommend that you take test shots to get accustomed to your camera before taking important photographs.
- The screen and camera illustrations shown in this manual were produced during the development stages and may differ from the actual product.
- The contents in this manual are based on firmware version 1.0 for this camera. If there are additions and/or modifications of functions due to firmware update for the camera, the contents will differ. For the latest information, please visit the Olympus website.

Names of parts

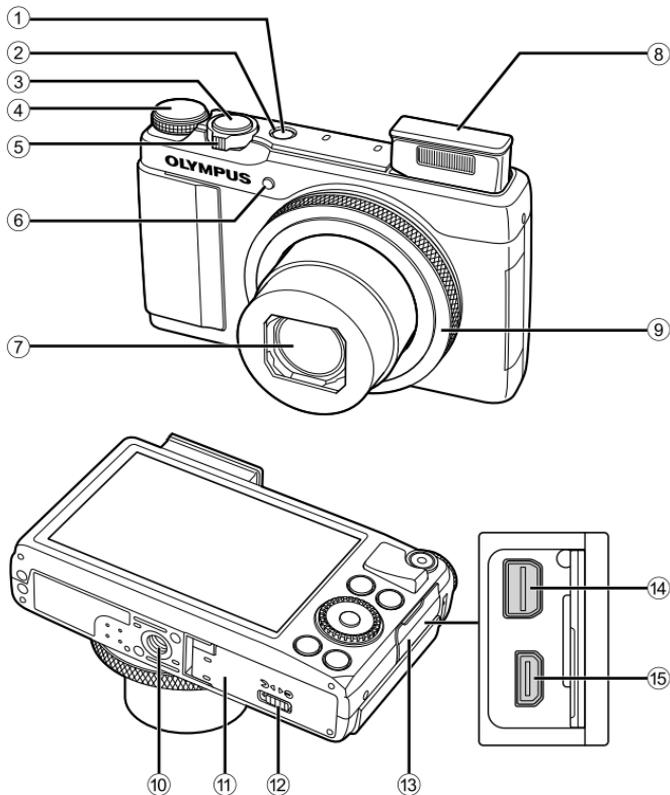

- | | |
|--|---|
| ① ON/OFF button.....P. 7 | ⑧ Built-in flash.....P. 22 |
| ② Indicator lamp.....P. 6 | ⑨ Control ring* (O).....P. 25, 77 |
| ③ Shutter button.....P. 9, 37 | ⑩ Tripod socket |
| ④ Mode dial.....P. 8 | ⑪ Battery/card compartment cover.....P. 5 |
| ⑤ Zoom lever.....P. 9, 10, 25 | ⑫ Battery/card compartment lock.....P. 5 |
| ⑥ Self-timer lamp/AF illuminator
.....P. 23/P. 51 | ⑬ Connector cover |
| ⑦ Lens | ⑭ Multi-connector.....P. 56, 60, 63 |
| | ⑮ HDMI micro connector (Type D).....P. 56 |

* In this manual, the  icon represents operations performed using the control ring.

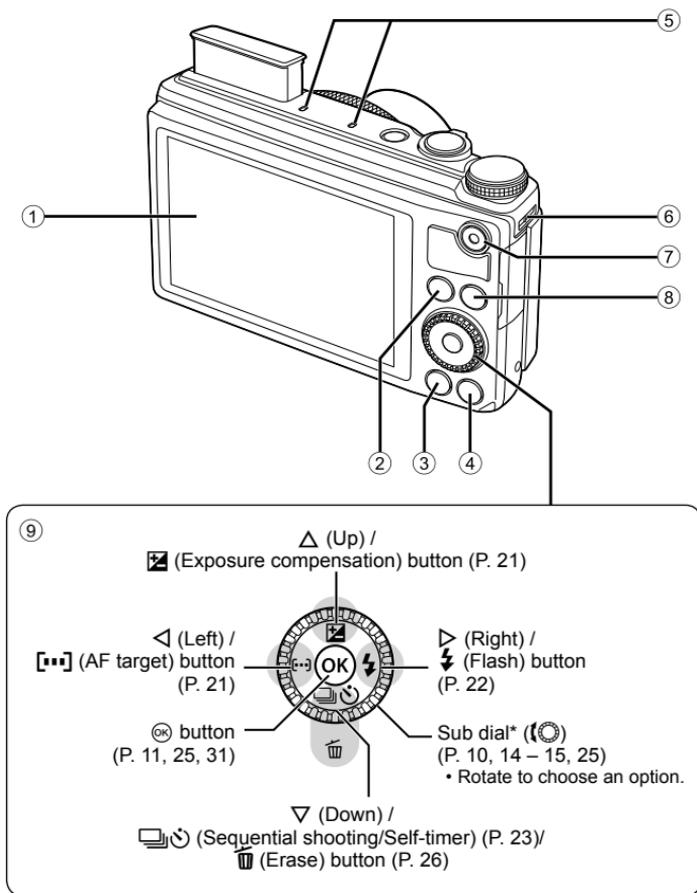

- ① Monitor (Touch screen)...P. 8, 12, 24, 29
 ② ▶ (Playback) button.....P. 10, 25
 ③ **MENU** button.....P. 39
 ④ **INFO** (Information display) button
P. 13, 24, 57

- ⑤ Stereo microphone
 ⑥ Strap eyelet.....P. 4
 ⑦ ● (Movie) button.....P. 11, 25
 ⑧ **Fn** buttonP. 25, 55
 ⑨ Arrow padP. 7

* In this manual, the Ⓞ icon represents operations performed using the sub dial.

Unpack the box contents

The following items are included with the camera.

If anything is missing or damaged, contact the dealer from whom you purchased the camera.



Camera



Strap



Stylus pen



Lithium ion battery
(LI-50B)

- Computer software CD-ROM
- Instruction manual
- Warranty card

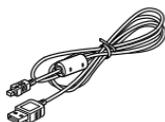

USB cable
(CB-USB8)



or



USB-AC Adapter
(F-2AC)

Attaching the camera strap

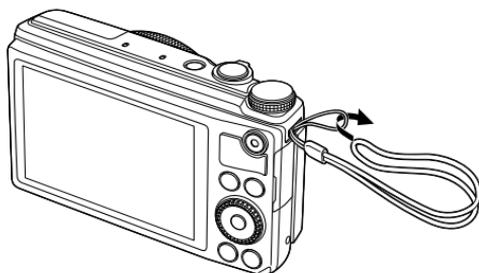

- Pull the strap tight so that it does not come loose.

Indications used in this manual

The following symbols are used throughout this manual.

 Cautions	Warns of operations that should be absolutely avoided. Also important information on factors which may lead to a malfunction or operational problems.
 Notes	Points to note when using the camera.
 Tips	Useful information and hints that will help you get the most out of your camera.
	Reference pages describing details or related information.

Inserting and removing the battery and card

- 1** Follow Steps ① and ② to open the battery/card compartment cover.
- Turn off the camera before opening the battery/card compartment cover.

Battery/card compartment cover



Battery/card compartment lock

- 2** Insert the battery while sliding the battery lock knob in the direction of the arrow.
- Insert the battery as illustrated with the ⊕ mark toward the battery lock knob. Damage to the battery exterior (scratches, etc.) may produce heat or an explosion.
 - Slide the battery lock knob in the direction of the arrow to unlock, and then remove the battery.

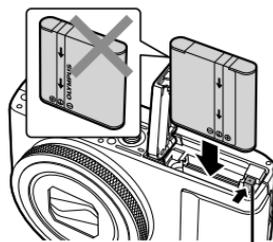

Battery lock knob

- 3** Insert the card straight until it clicks into place.
- Always use SD/SDHC/SDXC cards, Eye-Fi card or FlashAir (wireless LAN mounted) card with this camera. Do not insert other types of memory cards.  "Using the card" (P. 72)
 - Do not touch the metallic parts of the card directly.

Write-protect switch

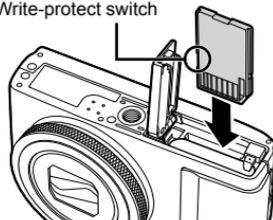

To remove the card

Press the card in until it clicks and comes out slightly, then remove the card.

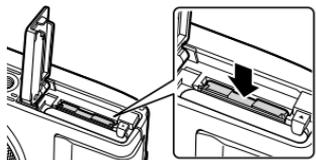

- 4** Follow Steps ① and ② to close battery/card compartment cover.
- When using the camera, be sure to close the battery/card compartment cover.



Charging the battery

Connect the USB cable and USB-AC adapter to the camera and charge the battery.

- The battery is not fully charged at shipment. Before use, be sure to charge the battery until the indicator lamp turns off (up to 3 hours).

Connecting the camera

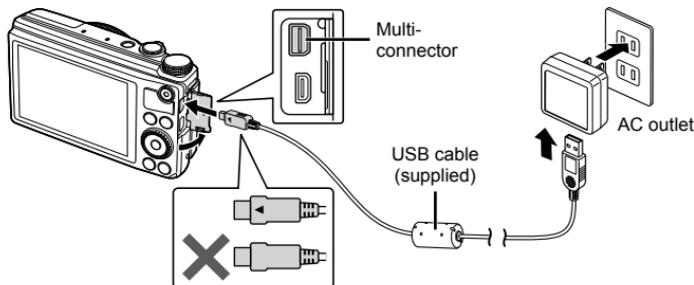

Indicator lamp

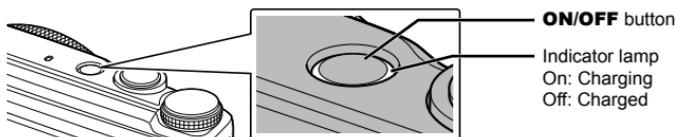

When to charge the batteries

Charge the battery when the error message shown below appears.

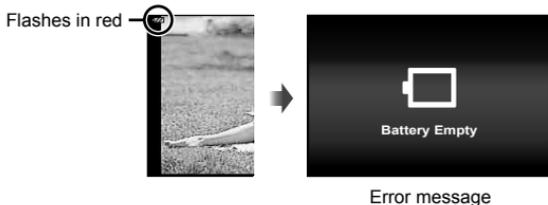

- The included F-2AC USB-AC adapter (hereafter referred to as USB-AC adapter) differs depending on the region where you purchased the camera. If you received a plug-in type USB-AC adapter, plug it directly into AC outlet.
- The included USB-AC adapter has been designed to be used for charging and playback. Do not take pictures while the AC adapter is connected to the camera.
- Be sure to unplug the power plug of the USB-AC adapter from the wall outlet when the charging is complete or the playback ends.
- For details on the battery, see "Battery Handling Precautions" (P. 82). For details on the USB-AC adapter, see "USB-AC adapter" (P. 83).
- If the indicator lamp does not light, check the USB cable and USB-AC adapter connections.
- The battery can be charged while the camera is connected to the computer via USB. The charging time varies depending on the performance of the computer. (There may be cases in which it takes approx. 10 hours.)

Turning on the camera and making the initial settings

When you turn on the camera for the first time, a screen appears enabling to set the language for the menus and messages displayed in the monitor, and the date and time.

⚠ Cautions

- Turning on the camera raises the flash. Do not place fingers on the flash.
- Selecting [⏻](Flash off) prevents the flash being raised.

📖 “Using a flash (flash photography)” (P. 22)

1 After turning the camera on with the **ON/OFF** button, select a language using $\Delta \nabla \triangleleft \triangleright$ and press the **OK** button.

2 Use $\Delta \nabla$ to select the year for [Y].



3 Press \triangleright to save the setting for [Y].



4 As in Steps 2 and 3, use $\Delta \nabla \triangleleft \triangleright$ to set [M] (month), [D] (day), [Time] (hours and minutes), and [Y/M/D] (date order), and then press the **OK** button.

- For precise time setting, press the **OK** button as the time signal strikes 00 seconds.

5 Use $\triangleleft \triangleright$ to select the [**🏠**] time zone and then press the **OK** button.

- Use $\Delta \nabla$ to turn daylight saving time ([Summer]) on or off.



Camera sleep operation

If no operations are performed for the time set, the camera enters “sleep” (stand-by) mode. In this mode, the monitor turns off and all actions are canceled. The camera activates again when you touch any button (the shutter button, **▶** button, etc.). The camera will turn off automatically if left in sleep mode for 5 minutes. Turn the camera on again before use.

Shooting

Select a shooting mode

Select a shooting mode using the mode dial.

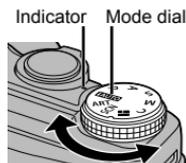

iAUTO	A full auto mode in which the camera automatically optimizes settings for the current scene. The camera does all the work, which is convenient for beginners.
P	Aperture and shutter speed are automatically adjusted for optimal results.
A	You control aperture. You can sharpen or soften background details.
S	You control shutter speed. You can express the motion of moving subjects, or freeze motion without any blur.
M	You control aperture and shutter speed. You can shoot with long exposures for fireworks or other dark scenes.
C	You can save shooting settings in advance, and then quickly call those settings when shooting.
ii	Select a theme and create a desired photo collage.
SCN	Select a scene according to the subject.
ART	Select an art filter.

Taking photographs

First, try taking photographs in full auto mode.

- 1 Set the mode dial to **iAUTO**.

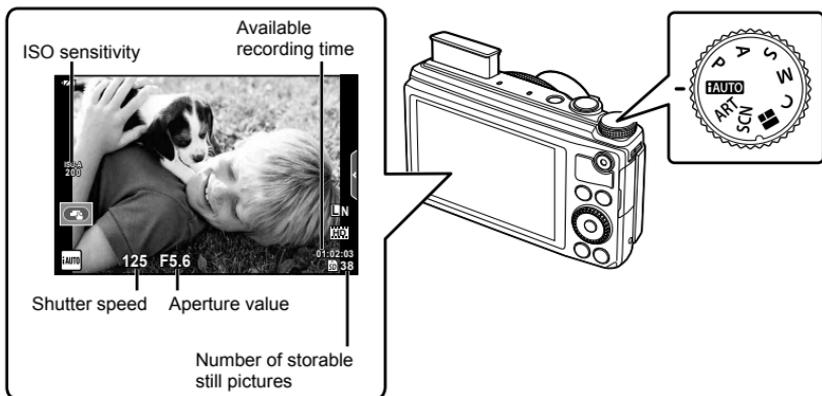

2 Frame the shot.

- When holding the camera, take care not to cover the flash, microphone or other important parts with your fingers, etc.

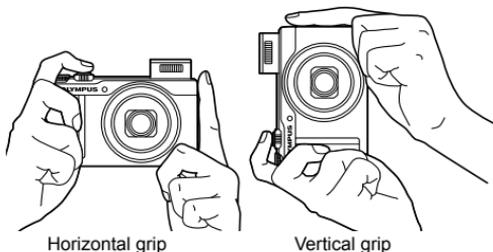

3 Adjust the focus.

- Lightly press the shutter button down to the first position (press the shutter button halfway).

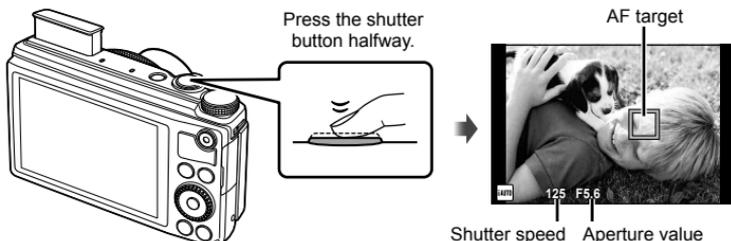

- The shutter speed and aperture value that have been set automatically by the camera are displayed.

Pressing the shutter button halfway and all the way down

The shutter button has two positions. The act of lightly pressing the shutter button to the first position and holding it there is called "pressing the shutter button halfway," that of pressing it all the way down to the second position "pressing the shutter button all (or the rest of) the way down."



4 Release the shutter.

- Press the shutter button all the way (fully).
- The shutter sounds and the picture is taken.
- The shot image will be displayed on the monitor.

Notes

- You can also take photographs using the touch screen. "Using the Touch screen" (P. 29)

Using the zoom

Turning the zoom lever adjusts the shooting range.

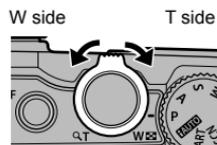

Viewing photographs

Press the  button.

- Your most recent photograph is displayed.
- Press  or turn the sub dial to select an image.

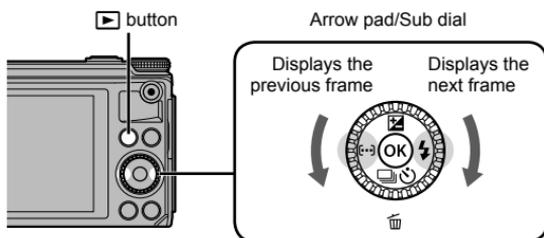

Still image

Index display

- In single-frame playback, turn the zoom lever to W for Index playback.



Close-up playback

- In single-frame playback, turn the zoom lever to T to zoom in up to 14x; turn to W to return to single-frame playback.
- You can also use the control ring to change the magnification strength.



Erasing images

Display an image you want to delete and press . Select [Yes] and press . You can also select multiple images for deletion.  "Selecting images" (P. 25)



Recording and viewing movies

1

Preparations for shooting

Recording movies

- 1 Set the mode dial to **▶AUTO**.
- 2 Press the **⊙** button to begin recording.

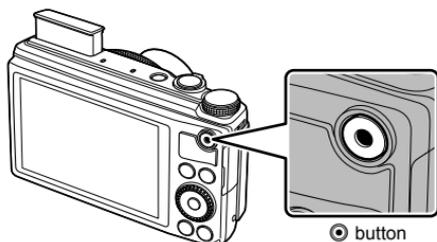

- 3 Press the **⊙** button again to end recording.



Displayed during recording

Recording time

Movie playback

Select a movie and press **OK** to display the playback menu. Select [Movie Play] and press **OK** to begin playback.

- To interrupt movie playback, press **MENU**.



Volume

Volume can be adjusted by pressing **Δ** or **∇** during single-frame and movie playback.



2 Basic photography

Basic shooting operations

Shooting

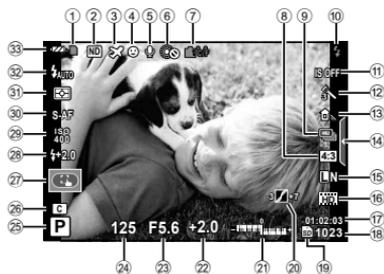

- ① Card write indicator P. 73
- ② ND Filter Setting P. 55
- ③ World Time P. 49
- ④ Face priority P. 38
- ⑤ Movie sound P. 11, 54
- ⑥ Lock P. 44
- ⑦ Internal temperature warning P. 67
- ⑧ Aspect ratio P. 34, 44
- ⑨ Sequential shooting/self-timer P. 23
- ⑩ Flash (blinks: charging in progress) P. 22
- ⑪ Image stabilizer P. 32
- ⑫ Art filter P. 16
 - Scene mode P. 17
 - Picture mode P. 32, 42
- ⑬ White balance P. 33
- ⑭ Live guide recall P. 20, 29
- ⑮ Record mode (still images) P. 34
- ⑯ Record mode (movies) P. 35
- ⑰ Available recording time
- ⑱ Number of storable still pictures P. 74
- ⑲ Current memory P. 73
- ⑳ Tone control P. 21
- ㉑ Top: Flash intensity control P. 36
 - Bottom: Exposure compensation indicator P. 21
- ㉒ Exposure compensation value P. 21
- ㉓ Aperture value P. 13–15
- ㉔ Shutter speed P. 13–15
- ㉕ Shooting mode P. 8, 13–15
- ㉖ C Mode Setup P. 41
- ㉗ Touch screen mode P. 29
- ㉘ Flash intensity control P. 36
- ㉙ ISO sensitivity P. 38
- ㉚ AF mode P. 37
- ㉛ Metering mode P. 36
- ㉜ Flash mode P. 22
- ㉝ Battery check
 -  Lit up (green) : Ready for use (displayed for about ten seconds after the camera is turned on)
 -  Lit up (green) : Battery is running low
 -  Blinks (red) : Charging required
- ㉞ Zoom bar P. 9
- ㉟ Control ring function P. 77
- ㊱ Histogram P. 13

Switching the information display

Press the **INFO** button to choose the information displayed when shooting.



Histogram display

Displays a histogram showing the distribution of brightness in the image. The horizontal axis gives the brightness, the vertical axis the number of pixels of each brightness in the image. Areas above the upper limit at shooting are displayed in red, those below the lower limit in blue, and the area metered using spot metering in green.

Using the shooting modes

“Point-and-shoot” photography (P program mode)

In mode **P**, the camera automatically adjusts shutter speed and aperture in response to subject brightness. Set the mode dial to **P**.

- The shutter speed and aperture selected by the camera are displayed in the monitor.
- The shutter speed and aperture displays flash if the camera is unable to achieve optimal exposure.

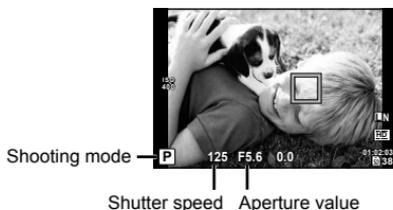

Warning display example (blinking)	Status	Action
	The subject is too dark.	Use the flash.
	The subject is too bright.	The metered range of the camera is exceeded. Set [ND Filter Setting] to [On]. "Using live control" (P. 31)

Program shift (Ps)

In **P** mode, you can use the control ring to change the combination of aperture value and shutter speed while maintaining the correct exposure. “s” appears next to the shooting mode during program shift. To cancel program shift, rotate the control ring backwards until “s” is no longer displayed.

- Program shift is not available when you are using a flash.



Choosing aperture (A aperture-priority mode)

In mode **A**, you choose the aperture and let the camera automatically adjust shutter speed for optimal exposure. Rotate the mode dial to **A**.

Lower aperture value	F2.0 ← F5.6 → F8.0	Higher aperture value
-----------------------------	--------------------	------------------------------

- You can set the aperture value with the control ring, and the exposure compensation with the sub dial.
- Larger apertures (lower F-numbers) decrease depth of field (the area in front of or behind the focus point that appears to be in focus), softening background details. Smaller apertures (higher F-numbers) increase depth of field.
- The shutter speed display will blink if the camera is unable to achieve optimal exposure.



Aperture value

Warning display example (blinking)	Status	Action
	The subject is underexposed.	Decrease the aperture value.
	The subject is overexposed.	<ul style="list-style-type: none"> Increase the aperture value. If the warning display does not disappear, the metered range of the camera is exceeded. Set [ND Filter Setting] to [On]. "Using live control" (P. 31)

Choosing shutter speed (S shutter-priority mode)

In mode **S**, you choose the shutter speed and let the camera automatically adjust aperture for optimal exposure. Rotate the mode dial to **S**.

Slower shutter speed	2" ← 1" ← 15 ← 60 → 100 → 400 → 1000	Faster shutter speed
-----------------------------	--------------------------------------	-----------------------------

- You can set the shutter speed with the control ring, and the exposure compensation with the sub dial.
- A fast shutter speed can freeze a fast action scene without any blur. A slow shutter speed will blur a fast action scene. This blurring will give the impression of dynamic motion.
- The aperture value display will blink if the camera is unable to achieve optimal exposure.



Shutter speed

Warning display example (blinking)	Status	Action
	The subject is underexposed.	Set the shutter speed slower.
	The subject is overexposed.	<ul style="list-style-type: none"> • Set the shutter speed faster. • If the warning display does not disappear, the metered range of the camera is exceeded. Set [ND Filter Setting] to [On]. "Using live control" (P. 31)

Choosing aperture and shutter speed (M manual mode)

In mode **M**, you choose both the aperture and the shutter speed. Set the mode dial to **M**, and set the shutter speed with the control ring, and the aperture value with the sub dial.

- The shutter speed can be set to 1/2000–30 sec.
- You can change the functions assigned to the control ring and the sub dial. [Dial Function] (P. 51)

Cautions

- Exposure compensation is not available in **M** mode.

Noise in images

While shooting at slow shutter speeds, noise may appear on-screen. These phenomena are caused when current is generated in those sections of the image pickup device that are not normally exposed to light, resulting in a rise in temperature in the image pickup device or image pickup device drive circuit. This can also occur when shooting with a high ISO setting in a high-temperature environment. To reduce this noise, the camera activates the noise reduction function. [Noise Reduct.] (P. 52)

Using art filters

1 Rotate the mode dial to **ART**.

- A menu of art filters will be displayed. Referring to samples displayed, select a filter using Δ ∇ and press \odot .

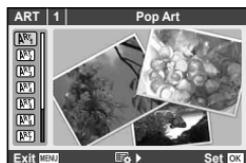

Types of art filters

Pop Art	Diorama
Soft Focus	Cross Process
Pale&Light Color	Gentle Sepia
Light Tone	Dramatic Tone
Grainy Film	Key Line
Pin Hole	

2 Shoot.

- To choose a different setting, press \odot to display the art filter menu.

Art effects

Art filters can be modified and effects can be added. Pressing \triangleright in the art filter menu displays additional options.

Modifying filters

Option I is the original filter, while options II and on add effects that modify the original filter.

Adding effects *

Soft focus, pin-hole, white edges, frames, starlight

* The effects available vary with the selected filter.

! Cautions

- If [RAW] is currently selected for image quality, image quality will automatically be set to [I/N+RAW]. The art filter will be applied to the JPEG copy only.
- Depending on the subject, tone transitions may be ragged, the effect may be less noticeable, or the image may become more "grainy."
- Some effects may not be visible in live view or during movie recording.
- Playback may differ according to the filters, effects, or movie quality settings applied.

Shooting in scene mode

1 Rotate the mode dial to **SCN**.

- A menu of scene menu will be displayed. Referring to explanations and samples displayed, select a scene mode using Δ ∇ and press \odot .
- Press \odot or press the shutter button halfway to change to the live view display. Press \odot to go back to the scene menu display.



Types of scene modes

Portrait	Sunset
e-Portrait	Documents
Landscape	Panorama (P. 17)
Sport	Fireworks
Hand-Held Starlight	Multi. Exposure
Night Scene	Beach & Snow
Night+Portrait	Backlight HDR

2 Shoot.

- To choose a different setting, press \odot to display the scene menu.

! Cautions

- In [e-Portrait] mode, two images are recorded: an unmodified image and a second image to which [e-Portrait] effects have been applied. The unmodified image is recorded using the option currently selected for image quality, the modified copy at an image quality of JPEG (M-quality (2560 × 1920)).
- Effects of some scene modes are not applied in recording movies.

■ Taking pictures for a panorama

If you have installed the supplied computer software, you can use it to join pictures together to form a panorama. "Installing Software" (P. 63)

1 Rotate the mode dial to **SCN**.

2 Select [Panorama] and press \odot .

3 Use Δ ∇ \triangleleft \triangleright to choose a pan direction.

4 Take a picture, using the guides to frame the shot.

- Focus, exposure, and other settings are fixed at the values for the first shot.



- 5 Take the remaining images, framing each shot so that the guides overlap with the previous picture.

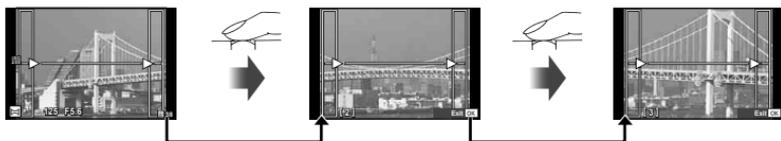

- A panorama may include up to 10 images. A warning indicator (ⓘ) is displayed after the tenth shot.

- 6 After taking the last shot, press **OK** to end the series.

⚠ Cautions

- During panorama shooting, the image previously taken for position alignment will not be displayed. With the frames or other markers for display in the images as a guide, set the composition such that the edges of the overlapping images overlap within the frames.

📝 Notes

- Pressing **OK** before shooting the first frame returns to the scene mode selection menu. Pressing **OK** in the midst of shooting ends the sequence of panorama shooting, and allows you to continue with the next one.

Creating collages

When shooting, an image is incorporated into a layout frame set to create a desired collage. This enables wide range of photo expression with themes or stories. Tapping to shoot is also available.

- 1 Rotate the mode dial to **COLLAGE**.

- A menu will be displayed.

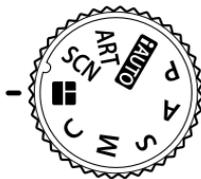

- 2 Select a theme using **△**/**▽** and press **▷**.

Types of theme

- 1** Standard
- 2** Speed
- 3** Zoom In/Out
- 4** Fun Frames

Theme



- 3 Select desired items in the theme using $\Delta \nabla \triangleleft \triangleright$, then press \triangleright .

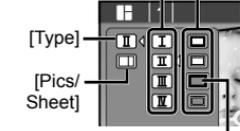
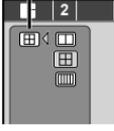
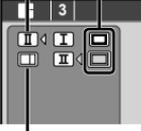

 Standard	 Speed	 Zoom In/Out	 Fun Frame
Sub-menus of [Type] [Effect]  Current item	[Pics/Sheet] 	[Type] [Effect]  [Pics/Sheet]	[Effect] 

- 4 Tap a frame in standby mode to shoot.
- To shoot another frame, tap the desired frame.



- To delete a framed image, tap the frame then tap \square .
- Shootings can be terminated in the middle to restart shooting from the first frame. Press the **MENU** button and select [Save] to save the picture then restart shooting. Press the **MENU** button and select [Exit] not to save the picture and restart shooting again.
- Pressing the \triangleright button ends shooting and displays the playback. In this case, the picture is not saved.

- 5 After shooting all frames, press \odot **OK** and save the picture.

Cautions

- When changing a shooting mode in the middle of shooting, the picture will not be saved.
- An image is saved as one photo collage, and each framed image is not saved as an image.
- Image size is fixed to 5M.

Using shooting options

Using live guides

- 1 Set the mode dial to **FAUTO**.
- 2 After pressing **OK** to display the live guide, use the **Δ**/**∇** buttons on the arrow pad to highlight an item and press **OK** to select.



- 3 Use **Δ**/**∇** on the arrow pad to choose the level.
 - If [Shooting Tips] is selected, highlight an item and press **OK** to view a description.
 - Press the shutter button halfway or press **OK** to save the setting.
 - The effect of the selected level is visible in the display. If [Blur Background] or [Express Motions] is selected, the display will return to normal, but the selected effect will be visible in the final photograph.

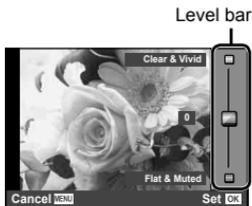

- 4 Shoot.
 - Press the shutter button to shoot.
 - To clear the live guide from the display, press the **MENU** button.

! Cautions

- If [RAW] is currently selected for image quality, image quality will automatically be set to [L+N+RAW].
- Live guide settings other than [Blur Background] and [Express Motions] are not applied to the RAW copy.
- [Blur Background] and [Express Motions] settings are not applied to movie recording.
- Pictures may appear grainy at some live guide setting levels.
- Changes to live guide setting levels may not be visible in the monitor.
- The flash can not be used with the live guide.
- Changes to live guide options cancel previous changes.
- Choosing live guide settings that exceed the limits of the camera exposure meters may result in pictures that are over- or under-exposed.

💡 Tips

- In modes other than **FAUTO**, you can use live control to make more detailed settings.
 - "Using live control" (P. 31)

Controlling exposure (exposure compensation)

Press the  button (Δ) and rotate the sub dial to adjust exposure. Choose positive (“+”) values to make pictures brighter, negative (“-”) values to make pictures darker. Exposure can be adjusted in the range of $\pm 3\text{EV}$.



Cautions

- Exposure compensation is not available in **FAUTO**, **M**, or **SCN** (except partially) modes.

Changing the brightness of highlights and shadows

To display the tone control dialog, press the  button (Δ) and press the **INFO** button. Use $\langle \rangle$ to choose a tone level. Choose “low” to darken shadows or “high” to brighten highlights.

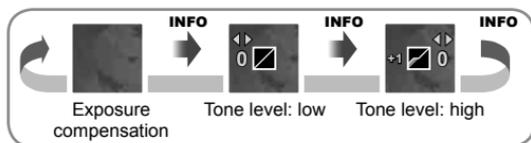

Choosing a focus target (AF target)

Choose which of the 35 autofocus targets will be used for autofocus.

- Press the  button ($\langle \rangle$) to display the AF target.
- Use $\Delta \nabla \langle \rangle$ to select the single target display and position the AF target.
 - “All targets” mode is restored if you move the cursor off the screen.

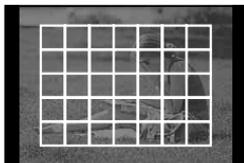

All Targets

The camera automatically chooses from the full set of focus targets.

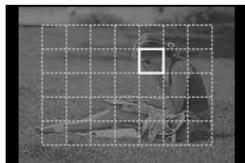

Single Target

Select the focus target manually.

Using a flash (flash photography)

1 Press the  button () to display options.

2 Use   to choose a flash mode and press .

- When the flash is lowered and closed by hand, the camera selects  (Flash off). When using flash, press the  button () and change a flash mode.

	Auto flash	The flash fires automatically in low light or backlight conditions.
	Red-eye reduction flash	This function allows you to reduce the red-eye phenomenon.
	Fill-in flash	The flash fires regardless of the light conditions.
	Flash off	The flash does not fire.
 *1 SLOW	Slow synchronization/ Red-eye reduction flash	Combines slow synchronization with red-eye reduction.
 RC*2	Remote Control	An Olympus Wireless RC Flash System compatible flash is used for taking pictures.
 SLV*2	Slave	The commercially-available slave flash that is synchronized with the camera flash is used for taking pictures. The flash intensity setting can be adjusted.
 SLOW*1	Slow synchronization	Slow shutter speeds are used to brighten dimly-lit backgrounds.
 FULL,  1/4, etc.	Manual	For users who prefer manual operation.

*1 Mode **P** and **A** only.

*2 Wireless flash photography is available only when [Remote Flash] (P. 75) is selected.

3 Press the shutter button all the way.

Cautions

- In [] (Red-eye reduction flash), after the pre-flashes, it takes about 1 second before the shutter is released. Do not move the camera until shooting is complete.
- [] (Red-eye reduction flash) may not work effectively under some shooting conditions.
- **AUTO**,  can be set in **AUTO** mode.

Minimum Flash Range

The lens may cast shadows over objects close to the camera, causing vignetting, or be too bright even at minimum output.

- To prevent photographs from being overexposed, select mode **A** or **M** and choose a high f-number, or reduce ISO sensitivity.

Sequential shooting/using the self timer

The camera will take sequential photos while the shutter button is pressed all the way down. Alternatively, the self-timer can be used for self- or group-portraits or to reduce camera shake when the camera is mounted on a tripod or otherwise fixed in place.

- 1 Press the  button (∇) to display the direct menu.
- 2 Select an option using \triangleleft and \triangleright and press .

 Single-frame shooting	Shoots 1 frame at a time when the shutter button is pressed (normal shooting mode).
 Sequential shooting	Photographs are taken at about 5 frames per second (fps) while the shutter button is pressed all the way down.
 High-Speed	Photographs are taken at about 15 frames per second (fps) while the shutter button is pressed all the way down. Available only if [S\](Natural) is selected for [Picture Mode].
BKT BKT	While the shutter button is pressed all the way down, photographs are taken with automatically changing the settings for each frame (bracket photography).
 Self-timer 12 SEC	Press the shutter button halfway to focus, the rest of the way down to start the timer. First, the self-timer lamp lights up for approximately 10 seconds, then it blinks for approximately 2 seconds and the picture is taken.
 Self-timer 2 SEC	Press the shutter button halfway to focus, the rest of the way down to start the timer. The self-timer lamp blinks for approximately 2 seconds, and then the picture is taken.

Notes

- To cancel the activated self-timer, press the  button.
- During sequential shooting, focus, exposure, and white balance are locked at the first frame.
- Bracketing is available only when [Bracketing] (P. 44) is selected.

Cautions

- During sequential shooting, if the battery check blinks due to low battery, the camera stops shooting and starts saving the pictures you have taken on the card. The camera may not save all of the pictures depending on how much battery power remains.
- Fix the camera securely on a tripod for self-timer shooting.
- If you stand in front of the camera to press the shutter button halfway when using the self-timer, the photograph may be out of focus.

Basic playback operations

Monitor display during playback

Simplified display

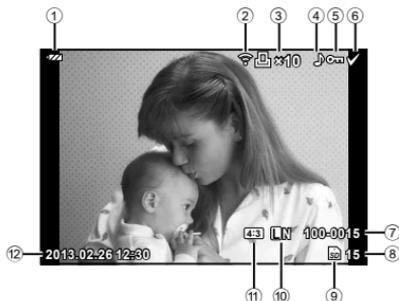

Overall display

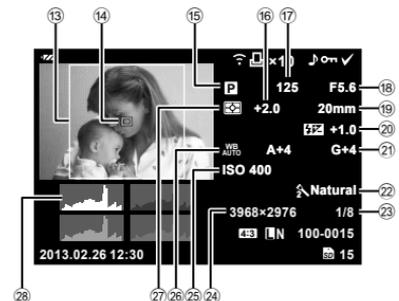

2

Basic photography

- ① Battery checkP. 6
- ② Eye-Fi upload completeP. 54
- ③ Print reservation
Number of printsP. 59
- ④ Sound recordP. 27
- ⑤ ProtectP. 26
- ⑥ Image selectedP. 25
- ⑦ File numberP. 53
- ⑧ Frame number
- ⑨ Storage deviceP. 73
- ⑩ Record modeP. 34
- ⑪ Aspect ratioP. 34, 44, 46
- ⑫ Date and timeP. 7, 49
- ⑬ Aspect borderP. 34, 44, 46
- ⑭ AF targetP. 21

- ⑮ Shooting modeP. 8, 13–15
- ⑯ Exposure compensationP. 21
- ⑰ Shutter speedP. 13–15
- ⑱ Aperture valueP. 13–15
- ⑲ Focal lengthP. 9
- ⑳ Flash intensity controlP. 36
- ㉑ White balance compensationP. 33
- ㉒ Picture modeP. 32, 42
- ㉓ Compression rateP. 34–35, 53, 74
- ㉔ Pixel countP. 34–35, 53, 74
- ㉕ ISO sensitivityP. 38
- ㉖ White balanceP. 33
- ㉗ Metering modeP. 36
- ㉘ HistogramP. 13

Displaying information during playback

The **INFO** button can be used to choose the information displayed during playback.



Playback options

Press the  button to view pictures full frame. To exit to shooting mode, press the shutter button halfway.

Index display



Single-frame playback



Index display

Playback zoom (close-up playback)



Single-frame playback



Close-up playback

Sub dial ()	Previous () / next ()
Arrow pad (   )	Single frame playback: next () / previous () close-up playback: move the position of close-up index playback: selecting images
INFO	Displays the information of the image
 (Movie button)	Selecting images
 ()	Erasing images
	Menu display
Control ring ()	Zooming in/out
Fn	Protecting images

■ Selecting images

Select multiple pictures for protection or deletion. Press the  button to select the current picture. Selected pictures are marked with . To remove  and deselect the picture, press the  button again.



■ Erasing selected images

Press ∇ (🗑️), select [Yes], then press \odot (OK) to erase selected images.



■ Protecting images

Protect images from accidental deletion. Display an image you wish to protect and press the **Fn** button; a **On** (protect) icon will appear on the image. Press the **Fn** button again to remove protection.

You can also protect multiple selected images. After selecting images in "Selecting images" (P. 25), press the **Fn** button.



⚠️ Cautions

- Formatting the card erases all images even if they have been protected.

Using playback options

Press \odot (OK) during playback to display a menu of simple options that can be used in playback mode.



	Still image frame			Movie frame
	RAW	JPEG	RAW+JPEG	
JPEG Edit (P. 46)	—	✓	✓	—
RAW Data Edit (P. 46)	✓	—	✓	—
Movie Play	—	—	—	✓
Audio playback	✓	✓	✓	—
On (Protect)	✓	✓	✓	✓
🎤 (Audio recording)	✓	✓	✓	—
Rotate	✓	✓	✓	—
Slideshow	✓	✓	✓	✓
🖨️ (Print reservation)	—	✓	✓	—
Erase	✓	✓	✓	✓

■ Performing operations on a movie frame (Movie Play)

OK	Pause or resume playback.	
	• You can perform the following operations while playback is paused.	
	◀▶ or Sub dial	Previous/Next Press and hold ◀▶ to continue the operation.
	▲	Display the first frame.
	▼	Display the last frame.
◀▶	Advance or rewind a movie.	
▲/▼	Adjust volume.	

! Cautions

- We recommend using the supplied PC software to play movies on a computer. Before launching the software for the first time, connect the camera to the computer.

■ Audio recording

Add an audio recording (up to 4 sec. long) to the current photograph.

1 Display the image to which you want to add an audio recording and press OK.

- Audio recording is not available with protected images.
- Audio recording is also available in the playback menu.

2 Select [M] and press OK.

- To exit without adding a recording, select [No].



3 Select [M Start] and press OK to begin recording.

- To stop recording part-way through, press OK.



4 Press OK to end recording.

- Images with audio recordings are indicated by a M icon.
- To delete a recording, select [Erase] in Step 2.

■ Rotate

Choose whether to rotate photographs.

- 1 Play the photograph back and press **OK**.
- 2 Select [Rotate] and press **OK**.
- 3 Press **△** to rotate the image counterclockwise, **▽** to rotate it clockwise; the image rotates each time the button is pressed.
 - Press **OK** to save settings and exit.
 - The rotated image is saved in its current orientation.
 - Movies and protected images can not be rotated.

■ Slideshow

This function displays images stored on the card one after another.

- 1 Press **OK** during playback and select the slideshow option.



- 2 Adjust settings.

Start	Start the slideshow. Images are displayed in order, starting with the current picture.
BGM	Set BGM (5 types) or turn BGM [Off].
Effect	Choose the transition between frames.
Slide	Set type of slideshow to execute.
Slide Interval	Choose the length of time each slide is displayed from 2 to 10 seconds.
Movie Interval	Select [Full] to include full-length movie clips in the slideshow, [Short] to include only the opening portion of each clip.

- 3 Select [Start] and press **OK**.
 - The slideshow will start.
 - Press **OK** to stop the slideshow.

Using the Touch screen

The monitor acts as a touch screen to control the camera.

Live Guides

The touch screen can be used with live guides.

- 1 Touch the tab and swipe your finger to the left to display live guides.
 - Tap to select items.
- 2 Use your finger to position the sliders.
 - Press the **MENU** button to exit the live guide display.



Shooting Mode

You can focus and shoot by tapping the monitor.

Tap  to cycle through touch screen settings.

	Touch screen operations disabled.
	Tap a subject to focus. Photographs can be taken by pressing the shutter button.
	Tap a subject to focus and automatically release the shutter.

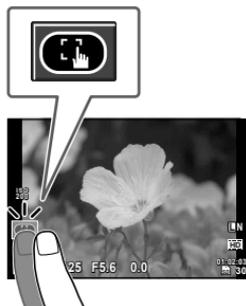

Playback Mode

Use the touch screen to page through images or zoom in and out.

■ Full-Frame Playback

Viewing Additional Images

- Slide your finger to the left to view later frames, right to scroll through earlier frames.
- Keep touching the left side of the screen to continuously view earlier frames, right to view later frames.

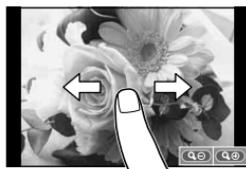

Playback Zoom

- Tap  to enlarge the screen. Tap  repeatedly to return to single-frame playback.
- Use your finger to scroll the display when the picture is zoomed in.



■ Index Playback

Tap  to display Index playback.

Page Ahead/Page Back

- Slide your finger up to view the next page, down to view the previous page.
- Use  or  to choose the number of images displayed.
- For single-frame playback, tap  until the current image is displayed full frame.

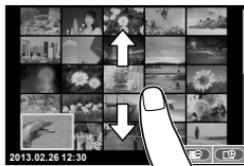

Viewing Images

- Tap an image to view it full frame.



Tips

- Disabling the touch screen.  [Touch Screen Settings] (P. 54)

3 Frequently-used options

Using live control

The live control can be used to adjust settings in **P**, **S**, **A** and **M** modes. Using live control allows you to preview the effects of different settings in the monitor.



Available settings

Image stabilizer	P. 32	Flash intensity control	P. 36
Picture mode	P. 32, 42	Metering mode	P. 36
White balance	P. 33	AF mode	P. 37
Sequential shooting/self-timer	P. 23	ISO sensitivity	P. 38
Aspect Ratio	P. 34, 44, 46	Face priority	P. 36, 38
Record mode	P. 34	ND Filter Setting	
Flash mode	P. 22		

- 1 Press **OK** to display the live control.
 - To hide the live control, press **OK** again.
- 2 Use **Δ**/**∇** on the arrow pad to select settings, use **◀**/**▶** to change the selected setting, and press **OK**.
 - The selected settings take effect automatically if no operations are performed for about 8 seconds.

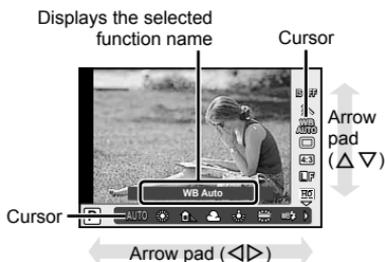

! Cautions

- Some items are not available in some shooting modes.

💡 Tips

- For more advanced options or to customize your camera, use the menus to make settings.
 - ▶ "Using the menus" (P. 39)

Reducing camera shake (Image Stabilizer)

Select [ON] to reduce camera shake that can occur when shooting in low light situations or shooting with high magnification.

1 Display the live control and select the image stabilizer item using $\Delta \nabla$.

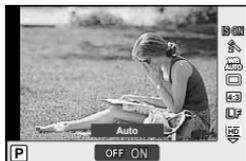

2 Select [ON] with $\triangleleft \triangleright$ and press \odot .

! Cautions

- The image stabilizer cannot correct excessive camera shake or camera shake that occurs when the shutter speed is set to the slowest speed. In these cases, it is recommended that you use a tripod.
- When using a tripod, set [Image Stabilizer] to [Off].

Processing options (Picture Mode)

Select a picture mode.

1 Display the live control and select the Picture Mode item using $\Delta \nabla$.



2 Select an option with $\triangleleft \triangleright$ and press \odot .

Vivid	Produces vivid colors.
Natural	Produces natural colors.
Muted	Produces flat tones.
Portrait	Produces beautiful skin tones.
Monotone	Produces black and white tone.
Pop Art	Choose an art filter and select the desired effect.
Soft Focus	
Pale&Light Color	
Light Tone	
Grainy Film	
Pin Hole	
Diorama	
Cross Process	
Gentle Sepia	
Dramatic Tone	
Key Line	

Adjusting color (White Balance)

White balance (WB) ensures that white objects in images recorded by the camera appear white. [AUTO] is suitable in most circumstances, but other values can be selected according to the light source when [AUTO] fails to produce the desired results or you wish to introduce a deliberate color cast into your images.

- 1 Display the live control and select the white balance item using $\Delta \nabla$.



- 2 Select an option using $\triangleleft \triangleright$ and press OK .

WB mode		Color temperature	Light conditions
Auto white balance	AUTO	—	Used for most light conditions (when there is a white portion framed on the monitor). Use this mode for general use.
Preset white balance		5300K	For shooting outdoors on a clear day, or to capture the reds in a sunset or the colors in a fireworks display
		7500K	For shooting outdoors in the shadows on a clear day
		6000K	For shooting outdoors on a cloudy day
		3000K	For shooting under a tungsten light
		4000K	For subjects lit by fluorescent lights
		5500K	For flash shooting
One-touch white balance		Color temperature set by one-touch WB.	Choose when a white or gray subject can be used to measure white balance and the subject is under mixed lighting or lit by an unknown type of flash or other light source.
Custom white balance	CWB	2000K – 14000K	After pressing the INFO button, use $\triangleleft \triangleright$ buttons to select a color temperature and then press OK .

One-touch white balance

Measure white balance by framing a piece of paper or other white object under the lighting that will be used in the final photograph. This is useful when shooting a subject under natural light, as well as under various light sources with different color temperatures.

- 1 Choose or .
- 2 Point the camera at a colorless sheet of paper (such as white or gray), and then press the **INFO** button.
 - Frame the object so that it fills the display and no shadows fall it.
 - The one-touch white balance screen appears.

3 Select [Yes] and press \odot .

- The new value is saved as a preset white balance option.
- The new value is stored until one-touch white balance is recorded again. Turning the power off does not erase the data.



Tips

- If the subject is too bright or too dark or visibly tinted, the message [WB NG Retry] will be displayed and no value will be recorded. Correct the problem and repeat the process from Step 1.

Setting the image aspect (Image Aspect)

You can change the aspect ratio (horizontal-to-vertical ratio) when taking pictures. Depending on your preference, you can set the aspect ratio to [4:3] (standard), [16:9], [3:2] or [1:1].

1 Display the live control and select the aspect ratio item using $\Delta \nabla$.

2 Use $\triangleleft \triangleright$ to select an aspect ratio and press \odot .

! Cautions

- JPEG images are cropped to the selected aspect ratio; RAW images, however, are not cropped but are instead saved with information on the selected aspect ratio.
- When RAW images are played back, the selected aspect ratio is shown by a frame.

Image quality (Record Mode)

Select an image quality for photographs and movies according their intended use, for example retouching on a computer or display on the web.

1 Display the live control and use $\Delta \nabla$ to choose a record mode for photographs or movies.

2 Select an option using $\triangleleft \triangleright$ and press \odot .



Record mode

■ Record modes (still images)

Choose from RAW and JPEG (F, N, M, and S) modes. Choose a RAW+JPEG option to record both a RAW and a JPEG image with each shot. JPEG modes combine image size (L, M, and S) and compression ratio (SF, F, N, and B). The options available can be selected using the [Set] option in the custom menus.

Image size		Compression rate				Application
Name	Pixel count	SF (Super Fine)	F (Fine)	N (Normal)	B (Basic)	
L (Large)	3968 × 2976*	L SF	L F*	L N*	L B	Select for the print size
M (Middle)	3200 × 2400	M SF	M F	M N*	M B	
	2560 × 1920*					
	1920 × 1440					
1600 × 1200						
S (Small)	1280 × 960*	S SF	S F	S N*	S B	For small prints and use on a website
	1024 × 768					
	640 × 480					

* Default

RAW image data

This format (extension ".ORF") stores unprocessed image data for later processing. RAW image data cannot be viewed using other cameras or software, and RAW images cannot be selected for printing. JPEG copies of RAW images can be created using this camera.

 "Editing still images (Edit)" (P. 46)

■ Record modes (movies)

Record mode	Pixel count	Frame rate	Recording length
Full HD	1920 × 1080	30 fps	29 min
HD	1280 × 720	30 fps	
HS120*	1280 × 720	120 fps	20 sec
HS240*	432 × 324	240 fps	

* HS: Record quickly moving subjects for slow-motion playback. Available in **P** mode.

Cautions

- Individual files can be up to 4 GB in size.
- Depending on the type of card used, recording may end before the maximum length is reached.

Adjusting flash output (Flash Intensity Control)

Flash output can be adjusted if you find that your subject to appears overexposed, or is underexposed even though the exposure in the rest of the frame is just right.

- 1 Display the live control and select the Flash intensity control item using $\Delta \nabla$.



- 2 Choose the compensation value with $\triangleleft \triangleright$ and press OK .

Choosing how the camera measures brightness (Metering)

Choose how the camera meters subject brightness.

- 1 Display the live control and select the metering item using $\Delta \nabla$.



- 2 Select an option with $\triangleleft \triangleright$ and press OK .

 ESP metering	The camera optimizes exposure for the current scene or (if an option other than [Off] is selected for [Face Priority]) portrait subject. This mode is recommended for general use.
 Center weighted averaging metering	This metering mode provides the average metering between the subject and the background lighting, placing more weight on the subject at the center. 
 Spot metering	Choose this option to meter a small area with the camera pointed at the object you wish to meter. Exposure will be adjusted according to the brightness at the metered point. 

- 3 Press the shutter button halfway.
 - Normally, the camera will start metering when the shutter button is pressed halfway and lock exposure while the shutter button is held in this position.

Choosing a focus mode (AF Mode)

Select a focusing method (focus mode).

- 1 Display the live control and select the AF mode item using Δ ∇ .
 - 2 Select an option with \triangleleft \triangleright and press OK .
 - The selected AF mode is displayed on the monitor.



S-AF (single AF)	The camera focuses once when the shutter button is pressed halfway. When the focus is locked, a beep sounds, and the AF target mark light up.
Super Macro	You can focus from 1 cm away from the subject.

! Cautions

- The flash (P. 22) and zoom (P. 9) are unavailable during super macro photography. The zoom is automatically adjusted.
- The camera may be unable to focus if the subject is poorly lit, obscured by mist or smoke, or lacks contrast.

■ Focus lock

If the camera is unable to focus on your chosen subject, select single target mode and use focus lock to focus on another subject at about the same distance.

- 1 In [S-AF] mode, position the AF target over the subject and press the shutter button halfway.
 - Check that the AF target mark has turned green.
 - Focus locks while the shutter button is pressed halfway.
- 2 Keeping the shutter button pressed halfway, recompose the photograph and then press the shutter button the rest of the way down.
 - Do not change the distance between the camera and the subject while pressing the shutter button halfway.

ISO sensitivity (ISO)

Increasing ISO sensitivity increases noise (graininess) but allows photographs to be taken when lighting is poor. The setting recommended in most situations is [AUTO], which adjusts ISO sensitivity according to shooting conditions.

- 1 Display the live control and select the ISO sensitivity item using $\Delta \nabla$.
- 2 Select an option using $\triangleleft \triangleright$ and press \odot .

AUTO	The sensitivity is set automatically according to the shooting conditions.
100–6400	Sensitivity is set to the selected value.

Face priority AF (☺ Face Priority)

The camera detects faces and adjusts focus and ESP metering.

- 1 Display the live control and select the face priority item using $\Delta \nabla$.
- 2 Select [☺](Face Priority On) with $\triangleleft \triangleright$ and press \odot .



- 3 Point the camera at your subject.
 - If a face is detected, it will be indicated by a white border.
- 4 Press the shutter button halfway to focus.
 - When the camera focuses on the face in the white border, the border will turn green.



- 5 Press the shutter button the rest of the way down to shoot.

! Cautions

- Face priority applies only to the first shot in each sequence taken during sequential shooting.
- Depending on the subject, the camera may not be able to correctly detect the face.
- In metering modes other than [ESP](ESP metering), the camera will meter exposure for the selected position.

Using the menus

The menus contain shooting, playback, and other useful options and let you customize the camera settings for easier use.

Shooting Menu 1 (P. 40)	Preliminary and basic shooting options
Shooting Menu 2 (P. 40)	Advanced shooting options
Playback Menu (P. 46)	Playback and retouch options
Custom Menu (P. 50)	Customizing camera settings
Setup Menu (P. 49)	Camera setup (e.g., date and language)

1 Press the **MENU** button to display the menus.

2 Use Δ / ∇ to select a tab and press \odot .

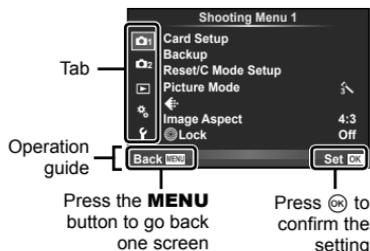

3 Select an item using Δ / ∇ and press \odot to display options for the selected item.

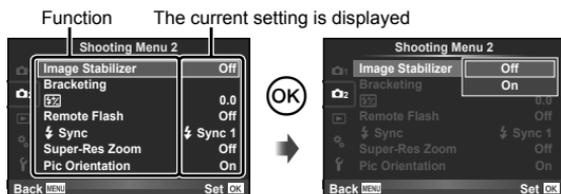

4 Use Δ / ∇ to highlight an option and press \odot to select.
• Press the **MENU** button repeatedly to exit the menu.

Notes

- For details on the functions that can be set with the menu, refer to "Menu directory" (P. 76).
- A guide is displayed for about 2 seconds after you select an option. Press the **INFO** button to view or hide guides.

📷₁ Shooting Menu 1 / 📷₂ Shooting Menu 2



📷₁ Shooting Menu 1

- Card Setup/Memory Setup (P. 40)
- Backup (P. 40)
- Reset/C Mode Setup (P. 41)
- Picture Mode (P. 42)
- ◀ (P. 43)
- Image Aspect (P. 44)
- ⊙ Lock (P. 44)

📷₂ Shooting Menu 2

- Image Stabilizer (P. 32)
- Bracketing (P. 44)
- 📷 (P. 36)
- Remote Flash (P. 45)
- ⚡ Sync (P. 45)
- Super-Res Zoom (P. 45)
- Pic Orientation (P. 45)

Erasing data completely (Card Setup/Memory Setup)

All data stored on the card, including protected images, is erased when the card is formatted.

Confirm there are no images that you still want to keep on the memory.

- Cards formatted on a computer or other camera must be formatted with the camera before they can be used.
- Be sure to remove the card before formatting the internal memory.

- 1 Select [Card Setup] in 📷₁ shooting menu 1.
- 2 Select [Format].
- 3 Select [Yes] and press **OK**.
 - Formatting is performed.



Copying images in the internal memory to the card (Backup)

Backs up image data in the internal memory to the card.

- 1 Select [Backup] in 📷₁ shooting menu 1.
- 2 Select [Yes].
 - To cancel [Backup], select [No].

Restoring default or custom settings (Reset/C Mode Setup)

Restore default settings.

- 1 Select [Reset/C Mode Setup] in  shooting menu 1.
- 2 Select [Reset] and press .
 - Highlight [Reset] and press  to choose the reset type. To reset all settings except the date, language, and a few others, highlight [Full] and press .
 -  “Menu directory” (P. 76)
- 3 Select [Yes] and press .



Registering a custom setting (Reset/C Mode Setup)

Restore preselected settings for **P**, **A**, **S** or **M** mode.

- 1 Adjust settings in order to save.
- 2 Select [Reset/C Mode Setup] in  shooting menu 1.
- 3 Select [Custom Mode] and press .
- 4 Select [Set] and press .
 - To erase the registered setting, select [Reset] and press .
 - Functions that can be saved to [C Mode Setup].  “Menu directory” (P. 76)

■ Calling the settings registered

Set the mode dial to **C** to call the setting stored in [Custom Mode].

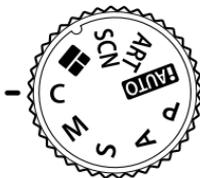

Processing options (Picture Mode)

Select a picture mode and make individual adjustments to contrast, sharpness, and other parameters. Changes to each picture mode are stored separately.

1 Select [Picture Mode] in  shooting menu 1.



2 Select an option with Δ / ∇ and press OK .

 Vivid	Produces vivid colors.
 Natural	Produces natural colors.
 Muted	Produces flat tones.
 Portrait	Produces beautiful skin tones.
 Monotone	Produces black and white tone.
 Pop Art	Choose an art filter and select the desired effect.
 Soft Focus	
 Pale&Light Color	
 Light Tone	
 Grainy Film	
 Pin Hole	
 Diorama	
 Cross Process	
 Gentle Sepia	
 Dramatic Tone	
 Key Line	

3 Press to display settings for the selected option.

		 - 	
Contrast	Distinction between light and dark	✓	✓
Sharpness	Sharpness of the image	✓	✓
Saturation	Vividness of the color	✓	—
Gradation	Adjust tone (gradation).		
Auto	Divides the image into detailed regions and adjusts the brightness separately for each region. This is effective for images with areas of large contrast in which the whites appear too bright or the blacks appear too dark.	✓	✓
Normal	Use [Normal] mode for general uses.		
High Key	Gradation for a bright subject.		
Low Key	Gradation for a dark subject.		
B&W Filter	Creates a black and white image. The filter color is brightened and the complementary color is darkened.		
N:Neutral	Creates a normal black and white image.		
Ye:Yellow	Reproduces clearly defined white cloud with natural blue sky.	—	✓
Or:Orange	Slightly emphasizes colors in blue skies and sunsets.		
R:Red	Strongly emphasizes colors in blue skies and brightness of crimson foliage.		
G:Green	Strongly emphasizes colors in red lips and green leaves.		
Pict. Tone	Colors the black and white image.		
N:Neutral	Creates a normal black and white image.		
S:Sepia	Sepia	—	✓
B:Blue	Bluish		
P:Purple	Purplish		
G:Green	Greenish		

Cautions

- Changes to contrast have no effect at settings other than [Normal].

Image quality (Record Mode)

Select an image quality. You can select a separate image quality for photographs and movies. This is the same as the [Record Mode] (P. 34) item in [Live Control].

- You can change the JPEG image size and compression ratio combination, and  and  pixel counts.  set (P. 53), [Pixel Count] (P. 53)

Setting the image aspect (Image Aspect)

You can change the aspect ratio (horizontal-to-vertical ratio) when taking pictures. Depending on your preference, you can set the aspect ratio to [4:3] (standard), [16:9], [3:2] or [1:1].

⚠ Cautions

- JPEG images are cropped to the selected aspect ratio; RAW images, however, are not cropped but are instead saved with information on the selected aspect ratio.
- When RAW images are played back, the selected aspect ratio is shown by a frame.

Disable the button function (🔒 Lock)

Select [On] to disable the \triangleright , ∇ and sub dial in shooting mode.

Varying settings over a series of photographs (Bracketing)

Bracketing enables you to take a series of shots at different exposure settings. Select the exposure compensation from 0.3 EV, 0.7 EV, or 1.0 EV. Bracketing is available in **P**, **A**, **S**, and **M** modes. The camera continues to take shots in the following order while the shutter button is pressed all the way down: no modification, negative, positive. Number of shots: 3

1 Select [Bracketing] in shooting menu 2.



2 Select the exposure compensation using Δ ∇ .

- Bracketing is available after pressing the button (∇) in the monitor and selecting [BKT].



- The camera modifies exposure by varying aperture and shutter speed (mode **P**), shutter speed (modes **A** and **M**), or aperture (mode **S**).
- The camera brackets the value currently selected for exposure compensation.
- When an art filter (-) selected in [Picture Mode] (P. 32, 42), the filter effect is not applied.

Wireless remote control flash photography (Remote Flash)

The built-in flash unit and external flash units that offer a remote control mode and are designated for use with this camera can be used for wireless flash photography.

 “Wireless remote control flash photography” (P. 75)

Setting the flash timing (Sync)

You can set the flash timing. For [ Sync 1], flash fires as shutter opens, while flash fires just before the shutter closes for [ Sync 2], creating a stream of light behind moving light sources.

Shooting larger pictures than when using optical zoom with low degrading of image quality (Super-Res Zoom)

Selecting [On] enables super-resolution zoom with minimal loss of image quality to allow greater magnification than possible when using the optical zoom.

Cautions

- Available only if [] is selected for image size.

Automatically rotating images shot with the camera in a vertical position during playback (Pic Orientation)

Information about the vertical/horizontal orientation of the camera during shooting is recorded with images. Images are automatically rotated during playback.

Cautions

- This function may not work properly if the camera is facing up or down during shooting.

▶ Playback Menu



- ▶ (P. 28)
- Edit (P. 46)
- ▶ (P. 59)

- Reset Protect (P. 47)
- Connection to Smartphone (P. 47)

Editing still images (Edit)

Recorded images can be edited and saved as new images.

- 1 Select [Edit] in the ▶ playback menu and press **OK**.
- 2 Use **◀▶** to select the image to be edited and press **OK**.
 - [RAW Data Edit] is displayed if the picture is a RAW image, [JPEG Edit] if it is a JPEG image. If the image was recorded in RAW+JPEG format, both [RAW Data Edit] and [JPEG Edit] will be displayed. Select the menu for the image to be edited.
- 3 Select [RAW Data Edit] or [JPEG Edit] and press **OK**.

RAW Data Edit	Create a JPEG copy of a RAW image edited according to the settings. The editing was done with the current settings. Set the camera settings before editing.
JPEG Edit	Choose from the following options: [Shadow Adj]: Brightens a dark backlit subject. [Redeye Fix]: Reduces the red-eye phenomenon during flash shooting. []: Use the sub dial to choose the size of the crop and Δ ∇ ◀▶ to position the crop. [Aspect]: Changes the aspect ratio of images from 4:3 (standard) to [3:2], [16:9] or [1:1]. After changing the aspect ratio, use Δ ∇ ◀▶ to specify the trimming position. []: Converts the image file size to 1280 × 960, 640 × 480, or 320 × 240. [e-Portrait]: Makes skin look smooth and translucent. You may not be able to compensate depending on the image if face detection fails.



- 4 When the settings are complete, press **OK**.
 - The settings will be applied to the image.
- 5 Select [Yes] and press **OK**.
 - The edited image is stored.

⚠ Cautions

- Movies cannot be edited.
- Red-eye correction may not work depending on the image.
- Editing of a JPEG image is not possible in the following cases:
 - When an image is processed on a PC, when there is not enough space in the card memory, when an image is recorded on another camera
- When resizing ([) an image, you cannot select a larger number of pixels than was originally recorded.
- [) and [Aspect] can only be used to edit images with an aspect ratio of 4:3 (standard).

■ Audio recording

Add an audio recording (up to 4 sec. long) to the current photograph.
This is the same function as [) during playback. (P. 27)

Canceling all protections (Reset Protect)

This function lets you cancel the protection of several images at one time.

- 1 Select [Reset Protect] in the [) playback menu.
- 2 Select [Yes] and press () .

Using the Smartphone connection option (Connection to Smartphone)

Use a commercially available FlashAir (wireless LAN mounted) card to view images directly on a smartphone or PC that has Wi-Fi connectivity or to transfer images between the camera and a smartphone or PC that has Wi-Fi connectivity. FlashAir cards that have been set by another camera or device should be formatted before use.
 "Using the card" (P. 72)

To download smartphone applications, see the URL below.
<http://olympuspen.com/OIShare/>

■ Making the connection settings

- 1 Select [Connection to Smartphone] in the [) playback menu and press () .
- 2 Select [Connection Settings] and press () .
- 3 Enter the [SSID Setting] and press () .
 - This becomes the FlashAir card ID name used to identify this card from the device to be connected.
- 4 Enter the password, and press () .
 - This is the password used when connecting from another device. Set a password between 8 and 63 characters long.
 - The message "Initial setting completed" will be displayed and the settings are complete.

■ Connecting

- 1 Select [Connection to Smartphone] in the  playback menu and press .
- 2 Select the connection method and press .

Private Connection	Connect using the same preset password each time.
One-Time Connection	Connect using a password that is valid for only one connection. Set the password and press  .

- 3 Select the camera's FlashAir as the access point using the device to be connected, and establish the connection.
 - Refer to the Instruction Manual of the device for the method of connecting to the access point.
 - When prompted to provide a password, enter the password set using the camera.
- 4 Open an internet browser on the device to be connected, and enter `http://FlashAir/` in the address bar.
 - The camera does not automatically turn off while the connection is established.

■ Ending the connection

Select [Break connection] from [Connection to Smartphone] in the  playback menu and press .

■ Changing the settings

Select [Connection Settings] from [Connection to Smartphone], and set the [SSID Setting] and [Password Setting] items.

f Setup Menu

Use the Setup Menu to set the basic camera functions.



Option	Description	
⌚ (Date/time setting)	Set the camera clock. <ol style="list-style-type: none"> 1) Use Δ ∇ to select the year for [Y]. 2) Press \triangleright to save the setting for [Y]. 3) As in Steps 1 and 2, use Δ ∇ \langle \triangleright to set [M] (month), [D] (day), [Time] (hours and minutes), and [Y/M/D] (date order), and then press the \odot button. <ul style="list-style-type: none"> • For precise time setting, press the \odot button as the time signal strikes 00 seconds. 	7
World Time	You can set your home and destination to change the date and time display.	—
 (Changing the display language)	You can change the language used for the on-screen display and error messages from English to another language.	—
 (Monitor brightness adjustment)	You can adjust the brightness and color temperature of the monitor. Color temperature adjustment will affect only the monitor display during playback. Use \langle \triangleright to highlight F (color temperature) or S (brightness) and Δ ∇ to adjust the value.	
Rec View	Choose whether pictures are displayed immediately after shooting and for how long. This is useful for making a brief check of the picture you have just taken. Pressing the shutter button halfway while checking the picture lets you resume shooting immediately. [1sec]–[20sec]: Selects the number of seconds to display each picture. Can be set in units of 1 second. [Off]: The picture being recorded to the card is not displayed. [Auto P]: Displays the image being recorded, and then switches to playback mode. This is useful for erasing a picture after checking it.	—
Power On	[Yes]: If you hold down P , the camera turns on and starts up in playback mode. [No]: The camera does not turn on. Press the ON/OFF button to turn on the camera.	—

Camera start-up settings for operation and shooting can be customized using the custom menus.

Custom Menu

AF (P. 51)	AF Mode	Exp/ISO (P. 52)	Metering
	AF Area		[■■■]+Metering
	AF Illuminat.		Noise Reduct.
	☉ Face Priority		Noise Filter
Button/Dial (P. 51)	Function	Custom (P. 53)	ISO
	Dial Function		ISO-Auto Set
	Dial Direction		Slow Llimit
Connection/Sound (P. 51)	HDMI	WB (P. 53)	WB
	Video Out		Set
	(Beep sound)		Pixel Count
	Volume		Record (P. 54)
USB mode	Movie (P. 54)	Movie	
Display (P. 52)		/Info Setting	Utility (P. 54)
	Displayed Grid	Pixel Mapping	
	Control Setting	Touch Screen Settings	
	Picture Mode Setting	Touch Calibration.	
	Live View Boost		Eye-Fi
	Sleep		

■ Customizing the setting

- 1 Press the **MENU** button to display the menus.
- 2 Select Custom Menu using Δ ∇ , and press OK .
- 3 Use Δ ∇ to select a tab and press OK .
- 4 Select an item using Δ ∇ and press OK to display options for the selected item.
- 5 Use Δ ∇ to highlight an option and press OK to select.
 - For details on each menu item, refer to the following pages.

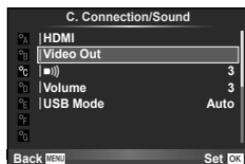

AF

MENU →  → 

Option	Description	
AF Mode	Choose the AF mode.	37
AF Area	Choose the AF target mode.	21
AF Illuminat.	Select [Off] to disable the AF illuminator.	—
 Face Priority	The camera gives priority to the faces of human portrait subjects during focusing.	38

Button/Dial

MENU →  → 

Option	Description	
 Function	Choose the function assigned to the Fn button. <ul style="list-style-type: none"> • IS Mode  • Picture Mode  • WB • Metering • /☺ • AF Mode • Aspect • ISO •  Image Quality •  Face Priority •  Image Quality • ND Filter Setting 	55
Dial Function	Choose the roles played by the control ring and sub dials.	77
Dial Direction	Choose the direction in which the dials are rotated to adjust shutter speed or aperture or to move the cursor.	77

Connection/Sound

MENU →  → 

Option	Description	
HDMI	[HDMI Out]: Selecting the digital video signal format for connecting to a TV via an HDMI cable. [HDMI Control]: Select [On] to allow the camera to be operated using remotes for TVs that support HDMI control.	56, 57
Video Out	Choose the video standard ([NTSC] or [PAL]) used in your country or region.	56
 (Beep sound)	You can adjust the volume of the shutter sound and the beep sound emitted when performing operations. Set to 0 to turn the sound off.	—
Volume	Adjust playback volume.	11, 27
USB Mode	Choose a mode for connecting the camera to a computer or printer. Choose [Auto] to display USB mode options every time the camera is connected.	—

Option	Description																																				
/Info Settings	Choose the information displayed when the INFO button is pressed. [Info]: Choose the information displayed in full frame playback. [LV-Info]: Choose the information displayed when the camera is in shooting mode. [Settings]: Choose the information displayed in index and calendar playback.	58																																			
Displayed Grid	To choose a framing guide from [], [], [], or [], select [Displayed Grid].	—																																			
Control Settings	Choose the controls displayed in each shooting mode. <table border="1" style="margin-left: 20px;"> <thead> <tr> <th rowspan="2">Controls</th> <th colspan="5">Shooting mode</th> </tr> <tr> <th></th> <th>P/A/S/M</th> <th></th> <th>ART</th> <th>SCN</th> </tr> </thead> <tbody> <tr> <td>Live Control (P. 31)</td> <td>On/Off</td> <td>On/Off</td> <td>On/Off</td> <td>On/Off</td> <td>On/Off</td> </tr> <tr> <td>Live Guide (P. 20)</td> <td>On/Off</td> <td>—</td> <td>—</td> <td>—</td> <td>—</td> </tr> <tr> <td>Art Menu</td> <td>—</td> <td>—</td> <td>—</td> <td>On/Off</td> <td>—</td> </tr> <tr> <td>Scene Menu</td> <td>—</td> <td>—</td> <td>—</td> <td>—</td> <td>On/Off</td> </tr> </tbody> </table>	Controls	Shooting mode						P/A/S/M		ART	SCN	Live Control (P. 31)	On/Off	On/Off	On/Off	On/Off	On/Off	Live Guide (P. 20)	On/Off	—	—	—	—	Art Menu	—	—	—	On/Off	—	Scene Menu	—	—	—	—	On/Off	57
Controls	Shooting mode																																				
		P/A/S/M		ART	SCN																																
Live Control (P. 31)	On/Off	On/Off	On/Off	On/Off	On/Off																																
Live Guide (P. 20)	On/Off	—	—	—	—																																
Art Menu	—	—	—	On/Off	—																																
Scene Menu	—	—	—	—	On/Off																																
Picture Mode Settings	Display only the selected picture mode when the live control is used to select a picture mode.	—																																			
Live View Boost	If [On] is selected, priority will be given to making images clearly visible; the effects exposure compensation and other settings will not be visible in the monitor.	—																																			
Sleep	The camera will enter sleep (energy saving) mode if no operations are performed for the selected period. The camera can be reactivated by pressing the shutter button halfway.	—																																			

Option	Description	
Metering	Choose a metering mode according to the scene.	36
+Metering	If [On] is selected, the exposure is measured using the selected AF target.	21
Noise Reduct.	This function reduces the noise that is generated during long exposures. [Auto]: Noise reduction is only performed at slow shutter speeds. [On]: Noise reduction is performed with every shot. [Off]: Noise reduction off. <ul style="list-style-type: none"> • Noise reduction requires about twice the time needed to record the image. • Noise reduction turns off automatically during sequential shooting. • This function may not work effectively with some shooting conditions or subjects. 	15

Option	Description	
Noise Filter	Choose the amount of noise reduction performed at high ISO sensitivities.	—
ISO	Set ISO sensitivity.	38
ISO-Auto Set	Choose the upper limit and default value used for ISO sensitivity when [Auto] is selected for [ISO]. [High Limit]: Choose the upper limit for auto ISO sensitivity selection. [Default]: Choose the default value for auto ISO sensitivity selection.	—

Custom

MENU → →

Option	Description	
Slow Limit	Choose the slowest shutter speed available when a flash is used. Available in P or A mode.	22
+	When set to [On], it will be added to the exposure compensation value and flash intensity control will be performed.	—

←/WB

MENU → →

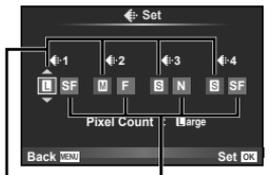
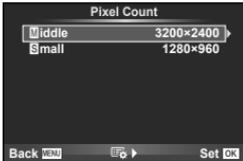
Option	Description	
WB	Choose the white balance mode.	33
Set	The record mode for JPEG photographs can be selected from four combinations of image size and compression rate. The camera offers a choice of three sizes and four compression rates for each combination. <ol style="list-style-type: none"> Use to select a combination ([-1] – [-4]) and use to change. Press .  Number of pixels Compression rate	34, 74
Pixel Count	Choose the pixel count for [M]- and [S]-size images. <ol style="list-style-type: none"> Select [Middle] or [Small] and press . Choose a pixel count and press . 	34, 74

Record

MENU → ⚙️ → 📷

Option	Description	
File Name	[Auto]: Even when a new card is inserted, the file numbers are retained from the previous card. File numbering continues from the last number used or from the highest number available on the card. [Reset]: When you insert a new card, the folder numbers starts at 100 and the file name starts at 0001. If a card containing images is inserted, the file numbers start at the number following the highest file number on the card.	—

Movie

MENU → ⚙️ → 📷

Option	Description	
Movie 🎤	Choose [Off] to record silent movies.	—
Wind Noise Reduction	Reduce wind noise during recording.	—

Utility

MENU → ⚙️ → 📷

Option	Description	
Pixel Mapping	The pixel mapping feature allows the camera to check and adjust the image pickup device and image processing functions.	71
Touch Screen Settings	Activate the touch screen. Choose [Off] to disable the touch screen.	—
Touch Calibration.	Calibrating the touch panel. Touch the panel following the instructions on the screen.	—
Eye-Fi*	Enable or disable upload when using an Eye-Fi card.	72

* Use in accordance with local regulations. Onboard airplanes and in other locations in which the use of wireless devices is prohibited, remove the Eye-Fi card from the camera or select [Off] for [Eye-Fi].

The camera does not support the "endless" Eye-Fi mode.

■ Function

MENU →  →  → [**Fn** Function]

You can assign any number of the following functions to the **Fn** button.

Select the check boxes for the functions you want to assign.

The functions that have been assigned change each time you press the **Fn** button. The value can be changed using the control ring.

When you changed the functions by turning the control ring while holding down the **Fn** button, the value can be changed by turning the control ring after releasing the **Fn** button. To change the value, turn the control ring after releasing the **Fn** button.

IS Mode	Set the image stabilizer.
Picture mode	Set the finish and art filters for an image.
WB	Adjust white balance.
	Choose a sequential shooting or self timer option.
Aspect	Adjust the aspect ratio.
 Image Quality	Adjust the image quality for photographs.
 Image Quality	Adjust the image quality for movies.
	Choose a flash mode.
	Adjust the flash output.
Metering	Adjust the exposure method.
AF Mode	Adjust the AF method.
ISO	Set ISO sensitivity.
 Face priority	Set the face priority.
ND Filter Setting	Set the ND filter.

Viewing camera images on TV

Use the AV cable (sold separately) to playback recorded images on your TV. You can playback high-definition images on a high-definition TV by connecting it to the camera using the HDMI cable (sold separately).

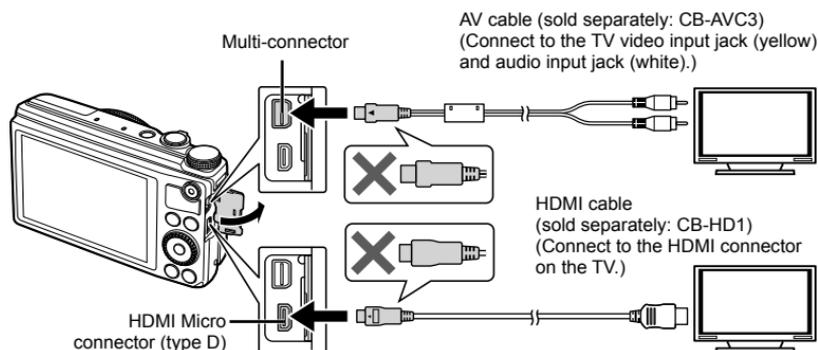

- 1 Use the cable to connect the camera to the TV.
 - Adjust settings on the TV before connecting the camera.
 - Choose the camera video mode before connecting the camera via an AV cable.
▶ [Video Out] (P. 51)
- 2 Choose the TV input channel.
 - The camera monitor turns off when the cable is connected.
 - Press the button when connecting via an AV cable.

! Cautions

- For details on changing the input source of the TV, refer to the TV's instruction manual.
- Depending on the TV's settings, the displayed images and information may become cropped.
- If the camera is connected using both an A/V and HDMI cable, it will assign priority to HDMI.
- If the camera is connected via an HDMI cable, you will be able to choose the digital video signal type. Choose a format that matches the input format selected with the TV.

1080i	Priority is given to 1080i HDMI output.
720p	Priority is given to 720p HDMI output.
480p/576p	480p/576p HDMI output. 576p is used when [PAL] is selected for [Video Out] (P. 51).

- You cannot shoot pictures or movies when the HDMI cable is connected.
- Do not connect the camera to other HDMI output devices. Doing so may damage the camera.
- HDMI output is not performed while connected via USB to a computer or printer.

Using the TV remote control

The camera can be operated by a TV remote control when connected to a TV that supports HDMI control.

- 1 Select [HDMI] in Custom Menu tab .
- 2 Select [HDMI Control] and choose [On].
- 3 Operate the camera by using the TV remote control.
 - You can operate the camera by following the operation guide displayed on the TV.
 - During single-frame playback, you can display or hide the information display by pressing the "Red" button, and display or hide the index display by pressing the "Green" button.
 - Some televisions may not support all features.

Choosing the control panel displays (Control Settings)

Choose the controls displayed in each shooting mode. The displayed controls can be changed by selecting check boxes.

IAUTO

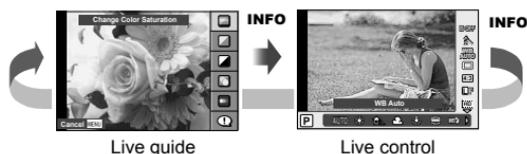

P/A/S/M/



ART/SCN

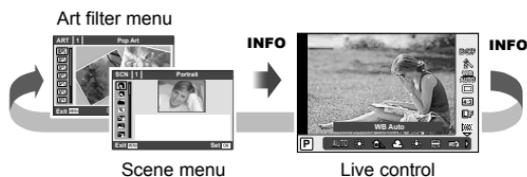

Adding information displays ([Info] / Info Settings)

Use [Info] to add the following playback information displays. The added displays are displayed by repeatedly pressing the **INFO** button during playback. You can also choose to not show displays that appear at the default setting.



Histogram display



Highlight & Shadow display

To select the number of frames displayed, check desired items for [Settings].



Single-frame playback



4 frames



9 frames, 25 frames

Index display

5 Printing Pictures

Print reservation (DPOF)

You can save digital “print orders” to the memory card listing the pictures to be printed and the number of copies of each print. You can then have the pictures printed at a print shop that supports DPOF or print the pictures yourself by connecting the camera directly to a DPOF printer. A memory card is required when creating a print order.

Creating a print order

- 1 Press **OK** during playback and select **[P]**.
- 2 Select **[P]** or **[ALL]** and press **OK**.

Individual pictures

Press **<D>** to select the frame that you want to set as print reservation, then press **△▽** to set the number of prints.

- To set print reservation for several pictures, repeat this step. Press **OK** when all the desired pictures have been selected.

All pictures

Select **[ALL]** and press **OK**.

- 3 Select the date and time format and press **OK**.

No	The pictures are printed without the date and time.
Date	The pictures are printed with the shooting date.
Time	The pictures are printed with the shooting time.

- 4 Select **[Set]** and press **OK**.

! **Cautions**

- The camera can not be used to modify print orders created with other devices. Creating a new print order deletes any existing print orders created with other devices.
- Print orders can not include RAW images or movies.



Removing all or selected pictures from the print order

You can reset all print reservation data or just the data for selected pictures.

- 1 Press **OK** during playback and select **[]**.
- 2 Select **[]** and press **OK**.
 - To remove all pictures from the print order, select **[Reset]** and press **OK**.
To exit without removing all pictures, select **[Keep]** and press **OK**.
- 3 Press **<|>** to select images you wish to remove from the print order.
 - Use **▽** to set the number of prints to 0. Press **OK** once you have removed all the desired pictures from the print order.
- 4 Select the date and time format and press **OK**.
 - This setting is applied to all frames with print reservation data.
- 5 Select **[Set]** and press **OK**.

Direct printing (PictBridge)

By connecting the camera to a PictBridge-compatible printer with the USB cable, you can print out recorded pictures directly.

Connecting the camera

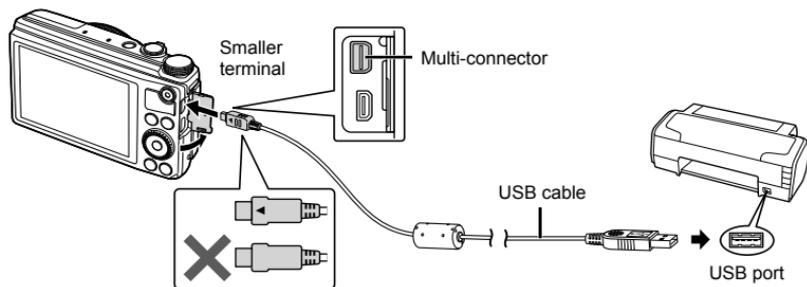

! Cautions

- Use a fully charged battery for printing.
- RAW images and movies can not be printed.

Easy printing

- 1 Use **<|>** to display the pictures you want to print on the camera.
- 2 Connect the camera to the printer using the supplied USB cable.
- 3 Press **▷**.
 - The picture selection screen appears when printing is completed. To print another picture, use **<|>** to select the image and press **OK**.

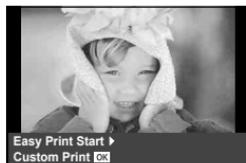

- To exit, unplug the USB cable from the camera while the picture selection screen is displayed.

Custom printing

1 Connect the camera to the printer using the supplied USB cable and turn the camera on.

- When the camera is turned on, a dialog should be displayed in the monitor prompting you to choose a host. If it is not, select [Auto] for [USB Mode] (P. 51) in the camera custom menus.

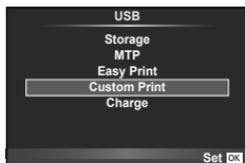

2 Use Δ ∇ to select [Custom Print].

- [Do Not Remove USB Cable] will be displayed, followed by a print-mode selection dialog.
- If the screen is not displayed after a few minutes, disconnect the USB cable and start again from Step 1.

3 Follow the operation guide to set a print option.

Selecting the print mode

Select the type of printing (print mode). The available print modes are as shown below.

Print	Prints selected pictures.
All Print	Prints all the pictures stored in the card and makes one print for each picture.
Multi Print	Prints multiple copies of one image in separate frames on a single sheet.
All Index	Prints an index of all the pictures stored in the card.
Print Order	Prints according to the print reservation you made. If there is no picture with print reservation, this is not available.

Setting the print paper items

This setting varies with the type of printer. If only the printer's STANDARD setting is available, you cannot change the setting.

Size	Sets the paper size that the printer supports.
Borderless	Selects whether the picture is printed on the entire page or inside a blank frame.
Pics/sheet	Selects the number of pictures per sheet. Displayed when you have selected [Multi Print].

Selecting pictures you want to print

Select pictures you want to print. The selected pictures can be printed later (single-frame reservation) or the picture you are displaying can be printed right away.



Print (OK)	Prints the currently displayed picture. If there is a picture that [Single Print] reservation has already been applied to, only that reserved picture will be printed.
Single Print (▲)	Applies print reservation to the currently displayed picture. If you want to apply reservation to other pictures after applying [Single Print], use <◀▶ to select them.
More (▽)	Sets the number of prints and other items for the currently displayed picture, and whether or not to print it. For operation, refer to "Setting printing data" in the next section.

Setting printing data

Select whether to print printing data such as the date and time or file name on the picture when printing. When the print mode is set to [All Print] and [Option Set] is selected, the following options appears.

	Sets the number of prints.
Date	Prints the date and time recorded on the picture.
File Name	Prints the file name recorded on the picture.
	Trims the picture for printing. Set the trimming size with the control ring or sub dial, and set the trimming position with ▲▼◀▶.

2 Once you have set the pictures for printing and printing data, select [Print], then press (OK).

- To stop and cancel printing, press (OK). To resume printing, select [Continue].

■ Cancelling printing

To cancel printing, highlight [Cancel] and press (OK). Note that any changes to the print order will be lost; to cancel printing and return to the previous step, where you can make changes to the current print order, press **MENU**.

Installing Software

■ Windows

1 Insert the supplied CD in a CD-ROM drive.

Windows XP

- A "Setup" dialog will be displayed.

Windows Vista/Windows 7/Windows 8

- An Autorun dialog will be displayed. Click "OLYMPUS Setup" to display the "Setup" dialog.



! Caution

- If the "Setup" dialog is not displayed, select "My Computer" (Windows XP) or "Computer" (Windows Vista/Windows 7) from the start menu. Double-click the CD-ROM (OLYMPUS Setup) icon to open the "OLYMPUS Setup" window and then double-click "LAUNCHER.EXE".
- If a "User Account Control" dialog is displayed, click "Yes" or "Continue".

2 Follow the on-screen instructions on your computer.

! Caution

- If nothing is displayed on the camera screen even after connecting the camera to the computer, the battery may be exhausted. Use a full-charged battery.

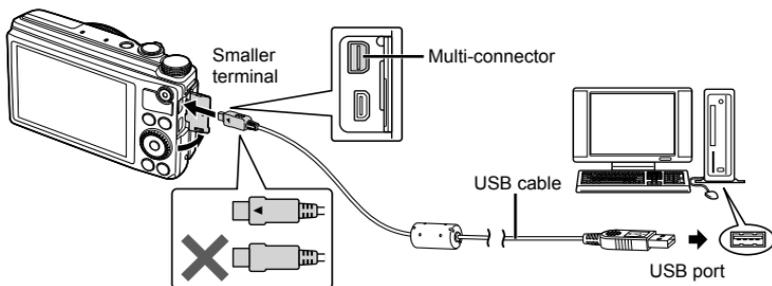

! Caution

- When the camera is connected to another device via USB, a message will be displayed prompting you to choose a connection type. Select [Storage].

3 Register your Olympus product.

- Click the “Registration” button and follow the on-screen instructions.

4 Install OLYMPUS Viewer 3.

- Check the system requirements before beginning installation.
- Click the “OLYMPUS Viewer 3” button and follow the on-screen instructions to install the software.

Operating System	Windows XP (Service Pack 2 or later)/Windows Vista/ Windows 7/Windows 8
Processor	Pentium 4 1.3 GHz or better (Core 2 Duo 2.13 GHz or better required for movies)
RAM	1 GB or more (2 GB or more recommended)
Free Hard Drive Space	3 GB or more
Monitor Settings	1024 × 768 pixels or more Minimum 65,536 colors (16,770,000 colors recommended)

- See online help for information on using the software.

■ Macintosh

1 Insert the supplied CD in a CD-ROM drive.

- The disk contents should automatically be displayed in the Finder. If they are not, double-click the CD icon on the desktop.
- Double-click the “Setup” icon to display the “Setup” dialog.



2 Install OLYMPUS Viewer 3.

- Check the system requirements before beginning installation.
- Click the “OLYMPUS Viewer 3” button and follow the on-screen instructions to install the software.



Operating System	Mac OS X v10.5–v10.8
Processor	Intel Core Solo/Duo 1.5 GHz or better (Core 2 Duo 2.13 GHz or better required for movies)
RAM	1 GB or more (2 GB or more recommended)
Free Hard Drive Space	3 GB or more
Monitor Settings	1024 × 768 pixels or more Minimum 32,000 colors (16,770,000 colors recommended)

- Other languages can be selected from the language combo box. For information on using the software, see online help.

Copying pictures to a computer without OLYMPUS Viewer 3

Your camera supports the USB Mass Storage Class. You can transfer images to a computer by connecting the camera to the computer with the provided USB cable. The following operating systems are compatible with the USB connection:

Windows	Windows XP Home Edition / Windows XP Professional / Windows Vista / Windows 7 / Windows 8
Macintosh	Mac OS X version 10.3 or later

- 1 Turn the camera off and connect it to the computer.
 - The location of the USB port varies with the computer. For details, refer to your computer's manual.
- 2 Turn on the camera.
 - The selection screen for the USB connection is displayed.
- 3 Press Δ ∇ to select [Storage]. Press OK .

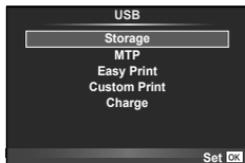

- 4 The computer recognizes the camera as a new device.

! Cautions

- If your computer is running Windows Vista/Windows 7/Windows 8, select [MTP] in Step 3 to use Windows Photo Gallery.
- Data transfer is not guaranteed in the following environments, even if your computer is equipped with a USB port.
 - Computers with a USB port added by means of an extension card, etc.
 - Computers without a factory-installed OS and home-built computers
- Camera controls can not be used while the camera is connected to a computer.
- If the dialog shown in Step 2 is not displayed when the camera is connected, select [Auto] for [USB Mode] (P. 51) in the camera custom menus.

If the camera does not work as intended, or if an error message is displayed on the screen, and you are unsure of what to do, refer to the information below to fix the problem(s).

Troubleshooting

■ Battery

The camera does not work even when batteries are installed.

- Insert recharged batteries in the correct direction.  "Inserting and removing the battery and card" (P. 5)
- Battery performance may have been reduced temporarily due to low temperature. Take the batteries out of the camera, and warm them by putting them in your pocket for a while.

■ Card/Internal memory

An error message is displayed.

-  "Error message" (P. 67)

■ Shutter button

No picture is taken when the shutter button is pressed.

- Cancel sleep mode.
To save battery power, the camera automatically goes into sleep mode and the monitor turns off if no operations are performed for a pre-determined period of times while the camera is on. No picture is taken even if the shutter button is fully pressed in this mode. Operate the zoom lever or other buttons to restore the camera from sleep mode before taking a picture. If the camera is left for another 5 minutes, it automatically turns off. Press the **ON/OFF** button to turn the camera on.
- Press the  button to switch to the shooting mode.
- Wait until  (flash charge) stops blinking before taking pictures.

- With prolonged camera use, the internal temperature may increase, resulting in automatic shutdown. If this occurs, wait until the camera has sufficiently cooled. The camera's external temperature may also increase during use, however this is normal and does not indicate malfunction.

■ Monitor

Difficult to see.

- Condensation may have occurred. Turn off the power, and wait for the camera body to become acclimated to the surrounding temperature and dry out before taking pictures.

The light is caught in the picture.

- Shooting with flash in dark situations results in an image with many flash reflections on dust in the air.

■ Date and time function

Date and time settings return to the default setting.

- If the batteries are removed and left out of the camera for about 3 days^{*1}, the date and time settings return to the default setting, and must be reset.

^{*1} The time until the date and time settings return to the default setting varies depending on how long the batteries have been loaded.

-  "Turning on the camera and making the initial settings" (P. 7)

Error message

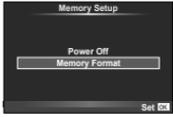
Monitor indication	Possible cause	Corrective action
 Card Error	There is a problem with the card.	Insert the card again. If the problem persists, format the card. If the card cannot be formatted, it cannot be used.
 Write Protect	Writing to the card is prohibited.	The card write-protect switch is set to the "LOCK" side. Release the switch.  "SD/SDHC/SDXC card write-protect switch" (P. 73)
 Memory Full	<ul style="list-style-type: none"> The internal memory is full. No more pictures can be taken or no more information such as print reservation can be recorded. There is no space in the internal memory and print reservation or new images cannot be recorded. 	Insert the card or erase unwanted pictures. Before erasing, download important images to a PC.
 Card Full	<ul style="list-style-type: none"> The card is full. No more pictures can be taken or no more information such as print reservation can be recorded. There is no space in the card and print reservation or new images cannot be recorded. 	Replace the card or erase unwanted pictures. Before erasing, download important images to a PC.
	Card cannot be read. Card may not have been formatted.	Use Δ ∇ to select [Format], and press the \odot button. Next, use Δ ∇ to select [Yes], and press the \odot button.*
	There is a problem with the internal memory.	Use Δ ∇ to select [Memory Format], and press the \odot button. Next, use Δ ∇ to select [Yes], and press the \odot button.*
 No Picture	There are no pictures on the card.	The card contains no pictures. Record pictures and play back.
 Picture Error	The selected picture cannot be displayed for playback due to a problem with this picture. Or the picture cannot be used for playback on this camera.	Use image processing software to view the picture on a PC. If that cannot be done, the image file is damaged.

* All data will be erased.

Monitor indication	Possible cause	Corrective action
 The Image Cannot Be Edited	Pictures taken with another camera cannot be edited on this camera.	Use image processing software to edit the picture.
	The internal temperature of the camera has risen due to sequential shooting.	Turn off the camera and wait for the internal temperature to cool.
 Internal camera temperature is too high. Please wait for cooling before camera use.		Wait a moment for the camera to turn off automatically. Allow the internal temperature of the camera to cool before resuming operations.
 Battery Empty	The battery is drained.	Charge the battery.
 No Connection	The camera is not connected to the computer or printer correctly.	Disconnect the camera and connect it again correctly.
 No Paper	There is no paper in the printer.	Load some paper in the printer.
 No Ink	The printer has run out of ink.	Replace the ink cartridge in the printer.
 Jammed	The paper is jammed.	Remove the jammed paper.
Settings Changed	The printer's paper cassette has been removed or the printer has been manipulated while making settings on the camera.	Do not manipulate the printer while making settings on the camera.
 Print Error	There is a problem with the printer and/or camera.	Turn off camera and printer. Check the printer and remedy any problems before turning the power on again.
 Cannot Print	Pictures recorded on other cameras may not be printed on this camera.	Use a personal computer to print.

Shooting tips

When you are unsure of how to take a picture that you envision, refer to the information below.

■ Focusing

Focusing on the subject.

- **Take pictures using the touch screen.**  P. 29
- **Taking a picture of a subject not in the center of the monitor.**  P. 37
After focusing on an object at the same distance as the subject, compose the shot, and take the picture.
- **Using the face priority AF.**  P. 38
- **Taking a picture of a shadowy subject.**  P. 51
Using the AF illuminator makes focusing easier.
- **Taking a picture of subjects where autofocus is difficult.**
In the following cases, after focusing on an object (by pressing the shutter button halfway down) with high contrast at the same distance as the subject, compose the shot, and take the picture.



Subject with low contrast



Excessively bright light in center of frame

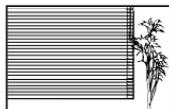

Subject containing no vertical lines^{*1}



Subjects at different distances^{*1}

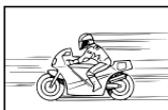

Fast-moving subject



Subject not inside AF area

- *1 It is also effective to compose the shot by holding the camera vertically to focus, and then returning to the horizontal position to take the picture.

■ Camera shake

Taking pictures without camera shake.

- **Taking pictures using [Image Stabilizer].**  P. 32
The image pickup device shifts to correct for camera shake even if the ISO sensitivity is not increased. This function is also effective when taking pictures at a high zoom magnification.
- **Select [ Sport] in the scene mode.**  P. 17
The [ Sport] mode uses a fast shutter speed and can reduce the blur incurred by a moving subject.
- **Taking pictures at a high ISO sensitivity.**  P. 38
If a high ISO sensitivity is selected, pictures can be taken at a high shutter speed even at locations where a flash cannot be used.

■ Exposure (brightness)

Taking pictures with the right brightness.

- **Select [Auto] for [Gradation] in picture mode.**  P. 42
- **Using the face priority AF.**  P. 38
- **Taking pictures using [Spot Metering].**  P. 36
Brightness is matched with a subject in the center of the screen and the image is not affected by background light.
- **Taking pictures using [Fill In] flash.**  P. 22
A subject against backlight is brightened.
- **Taking pictures of a white beach or snow scene.**  P. 17
Select [ Beach & Snow] in the scene mode.
- **Taking pictures using exposure compensation.**  P. 21
Adjust the brightness while viewing the screen for taking the picture. Normally, taking pictures of white subjects (such as snow) results in images that are darker than the actual subject. Use the exposure compensation to adjust in the positive (+) direction to express whites as they appear. When taking pictures of black subjects, on the other hand, it is effective to adjust in the negative (-) direction.

■ Color hue

Taking pictures with colors at the same shade as they appear.

- **Taking pictures by selecting white balance.**  P. 33
Best results in most environments can normally be obtained with the [WB Auto] setting, but for some subjects, you should try experimenting with different settings. (This is especially true for sunshade under a clear sky, mixed natural and artificial light settings, and so on.)

■ Image quality

Taking sharper pictures.

- **Taking pictures at a low ISO sensitivity.**  P. 38
If the picture is taken with a high ISO sensitivity, noise (small colored spots and color unevenness that were not in the original image) can occur, and the image can appear grainy.

Playback/Editing tips

■ Playback

Playing images in the internal memory.

- **Remove the card and display the images in internal memory.**  P. 5

Viewing images with high picture quality on a highdefinition TV

- **Connect the camera to the TV using an HDMI cable (sold separately).**  P. 56

■ Editing

Erasing the sound recorded to a still image.

- **Display a still image to erase the sound, and select [Erase] for .**  P. 27

Cleaning and storing the camera

Camera care

Exterior:

- Wipe gently with a soft cloth. If the camera is very dirty, soak the cloth in mild soapy water and wring well. Wipe the camera with the damp cloth and then dry it with a dry cloth. If you have used the camera at the beach, use a cloth soaked in clean water and well wrung.

Monitor:

- Wipe gently with a soft cloth.

Lens:

- Blow dust off the lens with a commercial blower, then wipe gently with a lens cleaner.

⚠ Cautions

- Do not use strong solvents such as benzene or alcohol, or a chemically treated cloth.
- Mold may form on the lens surface if the lens is left dirty.

Battery/USB-AC adapter:

- Wipe gently with a soft, dry cloth.

Storage

- When storing the camera for extended periods, remove the battery, USB-AC adapter and card, and keep in a cool, dry place that is well ventilated.
- Periodically insert the battery and test the camera functions.

⚠ Cautions

- Avoid leaving the camera in places where chemical products are handled since this may result in corrosion.

Pixel mapping - Checking the image processing functions

The pixel mapping feature allows the camera to check and adjust the image pickup device and image processing functions. After using the monitor or taking continuous shots, wait for at least one minute before using the pixel mapping function to ensure that it operates correctly.

1 Select [Pixel Mapping] in  Custom Menu (P. 50) tab .

2 Press , then press .

- The [Busy] bar is displayed when pixel mapping is in progress. When pixel mapping is finished, the menu is restored.

⚠ Cautions

- If you accidentally turn the camera off during pixel mapping, start again from Step 1.

Using a separately sold USB-AC adapter

The USB-AC adapter F-3AC (sold separately) can be used with this camera. Do not use any AC adapter other than the dedicated one. When using F-3AC, be sure to use the USB cable included with this camera.

Do not use any other AC adapter with this camera.

Using a separately sold charger

A charger (UC-50: sold separately) can be used to charge the battery.

Using your charger and USB-AC adapter abroad

- The charger and USB-AC adapter can be used in most home electrical sources within the range of 100 V to 240 V AC (50/60Hz) around the world. However, depending on the country or area you are in, the AC wall outlet may be shaped differently and the charger and USB-AC adapter may require a plug adapter to match the wall outlet. For details, ask at your local electrical shop or travel agent.
- Do not use travel voltage converters as they could damage your charger and USB-AC adapter.

8

Using the card

Cards compatible with this camera

Commercially available SD/SDHC/SDXC/Eye-Fi/FlashAir (wireless LAN mounted) card.

- For compatibility card details, visit the Olympus website.
- This camera can be used without a card by storing images in its internal memory.



■ FlashAir or Eye-Fi card

⚠ Cautions

- “FlashAir” SD cards have built-in wireless LAN and cannot be formatted. Use the software supplied with the FlashAir card to format the card.
- Use the FlashAir or Eye-Fi card in compliance with the laws and regulations of the country where the camera is used. Remove the FlashAir or Eye-Fi card from the camera or disable the card functions in airplanes and other locations where use is prohibited.
📶 [Eye-Fi] (P. 54)
- The FlashAir or Eye-Fi card may become hot during use.
- When using a FlashAir or Eye-Fi card, the battery may run out faster.
- When using a FlashAir or Eye-Fi card, the camera may function more slowly.

SD/SDHC/SDXC card write-protect switch

The SD/SDHC/SDXC card body has a write-protect switch. If you set the switch to the "LOCK" side, you will not be able to write to the card, delete data or format. Return the switch to enable writing.



Format card

Cards must be formatted with this camera before first use or after being used with other cameras or computers.

Checking the image saving location

The memory indicator shows whether the internal memory or card is being used during shooting and playback.

	Internal memory is being used
	Card is being used

! Cautions

- Performing [Card setup]/[Memory setup], [Erase], [Sel. Image] or [All Erase] may not completely erase all card data. When disposing of the card, damage the card to prevent the disclosure of personal data.

Readout/recording process of the card

During shooting, the icon (/) flashes while the camera is writing data. Never open the battery/card compartment cover or unplug the USB cable. This can not only damage the image data but also render the internal memory or card unusable.

Record mode and file size/number of storable still pictures

The file size in the table is approximate for files with a 4:3 aspect ratio.

Record mode	Number of pixels (Pixel Count)	Compression	File format	File size (MB)	Number of storable still pictures	
					Internal memory	Card*1
RAW	3968×2976	—	ORF	Approx. 18.5	2	200
1SF		1/2.7	JPEG	Approx. 8.8	4	430
1F		1/4		Approx. 6.1	6	620
1N		1/8		Approx. 3.3	11	1,160
1B		1/12		Approx. 2.3	16	1,630
2SF	3200×2400	1/2.7		Approx. 5.9	6	640
2F		1/4		Approx. 4.2	9	920
2N		1/8		Approx. 2.3	17	1,650
2B		1/12		Approx. 1.7	23	2,270
3SF	2560×1920	1/2.7		Approx. 4.0	9	960
3F		1/4		Approx. 2.8	13	1,360
3N		1/8		Approx. 1.7	23	2,310
3B		1/12		Approx. 1.3	31	3,060
4SF	1920×1440	1/2.7		Approx. 2.0	19	1,910
4F		1/4		Approx. 1.4	28	2,780
4N		1/8		Approx. 0.7	57	5,570
4B		1/12	Approx. 0.5	83	8,170	
5SF	1600×1200	1/2.7	Approx. 1.4	28	2,720	
5F		1/4	Approx. 1.0	41	3,950	
5N		1/8	Approx. 0.5	81	7,660	
5B		1/12	Approx. 0.3	114	11,140	
6SF	1280×960	1/2.7	Approx. 0.9	43	4,220	
6F		1/4	Approx. 0.6	62	6,130	
6N		1/8	Approx. 0.3	119	11,140	
6B		1/12	Approx. 0.3	167	15,320	
7SF	1024×768	1/2.7	Approx. 0.6	66	6,450	
7F		1/4	Approx. 0.4	96	9,430	
7N		1/8	Approx. 0.2	179	17,510	
7B		1/12	Approx. 0.2	251	24,520	
8SF	640×480	1/2.7	Approx. 0.3	157	15,320	
8F		1/4	Approx. 0.2	209	20,430	
8N		1/8	Approx. 0.1	359	30,650	
8B		1/12	Approx. 0.1	503	40,870	

*1 Assumes a 4GB SD card.

⚠ Cautions

- The number of remaining pictures may change according to the subject, whether or not print reservations have been made, and other factors. In certain instances, the number of remaining pictures displayed on the monitor will not change even when you take pictures or erase stored images.
- The actual file size varies according to the subject.
- The maximum number of storable still pictures displayed on the monitor is 9999.
- For the available recording time for movies, see the Olympus website.

Wireless remote control flash photography

External flash units that are designated for use with this camera and have a remote control mode can be used for wireless flash photography. See the instruction manuals provided with the external flash units for details.

- 1 Set the remote flash units to RC mode and place them as desired.
 - Turn each flash unit on, press the MODE button, and select RC mode.
 - Select a channel and group for each flash unit.
- 2 Select [**⚡** RC] for [Remote Flash] in **☰** shooting menu 2 (P. 40).
 - The commercially-available slave flash that is synchronized with the camera flash is used for taking pictures. The flash intensity setting can be adjusted.
 - Red-eye reduction is not available in RC mode.
 - After confirming that the built-in and remote flash units have charged, take a shot.

■ Wireless flash control range

Position the wireless flash units with their remote sensors facing the camera. The following illustration shows the approximate ranges at which the flash units can be positioned. The actual control range varies with local conditions.

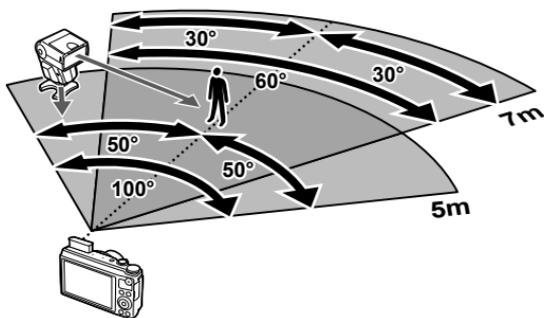

⚠ Cautions

- We recommend using up to 3 remote flash units.
- Remote flash units can not be used for second curtain slow synchronization longer than 4 seconds.
- If the subject is too close to the camera, the control flashes emitted by the built-in flash may affect exposure (this effect can be reduced by reducing the output of the built-in flash by, for example, using a diffuser).

Menu directory

*1: Can be added to [C Mode Setup].

*2: Default can be restored by selecting [Full] for [Reset].

*3: Default can be restored by selecting [Basic] for [Reset].

Shooting Menu 1 / Shooting Menu 2

Tab	Function		Default	*1	*2	*3	
	Card Setup		All Erase				40
	Backup		No				40
	Reset/C Mode Setup		—		✓		41
	Picture Mode		Natural	✓	✓	✓	42
		Still Picture	N	✓	✓	✓	43
		Movie	Full HD				
	Image Aspect		4:3	✓	✓	✓	44
	Lock		Off	✓	✓	✓	44
	Image Stabilizer		On	✓	✓	✓	32
	Bracketing		3f 0.3EV	✓	✓	✓	44
			±0.0	✓	✓	✓	36
	Remote Flash		Off	✓	✓	✓	75
	Sync		Sync 1	✓	✓	✓	45
	Super-Res Zoom		Off	✓	✓	✓	45
	Pic Orientation		On		✓	✓	45

Playback Menu

Tab	Function		Default	*1	*2	*3		
		Start	Start				28	
		BGM	Cosmic		✓	✓		
		Effect	Standard		✓	✓		
		Slide	All		✓	✓		
		Slide Interval	3sec		✓	✓		
		Movie Interval	Short		✓	✓		
	Edit	Sel. Image	RAW Data Edit	—				46
			JPEG Edit	—				46
				—				27
				—				59
Reset Protect		—					47	
Connection to Smartphone		—		✓			47	

Setup Menu

Tab	Function		Default	*1	*2	*3	
			—				49
	World Time		Home/Alternate	✓	✓	✓	
	*		—				
			±0, ±0, Vivid		✓	✓	
	Rec View		2sec	✓	✓	✓	
	Power On		Yes		✓	✓	

* Settings differ depending on the region where the camera is purchased.

✱ Custom Menu

Tab	Function	Default	*1	*2	*3		
✱	AF						
	AF Mode	Still Picture	S-AF	✓	✓	✓	51
	AF Area			✓	✓	✓	
	AF Illuminat.	On		✓	✓	✓	
	☉ Face Priority	Off		✓	✓		
	Button/dial						
	Fn Function		Off	✓	✓	✓	51
	Dial Function	P	:Ps	✓	✓		
		A	:FNo.				
		S	:Shutter				
		M	:Shutter :FNo.				
			:◀▶ :◀/Value				
		SCN	:Scene Mode				
		ART	:ART filter				
	Dial Direction	Exposure	↻	✓	✓		
		Menu	↻				
	Connection/Sound						
	HDMI	HDMI Out	1080i		✓		51
		HDMI Control	Off		✓		
Video Out*		—					
Beep Sound		3		✓	✓		
Volume		3		✓	✓		
USB Mode		Auto		✓	✓		
Display							
/Info Settings	Info	<input checked="" type="checkbox"/> Image Only		✓	✓		
		<input checked="" type="checkbox"/> Overall					
	<input type="checkbox"/> Highlight&Shadow						
LV-Info	<input checked="" type="checkbox"/>	✓	✓				
	<input type="checkbox"/> Highlight&Shadow						
Settings	<input type="checkbox"/>			✓			
	<input checked="" type="checkbox"/>						
Displayed Grid		Off		✓			
Control Settings	iAUTO	<input checked="" type="checkbox"/> Live Guide	✓	✓			
		<input type="checkbox"/> Live Control					
	P/A/S/M	<input checked="" type="checkbox"/> Live Control	✓	✓			
		<input type="checkbox"/> Live Control	✓	✓			
		ART				<input checked="" type="checkbox"/> Art Menu	
	<input type="checkbox"/> Live Control	✓	✓				
SCN	<input checked="" type="checkbox"/> Scene Menu	✓	✓				
	<input type="checkbox"/> Live Control						

Tab	Function	Default	*1	*2	*3		
	Picture Mode Settings	<input checked="" type="checkbox"/> Vivid				52	
		<input checked="" type="checkbox"/> Muted					
		<input checked="" type="checkbox"/> Portrait					
<input checked="" type="checkbox"/> Monotone							
<input checked="" type="checkbox"/> Soft Focus							
<input checked="" type="checkbox"/> Pale&Light Color							
<input checked="" type="checkbox"/> Light Tone							
<input checked="" type="checkbox"/> Grainy Film	✓	✓					
<input checked="" type="checkbox"/> Pin Hole							
<input checked="" type="checkbox"/> Diorama							
<input checked="" type="checkbox"/> Cross Process							
<input checked="" type="checkbox"/> Gentle Sepia							
<input checked="" type="checkbox"/> Dramatic Tone							
<input checked="" type="checkbox"/> Key Line							
	Live View Boost	Off	✓	✓	✓		
	Sleep	1 min	✓	✓	✓		
	Exp//ISO						
	Metering		✓	✓	✓	52	
	+Metering	Off	✓	✓	✓		
	Noise Reduct.	Auto	✓	✓	✓		
	Noise Filter	Standard	✓	✓	✓	53	
	ISO	Auto	✓	✓	✓		
	ISO-Auto Set	High Limit: 1600 Default: 100	✓	✓	✓		
	⚡ Custom						
	⚡ Slow Limit	1/30	✓	✓	✓	53	
	+	Off	✓	✓	✓		
	WB						
	WB	Auto	✓	✓	✓	53	
	Set	-1: F -2: N -3: N -4: N		✓	✓		
	Pixel Count	Middle	2560×1920	✓	✓		✓
		Small	1280×960				
	Record						
	File Name	Reset	✓	✓		54	
	Movie						
	Movie	On	✓	✓	✓	54	
	Wind Noise Reduction	Off	✓	✓	✓		
	Utility						
	Pixel Mapping	—				54	
	Touch Screen Settings	On		✓			
	Touch Calibration	—					
	Eye-Fi	—	✓				

* Settings differ depending on the region where the camera is purchased.

Specifications

Camera

Product type	
Product type	Compact digital camera
Image pickup device	
Product type	1/2.3" CMOS sensor
No. of effective pixels	Approx. 12,000,000 pixels
Aspect ratio	1.33 (4:3)
Monitor	
Product type	3.0" TFT color LCD display, touch screen
Total no. of pixels	Approx. 920,000 dots (aspect ratio 3:2)
Lens	
	Olympus lens 4.7 to 23.5 mm, f1.8 to 2.7 (Equivalent to 26 to 130 mm on a 35 mm film)
ND Filter	
	3 EV equivalent
Shutter	
Shutter speed	1/2000-30 sec.
Shooting range	
	0.1 m (4 inch) to ∞ (W), 0.3 m (1 ft.) to ∞ (T) (Normal/Macro) 0.01 m (0.4 inch) to 0.6 m (2 ft.) (super macro mode)
Auto focus	
Product type	Imager contrast detection system
Focusing points	Maximum of 35 points
Exposure control	
Metering system	TTL metering system (imager metering) ESP metering/Center weighted averaging metering/Spot metering/ Selected target metering
Metered range	EV-3-17 (ESP metering/Center weighted averaging metering/Spot metering)
ISO sensitivity	100-6400 (1/3 EV step)
Exposure compensation	±3EV (1/3 EV step)
White balance	
Mode setting	Auto/Preset WB (7 settings)/Customized WB/One-touch WB
Recording	
Memory	Built-in memory, SD/SDHC/SDXC (supports UHS-I), Eye-Fi card, FlashAir (wireless LAN mounted) card
Recording system	Digital recording, JPEG (in accordance with Design rule for Camera File system (DCF)), RAW Data
Applicable standards	Exif 2.2, Digital Print Order Format (DPOF), PRINT Image Matching III, PictBridge
Sound with still pictures	Wave format
Movie	MOV(MPEG-4 AVC/H.264)
Audio	PCM 48kHz

Playback	
Display format	Single-frame playback/Close-up playback/Index display
External connector	
	Multi-connector (USB connector, AV connector)/ HDMI micro connector (Type D)
Power supply	
Battery	One Olympus lithium ion battery (LI-50B) or separately sold USB-AC adapter
Dimensions/weight	
Dimensions	102.4 mm (W) × 61.1 mm (H) × 34.3 mm (D) (4.0" × 2.4" × 1.4") (excluding protrusions)
Weight	Approx. 221 g (7.7 oz.) (including battery and memory card)
Operating environment	
Temperature	0 °C - 40 °C (32 °F - 104 °F) (operation)/ -20 °C - 60 °C (-4 °F - 140 °F) (storage)
Humidity	30% - 90% (operation)/10% - 90% (storage)

■ Lithium ion battery

MODEL NO.	LI-50B
Product type	Rechargeable Lithium ion battery
Nominal voltage	DC 3.7 V
Nominal capacity	925 mAh
No. of charge and discharge times	Approx. 300 times (varies with usage conditions)
Usage environment	Temperature: 0 °C - 40 °C (32 °F - 104 °F) (charging)

■ USB-AC adapter

MODEL NO.	F-2AC-1B/F-2AC-2B
Rated input	AC 100 V - 240 V (50/60 Hz)
Rated output	DC 5V, 500mA
Usage environment	Temperature: 0 °C - 40 °C (32 °F - 104 °F) (operation)/ -20 °C - 60 °C (-4 °F - 140 °F) (storage)

SPECIFICATIONS ARE SUBJECT TO CHANGE WITHOUT ANY NOTICE OR OBLIGATION ON THE PART OF THE MANUFACTURER.

HDMI, the HDMI logo and High-Definition Multimedia Interface are trademarks or registered trademarks of HDMI Licensing LLC.

HDMI™
HIGH-DEFINITION MULTIMEDIA INTERFACE

SAFETY PRECAUTIONS

	CAUTION RISK OF ELECTRIC SHOCK DO NOT OPEN	
<p>CAUTION: TO REDUCE THE RISK OF ELECTRICAL SHOCK, DO NOT REMOVE COVER (OR BACK). NO USER-SERVICEABLE PARTS INSIDE. REFER SERVICING TO QUALIFIED OLYMPUS SERVICE PERSONNEL.</p>		

 An exclamation mark enclosed in a triangle alerts you to important operating and maintenance instructions in the documentation provided with the product.

 **DANGER** If the product is used without observing the information given under this symbol, serious injury or death may result.

 **WARNING** If the product is used without observing the information given under this symbol, injury or death may result.

 **CAUTION** If the product is used without observing the information given under this symbol, minor personal injury, damage to the equipment, or loss of valuable data may result.

WARNING!
TO AVOID THE RISK OF FIRE OR ELECTRICAL SHOCK, NEVER DISASSEMBLE, EXPOSE THIS PRODUCT TO WATER OR OPERATE IN A HIGH HUMIDITY ENVIRONMENT.

General Precautions

Read All Instructions — Before you use the product, read all operating instructions. Save all manuals and documentation for future reference.

Cleaning — Always unplug this product from the wall outlet before cleaning. Use only a damp cloth for cleaning. Never use any type of liquid or aerosol cleaner, or any type of organic solvent to clean this product.

Attachments — For your safety, and to avoid damaging the product, use only accessories recommended by Olympus.

Water and Moisture — For precautions on products with weatherproof designs, read the weatherproofing sections.

Location — To avoid damage to the product, mount the product securely on a stable tripod, stand, or bracket.

Power Source — Connect this product only to the power source described on the product label.

Lightning — If a lightning storm occurs while using a USB-AC adapter, remove it from the wall outlet immediately.

Foreign Objects — To avoid personal injury, never insert a metal object into the product.

Heat — Never use or store this product near any heat source such as a radiator, heat register, stove, or any type of equipment or appliance that generates heat, including stereo amplifiers.

Handling the Camera

WARNING

- Do not use the camera near flammable or explosive gases.
 - Do not use the flash and LED (including AF illuminator) on people (infants, small children, etc.) at close range.
 - You must be at least 1 m (3 ft.) away from the faces of your subjects. Firing the flash too close to the subject's eyes could cause a momentary loss of vision.
 - Keep young children, infants and pet animals away from the camera.
 - Always use and store the camera out of the reach of young children, infants and pet animals to prevent the following dangerous situations which could cause serious injury:
 - Becoming entangled in the camera strap, causing strangulation.
 - Accidentally swallowing the battery, cards or other small parts.
 - Accidentally firing the flash into their own eyes or those of another child.
 - Accidentally being injured by the moving parts of the camera.
 - Do not look at the sun or strong lights with the camera.
 - Do not use or store the camera in dusty or humid places.
 - Do not cover the flash with a hand while firing.
 - Use SD/SDHC/SDXC memory cards or Eye-Fi cards only. Never use other types of cards.
- If you accidentally insert another type of card into the camera, contact an authorized distributor or service center. Do not try to remove the card by force.
- If you find that the USB-AC adapter is extremely hot or notice any unusual odors, noise, or smoke around it, unplug the power plug from wall outlet immediately and stop using it. Then, contact an authorized distributor or service center.

CAUTION

- Stop using the camera immediately if you notice any unusual odors, noise, or smoke around it.
- Never remove the batteries with bare hands, which may cause a fire or burn your hands.
- Never hold or operate the camera with wet hands.
- Do not leave the camera in places where it may be subject to extremely high temperatures.
- Doing so may cause parts to deteriorate and, in some circumstances, cause the camera to catch fire. Do not use the USB-AC adapter if it is covered (such as a blanket). This could cause overheating, resulting in fire.
- Handle the camera with care to avoid getting a low-temperature burn.
- When the camera contains metal parts, overheating can result in a low-temperature burn. Pay attention to the following:
 - When used for a long period, the camera will get hot. If you hold on to the camera in this state, a low-temperature burn may be caused.
 - In places subject to extremely cold temperatures, the temperature of the camera's body may be lower than the environmental temperature. If possible, wear gloves when handling the camera in cold temperatures.

- **Be careful with the strap.**
- Be careful with the strap when you carry the camera. It could easily catch on stray objects and cause serious damage.
- To protect the high-precision technology contained in this product, never leave the camera in the places listed below, no matter if in use or storage:
 - Places where temperatures and/or humidity are high or go through extreme changes. Direct sunlight, beaches, locked cars, or near other heat sources (stove, radiator, etc.) or humidifiers.
 - In sandy or dusty environments.
 - Near flammable items or explosives.
 - In wet places, such as bathrooms or in the rain. When using products with weatherproof designs, read their manuals as well.
 - In places prone to strong vibrations.
- Never drop the camera or subject it to severe shocks or vibrations.
- When attaching the camera to or removing it from a tripod, rotate the tripod screw, not the camera.
- Before transporting the camera, remove a tripod and all other non-OLYMPUS accessories.
- Do not touch electric contacts on cameras.
- Do not leave the camera pointed directly at the sun. This may cause lens or shutter curtain damage, color failure, ghosting on the image pickup device, or may possibly cause fires.
- Do not push or pull severely on the lens.
- Before storing the camera for a long period, remove the batteries. Select a cool, dry location for storage to prevent condensation or mold from forming inside the camera. After storage, test the camera by turning it on and pressing the shutter button to make sure that it is operating normally.
- The camera may malfunction if it is used in a location where it is subject to a magnetic/electromagnetic field, radio waves, or high voltage, such as near a TV set, microwave, video game, loud speakers, large monitor unit, TV/radio tower, or transmission towers. In such cases, turn the camera off and remove the battery, then reinsert it and turn the camera on again before further operation.
- Always observe the operating environment restrictions described in the camera's manual.

Battery Handling Precautions

Follow these important guidelines to prevent batteries from leaking, overheating, burning, exploding, or causing electrical shocks or burns.

DANGER

- The camera uses a lithium ion battery specified by Olympus. Charge the battery with the specified USB-AC adapter or charger. Do not use any other USB-AC adapters or chargers.
 - Never heat or incinerate batteries.
 - Take precautions when carrying or storing batteries to prevent them from coming into contact with any metal objects such as jewelry, pins, fasteners, etc.
 - Never store batteries where they will be exposed to direct sunlight, or subjected to high temperatures in a hot vehicle, near a heat source, etc.
 - To prevent causing battery leaks or damaging their terminals, carefully follow all instructions regarding the use of batteries. Never attempt to disassemble a battery or modify it in any way, solder, etc.
 - If battery fluid gets into your eyes, flush your eyes immediately with clear, cold running water and seek medical attention immediately.
 - Always store batteries out of the reach of small children. If a child accidentally swallows a battery, seek medical attention immediately.
- If you cannot remove the battery from the camera, contact an authorized distributor or service center. Do not try to remove the battery by force. Damage to the battery exterior (scratches, etc.) may produce heat or an explosion.

WARNING

- Keep batteries dry at all times.
- To prevent batteries from leaking, overheating, or causing a fire or explosion, use only batteries recommended for use with this product.
- Insert the battery carefully as described in the operating instructions.
- If rechargeable batteries have not been recharged within the specified time, stop charging them and do not use them.
- Do not use a battery if it is cracked or broken.
- If a battery leaks, becomes discolored or deformed, or becomes abnormal in any other way during operation, stop using the camera.
- If a battery leaks fluid onto your clothing or skin, remove the clothing and flush the affected area with clean, running cold water immediately. If the fluid burns your skin, seek medical attention immediately.
- Never subject batteries to strong shocks or continuous vibration.

CAUTION

- Before loading, always inspect the battery carefully for leaks, discoloration, warping, or any other abnormality.
- The battery may become hot during prolonged use. To avoid minor burns, do not remove it immediately after using the camera.
- Always unload the battery from the camera before storing the camera for a long period.
- This camera uses one Olympus lithium ion battery. Use the specified genuine battery. There is a risk of explosion if the battery is replaced with a non-specified.
- Power consumption by the camera varies depending on which functions are used.
- During the conditions described below, power is consumed continuously and the battery becomes exhausted quickly.
 - The zoom is used repeatedly.
 - The shutter button is pressed halfway repeatedly in shooting mode, activating the auto focus.
 - A picture is displayed on the monitor for an extended period of time.
 - The camera is connected to a printer.
- Using an exhausted battery may cause the camera to turn off without displaying the battery level warning.
- The Olympus lithium ion battery is designed to be used only for the Olympus digital camera. Do not use the battery to other devices.
- If the battery's terminals get wet or greasy, camera contact failure may result. Wipe the battery well with a dry cloth before use.
- Always charge a battery when using it for the first time, or if it has not been used for a long period.
- When operating the camera with battery power at low temperatures, try to keep the camera and spare battery as warm as possible. A battery that has run down at low temperatures may be restored after it is warmed at room temperature.
- Before going on a long trip, and especially before traveling abroad, purchase extra batteries. A recommended battery may be difficult to obtain while traveling.
- When storing the battery for a long period, select a cool location for storage.
- Please recycle batteries to help save our planet's resources. When you throw away dead batteries, be sure to cover their terminals and always observe local laws and regulations.

USB-AC adapter

- The included USB-AC adapter F-2AC is designed to be used only with this camera. Other cameras cannot be charged with this USB-AC adapter.
- Do not connect the included USB-AC adapter F-2AC to equipment other than this camera.
- For plug-in type USB-AC adapter:
The included USB-AC adapter F-2AC is intended to be correctly orientated in a vertical or floor mount position.

Use Only Dedicated Rechargeable Battery, Battery Charger and USB-AC adapter

- We strongly recommend that you use only the genuine Olympus dedicated rechargeable battery, battery charger and USB-AC adapter with this camera. Using a non-genuine rechargeable battery, battery charger and/or USB-AC adapter may result in fire or personal injury due to leakage, heating, ignition or damage to the battery. Olympus does not assume any liability for accidents or damage that may result from the use of a battery, battery charger and/or USB-AC adapter that are not genuine Olympus accessories.

Monitor

- Do not push the monitor forcibly; otherwise the image may become vague, resulting in a playback mode failure or damage to the monitor.
- A strip of light may appear on the top/bottom of the monitor, but this is not a malfunction.
- When a subject is viewed diagonally in the camera, the edges may appear zigzagged on the monitor. This is not a malfunction; it will be less noticeable in playback mode.
- In places subject to low temperatures, the monitor may take a long time to turn on or its color may change temporarily. When using the camera in extremely cold places, it is a good idea to occasionally place it in a warm place. The monitor exhibiting poor performance due to low temperatures will recover in normal temperatures.
- The monitor of this product is manufactured with high-quality accuracy, however, there may be a stuck or dead pixel on the monitor. These pixels do not have any influence on the image to be saved. Because of the characteristics, the unevenness of the color or brightness may also be found depending on the angle, but this is due to the structure of the monitor. This is not a malfunction.

Legal and Other Notices

- Olympus makes no representations or warranties regarding any damages, or benefit expected by using this unit lawfully, or any request from a third person, which are caused by the inappropriate use of this product.
- Olympus makes no representations or warranties regarding any damages or any benefit expected by using this unit lawfully which are caused by erasing picture data.

Disclaimer of Warranty

- Olympus makes no representations or warranties, either expressed or implied, by or concerning any content of these written materials or software, and in no event shall be liable for any implied warranty of merchantability or fitness for any particular purpose or for any consequential, incidental or indirect damages (including but not limited to damages for loss of business profits, business interruption and loss of business information) arising from the use or inability to use these written materials or software or equipment. Some countries do not allow the exclusion or limitation of liability for consequential or incidental damages or of the implied warranty, so the above limitations may not apply to you.
- Olympus reserves all rights to this manual.

Warning

Unauthorized photographing or use of copyrighted material may violate applicable copyright laws. Olympus assumes no responsibility for unauthorized photographing, use or other acts that infringe upon the rights of copyright owners.

Copyright Notice

All rights reserved. No part of these written materials or this software may be reproduced or used in any form or by any means, electronic or mechanical, including photocopying and recording or the use of any type of information storage and retrieval system, without the prior written permission of Olympus. No liability is assumed with respect to the use of the information contained in these written materials or software, or for damages resulting from the use of the information contained therein. Olympus reserves the right to alter the features and contents of this publication or software without obligation or advance notice.

FCC Notice

- Radio and Television Interference
- Changes or modifications not expressly approved by the manufacturer may void the user's authority to operate this equipment. This equipment has been tested and found to comply with the limits for a Class B digital device, pursuant to Part 15 of the FCC Rules. These limits are designed to provide reasonable protection against harmful interference in a residential installation.
- This equipment generates, uses, and can radiate radio frequency energy and, if not installed and used in accordance with the instructions, may cause harmful interference to radio communications.
- However, there is no guarantee that interference will not occur in a particular installation. If this equipment does cause harmful interference to radio or television reception, which can be determined by turning the equipment off and on, the user is encouraged to try to correct the interference by one or more of the following measures:
 - Adjust or relocate the receiving antenna.
 - Increase the distance between the camera and receiver.
 - Connect the equipment to an outlet on a circuit different from that to which the receiver is connected.
 - Consult your dealer or an experienced radio/TV technician for help. Only the OLYMPUS-supplied USB cable should be used to connect the camera to USB enabled personal computers (PC).

Any unauthorized changes or modifications to this equipment would void the user's authority to operate it.

For customers in North and South America

For customers in USA

Declaration of Conformity

Model Number: XZ-10

Trade Name: OLYMPUS

Responsible Party:

OLYMPUS IMAGING AMERICA INC.

Address: 3500 Corporate Parkway, P.O. Box 610,
Center Valley, PA 18034-0610, U.S.A.

Telephone Number: 484-896-5000

Tested To Comply With FCC Standards
FOR HOME OR OFFICE USE

This device complies with Part 15 of the FCC rules. Operation is subject to the following two conditions:

- (1) This device may not cause harmful interference.
- (2) This device must accept any interference received, including interference that may cause undesired operation.

For customers in CANADA

This Class B digital apparatus complies with Canadian ICES-003.

OLYMPUS WORLDWIDE LIMITED WARRANTY - IMAGING PRODUCTS

Olympus warrants that the enclosed Olympus® imaging product(s) and related Olympus® accessories (individually a "Product" and collectively the "Products") will be free from defects in materials and workmanship under normal use and service for a period of one (1) year from the date of purchase.

If any Product proves to be defective within the one-year warranty period, the customer must return the defective Product to any of Olympus Service Centers, following the procedure set forth below (See "WHAT TO DO WHEN SERVICE IS NEEDED").

Olympus, at its sole discretion, will repair, replace, or adjust the defective Product, provided that Olympus investigation and factory inspection disclose that (a) such defect developed under normal and proper use and (b) the Product is covered under this limited warranty.

Repair, replacement, or adjustment of defective Products shall be Olympus's sole obligation and the customer's sole remedy hereunder.

The customer is liable and shall pay for shipment of the Products to the Olympus Service Center.

Olympus shall not be obligated to perform preventive maintenance, installation, deinstallation, or maintenance.

Olympus reserves the right to (i) use reconditioned, refurbished, and/or serviceable used parts (that meet Olympus's quality assurance standards) for warranty or any other repairs and (ii) make any internal or external design and/or feature changes on or to its products without any liability to incorporate such changes on or to the Products.

WHAT IS NOT COVERED BY THIS LIMITED WARRANTY

Excluded from this limited warranty and not warranted by Olympus in any fashion, either express, implied, or by statute, are:

- (a) products and accessories not manufactured by Olympus and/or not bearing the "OLYMPUS" brand label (the warranty coverage for products and accessories of other manufacturers, which may be distributed by Olympus, is the responsibility of the manufacturers of such products and accessories in accordance with the terms and duration of such manufacturers' warranties);
- (b) any Product which has been disassembled, repaired, tampered with, altered, changed, or modified by persons other than Olympus's own authorized service personnel unless repair by others is made with the written consent of Olympus;
- (c) defects or damage to the Products resulting from wear, tear, misuse, abuse, negligence, sand, liquids, impact, improper storage, nonperformance of scheduled operator and maintenance items, battery leakage, use of non-"OLYMPUS" brand accessories, consumables, or supplies, or use of the Products in combination with non-compatible devices;
- (d) software programs;
- (e) supplies and consumables (including but not limited to lamps, ink, paper, film, prints, negatives, cables and batteries); and/or
- (f) Products which do not contain a validly placed and recorded Olympus serial number, unless they are a model on which Olympus does not place and record serial numbers.

EXCEPT FOR THE LIMITED WARRANTY SET FORTH ABOVE, OLYMPUS MAKES NO AND DISCLAIMS ALL OTHER REPRESENTATIONS, GUARANTIES, CONDITIONS, AND WARRANTIES CONCERNING THE PRODUCTS, WHETHER DIRECT OR INDIRECT, EXPRESS OR IMPLIED, OR ARISING UNDER ANY STATUTE, ORDINANCE, COMMERCIAL USAGE OR OTHERWISE, INCLUDING BUT NOT LIMITED TO ANY WARRANTY OR REPRESENTATION AS TO THE SUITABILITY, DURABILITY, DESIGN, OPERATION, OR CONDITION OF THE PRODUCTS (OR ANY PART THEREOF) OR THE MERCHANTABILITY OF THE PRODUCTS OR THEIR FITNESS FOR A PARTICULAR PURPOSE, OR RELATING TO THE INFRINGEMENT OF ANY PATENT, COPYRIGHT, OR OTHER PROPRIETARY RIGHT USED OR INCLUDED THEREIN.

IF ANY IMPLIED WARRANTIES APPLY AS A MATTER OF LAW, THEY ARE LIMITED IN DURATION TO THE LENGTH OF THIS LIMITED WARRANTY.

SOME STATES MAY NOT RECOGNIZE A DISCLAIMER OR LIMITATION OF WARRANTIES AND/OR LIMITATION OF LIABILITY SO THE ABOVE DISCLAIMERS AND EXCLUSIONS MAY NOT APPLY.

THE CUSTOMER MAY ALSO HAVE DIFFERENT AND/OR ADDITIONAL RIGHTS AND REMEDIES THAT VARY FROM STATE TO STATE.

THE CUSTOMER ACKNOWLEDGES AND AGREES THAT OLYMPUS SHALL NOT BE RESPONSIBLE FOR ANY DAMAGES THAT THE CUSTOMER MAY INCUR FROM DELAYED SHIPMENT, PRODUCT FAILURE, PRODUCT DESIGN, SELECTION, OR PRODUCTION, IMAGE OR DATA LOSS OR IMPAIRMENT OR FROM ANY OTHER CAUSE, WHETHER LIABILITY IS ASSERTED IN CONTRACT, TORT (INCLUDING NEGLIGENCE AND STRICT PRODUCT LIABILITY) OR OTHERWISE. IN NO EVENT SHALL OLYMPUS BE LIABLE FOR ANY INDIRECT, INCIDENTAL, CONSEQUENTIAL OR SPECIAL DAMAGES OF ANY KIND (INCLUDING WITHOUT LIMITATION LOSS OF PROFITS OR LOSS OF USE), WHETHER OR NOT OLYMPUS SHALL BE OR SHOULD BE AWARE OF THE POSSIBILITY OF SUCH POTENTIAL LOSS OR DAMAGE.

Representations and warranties made by any person, including but not limited to dealers, representatives, salespersons, or agents of Olympus, which are inconsistent or in conflict with or in addition to the terms of this limited warranty, shall not be binding upon Olympus unless reduced to writing and approved by an expressly authorized officer of Olympus.

This limited warranty is the complete and exclusive statement of warranty which Olympus agrees to provide with respect to the Products and it shall supersede all prior and contemporaneous oral or written agreements, understandings, proposals, and communications pertaining to the subject matter hereof.

This limited warranty is exclusively for the benefit of the original customer and cannot be transferred or assigned.

WHAT TO DO WHEN SERVICE IS NEEDED

The customer must transfer any image or other data saved on a Product to another image or data storage medium and/or remove any film from the Product prior to sending the Product to Olympus for service.

IN NO EVENT SHALL OLYMPUS BE RESPONSIBLE FOR SAVING, KEEPING OR MAINTAINING ANY IMAGE OR DATA SAVED ON A PRODUCT RECEIVED BY IT FOR SERVICE, OR ON ANY FILM CONTAINED WITHIN A PRODUCT RECEIVED BY IT FOR SERVICE. NOR SHALL OLYMPUS BE RESPONSIBLE FOR ANY DAMAGES IN THE EVENT ANY IMAGE OR DATA IS LOST OR IMPAIRED WHILE SERVICE IS BEING PERFORMED (INCLUDING, WITHOUT LIMITATION, DIRECT, INDIRECT, INCIDENTAL, CONSEQUENTIAL OR SPECIAL DAMAGES, LOSS OF PROFITS OR LOSS OF USE), WHETHER OR NOT OLYMPUS SHALL BE OR SHOULD BE AWARE OF THE POSSIBILITY OF SUCH POTENTIAL LOSS OR IMPAIRMENT.

Package the Product carefully using ample padding material to prevent damage in transit and either deliver it to the Authorized Olympus Dealer that sold you the Product or ship it postage prepaid and insured to any of our Olympus Service Centers.

When returning Products for service, your package should include the following:

- 1 Sales receipt showing date and place of purchase.
- 2 Copy of this limited warranty **bearing the Product serial number corresponding to the serial number on the Product** (unless it is a model on which Olympus does not place and record serial numbers).
- 3 A detailed description of the problem.
- 4 Sample prints, negatives, digital prints (or files on disk) if available and related to the problem.

When service is completed, the Product will be returned to you postage prepaid.

WHERE TO SEND PRODUCT FOR SERVICE

See "WORLDWIDE WARRANTY" for the nearest service center.

INTERNATIONAL WARRANTY SERVICE

International warranty service is available under this warranty.

For customers in Europe



"CE" mark indicates that this product complies with the European requirements for safety, health, environment and customer protection. "CE" mark cameras are intended for sales in Europe.



This symbol [crossed-out wheeled bin WEEE Annex IV] indicates separate collection of waste electrical and electronic equipment in the EU countries.

Please do not throw the equipment into the domestic refuse.

Please use the return and collection systems available in your country for the disposal of this product.



This symbol [crossed-out wheeled bin Directive 2006/66/EC Annex II] indicates separate collection of waste batteries in the EU countries.

Please do not throw the batteries into the domestic refuse. Please use the return and collection systems available in your country for the disposal of the waste batteries.

Provisions of warranty

- 1 If this product proves to be defective, although it has been used properly (in accordance with the written Handling Care and Operating instructions supplied with it), during the applicable national warranty period and has been purchased from an authorized Olympus distributor within the business area of Olympus Europa Holding GmbH as stipulated on the website: <http://www.olympus.com> this product will be repaired, or at Olympus's option replaced, free of charge. To claim under this warranty the customer must take the product before the end of the applicable national warranty period to the dealer where the product was purchased or any other Olympus service station within the business area of Olympus Europa Holding GmbH as stipulated on the website: <http://www.olympus.com>. During the one year period of the World Wide Guarantee the customer may turn the product in at any Olympus service station. Please notice that not in all countries such Olympus service station exists.
- 2 The customer shall transport the product to the dealer or Olympus authorized service station at his own risk and shall be responsible for any costs incurred in transporting the product.

Provisions of Guarantee

- 1 "OLYMPUS IMAGING CORP., 2951 Ishikawa-machi, Hachioji-shi, Tokyo 192-8507, Japan grants a one year World Wide Guarantee. This worldwide Guarantee must be presented at an Olympus authorized repair service station before any repair can be made under conditions of this Guarantee. This Guarantee is valid only if the Guarantee Certificate and proof of purchase are presented at the Olympus repair service station. Please note that this Guarantee is in addition to and does not affect the customer's legal warranty rights under the applicable national legislation governing the sale of consumer goods mentioned above.

- 2 This Guarantee does not cover the following and the customer will be required to pay repair charge, even for defects occurring within the Guarantee period referred to above.
- Any defect that occurs due to mishandling (such as an operation performed that is not mentioned in the Handling Care or other sections of the instructions, etc.)
 - Any defect that occurs due to repair, modification, cleaning, etc. performed by anyone other than Olympus or an Olympus authorized service station.
 - Any defect or damage that occurs due to transport, a fall, shock, etc. after purchase of the product.
 - Any defect or damage that occurs due to fire, earthquake, flood damage, thunderbolt, other natural disasters, environmental pollution and irregular voltage sources.
 - Any defect that occurs due to careless or improper storage (such as keeping the product under conditions of high temperature and humidity, near insect repellents such as naphthalene or harmful drugs, etc.), improper maintenance, etc.
 - Any defect that occurs due to exhausted batteries, etc.
 - Any defect that occurs due to sand, mud, etc. entering the inside of the product casing.
 - When the Guarantee Certificate is not returned with the product.
 - When any alterations whatsoever are made to the Guarantee Certificate regarding the year, month and date of purchase, the customer's name, the dealer's name, and the serial number.
 - When proof of purchase is not presented with this Guarantee Certificate.
- 3 This Guarantee applies to the product only; the Guarantee does not apply to any other accessory equipment, such as the case, strap, lens cap and batteries.
- 4 Olympus's sole liability under this Guarantee shall be limited to repairing or replacing the product. Any liability under the Guarantee for indirect or consequential loss or damage of any kind incurred or suffered by the customer due to a defect of the product, and in particular any loss or damage caused to any lenses, films, other equipment or accessories used with the product or for any loss resulting from a delay in repair or loss of data, is excluded. Compelling regulations by law remain unaffected by this.

Notes regarding Guarantee maintenance

- 1 This Guarantee will only be valid if the Guarantee Certificate is duly completed by Olympus or an authorized dealer or other documents contain sufficient proof. Therefore, please make sure that your name, the name of the dealer, the serial number and the year, month and date of purchase are all completed or the original invoice or the sales receipt (indicating the dealer's name, the date of purchase and product type) is attached to this Guarantee Certificate. Olympus reserves the right to refuse free-of-charge service if neither Guarantee Certificate is completed nor the above document is attached or if the information contained in it is incomplete or illegible.
- 2 Since this Guarantee Certificate will not be re-issued, keep it in a safe place.
- * Please refer to the list on the web site: <http://www.olympus.com> for the authorized international Olympus service network.

For customers in Asia

Provisions of warranty

- 1 If this product proves to be defective, although it has been used properly (in accordance with the written Handling Care and Operating instructions supplied with it), during a period of up to one year from the date of purchase this product will be repaired, or at Olympus's option replaced, free of charge. To claim under warranty the customer must take the product and this Warranty certificate before the end of the one year warranty period to the dealer where the product was purchased or any Olympus authorized service station listed in the instructions and request the necessary repairs.
- 2 The customer shall transport the product to the dealer or Olympus authorized service station at his own risk and shall be responsible for any costs incurred in transporting the product.
- 3 This warranty does not cover the following and the customer will be required to pay repair charge, even for defects occurring within the one year period referred to above.
- Any defect that occurs due to mishandling (such as an operation performed that is not mentioned in the Handling Care or other sections of the instructions, etc.)
 - Any defect that occurs due to repair, modification, cleaning, etc. performed by anyone other than Olympus or an Olympus authorized service station.
 - Any defect or damage that occurs due to transport, a fall, shock, etc. after purchase of the product.
 - Any defect or damage that occurs due to fire, earthquake, flood damage, thunderbolt, other natural disasters, environmental pollution and irregular voltage sources.
 - Any defect that occurs due to careless or improper storage (such as keeping the product under conditions of high temperature and humidity, near insect repellents such as naphthalene or harmful drugs, etc.), improper maintenance, etc.
 - Any defect that occurs due to exhausted batteries, etc.
 - Any defect that occurs due to sand, mud, etc. entering the inside of the product casing.
 - When this Warranty Certificate is not returned with the product.
 - When any alterations whatsoever are made to the Warranty Certificate regarding the year, month and date of purchase, the customer's name, the dealer's name, and the serial number.
 - When proof of purchase is not presented with this Warranty Certificate.
- 4 This Warranty applies to the product only; the Warranty does not apply to any other accessory equipment, such as the case, strap, lens cap and batteries.
- 5 Olympus's sole liability under this warranty shall be limited to repairing or replacing the product and any liability for indirect or consequential loss or damage of any kind incurred or suffered by the customer due to a defect in the product, and in particular any loss or damage caused to any film or lenses or other equipment or accessories used with the product or for any loss resulting from delay in repair, is excluded.

Notes;

- 1 This Warranty is in addition to and does not affect the customer's statutory right.
- 2 If you have any queries regarding this Warranty, call any of the Olympus authorized service stations listed in the instructions.

Notes regarding warranty maintenance

- 1 This Warranty will only be valid if the Warranty Certificate is duly completed by Olympus or the dealer. Make sure that your name, the name of the dealer, the serial number and the year, month and date of purchase are all completed.
- 2 Since this Warranty Certificate will not be re-issued, keep it in a safe place.
- 3 Any request for repair by a customer in same country where the product was purchased shall be subject to the terms of the warranty issued by the Olympus distributor in that country. Where the local Olympus distributor does not issue a separate warranty or where the customer is not in the country where the product was purchased the terms of this worldwide warranty shall apply.
- 4 Where applicable, this Warranty is valid worldwide. The Olympus authorized service stations listed in this Warranty will gladly honor it.
 - * Please refer to the appended list for the authorized international Olympus service network.

Disclaimer of Warranty

Olympus makes no representations or warranties, either expressed or implied, by or concerning any content if these written materials or software, and in no event shall be liable for any implied warranty of merchantability or fitness for any particular purpose or for any consequential, incidental or indirect damages (including but not limited to damages for loss of business profits, business interruption and loss of business information) arising from the use of inability to use these written materials or software. Some states do not allow the exclusion or limitation of liability for consequential or incidental damages, so the above limitations may not apply to you.

Trademarks

- Microsoft and Windows are registered trademarks of Microsoft Corporation.
- Macintosh is a trademark of Apple Inc.
- SDXC logo is a trademark of SD-3C, LLC.
- Eye-Fi is a registered trademark of Eye-Fi, Inc.
- FlashAir is a trademark of Toshiba Corporation.
- Powered by ARCSOFT.
- All other company and product names are registered trademarks and/or trademarks of their respective owners.

THIS PRODUCT IS LICENSED UNDER THE AVC PATENT PORTFOLIO LICENSE FOR THE PERSONAL AND NONCOMMERCIAL USE OF A CONSUMER TO (i) ENCODE VIDEO IN COMPLIANCE WITH THE AVC STANDARD ("AVC VIDEO") AND/OR (ii) DECODE AVC VIDEO THAT WAS ENCODED BY A CONSUMER ENGAGED IN A PERSONAL AND NON-COMMERCIAL ACTIVITY AND/OR WAS OBTAINED FROM A VIDEO PROVIDER LICENSED TO PROVIDE AVC VIDEO. NO LICENSE IS GRANTED OR SHALL BE IMPLIED FOR ANY OTHER USE. ADDITIONAL INFORMATION MAY BE OBTAINED FROM MPEG LA, L.L.C. SEE [HTTP://WWW.MPEGLA.COM](http://WWW.MPEGLA.COM)

The software in this camera may include third party software. Any third party software is subject to the terms and conditions, imposed by the owners or licensors of that software, under which software is provided to you.

Those terms and other third party software notices, if any, may be found in the software notice PDF file stored within the accompanying CD-ROM or at <http://www.olympus.co.jp/en/support/msgs/digicamera/download/notice/notice.cfm>

- The standards for camera file systems referred to in this manual are the "Design rule for Camera File system/DCF" standards stipulated by the Japan Electronics and Information Technology Industries Association (JEITA).

OLYMPUS KOREA CO., LTD.

10F, Olympus Tower A, 114-9, Samsung-dong, Gangnam-gu, Seoul, Korea. 135-090
<http://www.olympus.co.kr> Tel. 1544-3200

OLYMPUS (MALAYSIA) Sdn Bhd

10-8, Menara 1 MK, Kompleks '1 Mont Kiara', No.1, Jalan Kiara, Mont Kiara, 50480
Kuala Lumpur, Malaysia.
Tel:+603-6411 0000/Fax:+603-6411 0003

BRANCHES:

PENANG OFFICE

Suite 3A-6, Level 3A, Wisma Great Eastern
No.25, Lebu Light, 10200 Penang
Tel:+604 262 2832/ Fax:+604 262 5832

KUCHING OFFICE

Level 6-5A, 6th Floor Menara MAA,
Lot 86, Section 53,
Jalan Central Timur,
93300 Kuching, Sarawak
Tel:+6082 253 885/ Fax:+6082 256 885

<http://www.olympus.com.my>

OLYMPUS

<http://www.olympus.com/>

OLYMPUS IMAGING CORP.

2951 Ishikawa-machi, Hachioji-shi, Tokyo, Japan

OLYMPUS IMAGING AMERICA INC.

3500 Corporate Parkway, P.O. Box 610, Center Valley, PA 18034-0610, U.S.A. Tel. 484-896-5000

Technical Support (USA)

24/7 online automated help:

<http://www.olympusamerica.com/support>

Phone customer support: Tel. 1-888-553-4448 (Toll-free)

Our phone customer support is available from 9 am to 9 pm (Monday to Friday) ET

<http://olympusamerica.com/contactus>

Olympus software updates can be obtained at:

<http://www.olympusamerica.com/digital>

OLYMPUS EUROPA HOLDING GMBH

Premises: Wendenstrasse 14-18, 20097 Hamburg, Germany

Tel: +49 40-23 77 3-0 / Fax: +49 40-23 07 61

Goods delivery: Modul H, Willi-Bleicher Str. 36, 52353 Düren, Germany

Letters: Postfach 10 49 08, 20034 Hamburg, Germany

European Technical Customer Support:

Please visit our homepage <http://www.olympus-europa.com> or call our TOLL FREE NUMBER* : **00800 - 67 10 83 00**

for Austria, Belgium, Denmark, Finland, France, Germany, Italy, Luxemburg, Netherlands, Norway, Portugal, Spain, Sweden, Switzerland, United Kingdom

* Please note some (mobile) phone services providers do not permit access or request an additional prefix to +800 numbers.

For all European Countries not listed and in case that you can't get connected to the above mentioned number, please make use of the following CHARGED NUMBERS: **+49 180 5 - 67 10 83** or **+49 40 - 237 73 4899**

Our Technical Customer Support is available from 9 am to 6 pm MET (Monday to Friday)

OLYMPUS IMAGING CHINA CO.,LTD.

Customer Support: 400-650-0303 Homepage: <http://www.olympus.com.cn>

Customer Service Center:

A8F, Ping An International Financial Center, No. 1-3,

Xinyuan South Road, Chaoyang District, Beijing

Tel: +86-10-58199199 Fax: +86-10-59761360 Zip: 100027

A.32F Shanghai Industrial Investment Building 18

Cao Xi Road(N), Xuhui District, Shanghai

Tel: +86-21-60823500 Fax: +86-21-60823100 Zip: 200030

Rm.1605-1608, Guangzhou International Electronic tower, No403,

Huan Shi East Road, Guang Zhou

Tel: +86-20-61227111 Fax: +86-20-61227120 Zip: 510095

16F Huamin Hanzun Internation Plaza, No.1, Fuxing Street,

Chengdu

Tel: +86-28-86703531 Fax: +86-28-86703532 Zip: 610016

OLYMPUS HONG KONG AND CHINA LIMITED

Digital Camera Repair Centre

L4207, Office Tower, Langham Place, 8 Argyle Street, Mongkok, Kowloon, Hong Kong

Customer Hotline: +852-2376-2150 Fax: +852-2375-0630

<http://www.olympus.com.hk>