

# FUJIFILM

BL01651-201 **EN**

## DIGITAL CAMERA FINEPIX JZ200/JZ100 Series

### Owner's Manual

Thank you for your purchase of this product. This manual describes how to use your FUJIFILM digital camera and the supplied software. Be sure that you have read and understood its contents and the warnings in "For Your Safety" (📖 ii) before using the camera.

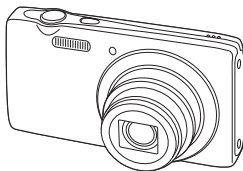

For information on related products, visit our website at [http://www.fujifilm.com/products/digital\\_cameras/index.html](http://www.fujifilm.com/products/digital_cameras/index.html)

Before You Begin

First Steps

Basic Photography and Playback

More on Photography

More on Playback

Movies

Connections

Menus

Technical Notes

Troubleshooting

Appendix

Exif Print

SD<sup>TM</sup>  
XC

PictBridge



# IMPORTANT SAFETY INSTRUCTIONS

- **Read Instructions:** All the safety and operating instructions should be read before the appliance is operated.
- **Retain Instructions:** The safety and operating instructions should be retained for future reference.
- **Heed Warnings:** All warnings on the appliance and in the operating instructions should be adhered to.
- **Follow Instructions:** All operating and use instructions should be followed.

### Installation

**Power Sources:** This video product should be operated only from the type of power source indicated on the marking label. If you are not sure of the type of power supply to your home, consult your appliance dealer or local power company. For video products intended to operate from battery power, or other sources, refer to the operating instructions.

**Grounding or Polarization:** This video product is equipped with a polarized alternating-current line plug (a plug having one blade wider than the other). This plug will fit into the power outlet only one way. This is a safety feature. If you are unable to insert the plug fully into the outlet, try reversing the plug. If the plug should still fail to fit, contact your electrician to replace your obsolete outlet. Do not defeat the safety purpose of the polarized plug.

**Alternate Warnings:** This video product is equipped with a three-wire grounding-type plug, a plug having a third (grounding) pin. This plug will only fit into a grounding-type power outlet. This is a safety feature. If you are unable to insert the plug into the outlet, contact your electrician to replace your obsolete outlet. Do not defeat the safety purpose of the grounding type plug.

**Overloading:** Do not overload wall outlets and extension cords as this can result in a risk of fire or electric shock.

**Ventilation:** Slots and openings in the cabinet are provided for ventilation, to ensure reliable operation of the video product and to protect it from overheating, and these openings must not be blocked or covered. The openings should never be blocked by placing the video product on a bed, sofa, rug, or other similar surface.

This video product should not be placed in a built-in installation such as a bookcase or rack unless proper ventilation is provided or the manufacturer's instructions have been adhered to. This video product should never be placed near or over a radiator or heat register.

**Attachments:** Do not use attachments not recommended by the video product manufacturer as they may cause hazards.

**Water and Moisture:** Do not use this video product near water—for example, near a bath tub, wash bowl, kitchen sink, or laundry tub, in a wet basement, or near a swimming pool, and the like.

**Power-Cord Protection:** Power-supply cords should be routed so that they are not likely to be walked on or pinched by items placed upon or against them, paying particular attention to cords at plugs, convenience receptacles, and the point where they exit from the appliance.

**Accessories:** Do not place this video product on an unstable cart, stand, tripod, bracket, or table. The video product may fall, causing serious injury to a child or adult, and serious damage to the appliance. Use only with a cart, stand, tripod, bracket, or table recommended by the manufacturer, or sold with the video product. Any mounting of the appliance should follow the manufacturer's instructions, and should use a mounting accessory recommended by the manufacturer.

An appliance and cart combination should be moved with care. Quick stops, excessive force, and uneven surfaces may cause the appliance and cart combination to overturn.



**Antennas**

**Outdoor Antenna Grounding:** If an outside antenna or cable system is connected to the video product, be sure the antenna or cable system is grounded so as to provide some protection against voltage surges and built-up static charges. Section 810 of the National Electrical Code, ANSI/NFPA No. 70, provides information with respect to proper grounding of the mast and supporting structure, grounding of the lead-in wire to an antenna discharge unit, size of grounding conductors, location of antenna discharge unit, connection to grounding electrodes, and requirements for the grounding electrode.

*EXAMPLE OF ANTENNA GROUNDING AS PER NATIONAL ELECTRICAL CODE*

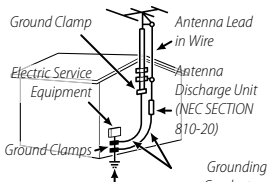

*Power Service Grounding Electrode System (NEC ART 250, PART H)*

*Grounding Conductors (NEC SECTION 810-21)*

**Power Lines:** An outside antenna system should not be located in the vicinity of overhead power lines or other electric light or power circuits, or where it can fall into such power lines or circuits. When installing an outside antenna system, extreme care should be taken to keep from touching such power lines or circuits as contact with them might be fatal.

**Use**

**Cleaning:** Unplug this video product from the wall outlet before cleaning. Do not use liquid cleaners or aerosol cleaners. Use a damp cloth for cleaning.

**Object and Liquid Entry:** Never push objects of any kind into this video product through openings as they may touch dangerous voltage points or short out parts that could result in a fire or electric shock. Never spill liquid of any kind on the video product.

**Lightning:** For added protection for this video product receiver during a lightning storm, or when it is left unattended and unused for long periods of time, unplug it from the wall outlet and disconnect the antenna or cable system. This will prevent damage to the video product due to lightning and power-line surges.

**Service**

**Servicing:** Do not attempt to service this video product yourself as opening or removing covers may expose you to dangerous voltage or other hazards. Refer all servicing to qualified service personnel.

**Damage Requiring Service:** Unplug this video product from the wall outlet and refer servicing to qualified service personnel under the following conditions:

- When the power-supply cord or plug is damaged.
- If liquid has been spilled, or objects have fallen into the video product.
- If the video product has been exposed to rain or water.
- If the video product has been dropped or the cabinet has been damaged.

If the video product does not operate nor-

mally follow the operating instructions. Ad-just only those controls that are covered by the operating instructions as an improper adjustment of other controls may result in damage and will often require extensive work by a qualified technician to restore the video product to its normal operation.

When the video product exhibits a distinct change in performance—this indicates a need for service.

**Replacement Parts:** When replacement parts are required, be sure the service technician has used replacement parts specified by the manufacturer or have the same characteristics as the original part. Unauthorized substitutions may result in fire, electric shock or other hazards.

**Safety Check:** Upon completion of any service or repairs to this video product, ask the service technician to perform safety checks to determine that the video product is in proper operating condition.

**Be sure to read these notes before use**

**Safety Notes**

- Make sure that you use your camera correctly. Read these safety notes and your *Owner's Manual* carefully before use.
- After reading these safety notes, store them in a safe place.

**About the Icons**

The icons shown below are used in this document to indicate the severity of the injury or damage that can result if the information indicated by the icon is ignored and the product is used incorrectly as a result.



**WARNING**

This icon indicates that death or serious injury can result if the information is ignored.



**CAUTION**

This icon indicates that personal injury or material damage can result if the information is ignored.

The icons shown below are used to indicate the nature of the instructions which are to be observed.



**WARNING**

Triangular icons tell you that this information requires attention ("Important").



**WARNING**

Circular icons with a diagonal bar tell you that the action indicated is prohibited ("Prohibited").



**WARNING**

Filled circles with an exclamation mark indicate an action that must be performed ("Required").

**WARNING**



**Unplug from power source**

**If a problem arises, turn the camera off, remove the battery, and disconnect and unplug the AC power adapter.** Continued use of the camera when it is emitting smoke, is emitting any unusual odor, or is in any other abnormal state can cause a fire or electric shock. Contact your FUJIFILM dealer.



**Avoid exposure to water**

**Do not allow water or foreign objects to enter the camera.** If water or foreign objects get inside the camera, turn the camera off, remove the battery, and disconnect and unplug the AC power adapter. Continued use of the camera can cause a fire or electric shock. Contact your FUJIFILM dealer.

**WARNING**



**Do not use in the bathroom or shower**

**Do not use the camera in the bathroom or shower.** This can cause a fire or electric shock.



**Do not disassemble**

**Never attempt to change or take apart the camera (never open the case).** Failure to observe this precaution can cause fire or electric shock.



**Do not touch internal parts**

**Should the case break open as the result of a fall or other accident, do not touch the exposed parts.** Failure to observe this precaution could result in electric shock or injury from touching the damaged parts. Remove the battery immediately, taking care to avoid injury or electric shock, and take the product to the point of purchase for consultation.



**Do not change, heat or unduly twist or pull the connection cord and do not place heavy objects on the connection cord.** These actions could damage the cord and cause a fire or electric shock. If the cord is damaged, contact your FUJIFILM dealer.

**Do not change, heat or unduly twist or pull the connection cord and do not place heavy objects on the connection cord.** These actions could damage the cord and cause a fire or electric shock. If the cord is damaged, contact your FUJIFILM dealer.



**Do not place the camera on an unstable surface.** This can cause the camera to fall or tip over and cause injury.

**Do not place the camera on an unstable surface.** This can cause the camera to fall or tip over and cause injury.



**Never attempt to take pictures while in motion.** Do not use the camera while you are walking or driving a vehicle. This can result in you falling down or being involved in a traffic accident.

**Never attempt to take pictures while in motion.** Do not use the camera while you are walking or driving a vehicle. This can result in you falling down or being involved in a traffic accident.



**Do not touch any metal parts of the camera during a thunderstorm.** This can cause an electric shock due to induced current from the lightning discharge.

**Do not touch any metal parts of the camera during a thunderstorm.** This can cause an electric shock due to induced current from the lightning discharge.



**Do not use the battery except as specified.** Load the battery as shown by the indicator.

**Do not use the battery except as specified.** Load the battery as shown by the indicator.



**Do not heat, change or take apart the battery. Do not drop or subject the battery to impacts. Do not store the battery with metallic products.** Any of these actions can cause the battery to burst or leak and cause fire or injury as a result.

**Do not heat, change or take apart the battery. Do not drop or subject the battery to impacts. Do not store the battery with metallic products.** Any of these actions can cause the battery to burst or leak and cause fire or injury as a result.









**Use only the battery or AC power adapters specified for use with this camera. Do not use voltages other than the power supply voltage shown.** The use of other power sources can cause a fire.







**Use only the battery or AC power adapters specified for use with this camera. Do not use voltages other than the power supply voltage shown.** The use of other power sources can cause a fire.











**If the battery leaks and fluid gets in contact with your eyes, skin or clothing, flush the affected area with clean water and seek medical attention or call an emergency number right away.**

**If the battery leaks and fluid gets in contact with your eyes, skin or clothing, flush the affected area with clean water and seek medical attention or call an emergency number right away.**

 <b>WARNING</b>	
	<b>Do not use the charger to charge batteries other than those specified here.</b> The supplied battery charger is for use only with the type of battery supplied with the camera. Using the charger to charge conventional batteries or other types of rechargeable batteries can cause the battery to leak fluid, overheat or burst.
	<b>Danger of explosion if battery is incorrectly replaced. Replace only with the same or equivalent type.</b>
	<b>Do not use in the presence of flammable objects, explosive gases, or dust.</b>
	<b>When carrying the battery, install it in a digital camera or keep it in the hard case. When storing the battery, keep it in the hard case. When discarding, cover the battery terminals with insulation tape.</b> Contact with other metallic objects or batteries could cause the battery to ignite or burst.
	<b>Keep memory cards out of the reach of small children.</b> Because memory cards are small, they can be swallowed by children. Be sure to store memory cards out of the reach of small children. If a child swallows a memory card, seek medical attention or call an emergency number.

 <b>CAUTION</b>	
	<b>Do not use this camera in locations affected by oil fumes, steam, humidity or dust.</b> This can cause a fire or electric shock.
	<b>Do not leave this camera in places subject to extremely high temperatures.</b> Do not leave the camera in locations such as a sealed vehicle or in direct sunlight. This can cause a fire.
	<b>Keep out of the reach of small children.</b> This product could cause injury in the hands of a child.
	<b>Do not place heavy objects on the camera.</b> This can cause the heavy object to tip over or fall and cause injury.
	<b>Do not move the camera while the AC power adapter is still connected. Do not pull on the connection cord to disconnect the AC power adapter.</b> This can damage the power cord or cables and cause a fire or electric shock.
	<b>Do not use the AC power adapter when the plug is damaged or the plug socket connection is loose.</b> This could cause a fire or electric shock.

 <b>CAUTION</b>	
	<b>Do not cover or wrap the camera or the AC power adapter in a cloth or blanket.</b> This can cause heat to build up and distort the casing or cause a fire.
	<b>When you are cleaning the camera or you do not plan to use the camera for an extended period, remove the battery and disconnect and unplug the AC power adapter.</b> Failure to do so can cause a fire or electric shock.
 <small>Unplug from power socket</small>	<b>When charging ends, unplug the charger from the power socket.</b> Leaving the charger plugged into the power socket can cause a fire.
	<b>Using a flash too close to a person's eyes may temporarily affect the eyesight.</b> Take particular care when photographing infants and young children.
	<b>When a memory card is removed, the card could come out of the slot too quickly. Use your finger to hold it and gently release the card. Injury could result to those struck by the ejected card.</b>
	<b>Request regular internal testing and cleaning for your camera.</b> Build-up of dust in your camera can cause a fire or electric shock. Contact your FUJIFILM dealer to request internal cleaning every two years. Please note that this service is not free of charge.
	<b>Remove your fingers from the flash window before the flash fires.</b> Failure to observe this precaution could result in burns.
	<b>Keep the flash window clean and do not use the flash if the window is obstructed.</b> Failure to observe these precautions could cause smoke or discoloration.

### The Battery and Power Supply

**Note:** Check the type of battery used in your camera and read the appropriate sections.

The following describes the proper use of batteries and how to prolong their life. Incorrect use can shorten battery life or cause leakage, overheating, fire, or explosion.

#### Li-ion Batteries

*Read this section if your camera uses a rechargeable Li-ion battery.*

The battery is not charged at shipment. Charge the battery before use. Keep the battery in its case when not in use.

#### Notes on the Battery

The battery gradually loses its charge when not in use. Charge the battery one or two days before use.

Battery life can be extended by turning the camera off when not in use.

Battery capacity decreases at low temperatures; a depleted battery may not function at when cold. Keep a fully charged spare battery in a warm place and exchange as necessary, or keep the battery in your pocket or other warm place and insert it in the camera only when shooting. Do not place the battery in direct contact with hand warmers or other heating devices.

#### Charging the Battery

Charge the battery in the supplied battery charger. Charging times will increase at ambient temperatures below +10°C (+50°F) or above +35°C (+95°F). Do not attempt to charge the battery at temperatures above 40°C (+104°F); at temperatures below 0°C (+32°F), the battery will not charge.

Do not attempt to recharge a fully charged battery. The battery does not however need to be fully discharged before charging.

The battery may be warm to the touch immediately after charging or use. This is normal.

#### Battery Life

At normal temperatures, the battery can be recharged about 300 times. A noticeable decrease in the length of time the battery will hold a charge indicates that it has reached the end of its service life and should be replaced.

#### Storage

Performance may be impaired if the battery is left unused for extended periods when fully charged. Run the battery flat before storing it.

If the camera will not be used for an extended period, remove the battery and store it in a dry place with an ambient temperature of from +15°C to +25°C (+59°F to +77°F). Do not store in locations exposed to extremes of temperature.

#### Cautions: Handling the Battery

- Do not transport or store with metal objects such as necklaces or hairpins.
- Do not expose to flame or heat.
- Do not disassemble or modify.
- Use with designated chargers only.
- Do not drop or subject to strong physical shocks.
- Do not expose to water.
- Keep the terminals clean.
- The battery and camera body may become warm to the touch after extended use. This is normal.

#### AA Alkaline/Rechargeable Ni-MH Batteries

*Read this section if your camera uses AA alkaline or rechargeable AA Ni-MH batteries.* Information on compatible battery types may be found elsewhere in the camera manual.

#### Cautions: Handling the Batteries

- Do not expose to water, flame, or heat, or store in warm or humid conditions.
- Do not transport or store with metal objects such as necklaces or hairpins.
- Do not disassemble or modify the batteries or battery casing.
- Do not subject to strong physical shocks.
- Do not use batteries that are leaking, deformed, or discolored.
- Keep out of reach of infants and small children.
- Insert in the correct orientation.

- Do not mix old and new batteries, batteries with different charge levels, or batteries of different types.
- If the camera will not be used for an extended period, remove the batteries. Note that the camera clock will be reset.
- The batteries may be warm to the touch immediately after use. Turn the camera off and allow the batteries to cool before handling.
- Battery capacity tends to decrease at low temperatures. Keep spare batteries in a pocket or other warm place and exchange as necessary. Cold batteries may recover some of their charge when warmed.
- Fingerprints and other stains on the battery terminals can impair battery performance. Thoroughly clean the terminals with a soft, dry cloth before inserting them in the camera.



If the batteries leak, clean the battery compartment thoroughly before inserting new batteries.



If fluid from the battery comes into contact with skin or clothing, flush the affected area with water. **If fluid enters your eyes, immediately flush the affected area with water and seek medical attention. Do not rub your eyes. Failure to observe this precaution could result in permanent visual impairment.**

#### ■ Ni-MH Batteries

The capacity of Ni-MH batteries may be temporarily reduced when new, after long periods of disuse, or if they are repeatedly recharged before being fully discharged. This is normal and does not indicate a malfunction. Capacity can be increased by repeatedly discharging the batteries using the discharge option in the camera setup menu and recharging them using a battery charger (sold separately).

ⓘ **CAUTION:** Do not use the discharge option with alkaline batteries.

The camera draws a small amount of current even when off. Ni-MH batteries that have been left in the camera for an extended period may be drawn down to the point that they no longer hold a charge. Battery performance may also drop if the batteries are run down in a device such as a flashlight. Use the discharge option in the camera setup menu to discharge Ni-MH batteries. Batteries that no longer hold a charge even after repeatedly being discharged and recharged have reached the end of their service life and must be replaced.

Ni-MH batteries can be recharged in a battery charger (sold separately). Batteries may become warm to the touch after charging. Refer to the instructions provided with the charger for more information. Use the charger with compatible batteries only.

Ni-MH batteries gradually lose their charge when not in use.

#### ■ Disposal

Dispose of used batteries in accord with local regulations.

#### **AC Power Adapters (Available Separately)**

*This section applies to all camera models.*

Use only FUJIFILM AC power adapters designated for use with this camera. Other adapters could damage the camera.

- The AC power adapter is for indoor use only.
- Be sure the DC plug is securely connected to the camera.
- Turn the camera off before disconnecting the adapter. Disconnect the adapter by the plug, not the cable.
- Do not use with other devices.
- Do not disassemble.
- Do not expose to high heat and humidity.
- Do not subject to strong physical shocks.
- The adapter may hum or become hot to the touch during use. This is normal.
- If the adapter causes radio interference, reorient or relocate the receiving antenna.

### Using the Camera

Do not aim the camera at extremely bright light sources, such as the sun in a cloudless sky. Failure to observe this precaution could damage the camera image sensor.

### Take Test Shots

Before taking photographs on important occasions (such as at weddings or before taking the camera on a trip), take a test shot and view the result in the LCD monitor to ensure that the camera is functioning normally. FUJIFILM Corporation can not accept liability for damages or lost profits incurred as a result of product malfunction.

### Notes on Copyright

Unless intended solely for personal use, images recorded using your digital camera system may be used in ways that infringe copyright laws without the consent of the owner. Note that some restrictions apply to the photographing of stage performances, entertainments, and exhibits, even when intended purely for personal use. Users are also asked to note that the transfer of memory cards containing images or data protected under copyright laws is only permissible within the restrictions imposed by those copyright laws.

### Handling

To ensure that images are recorded correctly, do not subject the camera to impact or physical shocks while images are being recorded.

### Liquid Crystal

In the event that the LCD monitor is damaged, care should be taken to avoid contact with liquid crystal. Take the urgent action indicated should any of the following situations arise:

- **If liquid crystal comes in contact with your skin**, clean the area with a cloth and then wash thoroughly with soap and running water.
- **If liquid crystal enters your eyes**, flush the affected eye with clean water for at least 15 minutes and then seek medical assistance.
- **If liquid crystal is swallowed**, rinse your mouth thoroughly with water. Drink large quantities of water and induce vomiting, then seek medical assistance.

Although the display is manufactured using extremely high-precision technology, it may contain pixels that are always lit or that do not light. This is not a malfunction, and images recorded with the product are unaffected.

### Trademark Information

**xD-Picture Card** and **xD** are trademarks of FUJIFILM Corporation. The typefaces included herein are solely developed by DynaComware Taiwan Inc. Macintosh, QuickTime, and Mac OS are trademarks of Apple Inc. in the U.S.A. and other countries. Windows 7, Windows Vista, and the Windows logo are trademarks of the Microsoft group of companies. Adobe and Adobe Reader are either trademarks or registered trademarks of Adobe Systems Incorporated in the U.S.A. and/or other countries. The SDHC and SDXC logos are trademarks of SD-3C, LLC. The HDMI logo is a trademark. YouTube is a trademark of Google Inc. All other trade names mentioned in this manual are the trademarks or registered trademarks of their respective owners.

### Electrical Interference

This camera may interfere with hospital or aviation equipment. Consult with hospital or airline staff before using the camera in a hospital or on an aircraft.

### Color Television Systems

NTSC (National Television System Committee) is a color television telecasting specification adopted mainly in the U.S.A., Canada, and Japan. PAL (Phases Alternation by Line) is a color television system adopted mainly in European countries and China.

### Exif Print (Exif Version 2.3)

Exif Print is a newly revised digital camera file format in which information stored with photographs is used for optimal color reproduction during printing.

### IMPORTANT NOTICE: Read Before Using the Software

Direct or indirect export, in whole or in part, of licensed software without the permission of the applicable governing bodies is prohibited.



## About This Manual

Before using the camera, read this manual and the warnings in “For Your Safety” (📖 ii). For information on specific topics, consult the sources below.

### **Table of Contents** ..... 📖 xi

The “Table of Contents” gives an overview of the entire manual. The principal camera operations are listed here.

### **Troubleshooting** ..... 📖 76

Having a specific problem with the camera? Find the answer here.

### **Warning Messages and Displays** ..... 📖 81

Find out what’s behind that flashing icon or error message in the display.

### **Memory Cards**

Pictures can be stored in an optional SD, SDHC, and SDXC memory cards (📖 11), referred to in this manual as “memory cards”.

## Frequently-Used Buttons

### ■ Turning the Camera on in Playback Mode

- ➔ When the camera is off, playback can be started by pressing the  button for about a second.



### ■ Taking Pictures During Playback

- ➔ To return instantly to shooting mode, press the shutter button halfway.



### ■ Silent Mode

- ➔ Press and hold the **DISP/BACK** button to disable camera lights and sounds.



### ■ Deleting Pictures





- ➔ Press the selector up () to display deletion options.





# Table of Contents

<b>For Your Safety</b> .....	ii
IMPORTANT SAFETY INSTRUCTIONS .....	ii
Safety Notes .....	iv
<b>About This Manual</b> .....	ix
<b>Frequently-Used Buttons</b> .....	x
<b>Before You Begin</b>	
<b>Symbols and Conventions</b> .....	1
<b>Supplied Accessories</b> .....	1
<b>Parts of the Camera</b> .....	2
Camera Displays .....	4
Shooting .....	4
Playback.....	5
<b>First Steps</b>	
<b>Charging the Battery</b> .....	6
<b>Inserting the Battery and a Memory Card</b> .....	8
Compatible Memory Cards .....	11
<b>Turning the Camera on and Off</b> .....	13
Shooting Mode .....	13
Playback Mode.....	13
<b>Basic Setup</b> .....	15
<b>Basic Photography and Playback</b>	
<b>Taking Pictures in  (Scene Recognition) Mode</b> .....	16
<b>Viewing Pictures</b> .....	19











## More on Photography





































<b>Shooting Mode</b> .....	20
Choosing a Shooting Mode .....	20
Shooting Mode Options .....	21
<b>Focus Lock</b> .....	22
 <b>Exposure Compensation</b> .....	24
 <b>Macro Mode (Close-ups)</b> .....	25
 <b>Using the Flash (Intelligent Flash)</b> .....	26
 <b>Using the Self-Timer</b> .....	28
 <b>Intelligent Face Detection</b> .....	29

## More on Playback

<b>Playback Options</b> .....	30
★ Favorites: Rating Pictures .....	30
Playback Zoom .....	31
Multi-Frame Playback .....	32
 <b>Deleting Pictures</b> .....	33
 <b>Image Search</b> .....	34
 <b>PhotoBook Assist</b> .....	35
Creating a PhotoBook.....	35
Viewing PhotoBooks .....	36
Editing and Deleting Photobooks.....	36

<b>Movies</b>	
Recording Movies.....	37
Viewing Movies.....	39
<b>Connections</b>	
Viewing Pictures on TV.....	40
Printing Pictures via USB.....	41
Printing the DPOF Print Order.....	43
Viewing Pictures on a Computer.....	45
Windows: Installing MyFinePix Studio.....	45
Macintosh: Installing FinePixViewer.....	47
Connecting the Camera.....	49

<b>Menus</b>	
Using the Menus: Shooting Mode.....	52
Using the Shooting Menu.....	52
Shooting Menu Options.....	52
 SHOOTING MODE.....	52
 ISO.....	52
 IMAGE SIZE.....	53
 IMAGE QUALITY.....	54
 FINEPIX COLOR.....	54
 WB WHITE BALANCE.....	55
 CONTINUOUS.....	55
 FACE DETECTION.....	56
 AF MODE.....	56
 MOVIE MODE.....	57

<b>Using the Menus: Playback Mode</b> .....	58	<b>The Setup Menu</b> .....	64
Using the Playback Menu .....	58	Using the Setup Menu .....	64
Playback Menu Options .....	58	Setup Menu Options .....	65
 PHOTOBOK ASSIST .....	58	 DATE/TIME .....	65
 IMAGE SEARCH .....	58	 TIME DIFFERENCE .....	65
 ERASE .....	58	 言語/LANG .....	65
 MOVIE EDIT .....	59	 SILENT MODE .....	65
 MARK FOR UPLOAD TO .....	60	 RESET .....	66
 SLIDE SHOW .....	61	 FORMAT .....	66
 RED EYE REMOVAL .....	61	 IMAGE DISP. ....	66
 PROTECT .....	62	 FRAME NO. ....	67
 CROP .....	62	 OPERATION VOL. ....	67
 RESIZE .....	63	 SHUTTER VOLUME .....	67
 IMAGE ROTATE .....	63	 SHUTTER SOUND .....	68
 PRINT ORDER (DPOF) .....	63	 PLAYBACK VOLUME .....	68
		 LCD BRIGHTNESS .....	68
		 LCD MODE .....	68
		 AUTO POWER OFF .....	68
		 DUAL IS MODE .....	69
		 RED EYE REMOVAL .....	69
		 DIGITAL ZOOM .....	70
		 MOVIE ZOOM TYPE .....	70
		 SAVE ORG. IMAGE .....	70
		 BACKGROUND COLOR .....	71
		 GUIDANCE DISPLAY .....	71
		 VIDEO SYSTEM .....	71
		 DATE STAMP .....	71

<b>Technical Notes</b>	
<b>Optional Accessories</b> .....	72
Printing .....	72
Computer Related.....	72
Audio/Visual .....	72
Accessories from FUJIFILM.....	73
<b>Caring for the Camera</b> .....	74
Storage and Use .....	74
Water and Sand.....	74
Condensation.....	74
Cleaning.....	75
Traveling .....	75

<b>Troubleshooting</b>	
<b>Problems and Solutions</b> .....	76
<b>Warning Messages and Displays</b> .....	81

<b>Appendix</b>	
<b>Tips and Tricks</b> .....	85
<b>Memory Card Capacity</b> .....	88
FinePix JZ200 series .....	88
FinePix JZ100 series .....	89
<b>Specifications</b> .....	90

# Before You Begin

## Symbols and Conventions

The following symbols are used in this manual:

- ⓘ : This information should be read before use to ensure correct operation.
- 📖 : Additional information that may be helpful when using the camera.
- 📖 : Other pages in this manual on which related information may be found.

Menus and other text in the LCD monitor are shown in **bold**. In the illustrations in this manual, displays may be simplified for explanatory purposes.

## Supplied Accessories

The following items are included with the camera:

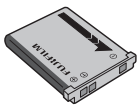

NP-45A or NP-45B  
rechargeable battery

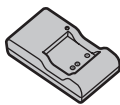

BC-45B battery charger



USB cable

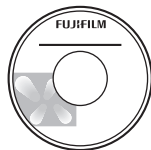

CD-ROM (contains  
this manual)

- Strap
- *User Guide/  
Basic Manual*

### Attaching the Strap

Attach the strap as shown.

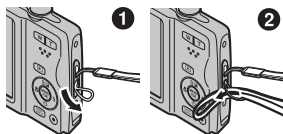

## Parts of the Camera

For more information, refer to the page listed to the right of each item.

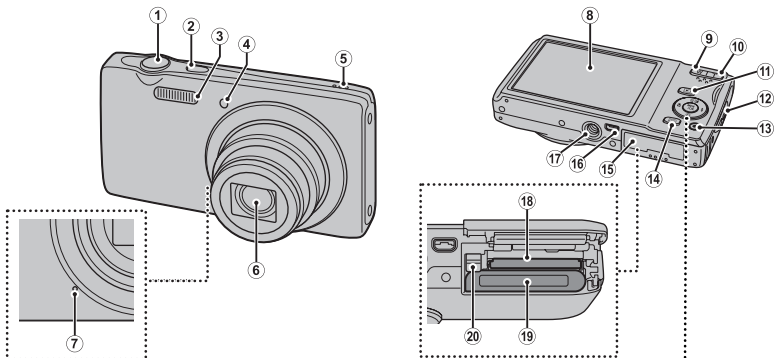

### Selector button

#### Move cursor up

- (exposure compensation) button ( 24)
- (delete) button ( 24)

MENU/OK button

#### Move cursor left

- (macro) button ( 25)

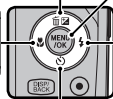

#### Move cursor right



- (flash) button ( 26)

#### Move cursor down

- (self-timer) button ( 28)

\* Illustrations in this manual may be simplified for explanatory purposes.



<b>1</b>	Shutter button .....	18	<b>12</b>	Strap eyelet .....	1
<b>2</b>	<b>ON/OFF</b> button .....	13	<b>13</b>	 (movie recording) button .....	37
<b>3</b>	Flash .....	26	<b>14</b>	<b>DISP</b> (display)/ <b>BACK</b> button .....	5, 15
<b>4</b>	Self-timer lamp .....	28	 (silent mode) button* .....	X	
<b>5</b>	Speaker .....	39	<b>15</b>	Battery-chamber cover .....	8
<b>6</b>	Lens and lens cover		<b>16</b>	USB multi-connector .....	40, 41, 49
<b>7</b>	Microphone .....	37	<b>17</b>	Tripod mount	
<b>8</b>	LCD monitor .....	4	<b>18</b>	Memory card slot .....	9
<b>9</b>	<b>W</b> (zoom out) button .....	17, 31	<b>19</b>	Battery chamber .....	8
<b>10</b>	<b>T</b> (zoom in) button .....	17, 31	<b>20</b>	Battery latch .....	8, 10
<b>11</b>	 (playback) button .....	19			

\*Press and hold the **DISP/BACK** button until  is displayed.

**Camera Displays**

The following types of indicator may be displayed during shooting and playback. Indicators vary with camera settings.

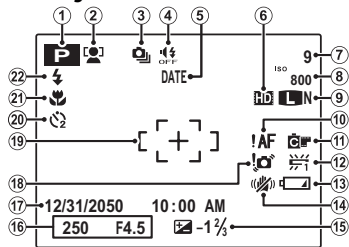
**Shooting**

7	Number of available frames.....	88
8	Sensitivity.....	52
9	Image size/Image quality.....	53, 54
10	Focus warning.....	18, 81
11	FINEPIX color.....	54
12	White balance.....	55
13	Battery level.....	5
14	Dual IS mode.....	69
15	Exposure compensation.....	24
16	Shutter speed/Aperture.....	
17	Date and time.....	15
18	Blur warning.....	27, 81
19	Focus frame.....	22
20	Self-timer indicator.....	28
21	Macro (close-up) mode.....	25
22	Flash mode.....	26

## ■ Playback

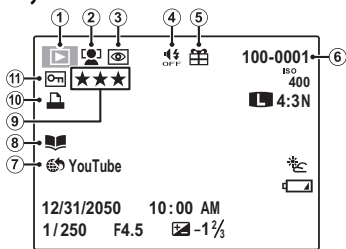

<b>1</b>	Playback mode indicator.....	19, 30
<b>2</b>	Intelligent Face Detection indicator .....	29, 56
<b>3</b>	Red-eye removal indicator .....	61
<b>4</b>	Silent mode indicator .....	3, 65
<b>5</b>	Gift image.....	30
<b>6</b>	Frame number.....	67
<b>7</b>	Mark for upload to .....	60
<b>8</b>	Photobook assist.....	35
<b>9</b>	Favorites .....	30
<b>10</b>	DPOF print indicator .....	43
<b>11</b>	Protected image .....	62

### ● Battery Level

Battery level is shown as follows:

Indicator	Description
(white)	Battery partially discharged.
(white)	Battery more than half discharged.
(red)	Low battery. Charge as soon as possible.
(blinks red)	Battery exhausted. Turn camera off and charge battery.

### ● Hiding and Viewing Indicators

Press **DISP/BACK** to cycle through shooting and playback indicators as follows:

- **Shooting:** Indicators displayed/indicators hidden/best framing
- **Playback:** Indicators displayed/indicators hidden/★ favorites

# First Steps

## Charging the Battery

The battery is not charged at shipment. Charge the battery before use.

### 1 Place the battery in the supplied battery charger.

Insert the battery in the orientation indicated by the ⊕ ⊕ ⊖ labels.

The camera uses an NP-45A/NP-45B rechargeable battery.

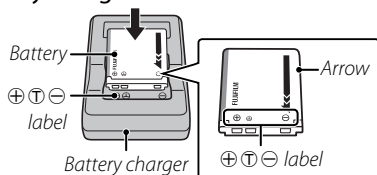

### 2 Plug the charger in.

Plug the charger into a power outlet. The charging indicator will light.

#### The Charging Indicator

The charging indicator shows battery charge status as follows:

Charging indicator	Battery status	Action
Off	Battery not inserted.	Insert the battery.
On (green)	Battery fully charged.	Remove the battery.
On (yellow)	Battery charging.	—
Blinks (yellow)	Battery fault.	Unplug the charger and remove the battery.

### 3 Charge the battery.

Remove the battery when charging is complete. See the specifications (📖94) for charging times (note that charging times increase at low temperatures).

- ⓘ Unplug the charger when it is not in use.

## Inserting the Battery and a Memory Card

Insert the battery and memory card as described below.

### 1 Open the battery-chamber cover.

◆ Be sure the camera is off before opening the battery-chamber cover.

ⓘ Do not open the battery-chamber cover when the camera is on. Failure to observe this precaution could result in damage to image files or memory cards.

ⓘ Do not use excessive force when handling the battery-chamber cover.

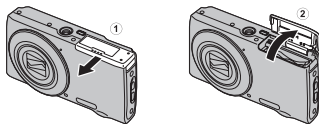

### 2 Insert the battery.

Align the orange stripe on the battery with the orange battery latch and slide the battery into the camera, keeping the battery latch pressed to one side. When inserting the battery, be sure that the battery is secured by the orange battery latch. If the battery is not securely latched, the camera may not turn on or may turn off without warning.

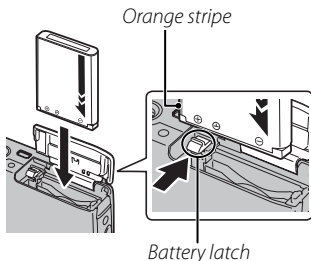

ⓘ Insert the battery in the correct orientation. **Do not use force or attempt to insert the battery upside down or backwards.** The battery will slide in easily in the correct orientation.

### 3 Insert the memory card.

Holding the memory card in the orientation shown at right, slide it in until it clicks into place at the back of the slot.

- ① Be sure card is in the correct orientation; do not insert at an angle or use force.

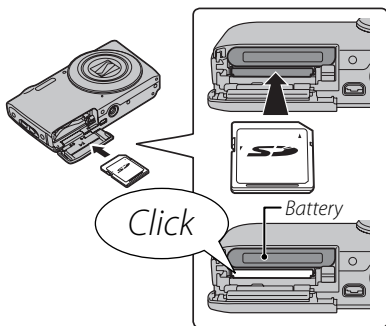

- ① SD/SDHC/SDXC memory cards can be locked, making it impossible to format the card or to record or delete images. Before inserting an SD/SDHC/SDXC memory card, slide the write-protect switch to the unlocked position.

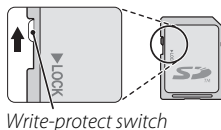

### 4 Close the battery-chamber cover.

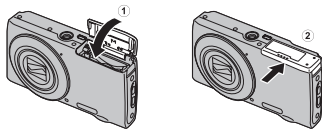

### Removing the Battery and Memory Card

Before removing the battery or memory card, **turn the camera off** and open the battery-chamber cover.

To remove the battery, press the battery latch to the side, and slide the battery out of the camera as shown.

Battery latch

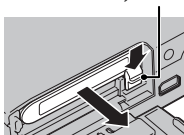

To remove the memory card, press it in and release it slowly. The card can then be removed by hand. When a memory card is removed, the card could come out of the slot too quickly. Use your finger to hold it and gently release the card.

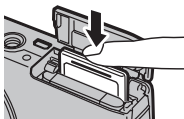



## ■ Compatible Memory Cards

FUJIFILM and SanDisk SD, SDHC, and SDXC memory cards have been approved for use in the camera. A complete list of approved memory cards is available at [http://www.fujifilm.com/support/digital\\_cameras/compatibility/](http://www.fujifilm.com/support/digital_cameras/compatibility/). Operation is not guaranteed with other cards. The camera can not be used with *xD-Picture Cards* or MultiMediaCard (MMC) devices.

### ① Memory Cards

- **Do not turn the camera off or remove the memory card while the memory card is being formatted or data are being recorded to or deleted from the card.** Failure to observe this precaution could damage the card.
- Format SD/SDHC/SDXC memory cards before first use, and be sure to reformat all memory cards after using them in a computer or other device. For more information on formatting memory cards, see “ **FORMAT**” (📖 66).
- Memory cards are small and can be swallowed; keep out of reach of children. If a child swallows a memory card, seek medical assistance immediately.
- miniSD or microSD adapters that are larger or smaller than the standard dimensions of an SD/SDHC/SDXC memory card may not eject normally; if the card does not eject, take the camera to an authorized service representative. Do not forcibly remove the card.
- Do not affix labels to memory cards. Peeling labels can cause camera malfunction.
- Movie recording may be interrupted with some types of SD/SDHC/SDXC memory card. Use a **CLASS 4** card or better when shooting HD.
- Formatting a memory card in the camera creates a folder in which pictures are stored. Do not rename or delete this folder or use a computer or other device to edit, delete, or rename image files. Always use the camera to delete pictures; before editing or renaming files, copy them to a computer and edit or rename the copies, not the originals.

### ⓘ **Batteries**

- Remove dirt from the battery terminals with a clean, dry cloth. Failure to observe this precaution could prevent the battery from charging.
- Do not affix stickers or other objects to the battery. Failure to observe this precaution could make it impossible to remove the battery from the camera.
- Do not short the battery terminals. The battery could overheat.
- Read the cautions in “The Battery and Power Supply” (📖 vi).
- Use only battery chargers designated for use with the battery. Failure to observe this precaution could result in product malfunction.
- Do not remove the labels from the battery or attempt to split or peel the outer casing.
- The battery gradually loses its charge when not in use. Charge the battery one or two days before use.

## Turning the Camera on and Off

### ***Shooting Mode***

Press the **ON/OFF** button to turn the camera on. The lens will extend and the lens cover will open.

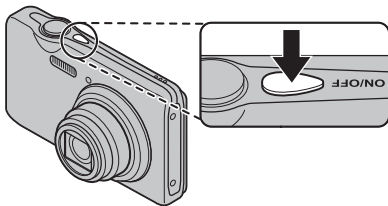

Press **ON/OFF** again to turn the camera off.

### ◆ **Switching to Playback Mode**

Press the  button to start playback. Press the shutter button halfway to return to shooting mode.

### ***Playback Mode***

To turn the camera on and begin playback, press the  button for about a second.

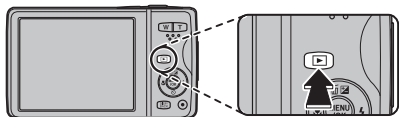

Press the  button again or press the **ON/OFF** button to turn the camera off.

### ◆ **Switching to Shooting Mode**



To exit to shooting mode, press the shutter button halfway. Press the  button to return to playback.

- ⓘ Forcibly obstructing the lens could cause damage or product malfunction.
- ⓘ Fingerprints and other marks on the lens can affect pictures. Keep the lens clean.
- ⓘ The **ON/OFF** button does not completely end the supply of power to the camera.

### 🔍 **Auto Power Off**

The camera will turn off automatically if no operations are performed for the length of time selected for  **AUTO POWER OFF** (📖 68).

## Basic Setup

A language-selection dialog is displayed the first time the camera is turned on. Set up the camera as described below (you can reset the clock or change languages at any time using the  **DATE/TIME** or  **言語/LANG.** options in the setup menu; for information on displaying the setup menu, see page 64).

### 1 Highlight a language and press **MENU/OK**.

- ◆ Press **DISP/BACK** to skip the current step. Any steps you skip will be displayed the next time the camera is turned on.

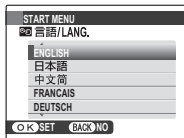

### 2 The date and time will be displayed. Press the selector left or right to highlight the year, month, day, hour, or minute and press up or down to change. To change the order in which the year, month, and day are displayed, highlight the date format and press the selector up or down. Press **MENU/OK** when settings are complete.

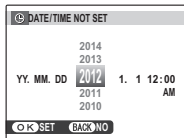

### ◆ The Camera Clock

If the battery is removed for an extended period, the camera clock will be reset and the language-selection dialog will be displayed when the camera is turned on.

# Basic Photography and Playback

## Taking Pictures in **SR AUTO** (Scene Recognition) Mode

This section describes how to take pictures in **SR AUTO** (scene recognition) mode. The camera automatically analyzes the composition and adjusts settings appropriately.

### 1 Turn the camera on.

Press the **ON/OFF** button to turn the camera on. **SR AUTO** shooting indicators will be displayed.

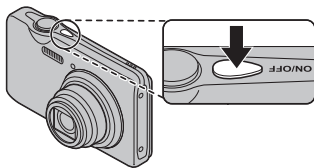







### The Icon

This icon indicates that the camera continuously searches for faces to select the appropriate scene, increasing the drain on the battery.



### Scene Icon

The camera selects the scene according to shooting conditions and the type of subject:  PORTRAIT (portraits),  LANDSCAPE (landscapes),  NIGHT (poorly-lit landscapes),  MACRO (close ups),  NIGHT PORTRAIT (poorly-lit portraits),  BACKLIT PORTRAIT (backlit portraits),  AUTO (all other scenes)

## 2 Frame the picture.

Use the zoom buttons to frame the picture in the display.

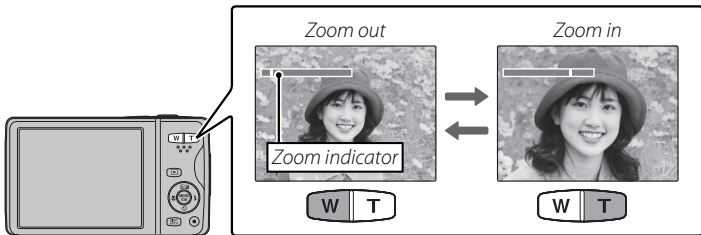

### Holding the Camera

Hold the camera steady with both hands and brace your elbows against your sides. Shaking or unsteady hands can blur your shots.



To prevent pictures that are out of focus or too dark (underexposed), keep your fingers and other objects away from the lens and flash.

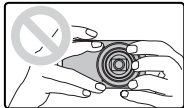

### 3 Focus.

Press the shutter button halfway to focus.

- ◆ The lens may make a noise when the camera focuses; this is normal.

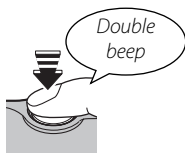



**If the camera is able to focus**, it will beep twice.

**If the camera is unable to focus**, the focus frame will turn red, **!AF** will be displayed. Change the composition or use focus lock ( 22).

### 4 Shoot.

Smoothly press the shutter button the rest of the way down to take the picture.

- ◆ If the subject is poorly lit, the flash may fire when the picture is taken. For information on using the flash when lighting is poor, see “ Using the Flash (Intelligent Flash)” ( 26).



#### **The Shutter Button**

The shutter button has two positions. Pressing the shutter button halfway sets focus and exposure; to shoot, press the shutter button the rest of the way down.



## Viewing Pictures

Pictures can be viewed in the LCD monitor. When taking important photographs, take a test shot and check the results.

### 1 Press the button.

The most recent picture will be displayed.

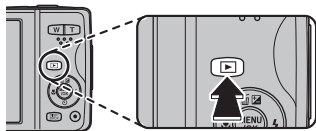

### 2 View additional pictures.

Press the selector right to view pictures in the order recorded, left to view pictures in reverse order.

Press the shutter button to exit to shooting mode.

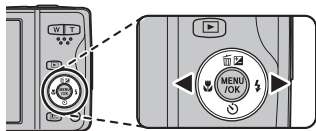

# More on Photography

## Shooting Mode

Choose a shooting mode according to the scene or type of subject.

### Choosing a Shooting Mode

1 Press **MENU/OK** to display the shooting menu.

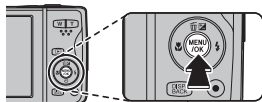

2 Highlight **SHOOTING MODE** and press the selector right to display shooting mode options.

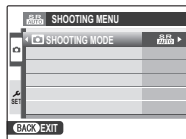



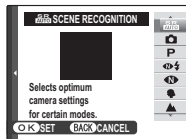













3 Highlight the desired mode and press **MENU/OK**.



4 Press **DISP/BACK** to exit to shooting mode.

***Shooting Mode Options***

Scene	Description
 <b>SCENE RECOGNITION</b>	The camera automatically analyzes the composition and selects a scene according to shooting conditions and the type of subject.
 <b>AUTO</b>	Choose for crisp, clear snapshots. This mode is recommended in most situations.
<b>P PROGRAM AE</b>	Options for white balance and AF mode will be fully available and exposure compensation can be adjusted manually.
 <b>NATURAL &amp; </b>	The camera takes two shots: one without the flash and one with.
 <b>NATURAL LIGHT</b>	Capture natural lighting under low-light conditions.
 <b>PORTRAIT</b>	Choose for portraits.
 <b>LANDSCAPE</b>	Choose for daylight shots of buildings and landscapes.
 <b>SPORT</b>	Choose when photographing moving subjects.
 <b>NIGHT</b>	Choose this mode for poorly lit twilight or night scenes.
 <b>NIGHT (TRIPOD)</b>	Choose this mode for slow shutter speeds when shooting at night.
 <b>FIREWORKS</b>	Slow shutter speeds are used to capture the expanding burst of light from a firework.
 <b>SUNSET</b>	Choose this mode to record the vivid colors in sunrises and sunsets.
 <b>SNOW</b>	Choose for crisp, clear shots that capture the brightness of scenes dominated by shining white snow.
 <b>BEACH</b>	Choose for crisp, clear shots that capture the brightness of sunlit beaches.
 <b>PARTY</b>	Capture indoor background lighting under low-light conditions.
 <b>FLOWER</b>	Choose for vivid close-ups of flowers.
 <b>TEXT</b>	Take clear pictures of text or drawings in print.

## Focus Lock

To compose photographs with off-center subjects:

- 1 Focus:** Position the subject in the focus frame (⌘[+]) and press the shutter button halfway to lock focus and exposure. Focus and exposure will remain locked while the shutter button is pressed halfway (AF/AE lock).
- 2 Recompose:** Keep the button pressed halfway.
- 3 Shoot:** Press the button all the way down.

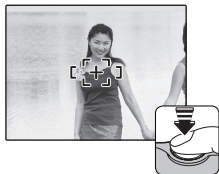



 **Autofocus**

Although the camera boasts a high-precision autofocus system, it may be unable to focus on the subjects listed below. If the camera is unable to focus, focus on another subject at the same distance and use focus lock to recompose the photograph.

- Very shiny subjects such as mirrors or car bodies.
- Fast-moving subjects.
- Subjects photographed through a window or other reflective object.
- Dark subjects and subjects that absorb rather than reflect light, such as hair or fur.
- Insubstantial subjects, such as smoke or flame.
- Subjects that show little contrast with the background (for example, subjects in clothing that is the same color as the background).
- Subjects positioned in front of or behind a high-contrast object that is also in the focus frame (for example, a subject photographed against a backdrop of highly contrasting elements).

## Exposure Compensation

To adjust exposure compensation when photographing very bright, very dark, or high-contrast subjects, press the selector up () or down () to choose an exposure compensation value and then press **MENU/OK**.

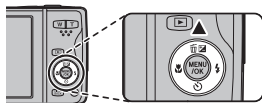



*Choose positive (+) values  
to increase exposure*



*Choose negative (-) values  
to reduce exposure*

- ❖ A  icon and exposure indicator are displayed at settings other than  $\pm 0$ . Exposure compensation is not reset when the camera is turned off; to restore normal exposure control, choose a value of  $\pm 0$ .
- ❖ Turn the flash off when using exposure compensation.
- ❖ Exposure compensation is available only when **P** (PROGRAM AE) is selected for shooting mode.

## Macro Mode (Close-ups)

For close-ups, press the selector left () and select . When macro mode is in effect, the camera focuses on subjects near the center of the frame. Use the zoom buttons to compose pictures ( 17).

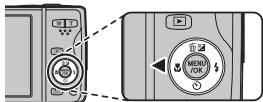

To exit macro mode, press the selector left () and select

 OFF.

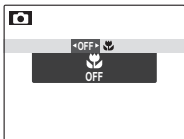





- ◆ Use of a tripod is recommended to prevent blur caused by camera shake.

## ⚡ Using the Flash (Intelligent Flash)

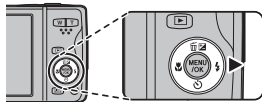
When the flash is used, the camera's *Intelligent Flash* system instantly analyzes the scene based on such factors as the brightness of the subject, its position in the frame, and its distance from the camera. Flash output and sensitivity are adjusted to ensure that the main subject is correctly exposed while preserving the effects of ambient background lighting, even in dimly-lit indoor scenes. Use the flash when lighting is poor, for example when shooting at night or indoors under low light.

Press the selector right (▶) and choose from the following flash modes:



Option	Description
<b>AUTO</b> /  (AUTO FLASH)	The flash fires when required. Recommended in most situations.
<b>⚡</b> /  (FORCED FLASH)	The flash fires whenever a picture is taken. Use for backlit subjects or for natural coloration when shooting in bright light.
 (SUPPRESSED FLASH)	The flash does not fire even when the subject is poorly lit. Use of a tripod is recommended.
<b>S4</b> /  (SLOW SYNCHRO)	Capture both the main subject and the background under low light (note that brightly lit scenes may be overexposed).



- ◆ If the flash will fire, ⚡ will be displayed when the shutter button is pressed halfway. At slow shutter speeds, 📷 will appear in the display to warn that pictures may be blurred; use of a tripod is recommended.
- ◆ The flash may fire several times with each shot. Do not move the camera until shooting is complete.
- ◆ The flash may cause vignetting.



**RED EYE REDUCTION** /



**FORCED FLASH** /



**RED EYE & SLOW**

👁 icon indicates that Intelligent Face Detection and red-eye removal are on and will be used to minimize “*red-eye*” caused by the flash reflecting from the retinas of portrait subjects.



## Using the Self-Timer

To use the self-timer, press the selector down (⏻) and choose from the following options:

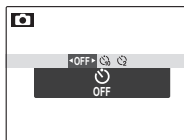
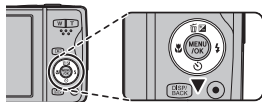

Option	Description
⏻ (OFF)	Self-timer off.
⏻ (10 SEC)	The shutter is released ten seconds after the shutter button is pressed. Use for self-portraits. The self-timer lamp on the front of the camera blinks while the timer counts down.
⏻ (2 SEC)	The shutter is released two seconds after the shutter button is pressed. Use to reduce blur caused by the camera moving when the shutter-release button is pressed. The self-timer lamp will blink as the timer counts down.

## Intelligent Face Detection

Intelligent Face Detection sets focus and exposure for human faces anywhere in the frame, preventing the camera from focusing on the background in group portraits. Choose for shots that emphasize portrait subjects.

To use Intelligent Face Detection, press **MENU/OK** to display the shooting menu and select **ON** for  **FACE DETECTION**. Faces can be detected with the camera in vertical or horizontal orientation; if a face is detected, it will be indicated by a green border. If there is more than one face in the frame, the camera will select the face closest to the center; other faces are indicated by white borders.

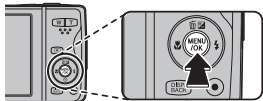

- ❗ In some modes, the camera may set exposure for the frame as a whole rather than the portrait subject.
- ❗ If the subject moves as the shutter button is pressed, their face may not be in the area indicated by the green border when the picture is taken.

## More on Playback

### Playback Options

To view the most recent picture in the LCD monitor, press the  button.

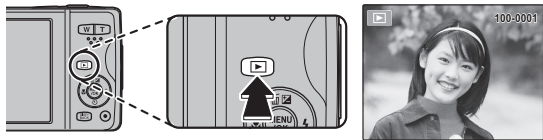

Press the selector right to view pictures in the order recorded, left to view pictures in reverse order. Keep the selector pressed to scroll rapidly to the desired frame.

◆ Pictures taken using other cameras are indicated by a  ("gift image") icon during playback.

### ★ Favorites: Rating Pictures

To rate the picture currently displayed in full-frame playback, press **DISP/BACK** and press the selector up and down to select from zero to five stars.

## **Playback Zoom**

Press **T** to zoom in on pictures displayed in single-frame playback; press **W** to zoom out. When the picture is zoomed in, the selector can be used to view areas of the image not currently visible in the display.

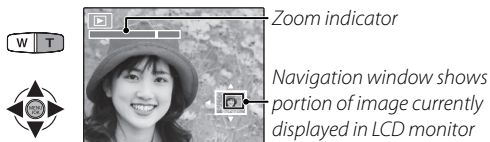

Press **DISP/BACK** to exit zoom.

- ◆ The maximum zoom ratio varies with image size. Playback zoom is not available with cropped or resized copies saved at a size of **640** or smaller.

**Multi-Frame Playback**

Pressing **W** when a picture is shown full-frame in the LCD monitor displays the current image with previous and following images in the background. Press **W** to increase the number of images displayed to two, nine, or one hundred, **T** to view fewer images.

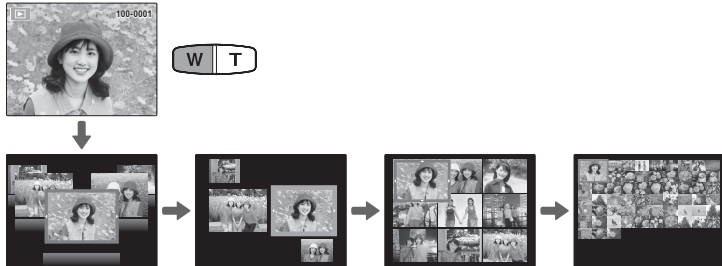

When two or more images are displayed, use the selector to highlight images and press **MENU/OK** to view the highlighted image full frame. In the nine- and hundred-frame displays, use the selector to view more pictures.

## Deleting Pictures

To delete individual pictures, multiple selected pictures, or all pictures, press **MENU/OK**, select  **ERASE** (📖 58), and choose from the options below. *Note that deleted pictures can not be recovered. Copy important pictures to a computer or other storage device before proceeding.*

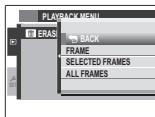









Option	Description
<b>FRAME</b>	Press the selector left or right to scroll through pictures and press <b>MENU/OK</b> to delete the current picture (a confirmation dialog is not displayed).
<b>SELECTED FRAMES</b>	Highlight pictures and press <b>MENU/OK</b> to select or deselect (pictures that are protected or in a print order are shown by  ). When the operation is complete, press <b>DISP/BACK</b> to display a confirmation dialog, then highlight <b>OK</b> and press <b>MENU/OK</b> to delete the selected pictures.
<b>ALL FRAMES</b>	A confirmation dialog will be displayed; highlight <b>OK</b> and press <b>MENU/OK</b> to delete all unprotected pictures. Pressing <b>DISP/BACK</b> cancels deletion; note that any pictures deleted before the button was pressed can not be recovered.

- ❖ Protected pictures can not be deleted. Remove protection from any pictures you wish to delete (📖 62).
- ❖ If a message appears stating that the selected images are part of a DPOF print order, press **MENU/OK** to delete the pictures.

## Image Search

---

Search for pictures.

- 1 Select  **IMAGE SEARCH** in the playback menu ( 58), highlight one of the following search criteria, and press **MENU/OK**:
  - **BY DATE**: Search by date.
  - **BY FACE**: Search for faces from the face recognition database.
  - **BY ★ FAVORITES**: Search by rating.
  - **BY SCENE**: Search by scene.
  - **BY TYPE OF DATA**: Find all still pictures or all movies.
  - **BY UPLOAD MARK**: Find all pictures selected for upload to a specified destination.
- 2 Select a search condition. Only pictures that match the search condition will be displayed. To delete or protect selected pictures or to view the search results in a slide show, press **MENU/OK** and choose  **ERASE** ( 33),  **PROTECT** ( 62), or  **SLIDE SHOW** ( 61).







## PhotoBook Assist

---

Create books from your favorite photos.

### ***Creating a PhotoBook***

- 1 Select **NEW BOOK** for  **PHOTOBOOK ASSIST** in the playback menu ( 58) and choose from the following options:
    - **SELECT FROM ALL:** Choose from all available pictures.
    - **SELECT BY IMAGE SEARCH:** Choose from pictures matching selected search conditions ( 34).
      - ◆ Neither photographs  or smaller nor movies can be selected for photobooks.
  - 2 Scroll through the images and press the selector up to select or deselect. To display the current image on the cover, press the selector down. Press **MENU/OK** to exit when the book is complete.
    - ◆ The first picture selected becomes the cover image. Press the selector down to select a different image for the cover.
  - 3 Select **COMPLETE PHOTOBOOK** (to select all photos or all photos matching the specified search conditions for the book, choose **SELECT ALL**). The new book will be added to the list in the photobook assist menu.
- ⓘ Books can contain up to 300 pictures.
- ⓘ Books that contain no photos are automatically deleted.

### **Viewing Photobooks**

Highlight a book in the photobook assist menu and press **MENU/OK** to display the book, then press the selector left or right to scroll through the pictures.

### **Editing and Deleting Photobooks**

Display the photobook and press **MENU/OK**. The following options will be displayed; select the desired option and follow the on-screen instructions.

- **EDIT:** Edit the book as described in “Creating a PhotoBook” (📖 35).
- **ERASE:** Delete the book.





#### **Photobooks**

Photobooks can be copied to a computer using the supplied MyFinePix Studio software.

# Movies

## Recording Movies

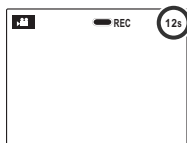
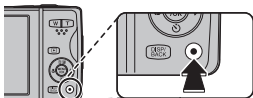

Press  to shoot a movie. During recording,  **REC** and the time remaining will be displayed in the LCD monitor and sound will be recorded via the built-in microphone (be careful not to cover the microphone during recording).



*Time available is displayed in monitor*

To end recording, press the  button again. Recording ends automatically when the movie reaches maximum length or memory is full.

### **Zoom adjustment**

Zoom can be adjusted while recording is in progress. Select the type of zoom available for  **MOVIE ZOOM TYPE** in the setup menu. Selecting  **OPTICAL** blocks sound being recorded when zooming.

- ◆ Before recording, select a frame size using the **MOVIE MODE** option in the shooting menu. Select **HD 1280** (1280 × 720) for an aspect ratio of 16:9 (High Definition), **640** (640 × 480) to record standard definition movies, or **320** (320 × 240) for longer movies.
- ◆ Focus, exposure, and white balance are adjusted automatically throughout recording. The color and brightness of the image may vary from that displayed before recording begins.
- ◆ Sounds made by the camera may be recorded.
- ① Do not open the battery-chamber cover during shooting or saving a movie on a memory card. Failure to observe this precaution could prevent the movie from being played back.
- ① Vertical or horizontal streaks may appear in movies containing very bright subjects. This is normal and does not indicate a malfunction.
- ① The temperature of the camera may rise if it is used to record movies for an extended period or if the ambient temperature is high. This is normal and does not indicate a malfunction.

## Viewing Movies

During playback, movies are displayed in the LCD monitor as shown at right. The following operations can be performed while a movie is displayed:

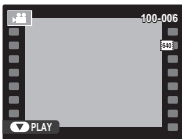

Option	Description
Start/pause playback	<b>Press the selector down</b> to start playback. Press again to pause.
End playback/delete	<b>Press the selector up</b> to end playback. If playback is not in progress, pressing the selector up will delete the movie.
Advance/rewind	<b>Press the selector right</b> to advance, <b>left</b> to rewind. If playback is paused, the movie will advance or rewind one frame each time the selector is pressed.
Adjust volume	<b>Press MENU/OK</b> to pause playback and display volume controls. Press the selector up or down to adjust the volume and press <b>MENU/OK</b> to exit. Volume can also be adjusted from the setup menu.

ⓘ Do not cover the speaker during playback.

## Connections

### Viewing Pictures on TV

Connect the camera to a TV to show pictures to a group.

- 1 Turn the camera off and connect an optional A/V cable as shown below.

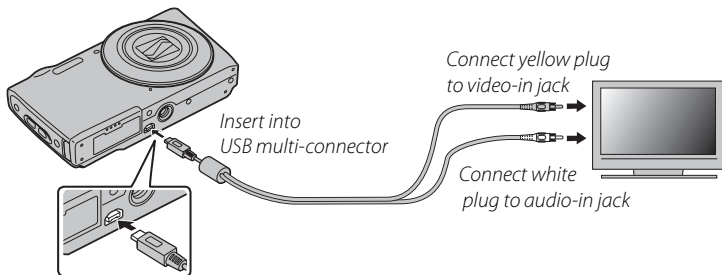

- ① When connecting cables, be sure the connectors are fully inserted.
  - ◆ Image quality may drop during movie playback.
  - ◆ To view high definition movies on a high definition TV, the optional accessory is required (📖 72, 73).
- 2 Tune the television to the video input channel. See the documentation supplied with the television for details.
- 3 Press the **▶** button for about a second to turn the camera on. The camera monitor turns off and pictures and movies are played back on the TV. Note that the camera volume controls have no effect on sounds played on the TV; use the television volume controls to adjust the volume.

## Printing Pictures via USB

If the printer supports PictBridge, the camera can be connected directly to the printer as shown below and pictures can be printed without first being copied to a computer. Note that depending on the printer, not all the functions described below may be supported.



- 1 Connect the supplied USB cable as shown and turn the printer on.

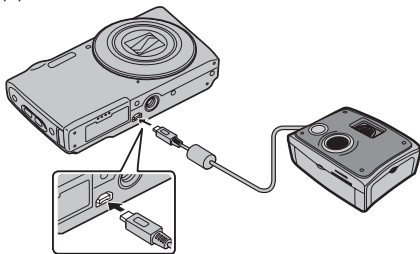

- 2 Turn the camera on.
- 3 Press the selector left or right to display a picture you wish to print.
- 4 Press the selector up or down to choose the number of copies (up to 99).
- 5 Repeat steps 3–4 to select additional pictures. Press **MENU/OK** to display a confirmation dialog when settings are complete.

**6** Press **MENU/OK** to start printing. Printing can be interrupted by pressing **DISP/BACK**, but note that some printers may not respond immediately. If the printer stops before printing is complete, turn the camera off and then on again.

**7** After confirming that **PRINTING** has cleared from the camera display, turn the camera off and disconnect the USB cable.

- ◆ Pictures can be printed from a memory card that has been formatted in the camera.
- ◆ If no pictures are selected, the camera will print one copy of the current picture.
- ◆ Page size, print quality, and border selections are made using the printer.

#### **Printing the Date of Recording**

To print the date of recording on pictures, press **DISP/BACK** in the PictBridge display and select **PRINT WITH DATE**  in the PictBridge menu (to print pictures without the date of recording, select **PRINT WITHOUT DATE**).





### ***Printing the DPOF Print Order***

The  **PRINT ORDER (DPOF)** option in the playback menu can be used to create a digital “print order” for PictBridge-compatible printers (📖 72) or devices that support DPOF.

#### **DPOF**

DPOF (Digital Print Order Format) is a standard that allows pictures to be printed from “print orders” stored on a memory card. The information in the order includes the pictures to be printed and the number of copies of each picture.



- 1 Select playback mode and press **MENU/OK** to display the playback menu.
- 2 Highlight  **PRINT ORDER (DPOF)** and press **MENU/OK**.
- 3 Highlight one of the following options and press **MENU/OK**:
  - **WITH DATE** : Print the date of recording on pictures.
  - **WITHOUT DATE**: Do not print the date of recording on pictures.

 Some printers do not support date printing. See the printer manual for details.
- 4 Press the selector left or right to display a picture you wish to add to or remove from the print order.

- 5** Press the selector up or down to choose the number of copies (up to 99). To remove a picture from the print order, press the selector down until the number of copies is zero.
- 6** Repeat Steps 4–5 to complete the print order and press **MENU/OK** when settings are complete.
- 7** A confirmation dialog will be displayed. Press **MENU/OK** to save the print order.
  - ◆ Print orders can contain a maximum of 999 pictures.
  - ◆ If a memory card is inserted containing a print order created by another camera, a message will be displayed. Create a new print order as described above.

## Viewing Pictures on a Computer

The supplied software can be used to copy pictures to a computer, where they can be stored, viewed, organized, and printed. Before proceeding, install the software as described below. **Do not connect the camera to the computer until installation is complete.**

### ***Windows: Installing MyFinePix Studio***

- 1 Confirm that the computer meets the following system requirements:

	Windows 7 (SP 1)/Windows Vista (SP 2) <sup>1</sup>	Windows XP (SP 3) <sup>1</sup>
<b>CPU</b>	3 GHz Pentium 4 or better (2.4 GHz Core 2 Duo or better) <sup>2</sup>	2 GHz Pentium 4 or better (2.4 GHz Core 2 Duo or better) <sup>2</sup>
<b>RAM</b>	1 GB or more	512 MB or more (1 GB or more) <sup>2</sup>
<b>Free disk space</b>	2 GB or more	
<b>GPU</b>	Supports DirectX 9 or later (recommended)	Supports DirectX 7 or later (required; performance not guaranteed with other GPUs)
<b>Video</b>	• 1024 × 768 pixels or more with 24-bit color or better	
<b>Other</b>	• Built-in USB port recommended. Operation is not guaranteed with other USB ports. • Internet connection (broadband recommended) required to install .NET Framework (if necessary), to use auto update feature, and when performing such tasks as sharing pictures on-line or via e-mail. • Installation of .Net Framework 3.5 SP1 required to use upload picture feature and MapViewer.	

- 1 Other versions of Windows are not supported. Only pre-installed operating systems are supported; operation is not guaranteed on home-built computers or computers that have been upgraded from earlier versions of Windows.
- 2 Recommended when displaying HD movies.

- 2 Start the computer. Log in to an account with administrator privileges before proceeding.

- 3 Exit any applications that may be running and insert the installer CD in a CD-ROM drive.

 **Windows 7/Windows Vista**

If an AutoPlay dialog is displayed, click **SETUP.EXE**. A “User Account Control” dialog will then be displayed; click **Yes** (Windows 7) or **Allow** (Windows Vista).

The installer will start automatically; click **Install MyFinePix Studio** and follow the on-screen instructions to install MyFinePix Studio.

 **If the Installer Does Not Start Automatically**

If the installer does not start automatically, select **Computer** or **My Computer** from the Start menu, then double-click the **FINEPIX** CD icon to open the FINEPIX CD window and double-click **setup** or **SETUP.EXE**.

- 4 If prompted to install Windows Media Player or DirectX, follow the on-screen instructions to complete installation.
- 5 Remove the installer CD from the CD-ROM drive when installation is complete. Store the installer CD in a dry location out of direct sunlight in case you need to re-install the software.

Installation is now complete. Proceed to “Connecting the Camera” (📖 49).

**Macintosh: Installing FinePixViewer**

- 1 Confirm that the computer meets the following system requirements:

<b>CPU</b>	PowerPC or Intel (Core 2 Duo or better)*
<b>OS</b>	Pre-installed copies of Mac OS X version 10.3.9–10.6. Mac OS X 10.7 is not supported. (visit <a href="http://www.fujifilm.com/support/digital_cameras/compatibility/">http://www.fujifilm.com/support/digital_cameras/compatibility/</a> for more information)
<b>RAM</b>	256 MB or more (1 GB or more)*
<b>Free disk space</b>	A minimum of 200 MB required for installation with 400 MB available when FinePixViewer is running
<b>Video</b>	800 × 600 pixels or more with thousands of colors or better
<b>Other</b>	Built-in USB port recommended. Operation is not guaranteed with other USB ports.

\* Recommended when displaying HD movies.

- 2 After starting the computer and quitting any applications that may be running, insert the installer CD in a CD-ROM drive and double-click **Installer for Mac OS X**.
- 3 An installer dialog will be displayed; click **Installing FinePixViewer** to start installation. Enter an administrator name and password when prompted and click **OK**, then follow the on-screen instructions to install FinePixViewer. Click **Exit** to quit the installer when installation is complete.



**4** Remove the installer CD from the CD-ROM drive. Note that you may be unable to remove the CD if Safari is running; if necessary, quit Safari before removing the CD. Store the installer CD in a dry location out of direct sunlight in case you need to re-install the software.

**5 Mac OS X 10.5 or earlier:** Open the “Applications” folder, start Image Capture, and select **Preferences...** from the Image Capture application menu. The Image Capture preferences dialog will be displayed; choose **Other...** in the **When a camera is connected, open** menu, then select **FPVBridge** in the “Applications/FinePixViewer” folder and click **Open**. Quit Image Capture.

**Mac OS X 10.6:** Connect the camera and turn it on. Open the “Applications” folder and start Image Capture. The camera will be listed under **DEVICES**; select the camera and choose **FPVBridge** from the **Connecting this camera opens** menu and click **Choose**. Quit Image Capture.

Installation is now complete. Proceed to “Connecting the Camera” (🗨️ 49).

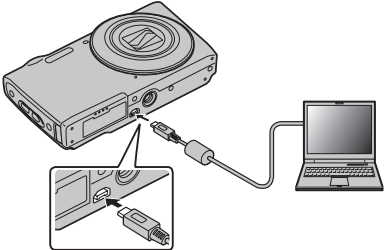
## **Connecting the Camera**

- 1** If the pictures you wish to copy are stored on a memory card, insert the card into the camera.
  - ◆ Windows users may require the Windows CD when starting the software for the first time.
  - ① Loss of power during transfer could result in loss of data or damage to the memory card. Charge the battery before connecting the camera.
- 2** Turn the camera off and connect the supplied USB cable as shown, making sure the connectors are fully inserted. Connect the camera directly to the computer; do not use a USB hub or keyboard.
- 3** Press the  button for about a second to turn the camera on. After starting MyFinePix Studio or FinePixViewer, follow the on-screen instructions to copy pictures to the computer. To exit without copying pictures, click **Cancel**.

For more information on using the supplied software, start the application and select the appropriate option from the **Help** menu.

- ❗ If a memory card containing a large number of images is inserted, there may be a delay before the software starts and you may be unable to import or save images. Use a memory card reader to transfer pictures.
- ❗ Make sure that the computer does not display a message stating that copying is in progress before turning the camera off or disconnecting the USB cable. Failure to observe this precaution could result in loss of data or damage to the memory card.
- ❗ Disconnect the camera before inserting or removing memory cards.
- ❗ In some cases, it may not be possible to access pictures saved to a network server using the supplied software in the same way as on a standalone computer.
- ❗ The user bears all applicable fees charged by the phone company or Internet service provider when using services that require an Internet connection.



 **Uninstalling the Supplied Software**

Only uninstall the supplied software when it is no longer required or before beginning reinstallation. After quitting the software and disconnecting the camera, drag the “FinePixViewer” folder from “Applications” into the Trash and select **Empty Trash** in the **Finder** menu (Macintosh), or open the control panel and use “Programs and Features” (Windows 7/Windows Vista) or “Add or Remove Programs” (Windows XP) to uninstall MyFinePix Studio. Under Windows, one or more confirmation dialogs may be displayed; read the contents carefully before clicking **OK**.

# Menus

## Using the Menus: Shooting Mode

### Using the Shooting Menu

To display the shooting menu, press **MENU/OK** in shooting mode. Highlight items and press the selector right to view options, then highlight an option and press **MENU/OK**. Press **DISP/BACK** to exit when settings are complete. The options available vary with the shooting mode selected.

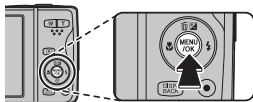

### Shooting Menu Options

#### SHOOTING MODE

(defaults to **S.R. AUTO**)

Choose a shooting mode according to the type of subject (📖 20).

#### ISO

(defaults to **AUTO**)

Control the camera's sensitivity to light. Higher values can reduce blur; note, however, that mottling may appear in pictures taken at high sensitivities.



Option	Description
<b>AUTO</b>	Sensitivity is adjusted automatically in response to shooting conditions.
<b>3200/1600/800/400/200/100</b>	Sensitivity is set to the specified value, which is shown in the display.

## IMAGE SIZE

(defaults to **L** 4:3)

Choose the image size and aspect ratio at which pictures are recorded. Large pictures can be printed at large sizes with no drop in quality, while small pictures require less memory, allowing more pictures to be recorded.



### Size Versus Aspect Ratio

#### Size

Option	Prints at sizes up to
<b>L</b>	34×25 cm (13.5×10 in.)
<b>M</b>	24×18 cm (9.5×7 in.)
<b>S</b>	17×13 cm (7×5 in.)

#### Aspect ratio

**4:3:** Pictures have the same proportions as the camera display.

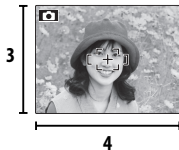

**3:2:** Pictures have the same proportions as a frame of 35 mm film.

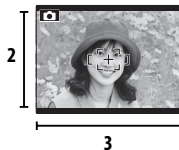

**16:9:** Suited for display on High Definition (HD) devices.

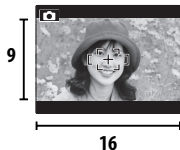



**IMAGE QUALITY**(defaults to **N**)

Choose how much image files are compressed.

Option	Description
<b>FINE</b>	Low compression. Select for higher image quality.
<b>NORMAL</b>	High compression. Select this option to store more pictures.

**FINEPIX COLOR**(defaults to **STDP**)







Enhance contrast and color saturation or take pictures in black and white.

Option	Description
 <b>STANDARD</b>	Standard contrast and saturation. Recommended in most situations.
 <b>CHROME</b>	Vivid contrast and color. Choose for vivid shots of flowers or enhanced greens and blues in landscapes.
 <b>B&amp;W</b>	Take pictures in black and white.

- ◆ Settings other than  **STANDARD** are shown by an icon in the LCD monitor.
- ◆ Depending on the subject, the effects of  **CHROME** may not be visible in the LCD monitor.

**WB WHITE BALANCE****(defaults to AUTO)**

For natural colors, choose a setting that matches the light source.

Option	Description
<b>AUTO</b>	White balance adjusted automatically.
	For subjects in direct sunlight.
	For subjects in the shade.
	Use under "daylight" fluorescent lights.
	Use under "warm white" fluorescent lights.
	Use under "cool white" fluorescent lights.
	Use under incandescent lighting.

- ◆ Results vary with shooting conditions. Play pictures back after shooting to check colors in the LCD monitor.

**CONTINUOUS****(defaults to OFF)**

Capture motion in a series of pictures.

Option	Description
 <b>TOP 3</b>	The camera takes up to 3 pictures while the shutter button is pressed.
<b>OFF</b>	One photograph is taken each time the shutter button is pressed.



- ◆ Focus and exposure are determined by the first frame in each series.
- ◆ The flash turns off automatically. The previously selected flash mode is restored when **OFF** is selected for  **CONTINUOUS**.
- ◆ Frame rate varies with shutter speed.
- ◆ The number of pictures that can be recorded depends on the memory available.

### FACE DETECTION

Choose whether the camera automatically detects and sets focus and exposure for human portrait subjects ( 29).

### AF MODE

This option controls how the camera selects the focus area. Regardless of the option selected, the camera will focus on the subject in the center of the LCD monitor when macro mode is on.

Option	Description
 CENTER	The camera focuses on the subject in the center of the frame.
 TRACKING	Position the subject in the center focus area and press the selector left. Focus will track the subject as it moves through the frame.

- ◆ Note that in  mode, the camera focuses continuously, increasing the drain on the batteries, and that the sound of the camera focusing may be audible.
-

 **MOVIE MODE**

(defaults to **HD**)

Choose a frame size for movies ( 38).

## Using the Menus: Playback Mode

---

### ***Using the Playback Menu***

To display the playback menu, press **MENU/OK** in playback mode. Highlight items and press the selector right to view options, then highlight an option and press **MENU/OK**. Press **DISP/BACK** to exit when settings are complete.

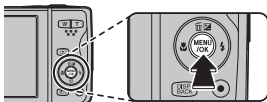

### ***Playback Menu Options***

#### **PHOTOBOOK ASSIST**

Create books from your favorite photos (📖 35).

#### **IMAGE SEARCH**

Search for pictures (📖 34).

#### **ERASE**

Delete all or selected pictures (📖 33).

---



 **MOVIE EDIT**

Edit movies.



**MOVIE TRIMMING**

Remove opening or ending footage to create an edited copy of the current movie.

- 1 Display the desired movie.
- 2 Select  **MOVIE EDIT** in the playback menu, then select **MOVIE TRIMMING**. To remove footage from the start of the copy, proceed to Step 3; otherwise, proceed to Step 4.
- 3 Press the selector down to begin playback and press it down again when the new opening frame is reached.
- 4 Press **MENU/OK**. To remove footage from the end of the copy, proceed to Step 5; otherwise, proceed to Step 6 (to exit without creating an edited copy, press **DISP/BACK**).
- 5 Press the selector down to begin playback and press it down again when the new closing frame is reached.
- 6 Press **MENU/OK** to save the copy.

**MOVIE JOIN**

Add existing footage to the end of the current movie to create an edited copy.

- 1 Display the desired movie.
  - 2 Select  **MOVIE EDIT** in the playback menu, then select **MOVIE JOIN**.
  - 3 Press the selector left or right to highlight a movie.
  - 4 Press **MENU/OK** to add the highlighted footage to the end of the current movie and save the resulting copy, or press **DISP/BACK** to exit without creating a copy.
-  Both movies must have been recorded at the same frame size and frame rate and have a combined file size of no more than 2 GB.

## MARK FOR UPLOAD TO

Select pictures for upload to YouTube or Facebook using MyFinePix Studio (Windows only).

### ■ Selecting Pictures for Upload

**1** Select **YouTube** to choose movies for upload to YouTube, **FACEBOOK** to choose photos and movies for upload to Facebook.

**2** Press the selector left or right to display pictures and press **MENU/OK** to select or deselect. Press **DISP/BACK** to exit when all the desired pictures are selected.

 Only movies can be selected for upload to YouTube.

 During playback, selected pictures are indicated by  **YouTube** or  **FACEBOOK** icons.

### ■ RESET ALL: Deselecting All Pictures

Choose **RESET ALL** to deselect all pictures. If the number of pictures affected is very large, a message will be displayed while the operation is in progress. Press **DISP/BACK** to exit before the operation is complete.

### ■ Uploading Pictures (Windows Only)

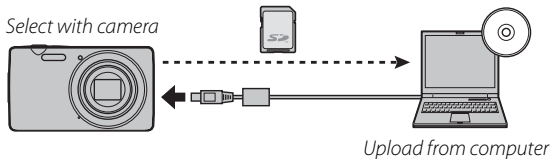

Selected pictures can be uploaded using the **YouTube/Facebook Upload** option in MyFinePix Studio.



For information on installing MyFinePix Studio and connecting the camera to a computer, see "Viewing Pictures on a Computer" (📖 45).

**SLIDE SHOW**(defaults to **MULTIPLE**)

View pictures in an automated slide show. Choose the type of show and press **MENU/OK** to start. Press **DISP/BACK** at any time during the show to view on-screen help. The show can be ended at any time by pressing **MENU/OK**.



Option	Description
<b>NORMAL</b>	Press selector left or right to go back or skip ahead one frame. Select <b>FADE-IN</b> for fade transitions between frames.
<b>FADE-IN</b>	
<b>NORMAL</b> 	As above, except that camera automatically zooms in on faces selected with Intelligent Face detection.
<b>FADE-IN</b> 	
<b>MULTIPLE</b>	Display several pictures at once.

❖ The camera will not turn off automatically while a slide show is in progress.

**RED EYE REMOVAL**



If the current picture is marked with a  icon to indicate that it was taken with Intelligent Face Detection, this option can be used to remove red-eye. The camera will analyze the image; if red-eye is detected, the image will be processed to create a copy with reduced red-eye.

- 1 Display the desired picture.
- 2 Select  **RED EYE REMOVAL** in the playback menu.
- 3 Press **MENU/OK**.

- ❖ Red eye may not be removed if the camera is unable to detect a face or the face is in profile. Results may differ depending on the scene. Red eye can not be removed from pictures that have already been processed using red-eye removal or pictures created with other devices.
- ❖ The amount of time needed to process the image varies with the number of faces detected.
- ❖ Copies created with  **RED EYE REMOVAL** are indicated by a  icon during playback.

### PROTECT

Protect pictures from accidental deletion.

- 1 Select  **PROTECT** in the playback menu.
  - 2 Highlight one of the following options and press **MENU/OK**:
    - **FRAME**: Protect selected pictures. Press the selector left or right to view pictures and press **MENU/OK** to select or deselect. Press **DISP/BACK** when the operation is complete.
    - **SET ALL**: Protect all pictures.
    - **RESET ALL**: Remove protection from all pictures.
- ① Protected pictures will be deleted when the memory card is formatted ( 66).

### CROP

Create a cropped copy of the current picture.

- 1 Display the desired picture.
  - 2 Select  **CROP** in the playback menu.
  - 3 Use the zoom buttons to zoom in and out and use the selector to scroll the picture until the desired portion is displayed.
  - 4 Press **MENU/OK** to display a confirmation dialog.
  - 5 Press **MENU/OK** again to save the cropped copy to a separate file.
- ◆ Larger crops produce larger copies; all copies have an aspect ratio of 4:3. If the size of the final copy will be **640**, **OK** will be displayed in yellow.

 **RESIZE**

Create a small copy of the current picture.

- 1 Display the desired picture.
  - 2 Select  **RESIZE** in the playback menu.
  - 3 Highlight a size and press **MENU/OK** to display a confirmation dialog.
  - 4 Press **MENU/OK** to save the resized copy to a separate file.
- ◆ The sizes available vary with the size of the original image.

 **IMAGE ROTATE**

Rotate pictures taken in tall orientation so that they are displayed in tall orientation in the LCD monitor.

- 1 Display the desired picture.
  - 2 Select  **IMAGE ROTATE** in the playback menu.
  - 3 Press the selector down to rotate the picture 90° clockwise, up to rotate it 90° counterclockwise.
  - 4 Press **MENU/OK**. The picture automatically be displayed in the selected orientation whenever it is played back on the camera.
- ◆ Protected pictures can not be rotated. Remove protection before rotating pictures (📖 62).
- ◆ The camera may not be able to rotate pictures created with other devices.

 **PRINT ORDER (DPOF)**

Select pictures for printing on DPOF- and PictBridge-compatible devices (📖 43).

# The Setup Menu

## Using the Setup Menu

1 Display the setup menu.

1.1 Press **MENU/OK** to display the menu for the current mode.

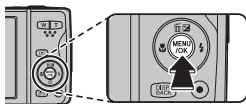

1.2 Press the selector left to highlight the tab for the current menu.

1.3 Press the selector down to highlight  **SET**.

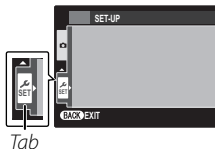

1.4 Press the selector right to place the cursor in the setup menu.

2 Adjust settings.

Highlight items and press the selector right to view options, then highlight an option and press **MENU/OK**. Press **DISP/BACK** to exit when settings are complete.

## ***Setup Menu Options***

### **DATE/TIME**



Set the camera clock (🗨️ 15).





### **TIME DIFFERENCE**

(defaults to )

Switch the camera clock instantly from your home time zone to the local time at your destination when traveling. To specify the difference between local time and your home time zone:

- 1 Highlight  **LOCAL** and press the selector right.
- 2 Use the selector to choose the time difference between local time and your home time zone.
- 3 Press **MENU/OK**.

To switch between local time and your home time zone, highlight  **LOCAL** or  **HOME** and press **MENU/OK**.

Option	Description
 <b>HOME</b>	Switch to the time currently selected for  <b>DATE/TIME</b> (see above).
 <b>LOCAL</b>	Switch to local time. If this option is selected,  and the time and date will be displayed in yellow for three seconds each time the camera is turned on.

### **言語/LANG.**

(defaults to **ENGLISH**)

Choose a language (🗨️ 92).

### **SILENT MODE**

(defaults to **OFF**)

Select **ON** to disable the speaker and flash in situations in which camera sounds or lights may be unwelcome (note that the flash will still fire in  mode).

### **RESET**

Reset all settings except  **DATE/TIME**,  **TIME DIFFERENCE**,  **BACKGROUND COLOR**, and  **VIDEO SYSTEM** to default values.

**1** Highlight  **RESET** and press the selector right to display a confirmation dialog.

**2** Highlight **OK** and press **MENU/OK**.

### **FORMAT**

This option will format the memory card.

- ⓘ All data—including protected pictures—will be deleted from the memory card. Be sure important files have been copied to a computer or other storage device.
- ⓘ Do not open the battery-chamber cover during formatting.

### **IMAGE DISP.**

(defaults to **1.5 SEC**)

Choose how long pictures are displayed in the LCD monitor after shooting.

Option	Description
<b>3 SEC</b>	Pictures are displayed for three seconds ( <b>3 SEC</b> ) or 1.5 seconds ( <b>1.5 SEC</b> ).
<b>1.5 SEC</b>	Colors may differ slightly from those in the final image.
<b>ZOOM (CONTINUOUS)</b>	Pictures are displayed until the <b>MENU/OK</b> button is pressed.
<b>OFF</b>	Pictures are not displayed after shooting.

- ◆ **OFF** has no effect in continuous shooting mode.



**FRAME NO.**(defaults to **CONT.**)

New pictures are stored in image files named using a four-digit file number assigned by adding one to the last file number used. The file number is displayed during playback as shown at right. **FRAME NO.** controls whether file numbering is reset to 0001 when a new memory card is inserted or the current memory card is formatted.

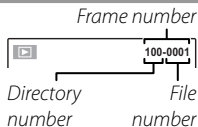

Option	Description
<b>CONTINUOUS</b>	Numbering continues from the last file number used or the first available file number, whichever is higher. Choose this option to reduce the number of pictures with duplicate file names.
<b>RENEW</b>	Numbering is reset to 0001 after formatting or when a new memory card is inserted.

- ❖ If the frame number reaches 999-9999, the shutter release will be disabled (📖 83).
- ❖ Selecting **RESET** (📖 66) sets **FRAME NO.** to **CONTINUOUS** but does not reset the file number.
- ❖ Frame numbers for pictures taken with other cameras may differ.

**OPERATION VOL.**(defaults to **OFF**)

Adjust the volume of the sounds produced when camera controls are operated. Choose **OFF** (mute) to disable control sounds.

**SHUTTER VOLUME**(defaults to **OFF**)

Adjust the volume of the sounds produced when the shutter is released. Choose **OFF** (mute) to disable the shutter sound.

### **SHUTTER SOUND** (defaults to 1)

Choose the sound made by the shutter.

### **PLAYBACK VOLUME** (defaults to 7)

Adjust the volume for movie playback.

### **LCD BRIGHTNESS** (defaults to 0)

Control the brightness of the display.

- ◆ When a shooting mode option other than **P** (PROGRAM AE) is selected, display brightness is automatically adjusted during shooting regardless of a option selected for  **LCD BRIGHTNESS** in response to ambient lighting conditions.

### **LCD MODE** (defaults to **ON**)

Choose whether the display automatically dims to save power.



### **AUTO POWER OFF** (defaults to 2 MIN)

Choose the length of time before the camera turns off automatically when no operations are performed. Shorter times increase battery life; if **OFF** is selected, the camera must be turned off manually. Note that in some situations the camera turns off automatically even when **OFF** is selected.

---

**DUAL IS MODE** (defaults to **OFF**)

Choose from the following image stabilization options:

Option	Description
 <b>CONTINUOUS</b>	Image stabilization on.
 <b>SHOOTING ONLY</b>	As above, except that image stabilization is performed only when the shutter button is pressed halfway or the shutter is released.
<b>OFF</b>	Image stabilization off. Choose this option when using a tripod.

**RED EYE REMOVAL** (defaults to **ON**)

Choose **ON** to remove red-eye effects caused by the flash when shooting with Intelligent Face Detection.

-  Red-eye reduction is performed only when a face is detected.

**DIGITAL ZOOM**

(defaults to **OFF**)

If **ON** is selected, pressing **T** button at the maximum optical zoom position will trigger digital zoom, further magnifying the image.

**The Zoom Indicator**

**DIGITAL ZOOM on**

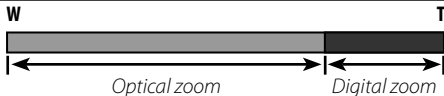

**DIGITAL ZOOM off**

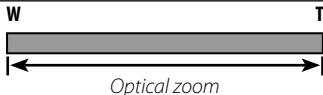

ⓘ Digital zoom produces lower quality images than optical zoom.

❖ Digital zoom can not be used when shooting in **SR Auto** mode.

**MOVIE ZOOM TYPE**

(defaults to **Di**)

Choose the zoom type when recording movies.

❖ Digital zoom produces lower quality images than optical zoom.

❖ Optical zoom blocks sound being recorded when zooming.

**SAVE ORG IMAGE**

(defaults to **OFF**)

Select **ON** to save unprocessed copies of pictures taken with red-eye removal.

**BACKGROUND COLOR**

Choose a color scheme.

**GUIDANCE DISPLAY**(defaults to **ON**)

Choose whether to display tool tips.

**VIDEO SYSTEM**

Choose a video mode for connection to a TV.

Option	Description
<b>NTSC</b>	Select this mode for connection to video devices in North America, the Caribbean, parts of Latin America, and some East Asian countries.
<b>PAL</b>	Select this mode for connection to video devices in the United Kingdom and much of Europe, Australia, New Zealand, and parts of Asia and Africa.

**DATE DATE STAMP**(defaults to **OFF**)

To add shooting date and time, choose **31** + . To add only shooting date, choose **31**. When **OFF** is selected, no information will be added to the pictures.

- ⓘ Added shooting date and time can not be deleted from the pictures. To take pictures without date and time, select **OFF** for **DATE DATE STAMP**.
- ⓘ When the camera clock is not set, setting dialog will be displayed. Set the date and time (📖 15).
- ⓘ When using **DATE DATE STAMP**, selecting **WITHOUT DATE** for **PRINT ORDER (DPOF)** is recommended (📖 43).
- ⓘ Date and time can not be added to the movies.

# Technical Notes

## Optional Accessories

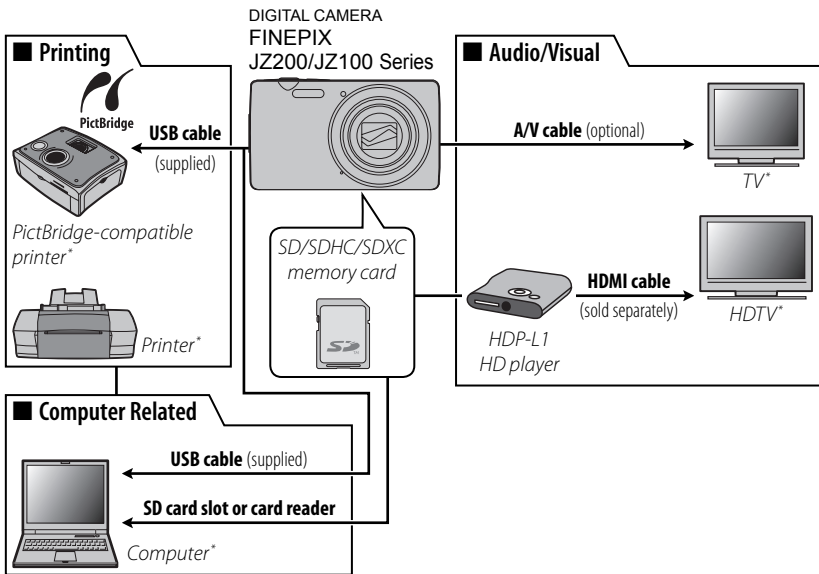

The camera supports a wide range of accessories from FUJIFILM and other manufacturers.



\* Available separately.

**Accessories from FUJIFILM**

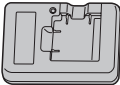
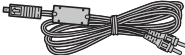
The following optional accessories are available from FUJIFILM. For the latest information on the accessories available in your region, check with your local FUJIFILM representative or visit [http://www.fujifilm.com/products/digital\\_cameras/index.html](http://www.fujifilm.com/products/digital_cameras/index.html).

<b>Rechargeable Li-ion batteries</b>	<b>NP-45A:</b> Additional large-capacity NP-45A rechargeable batteries can be purchased as required.	
<b>Battery chargers</b>	<b>BC-45W:</b> Replacement battery chargers can be purchased as required. The BC-45W charges an NP-45A/NP-45B battery in about 120 minutes at +20°C (+68°F).	
<b>A/V cable</b>	<b>AV-C1:</b> Use for viewing pictures on TV.	
<b>HD players</b>	<b>HDP-L1</b> (requires HDMI cable, available from third-party suppliers): Connect to a High Definition (HD) TV to view photographs and movies from SD/SDHC memory cards.	

## Caring for the Camera

---

To ensure continued enjoyment of the product, observe the following precautions.

### **Storage and Use**

If the camera will not be used for an extended period, remove the battery and memory card. Do not store or use the camera in locations that are:

- exposed to rain, steam, or smoke
- very humid or extremely dusty
- exposed to direct sunlight or very high temperatures, such as in a closed vehicle on a sunny day
- extremely cold
- subject to strong vibration
- exposed to strong magnetic fields, such as near a broadcasting antenna, power line, radar emitter, motor, transformer, or magnet
- in contact with volatile chemicals such as pesticides
- next to rubber or vinyl products

### ■ **Water and Sand**

Exposure to water and sand can also damage the camera and its internal circuitry and mechanisms. When using the camera at the beach or seaside, avoid exposing the camera to water or sand. Do not place the camera on a wet surface.

### ■ **Condensation**

Sudden increases in temperature, such as occur when entering a heated building on a cold day, can cause condensation inside the camera. If this occurs, turn the camera off and wait an hour before turning it on again. If condensation forms on the memory card, remove the card and wait for the condensation to dissipate.



**Cleaning**

Use a blower to remove dust from the lens and LCD monitor, then gently wipe with a soft, dry cloth. Any remaining stains can be removed by wiping gently with a piece of FUJIFILM lens-cleaning paper to which a small amount of lens-cleaning fluid has been applied. Care should be taken to avoid scratching the lens or LCD monitor. The camera body can be cleaned with a soft, dry cloth. Do not use alcohol, thinner, or other volatile chemicals.

**Traveling**

Keep the camera in your carry-on baggage. Checked baggage may suffer violent shocks that could damage the camera.

# Troubleshooting

## Problems and Solutions

### Power and Battery

Problem	Solution
The camera does not turn on.	<ul style="list-style-type: none"><li>• <b>The battery is exhausted:</b> Charge the battery (📖 6) or insert a fully-charged spare battery (📖 8).</li><li>• <b>The battery is inserted incorrectly:</b> Reinsert in the correct orientation (📖 8).</li><li>• <b>The battery-chamber cover is not latched:</b> Latch the battery-chamber cover (📖 8).</li></ul>
The battery runs down quickly.	<ul style="list-style-type: none"><li>• <b>The battery is cold:</b> Warm the battery by placing it in a pocket or other warm place and reinsert it in the camera immediately before taking a picture.</li><li>• <b>There is dirt on the battery terminals:</b> Clean the terminals with a soft, dry cloth.</li><li>• <b>SR is selected for shooting mode:</b> Select  mode to reduce the drain on the battery (📖 20).</li><li>• <b>TRACKING is selected for AF MODE:</b> Select a different AF mode (📖 56).</li><li>• <b>The battery has been charged many times:</b> The battery has reached the end of its charging life. Purchase a new battery.</li></ul>
The camera turns off suddenly.	Charge the battery (📖 6) or insert a fully-charged spare battery (📖 8).
Charging does not start.	Reinsert the battery in the correct orientation and make sure that the charger is plugged in (📖 6).
Charging is slow.	Charge the battery at room temperature (📖 vi).
The charging lamp lights, but the battery does not charge.	<ul style="list-style-type: none"><li>• <b>There is dirt on the battery terminals:</b> Clean the terminals with a soft, dry cloth.</li><li>• <b>The battery has been charged many times:</b> The battery has reached the end of its charging life. Purchase a new battery. If the battery still fails to charge, contact your FUJIFILM dealer.</li><li>• <b>The battery is too hot or too cold:</b> Wait for the battery temperature to stabilize.</li></ul>

## Menus and Displays

Problem	Solution
Menus and displays are not in English.	Select <b>ENGLISH</b> for  言語/LANG. (📖 15, 65).











## Shooting

Problem	Solution
No picture is taken when the shutter button is pressed.	<ul style="list-style-type: none"> <li>• <b>Memory is full:</b> Insert a new memory card or delete pictures (📖 9, 33).</li> <li>• <b>Memory is not formatted:</b> Format the memory card (📖 66).</li> <li>• <b>There is dirt on the memory card contacts:</b> Clean the contacts with a soft, dry cloth.</li> <li>• <b>The memory card is damaged:</b> Insert a new memory card (📖 9).</li> <li>• <b>The battery is exhausted:</b> Charge the battery (📖 6) or insert a fully-charged spare battery (📖 8).</li> <li>• <b>The camera has turned off automatically:</b> Turn the camera on (📖 13).</li> </ul>
The LCD monitor goes dark after shooting.	The LCD monitor may darken while the flash charges. Wait for the flash to charge (📖 26).
The camera does not focus.	<ul style="list-style-type: none"> <li>• <b>The subject is close to the camera:</b> Select macro mode (📖 25).</li> <li>• <b>The subject is far away from the camera:</b> Cancel macro mode (📖 25).</li> <li>• <b>The subject is not suited to autofocus:</b> Use focus lock (📖 22).</li> </ul>
Macro mode is not available	Choose a different shooting mode (📖 20).
Intelligent Face Detection is not available.	<b>Intelligent Face Detection is not available in the current shooting mode:</b> Choose a different shooting mode (📖 20).

Problem	Solution
No face is detected.	<ul style="list-style-type: none"> <li>• <b>The subject's face is obscured by sunglasses, a hat, long hair, or other objects:</b> Remove the obstructions.</li> <li>• <b>The subject's face occupies only a small area of the frame:</b> Change the composition so that the subject's face occupies a larger area of the frame (📖 22).</li> <li>• <b>The subject's head is tilted or horizontal:</b> Ask the subject to hold their head straight.</li> <li>• <b>The camera is tilted:</b> Keep the camera level (📖 17).</li> <li>• <b>The subject's face is poorly lit:</b> Shoot in bright light.</li> </ul>
Wrong subject is selected.	The selected subject is closer to the center of the frame than the main subject. Recompose the picture or turn face detection off and frame the picture using focus lock (📖 22).
The flash does not fire.	<ul style="list-style-type: none"> <li>• <b>The flash is not available in the current shooting mode:</b> Choose a different shooting mode (📖 20).</li> <li>• <b>The battery is exhausted:</b> Charge the battery (📖 6) or insert a fully-charged spare battery (📖 8).</li> <li>• <b>The camera is in continuous mode:</b> Select <b>OFF</b> for  <b>CONTINUOUS</b> (📖 55).</li> <li>• <b>The camera is in silent mode:</b> Turn silent mode off (📖 65).</li> <li>• <b>The flash is off (🔇):</b> Choose a different flash mode (📖 26).</li> </ul>
Some flash modes are not available.	<ul style="list-style-type: none"> <li>• <b>The desired flash mode is not available in the current shooting mode:</b> Choose a different shooting mode (📖 20).</li> <li>• <b>The camera is in silent mode:</b> Turn silent mode off (📖 65).</li> </ul>
The flash does not fully light the subject.	<ul style="list-style-type: none"> <li>• <b>The subject is not in range of the flash:</b> Position the subject in range of the flash (📖 92).</li> <li>• <b>The flash window is obstructed:</b> Hold the camera correctly (📖 17).</li> </ul>
Pictures are blurred.	<ul style="list-style-type: none"> <li>• <b>The lens is dirty:</b> Clean the lens (📖 75).</li> <li>• <b>The lens is blocked:</b> Keep objects away from the lens (📖 17).</li> <li>• <b>!AF is displayed during shooting and the focus frame is displayed in red:</b> Check focus before shooting (📖 81).</li> <li>• <b>!🔇 is displayed during shooting:</b> Use the flash or a tripod (📖 27).</li> </ul>

Problem	Solution
Pictures are mottled.	This is normal when slow shutter speeds are selected at high temperatures and does not indicate a malfunction.
Vertical lines appear in pictures.	The camera has been used continuously at high temperatures. Turn the camera off and wait for it to cool down.
"Smear" in the form of vertical purple or white lines appears in the display.	Vertical purple or white lines may appear after the camera has been used continuously at high temperatures or when a very bright object is in the frame; this phenomenon is common to all CCD image sensors and does not indicate a malfunction. These lines are recorded in movies but do not appear in photographs. Avoid framing bright objects when filming movies.

## Playback





Problem	Solution
Pictures are grainy.	The pictures were taken with a different make or model of camera.
Playback zoom is unavailable.	The pictures were created using  <b>RESIZE</b> or with a different make or model of camera.
No sound in movie playback.	<ul style="list-style-type: none"> <li>• <b>Playback volume is too low:</b> Adjust playback volume ( 68).</li> <li>• <b>The microphone was obstructed:</b> Hold the camera correctly during recording ( 17, 37).</li> <li>• <b>The speaker is obstructed:</b> Hold the camera correctly during playback ( 39).</li> <li>• <b>When  OPTICAL is selected for  MOVIE ZOOM TYPE, zooming blocks sound being recorded:</b> Select  <b>DIGITAL</b> for  <b>MOVIE ZOOM TYPE</b> ( 37).</li> </ul>
Selected pictures are not deleted.	Some of the pictures selected for deletion are protected. Remove protection using the device with which it was originally applied (  62).
File numbering is unexpectedly reset.	The battery-chamber cover was opened while the camera was on. Turn the camera off before opening the battery-chamber cover (  13).

## Connections/Miscellaneous

Problem	Solution
No picture or sound.	<ul style="list-style-type: none"> <li>• <b>The camera is not properly connected:</b> Connect the camera properly (📖 40).</li> <li>• <b>An A/V cable was connected during movie playback:</b> Connect the camera once movie playback has ended.</li> <li>• <b>Input on the television is set to “TV”:</b> Set input to “VIDEO”.</li> <li>• <b>The camera is not set to the correct video standard:</b> Match the camera <b>VIDEO SYSTEM</b> setting to the TV (📖 71).</li> <li>• <b>The volume on the TV is too low:</b> Adjust the volume.</li> </ul>
No color	Match the camera <b>VIDEO SYSTEM</b> setting to the TV (📖 71).
The computer does not recognize the camera.	Be sure the camera and computer are correctly connected (📖 49).
Pictures can not be printed.	<ul style="list-style-type: none"> <li>• <b>The camera is not properly connected:</b> Connect the camera correctly (📖 41).</li> <li>• <b>The printer is off:</b> Turn the printer on.</li> </ul>
Only one copy is printed/ the date is not printed.	The printer is not PictBridge compatible.
The camera is unresponsive.	<ul style="list-style-type: none"> <li>• <b>Temporary camera malfunction:</b> Remove and reinsert the battery (📖 8).</li> <li>• <b>The battery is exhausted:</b> Charge the battery (📖 6) or insert a fully-charged spare battery (📖 8).</li> </ul>
The camera does not function as expected.	Remove and reinsert the battery (📖 8). If the problem persists, contact your FUJIFILM dealer.
No sound.	Turn silent mode off (📖 65).
Date and time added by <b>DATE STAMP</b> are not correct.	<b>The camera clock is not correctly set:</b> Reset the date and time (📖 15).
Date and time are added to the pictures.	<b>[31] + 🕒 or [31] is selected for DATE DATE STAMP option:</b> Added shooting date and time can not be deleted from the pictures. To take pictures without date and time, select <b>OFF</b> for <b>DATE DATE STAMP</b> (📖 71).
FinePixViwer can not be installed or run.	FinePixViwer does not support Mac OS X 10.7 or later. Use the application supplied with Mac OS X or third-party software (📖 47).









## Warning Messages and Displays

The following warnings are displayed in the LCD monitor:

Warning	Description
 (red)	Low battery. Charge the battery ( 6 ) or insert a fully-charged spare battery ( 8 ).
 (blinks red)	Battery exhausted. Charge the battery ( 6 ) or insert a fully-charged spare battery ( 8 ).
	Slow shutter speed. Pictures may be blurred; use the flash or a tripod.
<b>!AF</b> (displayed in red with red focus frame)	The camera can not focus. Try one of the following solutions: <ul style="list-style-type: none"><li>• Use focus lock to focus on another subject at the same distance, then recompose the picture ( 22 ).</li><li>• Use macro mode to focus when taking close-ups ( 25 ).</li></ul>
Aperture or shutter speed displayed in red	The subject is too bright or too dark and the picture will be over- or under-exposed. If the subject is dark, use the flash ( 26 ).
FOCUS ERROR	Camera malfunction or moving parts of lens obstructed. Turn the camera off and then on again, taking care not to touch the lens. If the message persists, contact a FUJIFILM dealer.
TURN OFF THE CAMERA AND TURN ON AGAIN	
CARD NOT INITIALIZED	<ul style="list-style-type: none"><li>• <b>The memory card is not formatted or was formatted in a computer or other device:</b> Format the memory card using the  <b>FORMAT</b> option in the camera setup menu ( 66 ).</li><li>• <b>The memory card contacts require cleaning:</b> Clean the contacts with a soft, dry cloth. If the message is repeated, format the card ( 66 ). If the message persists, replace the card.</li><li>• <b>Camera malfunction:</b> Contact a FUJIFILM dealer.</li></ul>
PROTECTED CARD	The memory card is locked. Unlock the card ( 9 ).
BUSY	The memory card is incorrectly formatted. Use the camera to format the card ( 66 ).

Warning	Description
CARD ERROR	The memory card is not formatted for use in the camera. Format the card (📖 66).
	The memory card contacts require cleaning or the memory card is damaged. Clean the contacts with a soft, dry cloth. If the message is repeated, format the card (📖 66). If the message persists, replace the card.
	Incompatible memory card. Use a compatible card (📖 11).
	Camera malfunction. Contact a FUJIFILM dealer.
SD MEMORY FULL	The memory card is full and pictures can not be recorded or copied. Delete pictures or insert a memory card with more free space.
WRITE ERROR	<ul style="list-style-type: none"> <li>• <b>Memory card error or connection error:</b> Reinsert the card or turn the camera off and then on again. If the message persists, contact a FUJIFILM dealer.</li> <li>• <b>Not enough memory remaining to record additional pictures:</b> Delete pictures or insert a memory card with more free space.</li> <li>• <b>The memory card is not formatted:</b> Format the memory card (📖 66).</li> </ul>
READ ERROR	<ul style="list-style-type: none"> <li>• <b>The file is corrupt or was not created with the camera:</b> The file can not be viewed.</li> <li>• <b>The memory card contacts require cleaning:</b> Clean the contacts with a soft, dry cloth. If the message is repeated, format the card (📖 66). If the message persists, replace the card.</li> <li>• <b>Camera malfunction:</b> Contact a FUJIFILM dealer.</li> </ul>



Warning	Description
FRAME NO. FULL	The camera has run out of frame numbers (current frame number is 999-9999). Format the memory card and select <b>RENEW</b> for  <b>FRAME NO.</b> Take a picture to reset frame numbering to 100-0001, then select <b>CONTINUOUS</b> for  <b>FRAME NO.</b> (📖 67).
PRESS AND HOLD THE DISP BUTTON TO DEACTIVATE SILENT MODE	An attempt was made to choose a flash mode or adjust the volume with the camera in silent mode. Exit silent mode before choosing a flash mode or adjusting the volume (📖 65).
TOO MANY FRAMES	A search has returned more 5,000 results, or more than 999 frames were selected for deletion. Perform a different search or select fewer pictures.
PROTECTED FRAME	An attempt was made to delete or rotate to a protected picture. Remove protection and try again (📖 62).
 CAN NOT CROP	 pictures can not be cropped.
CAN NOT CROP	The picture is damaged or was not created with the camera.
 CANNOT EXECUTE	An attempt was made to create a resized copy at a size equal to or larger than the original. Choose a smaller size.
CAN NOT ROTATE	An attempt was made to rotate a picture that can not be rotated.
 CAN NOT ROTATE	Movies can not be rotated.
 CANNOT EXECUTE	Red-eye removal can not be applied to the selected picture.
 CANNOT EXECUTE	Red-eye removal can not be applied to movies.

Warning	Description
NO CARD INSERT A NEW CARD NO CARD	No memory card inserted; insert a memory card.
DPOF FILE ERROR	The DPOF print order on the current memory card contains more than 999 images.
CAN NOT SET DPOF	The picture can not be printed using DPOF.
 CAN NOT SET DPOF	Movies can not be printed using DPOF.
COMMUNICATION ERROR	A connection error occurred while pictures were being printed or copied to a computer or other device. Confirm that the device is turned on and that the USB cable is connected.
PRINTER ERROR	Printer out of paper or ink, or other printer error. Check printer (see printer manual for details). To resume printing, turn the printer off and then turn it back on.
PRINTER ERROR RESUME?	Printer out of paper or ink, or other printer error. Check printer (see printer manual for details). If printing does not resume automatically, press <b>MENU/OK</b> to resume.
CANNOT BE PRINTED	An attempt was made to print a movie, a picture not created with the camera, or a picture in a format not supported by the printer. Movies and some pictures created with other devices can not be printed; if the picture is a still picture created with the camera, check the printer manual to confirm that the printer supports the JFIF-JPEG or Exif-JPEG format. If it does not, the pictures can not be printed.

# Appendix





## Tips and Tricks

The following tips and tricks will help you get the most from your camera.



### Battery Performance

Choose the following settings for improved battery performance:

-  **FACE DETECTION** (📖 29): **OFF**
-  **AF MODE** (📖 56):  **CENTER**
-  **LCD MODE** (📖 68):  **POWER SAVE ON**



### The Self-timer

- **To prevent blur** caused by the camera moving when the shutter button is pressed, use the two-second timer.
- **To turn the timer off**, press **DISP/BACK**.





## Intelligent Face Detection

When **ON** is selected for  **FACE DETECTION** (📖 29), you can:

### Shooting

- **Zoom in on faces** when **ZOOM (CONTINUOUS)** is selected for  **IMAGE DISP.** (📖 66).





### Playback

- **Remove red-eye** by selecting **ON** for  **RED EYE REMOVAL** (📖 61).
- **Zoom in on faces** during slide shows (📖 61) or by pressing the selector down during playback.
- **Search for faces** using  **IMAGE SEARCH** (📖 34).
- **Crop** the background from portraits using  **CROP** (📖 62).

### Printing

- **Print** one copy for each person in the photo.

 **Pro Tips**

- To photograph backlit subjects, select  **NATURAL &**  for  **SHOOTING MODE** (📖 20) and position your subject in the center of the frame.
- To photograph subjects that are in motion, select  **TRACKING** for  **AF MODE** (📖 56).
- To photograph night scenes, raise sensitivity (📖 52) and turn the flash on (📖 26).



## Memory Card Capacity

The following table shows the recording time or number of pictures available at different image sizes. All figures are approximate; file size varies with the scene recorded, producing wide variations in the number of files that can be stored. The number of exposures or length remaining may not diminish at an even rate.

### ■ FinePix JZ200 series

Medium ☑		2 GB		4 GB		8 GB	
		FINE	NORMAL	FINE	NORMAL	FINE	NORMAL
Photographs	L 4:3	240	470	480	950	970	1910
	L 3:2	270	530	540	1060	1080	2130
	L 16:9	310	620	640	1250	1280	2510
	M 4:3	470	920	940	1840	1890	3680
	M 16:9	700	1340	1400	2690	2810	5380
	S 4:3	920	1740	1840	3490	3690	6980
	S 16:9	1680	3040	3360	6080	6720	12160
Movies*	HD 1280†	9 min.		18 min.		37 min.	
	640	27 min.		55 min.		111 min.	
	320	58 min.		116 min.		233 min.	

\* Individual movies can not exceed 2 GB in size or 29 minutes in length. If more than 2 GB are available, the camera will show the time remaining for a movie 2 GB in size.

† Use a CLASS 4 card or better when shooting HD movies.

## ■ FinePix JZ100 series

Medium ☛		2 GB		4 GB		8 GB	
		FINE	NORMAL	FINE	NORMAL	FINE	NORMAL
Photographs	<b>L 4:3</b>	270	540	550	1090	1110	2180
	<b>L 3:2</b>	310	610	620	1220	1240	2440
	<b>L 16:9</b>	360	710	730	1430	1470	2870
	<b>M 4:3</b>	530	1030	1060	2060	2130	4120
	<b>M 16:9</b>	700	1340	1400	2690	2810	5380
	<b>S 4:3</b>	1150	2140	2300	4290	4600	8580
	<b>S 16:9</b>	1680	3040	3360	6080	6720	12160
Movies*	<b>HD 1280†</b>	9 min.		18 min.		37 min.	
	<b>640</b>	27 min.		55 min.		111 min.	
	<b>320</b>	58 min.		116 min.		233 min.	

\* Individual movies can not exceed 2 GB in size or 29 minutes in length. If more than 2 GB are available, the camera will show the time remaining for a movie 2 GB in size.







† Use a **CLASS 4** card or better when shooting HD movies.

# Specifications

System	
<b>Model</b>	Digital Camera FinePix JZ200/JZ100 Series
<b>Effective pixels</b>	<b>FinePix JZ200 series</b> 16 million
	<b>FinePix JZ100 series</b> 14 million
<b>CCD</b>	1/2.3-in., square-pixel CCD with primary color filter
<b>Storage media</b>	SD/SDHC/SDXC memory cards
<b>File system</b>	Compliant with Design Rule for Camera File System (DCF), Exif 2.3, and Digital Print Order Format (DPOF)
<b>File format</b>	• <b>Still pictures:</b> Exif 2.3 JPEG (compressed) • <b>Movies:</b> AVI-format Motion JPEG
<b>Image size</b> (pixels)	<b>FinePix JZ200 series</b> • <b>L 4:3:</b> 4,608 × 3,456 • <b>L 3:2:</b> 4,608 × 3,072 • <b>L 16:9:</b> 4,608 × 2,592 • <b>M 4:3:</b> 3,264 × 2,448 • <b>M 16:9:</b> 3,072 × 1,728 • <b>S 4:3:</b> 2,304 × 1,728 • <b>S 16:9:</b> 1,920 × 1,080
	<b>FinePix JZ100 series</b> • <b>L 4:3:</b> 4,288 × 3,216 • <b>L 3:2:</b> 4,288 × 2,864 • <b>L 16:9:</b> 4,288 × 2,416 • <b>M 4:3:</b> 3,072 × 2,304 • <b>M 16:9:</b> 3,072 × 1,728 • <b>S 4:3:</b> 2,048 × 1,536 • <b>S 16:9:</b> 1,920 × 1,080
<b>Lens</b>	Fujinon 8 × optical zoom lens, F2.9 (wide angle) – F5.9 (telephoto)
<b>Focal length</b>	f=4.5 mm–36.0 mm (35-mm format equivalent: 25 mm–200 mm)
<b>Digital zoom</b>	<b>FinePix JZ200 series</b> Approx. 7.2 × (up to 57.6 × when combined with optical zoom)
	<b>FinePix JZ100 series</b> Approx. 6.7 × (up to 53.6 × when combined with optical zoom)



System	
<b>Aperture</b>	F2.9/F7.8 (wide angle), F5.9/F16.0 (telephoto); uses <b>Neutral Density (ND) filter</b>
<b>Focus range</b> (distance from front of lens)	Approx. 30 cm (0.9 ft.)–infinity (wide angle); 90 cm (2.9 ft.)–infinity (telephoto) <ul style="list-style-type: none"> <li>• <b>Macro:</b> approx. 5 cm–60 cm/1.9 in.–1.9 ft. (wide angle); 80 cm–1.2 m/2.6 ft.–3.9 ft. (telephoto)</li> </ul>
<b>Sensitivity</b>	Standard output sensitivity equivalent to ISO 100, 200, 400, 800, 1600, 3200 (image size <b>S</b> ); AUTO
<b>Metering</b>	256-segment through-the-lens (TTL) metering
<b>Exposure control</b>	Programmed AE
<b>Exposure compensation</b>	–2 EV – +2 EV in increments of 1/3 EV
<b>Picture stabilization</b>	Optical stabilization (lens-shift type)
<b>Shutter speed</b> (combined mechanical and electronic shutter)	<ul style="list-style-type: none"> <li>• <b>AUTO mode:</b> 1/4 s–1/2,000 s</li> <li>• <b>Other modes:</b> 8 s–1/2,000 s</li> </ul>
<b>Continuous</b>	<b>FinePix JZ200 series</b> Up to 0.7 fps; max. 3 frames  <b>FinePix JZ100 series</b> Up to 1.2 fps; max. 3 frames
<b>Focus</b>	<ul style="list-style-type: none"> <li>• <b>Mode:</b> Single AF, continuous AF</li> <li>• <b>Autofocus system:</b> Contrast-detect TTL AF</li> <li>• <b>Focus-area selection:</b> CENTER, TRACKING</li> </ul>
<b>White balance</b>	Automatic scene detection; six manual preset modes for direct sunlight, shade, daylight fluorescent, warm white fluorescent, cool white fluorescent, and incandescent
<b>Self-timer</b>	Off, 10 sec., 2 sec.

<b>System</b>	
<b>Flash</b>	CCD-metered auto flash control; effective range when sensitivity is set to <b>AUTO</b> is approx. 30 cm–3.0 m/0.9 ft.–9.8 ft. (wide angle), 90 cm–2.0 m/2.9 ft.–6.5 ft. (telephoto); effective range in macro mode is approx. 30 cm–60 cm/0.9 ft.–1.9 ft. (wide angle), 80 cm–1.2 m/2.6 ft.–3.9 ft. (telephoto)
<b>Flash mode</b>	<b>AUTO</b> ,  ,  , <b>S</b>  (red-eye removal off);  <b>AUTO</b> ,  ,  ,  (red-eye removal on)
<b>LCD monitor</b>	<b>FinePix JZ250 - JZ295 / JZ150 - JZ195</b> 3.0-in. (7.6 cm), 230k-dot color LCD monitor; frame coverage approx. 96% <b>FinePix JZ200 - JZ245 / JZ100 - JZ145</b> 2.7-in. (6.9 cm), 230k-dot color LCD monitor; frame coverage approx. 96%
<b>Movies</b>	Frame size 1,280 × 720, 640 × 480, 320 × 240; 30 fps; monaural sound
<b>Languages</b>	Arabic, Bulgarian, Simplified Chinese, Traditional Chinese, Czech, Danish, Dutch, English, Farsi, Finnish, French, German, Greek, Hebrew, Hungarian, Indonesian, Italian, Japanese, Kazakh, Korean, Latvian, Lithuanian, Norwegian, Polish, Portuguese, Romanian, Russian, Serbian, Slovak, Spanish, Swedish, Thai, Turkish, Ukrainian, Vietnamese
<b>Input/output terminals</b>	
<b>A/V OUT</b> (audio/video output)	NTSC or PAL output with monaural sound
<b>Digital input/output</b>	USB 2.0 High-Speed; shares A/V OUT connector; MTP/PTP

**Power supply/other****Power supply** NP-45A/NP-45B rechargeable battery**Battery life** (approximate number of frames that can be taken with a fully-charged battery)

Battery type	Approximate number of frames
NP-45A/NP-45B (type supplied with camera)	180

CIPA standard, measured in  (auto) mode using battery supplied with camera and SD memory card.

**Note:** Number of shots that can be taken with battery varies with battery charge level and will decline at low temperatures.

**Dimensions** (W × H × D)

100.3 mm × 55.9 mm × 23.9 mm/3.9 in. × 2.2 in. × 0.9 in.,  
excluding projections (minimum depth 18.3 mm/0.7 in.)

**Shooting weight****FinePix JZ250 - JZ295 / JZ150 - JZ195**

Approx. 135 g/4.7 oz., including battery and memory card

**FinePix JZ200 - JZ245 / JZ100 - JZ145**

Approx. 129 g/4.5 oz., including battery and memory card

**Weight****FinePix JZ250 - JZ295 / JZ150 - JZ195**

Approx. 118 g/4.1 oz., excluding battery, accessories, and memory card

**FinePix JZ200 - JZ245 / JZ100 - JZ145**

Approx. 112 g/3.9 oz., excluding battery, accessories, and memory card

**Operating conditions**

- **Temperature:** 0 °C – +40 °C/+32 °F – +104 °F
- **Humidity:** 10 % – 80 % (no condensation)

**NP-45A/NP-45B rechargeable battery**

<b>Nominal voltage</b>	DC 3.7 V
<b>Nominal capacity</b>	720 mAh
<b>Operating temperature</b>	0 °C – +40 °C/+32 °F – +104 °F
<b>Dimensions (W × H × D)</b>	31.0 mm × 39.6 mm × 6.0 mm/1.2 in. × 1.5 in. × 0.2 in.
<b>Weight</b>	Approx. 15.5 g/0.5 oz.

**BC-45B battery charger**

<b>Rated input</b>	100 V–240 V AC, 50/60 Hz
<b>Input capacity</b>	6.0 V (100 V/240 VA)
<b>Rated output</b>	4.2 V DC, 550 mA
<b>Supported batteries</b>	NP-45A/NP-45B rechargeable batteries
<b>Charging time</b>	Approx. 120 minutes (+20 °C/+68 °F)
<b>Operating temperature</b>	0 °C – +40 °C/+32 °F – +104 °F
<b>Dimensions (W × H × D)</b>	46 mm × 91 mm × 23 mm/1.8 in. × 3.6 in. × 0.9 in., excluding projections
<b>Weight</b>	Approx. 65 g/2.3 oz., excluding battery

Weight and dimensions may vary with the country or region of sale.

**■ Notices**

- Specifications subject to change without notice. FUJIFILM shall not be held liable for damages resulting from errors in this manual.
- Although the LCD monitor is manufactured using advanced high-precision technology, small bright points and anomalous colors may appear, particularly in the vicinity of text. This is normal for this type of LCD monitor and does not indicate a malfunction; images recorded with the camera are unaffected.
- Digital cameras may malfunction when exposed to strong radio interference (e.g., electric fields, static electricity, or line noise).
- Due to the type of lens used, some distortion may occur at the periphery of images. This is normal.

# Memo

---

---

---

---

---

---

---

---

---

---

---

---

---

---

---

---

---

---

---

---

---

---

---

---

---

---

---

---

---

---



# FUJIFILM

---

## **FUJIFILM Corporation**

7-3, AKASAKA 9-CHOME, MINATO-KU, TOKYO 107-0052, JAPAN

[http://www.fujifilm.com/products/digital\\_cameras/index.html](http://www.fujifilm.com/products/digital_cameras/index.html)

Please contact your local distributor for repairs and technical support. (see Worldwide Network list)





# Restrictions on Camera Settings

Option		Shooting Mode																			
				<b>P</b>																<b>TEXT</b>	
		✓	✓	✓	✓	✓	✓	✓	✓	✓	✓	✓	✓	✓	✓	✓	✓	✓	✓	✓	
			✓	✓	✓	✓					✓										
		✓	✓	✓	✓	✓	✓	✓	✓	✓	✓	✓	✓	✓	✓	✓	✓	✓	✓	✓	✓
<b>WB</b>			✓							✓											
	<b>ON</b>	✓	✓	✓		✓	✓	✓	✓	✓		✓	✓	✓	✓	✓	✓	✓	✓	✓	
	<b>OFF</b>	✓	✓	✓	1	✓	✓	✓	✓	✓	1	✓	✓	✓	✓	✓	✓	✓	✓	✓	✓
	<b>ON</b>	✓ <sup>1</sup>	✓	✓	✓	✓	✓	✓	✓ <sup>1</sup>			✓	✓		✓	✓	✓	✓			
	<b>OFF</b>		✓	✓	✓	✓	✓	✓		✓ <sup>1</sup>	✓ <sup>1</sup>	✓ <sup>1</sup>	✓	✓	✓ <sup>1</sup>	✓	✓	✓	✓	✓ <sup>1</sup>	✓ <sup>1</sup>
			✓	✓	✓ <sup>1</sup>	✓ <sup>1</sup>	✓ <sup>1</sup>	✓ <sup>1</sup>		✓ <sup>1</sup>	✓ <sup>1</sup>	✓ <sup>1</sup>	✓ <sup>1</sup>	✓ <sup>1</sup>	✓ <sup>1</sup>	✓ <sup>1</sup>	✓ <sup>1</sup>	✓ <sup>1</sup>	✓ <sup>1</sup>	✓ <sup>1</sup>	✓ <sup>1</sup>
		✓	✓																		
										✓											
	<b>HD 1280</b>																				✓
	<b>640</b>																				✓
	<b>320</b>																				✓
		✓	✓	✓	✓	✓	✓	✓	✓	✓	✓	✓	✓	✓	✓	✓	✓	✓	✓	✓	✓
		✓	✓	✓	✓	✓	✓	✓	✓	✓	✓	✓	✓	✓	✓	✓	✓	✓	✓	✓	✓
		✓	✓	✓	✓	✓	✓	✓	✓	✓	✓	✓	✓	✓	✓	✓	✓	✓	✓	✓	✓
		✓	✓	✓	✓	✓	✓	✓	✓	✓	✓	✓	✓	✓	✓	✓	✓	✓	✓	✓	✓
	<b>OFF</b>	✓	✓	✓	✓	✓	✓	✓	✓	✓	✓	✓	✓	✓	✓	✓	✓	✓	✓	✓	✓
		✓	✓	✓	✓	✓	✓	✓	✓		✓	✓	✓		✓	✓	✓	✓			
		✓	✓	✓	✓		✓					✓	✓		✓	✓	✓	✓			
			✓	✓	✓	✓	✓	✓	✓		✓	✓	✓	✓	✓	✓	✓	✓	✓	✓	✓

1 Automatically optimized for selected shooting mode.

2 The camera automatically analyzes and selects macro mode **ON/OFF**.

3 Aspect ratio fixed at **4:3**.