

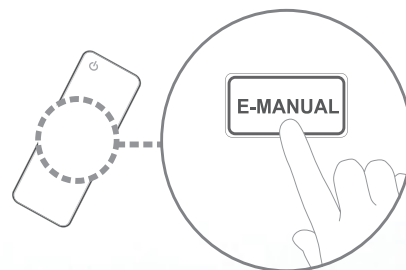

E-MANUAL



Thank you for purchasing this Samsung product. To receive more complete service, please register your product at www.samsung.com/register

Model _____ Serial No. _____

Contents

Channel Setting

- Using the INFO button (Now & Next guide) 1
- Using Channel menu 2
- Retuning Channels 17

Basic Features

- Changing the Preset Picture Mode 27
- Adjusting Picture Settings 28
- Changing the Picture Options 38
- Changing the Preset Sound Mode 45
- Adjusting Sound Settings 46
- Selecting the Sound Mode 56

Preference Features

- Connecting to the Network 57
- Setting the Wired Network 71
- Setting the Wireless Network 77
- Managing the Network Connected Devices 86
- Executing initial setup 90
- Setting the Time 91
- Using the Sleep Timer 93
- Setting the On / Off Timer 94
- Locking Programme 98
- Picture In Picture (PIP) 100
- Economical Solutions 102
- Other Features 105
- Support Menu 116

Advanced Features

- Using the 3D function 124
- Using the Media Contents 135
- Connecting a USB Device 136
- Connecting to the PC through network 142
- Screen Display 145
- Media Contents - Additional Functions 156
- Using the DLNA Functions 160

Other Information

- Teletext Feature 166
- Anti-theft Kensington Lock 170
- Connections Common Interface Slot 172
- Troubleshooting 174
- Licence 191

□ Using the INFO button (Now & Next guide)

The display identifies the current channel and the status of certain audio-video settings.

The Now & Next guide shows daily TV programme information for each channel according to the broadcasting time.

 When you press the **A** (**Information**) button, you can see the details of the programme.

- Scroll ◀, ▶ to view information for a desired programme while watching the current channel.
- Scroll ▲, ▼ to view information for other channels. If you want to move to the currently selected channel, press the **ENTER**  button.

□ Using Channel menu

 MENU  → Support → Contents Home → ENTER 

Press the **CONTENT** button to select the desired menu. Each screen will be displayed.

■ Channel List

You can view channel information, **All**, **TV**, **Radio**, **Data/Other**, **Analogue** or **Favourites 1-5**.

 When you press the **CH LIST** button on the remote control, **Channel List** screen will be displayed at once.

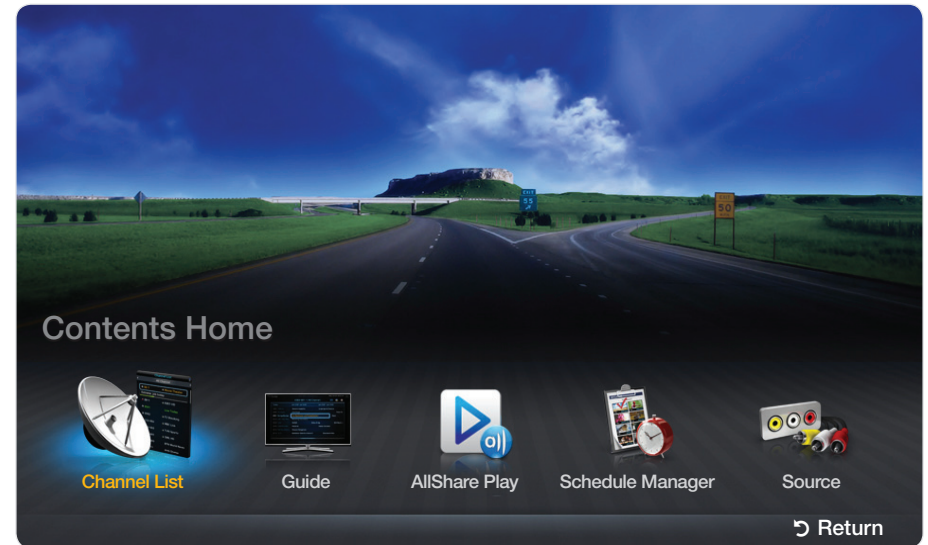



* The displayed image may differ depending on the model.

- **All**: Shows all currently available channels.
 - **TV**: Shows all currently available TV channels.
 - **Radio**: Shows all currently radio channels.
 - **Data/Other**: Shows all currently available MHP or other channels.
 - **Analogue**: Shows all currently available analogue channels.
 - **Favourites 1-5**: Shows all favourite channels.
-  If you want to view favourite channels you added, press the **CH LIST** button and use ◀▶ (**Ch. Mode**) button to move **Favourites 1-5**.





Using the control buttons with the **Channel List**.

-  (**Tools**): Displays the option menu.
-  (**Ch. Mode / Channel**): Move to the **All, TV, Radio, Data/Other, Analogue** or **Favourites 1-5**.





When you select the **Programme View** in  (**Tools**) menu, you can move to other channels using  (**Channel**) button.

-  (**Watch / Information**): Watches the channel you selected. / Displays details of the selected programme.
-  (**Page**): Move to next or previous page.

How to use Schedule Viewing in Channel List

(digital channels only)

When you set the **Schedule Viewing** in **Channel List**, you can only set the programme in **Programme View**.



1. Press the **CH LIST** button, then select a desired digital channel.
 2. Press **TOOLS** button, and then select the **Programme View**. The programme list for that channel appears.
 3. Press the ▲ / ▼ buttons to select the desired programme, then press the **ENTER**  (**Information**) or **INFO** button.
 4. Select **Schedule Viewing**, then press the **ENTER**  button when done.
-  If you want to cancel **Schedule Viewing**, follow steps 1 through 3. Select **Cancel schedule**.

Using Option Menu

Set each channel using the **Channel List** menu options (**Programme View, Edit Favourites, Lock/Unlock, Edit Channel Name, Edit Channel Number, Delete, Information, Sort, Edit Mode**).

Option menu items may differ depending on the channel status.

1. Select a channel and press the **TOOLS** button.
2. Select a function and change its settings.

- **Programme View**: Displays the programme when digital channel is selected.
- **Edit Favourites**: Set channels you watch frequently as favourites. Add or delete the selected channel in **Favourites 1-5**.
 1. Select the **Edit Favourites**, then press the **ENTER**  button.
 2. Press the **ENTER**  button to select **Favourites 1-5**, then press the **OK** button.
 -  One favourite channel can be added in several of favourites among **Favourites 1-5**.

- **Lock/Unlock:** Lock a channel so that the channel cannot be selected and viewed.
 - ☞ This function is available only when the **Channel Lock** is set to **On**.
 - ☞ The PIN input screen appears. Enter your 4-digit PIN. Change the PIN using the **Change PIN** option.
- **Edit Channel Name** (analogue channels only): Assign your own channel name.









- **Edit Channel Number:** Edit the number by pressing the number buttons desired.
 - ✎ Some area may not be able to support **Edit Channel Name** and **Edit Channel Number** function.
- **Delete:** You can delete a channel to display the channels you want.
- **Information:** Displays details of the selected programme.
- **Sort:** Changes the list ordered by channel number or channel name.

- **Edit Mode:** You can select desired channels and edit it.

Using Option Menu

Set each channel using the menu options (**Edit Favourites, Lock/Unlock, Delete, Deselect, Select All**).

1. Press the **TOOLS** button in **Channel List** screen, then select the **Edit Mode**. A check box appears to the left of the channel.
2. Press the ▲/▼ buttons to select the desired channel, then press the **ENTER**  button. The (✓) mark indicates the channel you've selected.
 -  You can select more than one channel.
 -  Press the **ENTER**  again to deselect the channel.
3. Press the **TOOLS** button, then select a function and change its settings.

- **Edit Favourites:** Set the selected channels you watch frequently as favourites.
 -  The **Edit Favourites** screen has five groups (**Favourites 1**, **Favourites 2**, etc.). You can add a favourite channel to any one of the groups. Press the ▲/▼ buttons to select a group.
- **Lock/Unlock:** Lock a channel so that the channel cannot be selected and viewed.
 -  This function is available only when the **Channel Lock** is set to **On**.
 -  The PIN input screen appears. Enter your 4-digit PIN. Change the PIN using the **Change PIN** option.
- **Delete:** You can delete a channel to display the channels you want.
- **Deselect:** Deselect the selected channels.
- **Select All:** Select all the channels in the channel list.

Guide

The EPG (Electronic Programme Guide) information is provided by broadcasters. Using programme schedules provided by broadcasters, you can specify programmes you want to watch in advance so that the channel automatically changes to the selected programme channel at the specified time. Programme entries may appear blank or out of date depending on a channel status.

Guide 18:15 Sat 1 May

Die Musik-Show
DTV Air 825 NDR FERNSEHEN
19:15 - 20:40
Dani is devastated when scot makes clear his views ...

825 NDR FERNSEHEN

Channel View - All



	Today	20:00	20:30	21:00	21:30
▲ 821	Kanal 5	No Information			
822	M6	No Information			
823	MDR FERNSEHEN	Musik fur Sie	MD...	Ein Schloss am ...	
824	Mediashopping	No Information			
825	NDR FERNSEHEN	Die Musik-Show	Die NDR Quizshow	Sportclub live	
▼ 826	NT1	No Information			

Sche. Mgr -24 Hours +24 Hours Ch. Mode Information Page Schedule

1 2 3 4 5 6 7

* The displayed image may differ depending on the model.

- ① **A** Red (**Sche. Mgr**): Moves to the reserved programmes in **Sche. Mgr**.
- ② **B** Green (**-24 Hours**): Viewing the list of programmes to be broadcasted before 24 hours.
- ③ **C** Yellow (**+24 Hours**): Viewing the list of programmes to be broadcasted after 24 hours.
- ④ **D** Blue (**Ch. Mode**): Select the type of channels you want to display on the **Channel List** window. (**All, TV, Radio, Data/Other, Favourites 1-5**)

- 5 *i* (**Information**): Displays details of the selected programme.
- 6  (**Page**): Move to previous or next page.
- 7  (**Watch / Schedule**)
 - When selecting the current programme, you can watch the selected programme.
 - When selecting the future programme, you can reserve to watch the selected programme. To cancel the schedule, press the **ENTER**  button again and select **Cancel schedule**.

■ Schedule Manager

You can set a desired channel to be displayed automatically at the intended time. In addition, you can view, modify or delete a channel you have reserved to watch. Set the current time first to use this function.

Using Option Menu

Set each channel using the menu options (**Cancel schedule, Edit Schedule, Schedule manually, View Guide**).

1. Press the **TOOLS** button to select the **Schedule manually**.

 You can press the **A** (**Schedule manually**) directly on the **Schedule Manager** screen.

2. Press the **◀/▶/▲/▼** or number buttons to set the **Antenna, Channel, Repeat, Date, Start Time**.

- **Antenna**: Select the desired broadcasting signal.
- **Channel**: Select the desired channel.

- **Repeat:** Select **Once, Manual, Sat~Sun, Mon~Fri** or **Everyday** to set at your convenience. If you select **Manual**, you can set the day you want.

 The (✓) mark indicates the day you've selected.

- **Date:** You can set the desired date.

 It is available when you select **Once** in **Repeat**.

- **Start Time:** You can set the start time you want.

 If you want to edit or cancel the schedule, select the reserved schedule on the **Reserved Programmes**. Press the **TOOLS** button, then select the **Edit Schedule** or **Cancel schedule**.

 If you select the **View Guide**, you can see the **Guide** screen.

❑ Retuning Channels

■ Aerial (Air / Cable) **TOOLS**

 **MENU**  → **Channel** → **Aerial** → **ENTER** 

Before your television can begin memorising the available channels, you must specify the type of signal source that is connected to the TV (i.e. an **Air** or **Cable** system).

■ Country

(depending on the country)



 **MENU**  → **Channel** → **Country** → **ENTER** 

The PIN input screen appears. Enter your 4 digit PIN number.

- **Digital Channel:** Change the country for digital channels.
- **Analogue Channel:** Change the country for analogue channels.

■ Auto Tuning

(depending on the country)

 **MENU**  → **Channel** → **Auto Tuning** → **ENTER** 

Scans for a channel automatically and stores in the TV.

 Automatically allocated programme numbers may not correspond to actual or desired programme numbers. If a channel is locked, the PIN input window appears.

- **Auto Tuning**

Air / Cable: Select the aerial source to memorise.

Digital & Analogue / Digital / Analogue: Select the channel source to memorise.

When Aerial Source is set to Air or Cable:

When selecting **Cable** → **Digital & Analogue** or **Digital**: Provide a value to scan for cable channels.

- **Operator Selection** (depending on the country): Selects a provider of cable services.
- **Search Mode (Full / Network / Quick)**: Scans for all channels with active broadcast stations and stores them in the TV.
 - ✎ If you select **Quick**, you can set up the **Network, Network ID, Frequency, Modulation** and **Symbol Rate** manually by pressing the button on the remote control.
- **Network (Auto / Manual)**: Selects the **Network ID** setting mode among **Auto** or **Manual**.
- **Network ID**: When **Network** is **Manual**, you can set up **Network ID** using the numeric buttons.

- **Frequency**: Displays the frequency for the channel. (differs in each country)
- **Modulation**: Displays available modulation values.
- **Symbol Rate**: Displays available symbol rates.
- **Cable Search Option**
(depending on the country & cable channels only)
Sets additional search options such as the frequency and symbol rate for a cable network search.
Start Frequency / Stop Frequency: Set the start or stop frequency (differs in each country).
Symbol Rate: Displays available symbol rates.
Modulation: Displays available modulation values.

■ Manual Tuning

 **MENU**  → **Channel** → **Manual Tuning** → **ENTER** 

Scans for a channel manually and stores in the TV.

 If a channel is locked, the PIN input window appears.

 According to the channel source, **Manual Tuning** may be supported.

When Aerial Source is set to Air or Cable:

- **Digital Channel Tuning**: Scans for a digital channel manually and stores in the TV. Press the **New** button to search the digital channels. When scanning has finished, a channel is updated in the channel list.
 - When selecting **Aerial** → **Air: Channel, Frequency, Bandwidth**
 - When selecting **Aerial** → **Cable: Frequency, Modulation, Symbol Rate**

- **Analogue Channel Tuning:** Scans for an analogue channel. Press the **New** button to search the channels by adjusting the **Programme, Colour System, Sound System, Channel, Search**.



Channel mode

- **P** (programme mode): When tuning is complete, the broadcasting stations in your area have been assigned to the position numbers from P0 to P99. You can select a channel by entering the position number in this mode.
- **C** (aerial channel mode) / **S** (cable channel mode): These two modes allow you to select a channel by entering the assigned number for each aerial broadcasting station or cable channel.

■ Transfer Channel List

(depending on the country)

 **MENU**  → **Channel** → **Transfer Channel List** → **ENTER** 



Imports or exports the channel map. You should connect a USB storage to use this function.

 The PIN number input screen appears. Enter your 4 digit PIN number.

- **Import from USB:** Import channel list from USB.
- **Export to USB:** Export channel list to USB.

■ Fine Tune

(analogue channels only)

 **MENU**  → **Channel** → **Fine Tune** → **ENTER** 

If the signal is weak or distorted, fine tune the channel manually.

 Fine tuned channels are marked with an asterisk “*”.

 To reset the fine-tuning, select **Reset**.

■ Edit Channel Number (Disable / Enable)

(depending on the country)

 **MENU**  → **Channel** → **Edit Channel Number** → **ENTER** 

Use this to change channel number. When channel number is changed, channel information is not updated automatically.

❑ Changing the Preset Picture Mode

 MENU  → **Picture** → **Picture Mode** → ENTER 

■ **Picture Mode**

Select your preferred picture type.

 When connecting a PC, you can only make changes to the **Entertain** and **Standard**.

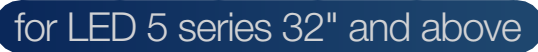
- **Dynamic**: Suitable for a bright room.
- **Standard**: Suitable for a normal environment.
- **Natural**  **for LED 5 series 32" and above**: Suitable for reducing eye strain.
- **Movie**: Suitable for watching movies in a dark room.
- **Entertain**: Suitable for watching movies and games.

 It is only available when connecting a PC.

❑ Adjusting Picture Settings

■ Samsung MagicAngle for LED 4 series 19", 5 series 22"

 MENU  → Picture → Samsung MagicAngle → ENTER 

Adjust screen viewing Angle to optimize screen quality according to your viewing position.

- **Samsung MagicAngle:** When viewing the screen at an angle from below or above by setting the appropriate mode for each position, you can obtain a similar picture quality as viewing the screen directly from the front.

Off: Select when viewing from the front position.

Lean Back Mode: Select when viewing from a slightly lower position.

Standing Mode: Select when viewing from the upper position.

- **Mode:** Adjust screen viewing angle.

 When **Samsung MagicAngle** is set to **Lean Back Mode** or **Standing Mode**, **Gamma** is not available.

■ Backlight for LED, LCD TV / Cell Light for PDP TV / Contrast / Brightness / Sharpness / Colour / Tint (G/R)

Your television has several setting options for picture quality control.

NOTE

- In analogue **TV, Ext., AV** modes of the PAL system, the **Tint (G/R)** function is not available. LCD 420 does not support AV, Component mode
- When connecting a PC, you can only make changes to **Backlight for LED, LCD TV / Cell Light for PDP TV, Contrast, Brightness** and **Sharpness**.
- Settings can be adjusted and stored for each external device connected to the TV.
- Lowering picture brightness reduces power consumption.

■ Screen Adjustment

 MENU  → **Picture** → **Screen Adjustment** → ENTER 

Set the various picture options such as picture size and aspect ratio.

- **Picture Size:** Your cable box/satellite receiver may have its own set of screen sizes as well. However, we highly recommend you use 16:9 mode most of the time.

Auto Wide: Automatically adjusts the picture size to the **16:9** aspect ratio.

16:9: Sets the picture to 16:9 wide mode.

Wide Zoom: Magnifies the picture size more than 4:3.

 Adjusts the **Position** by using ▲, ▼ buttons.

Zoom: Magnifies the 16:9 wide pictures vertically to fit the screen size.

 Adjusts the **Zoom** or **Position** by using ▲, ▼ button.

4:3: Sets the picture to basic (4:3) mode.

 Do not watch in 4:3 format for a long time. Traces of borders displayed on the left, right and centre of the screen may cause image retention (screen burn) which are not covered by the warranty.

Screen Fit: Displays the full image without any cut-off when HDMI (720p / 1080i / 1080p) or Component (1080i / 1080p) signals are inputted. **LCD 420 does not support AV, Component mode**

Smart View 1 for LED 5 series 32" and above: Reduces original screen by 50%.

Smart View 2 for LED 5 series 32" and above: Reduces original screen by 25%.



NOTE

- **Smart View 1** is enabled only in HDMI mode.
- **Smart View 2** is enabled only in DTV and HDMI modes.
- The picture size can vary depending on the input resolution when content is played using **Videos** under **Media Play**.
- **Position**: Adjust the picture position. It is only available in **Screen Fit** or **Wide Zoom**.

- **Zoom/Position**: Adjust the picture size and position. It is only available in **Zoom**.

 NOTE

- After selecting **Screen Fit** in HDMI (1080i / 1080p) or Component (1080i / 1080p) mode, you may need to centre the picture **LCD 420 does not support AV, Component mode**:
 1. Press the ▲ or ▼ button to select **Position**.
 2. Press the **ENTER**  button.
 3. Press the ▲, ▼, ◀ or ▶ button to move the picture.
- Depending on the input source, the picture size options may vary.
- If you want to reset the position you adjusted, select **Reset** in the **Position** screen. The picture will be set to its default position.

- The available items may differ depending on the selected mode.
- When connecting a PC, only **16:9** and **4:3** modes can be adjusted.
- Settings can be adjusted and stored for each external device connected to an input on the TV.
- If you use the **Screen Fit** function with HDMI 720p input, 1 line will be cut at the top, bottom, left and right as in the overscan function.
- **4:3 Screen Size (16:9 / Wide Zoom / Zoom / 4:3)**: Available only when picture size is set to **Auto Wide**. You can determine the desired picture size at the 4:3 WSS (Wide Screen Service) size or the original size. Each European country requires different picture size.

- **PC Screen Adjustment** for LED 4 series 19", 5 series 22"

 It is available in **PC** mode.

Coarse / Fine: Removes or reduces picture noise. If the noise is not removed by Fine-tuning alone, then adjust the frequency as best as possible (**Coarse**) and Fine-tune again. After the noise has been reduced, readjust the picture so that it is aligned to the centre of screen.

Position: Adjust the PC's screen positioning if it does not fit the TV screen. Press the ▲ or ▼ button to adjust the Vertical-Position. Press the ◀ or ▶ button to adjust the Horizontal-Position.

Image Reset: Resets the image to default settings.

Auto Adjustment

TOOLS 

for LED 4 series 19", 5 series 22"

 **MENU**  → **Picture** → **Auto Adjustment** → **ENTER** 

Adjust frequency values/positions and fine tune the settings automatically.

 It is available in **PC** mode.

 Not available when connecting with an HDMI/DVI cable.

Using Your TV as a Computer (PC) Display

Setting Up Your PC Software (Based on Windows OS)

Depending on the version of Windows and the video card, the actual screens on your PC may differ in which case the same basic set-up information will almost always be applied. (If not, contact your computer manufacturer or Samsung Dealer.)

To set screen resolution, click on the “Control Panel” on the Windows start menu, and then set the desired screen resolution in the “Display”.

 NOTE

- The correct size setting (Screen resolution)
 - [Optimum: 1366 X 768 pixels] **for LED 4 series**
 - [Optimum: 1920 X 1080 pixels] **for LED 5 series**
- If a vertical-frequency option exists on your display settings, the correct value is “60” or “60 Hz”.

❑ Changing the Picture Options

■ Advanced Settings

 **MENU**  → **Picture** → **Advanced Settings** → **ENTER** 

(available in **Standard / Movie** mode)

You can adjust the detailed setting for the screen including colour and contrast.

 When connecting a PC, you can only make changes to **Gamma** and **White Balance**. for LED 4 series 19", 5 series 22"

- **Dynamic Contrast (Off / Low / Medium / High):** Adjust the screen contrast.
- **Black Tone (Off / Dark / Darker / Darkest):** Select the black level to adjust the screen depth.
- **Flesh Tone:** Adjust the flesh tone colour.

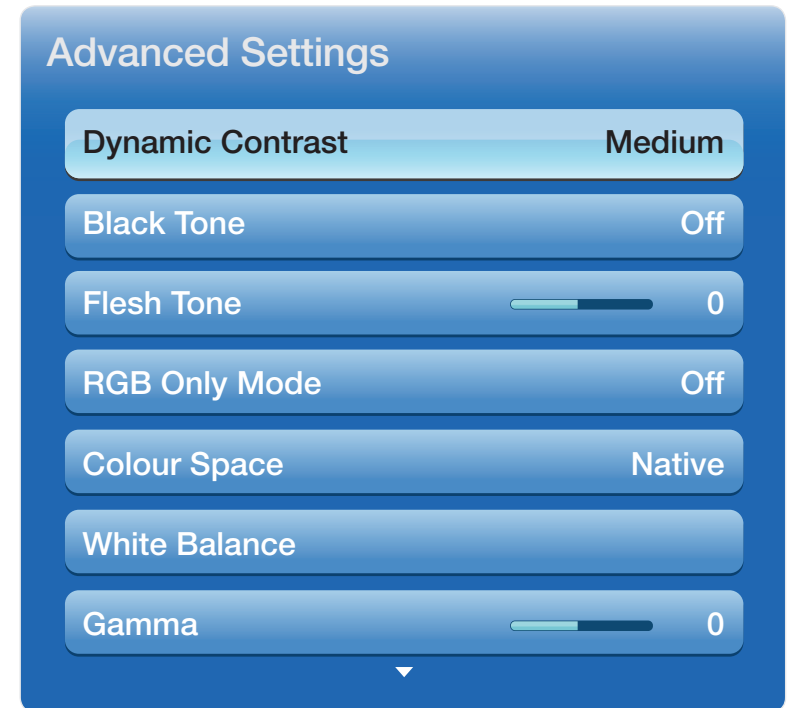

- **RGB Only Mode (Off / Red / Green / Blue):** Displays the Red, Green and Blue colour for making fine adjustments to the hue and saturation.
- **Colour Space (Auto / Native):** Adjust the range of colours available to create the image.

- **White Balance:** Adjust the colour temperature for a more natural picture.
R-Offset / G-Offset / B-Offset: Adjust each colour's (red, green, blue) darkness.
R-Gain / G-Gain / B-Gain: Adjust each colour's (red, green, blue) brightness.
Reset: Resets the **White Balance** to its default settings.
- **Gamma:** Adjust the primary colour intensity.
- **Motion Lighting (Off / On):** Reduce power consumption by brightness control adapted motion.



This function is not supported in **3D** mode. **for PDP 490 series**



Only available in **Standard** mode.



When changing a setting value of **Backlight** **for LED, LCD TV** / **Cell Light** **for PDP TV**, **Brightness** or **Contrast**, **Motion Lighting** will be set to **Off**.

■ Picture Options

 **MENU**  → **Picture** → **Picture Options** → **ENTER** 

 When connecting a PC, you can only make changes to the **Colour Tone**.

- **Colour Tone (Cool / Standard / Warm1 / Warm2)**

 **Warm1** or **Warm2** will be deactivated when the picture mode is **Dynamic**.

 Settings can be adjusted and stored for each external device connected to an input on the TV.

- **Digital Noise Filter (Off / Low / Medium / High / Auto / Auto Visualisation):**

If the broadcast signal received by your TV is weak, you can activate the **Digital Noise Filter** feature to reduce any static and ghosting that may appear on the screen.

 When the signal is weak, try other options until the best picture is displayed.

Auto Visualisation: When changing analogue channels, displays signal strength.

 Only available for analogue channels.

 When the **INFO** button is pressed, the signal strength bar is displayed.

 When bar is green, you are receiving the best possible signal.

- **MPEG Noise Filter (Off / Low / Medium / High / Auto)**: Reduces MPEG noise to provide improved picture quality.
- **HDMI Black Level (Low / Normal)**: Selects the black level on the screen to adjust the screen depth.
 - ✎ Available only in **HDMI** mode (RGB signals).
- **Film Mode (Off / Auto1 / Auto2)**: Sets the TV to automatically sense and process film signals from all sources and adjust the picture for optimum quality.
 - ✎ Available in TV mode, AV, Component (480i / 1080i) and HDMI (1080i). **LCD 420 does not support AV, Component mode**
 - ✎ If the screen does not seem natural, change its option to **Off / Auto1 / Auto2** in **Film Mode**.
- **LED Motion Plus (Off / On)** **for LED 5 series**: Removes drag from fast scenes with a lot of movement to provide a clear picture.
 - ✎ It will be deactivated when the picture mode is set to **Natural**.

■ Reset Picture (Yes / No)

 MENU  → **Picture** → **Reset Picture** → **ENTER** 

Resets your current picture mode to its default settings.



❑ Changing the Preset Sound Mode

■ Sound Mode **TOOLS**

 MENU  → **Sound** → **Sound Mode** → ENTER 

- **Standard**: Selects the normal sound mode.
- **Music**: Emphasizes music over voices.
- **Movie**: Provides the best sound for movies.
- **Clear Voice**: Emphasizes voices over other sounds.
- **Amplify**: Increase the intensity of high-frequency sound to allow a better listening experience for the hearing impaired.

 If **Speaker Select** is set to **External Speaker**, **Sound Mode** is disabled. **for LED, PDP TV**

□ Adjusting Sound Settings

■ Sound Effect

(standard sound mode only)

 **MENU**  → **Sound** → **Sound Effect** → **ENTER** 

Use the up and down arrow keys to select an option, and then press **ENTER** .

- **SRS TruSurround HD (Off / On)** **TOOLS** 

(standard sound mode only)

◀ This function provides a virtual 5.1 channel surround sound experience through a pair of speakers using HRTF (Head Related Transfer Function) technology. ▶

- **SRS TruDialog (Off / On)**

(standard sound mode only)

This function allows you to increase the intensity of a voice over background music or sound effects so that dialogue can be heard more clearly.

- **Equaliser**

Use Equaliser to customize sound setting for each speaker.

Balance: Adjusts the balance between the right and left speaker.

100Hz / 300Hz / 1kHz / 3kHz / 10kHz (Bandwidth Adjustment): Adjusts the level of specific bandwidth frequencies.

Reset: Resets the equaliser to its default settings.



If **Speaker Select** is set to **External Speaker**, **Sound Effect** is disabled. **for LED, PDP TV**

■ Broadcast Audio Options

 MENU  → Sound → Broadcast Audio Options → ENTER 

- **Audio Language** 

(digital channels only)

Change the default value for audio languages.

 The available language may differ depending on the broadcast.

- **Audio Format**

(digital channels only)

When sound is emitted from both the main speaker and the audio receiver, a sound echo may occur due to the decoding speed difference between the main speaker and the audio receiver. In this case, use the TV Speaker function.

 **Audio Format** option may differ depending on the broadcast. 5.1ch Dolby digital sound is only available when connecting an external speaker through an optical cable. **LCD 420 does not support**

- **Audio Description**

(not available in all locations) (digital channels only)

This function handles the Audio Stream for the AD (Audio Description) which is sent along with the Main audio from the broadcaster.



Audio Description (Off / On): Turn the audio description function on or off.

Volume: Adjust the audio description volume.



■ Additional Settings

 **MENU**  → **Sound** → **Additional Settings** → **ENTER** 

- **DTV Audio Level (MPEG / HE-AAC)** (digital channels only): This function allows you to reduce the disparity of a voice signal (which is one of the signals received during a digital TV broadcast) to a desired level.
 -  According to the type of broadcast signal, **MPEG / HE-AAC** can be adjusted between -10dB and 0dB.
 -  To increase or decrease the volume, adjust between the range 0 and -10 respectively.

- **SPDIF Output** **for LED, PDP TV**: SPDIF (Sony Philips Digital InterFace) is used to provide digital sound, reducing interference going to speakers and various digital devices such as a DVD player.

Audio Format: You can select the Digital Audio output (SPDIF) format. The available Digital Audio output (SPDIF) format may differ depending on the input source.

 By connecting to 5.1ch speakers in a Dolby Digital setup, maximize your interactive 3D sound experience.

Audio Delay: Correct audio-video sync problems, when watching TV or video, and when listening to digital audio output using an external device such as an AV receiver (0ms ~ 250ms).

- **Dolby Digital Comp (Line / RF)**: This function minimizes signal disparity between a dolby digital signal and a voice signal (i.e. MPEG Audio, HE-AAC, ATV Sound).

 Select **Line** to obtain dynamic sound, and **RF** to reduce the difference between loud and soft sounds at night time.

Line: Set the output level for signals greater or less than -31dB (reference) to either -20dB or -31dB.

RF: Set the output level for signals greater or less than -20dB (reference) to either -10dB or -20dB.

■ Speaker Settings

 MENU  → **Sound** → **Speaker Settings** → ENTER 

- **Speaker Select (External Speaker / TV Speaker)** for LED, PDP TV

A sound echo may occur due to a difference in decoding speed between the main speaker and the audio receiver. In this case, set the TV to **External Speaker**.

 When **Speaker Select** is set to **External Speaker**, the volume and **MUTE** buttons will not operate and the sound settings will be limited.

 When **Speaker Select** is set to **External Speaker**.

- **TV Speaker**: Off, **External Speaker**: On

 When **Speaker Select** is set to **TV Speaker**.

- **TV Speaker**: On, **External Speaker**: On

 If there is no video signal, both speakers will be mute.

- **Auto Volume (Off / Normal / Night)**

To equalize the volume level on each channel, set to **Normal**.

Night: This mode provides an improved sound experience compared to **Normal** mode, making almost no noise. It is useful at night.

- ☞ To use the volume control on the source device connected to the TV, set **Auto Volume** to **Off** on the TV. Otherwise, a change to the volume control of the source device may not be applied.

■ Reset Sound (Yes / No)

 MENU  → Sound → Reset Sound → ENTER 



Reset all sound settings to the factory defaults.



❑ Selecting the Sound Mode **TOOLS**

When you set to **Dual I-II**, the current sound mode is displayed on the screen.

	Audio Type	Dual I-II	Default
A2 Stereo	Mono	Mono	Automatic change
	Stereo	Stereo ↔ Mono	
	Dual	Dual I ↔ Dual II	Dual I
NICAM Stereo	Mono	Mono	Automatic change
	Stereo	Mono ↔ Stereo	
	Dual	Mono → Dual I ↖ Dual II ↙	Dual I

-  If the stereo signal is weak and an automatic switching, occurs, then switch to the mono.
-  Only activated in stereo sound signal.
-  Only available when the **Source** is set to **TV**.

❏ Connecting to the Network

for LED 5 series 32" and above, PDP 490 series

📖 For LED TVs, network function is not supported depending on the country.

■ Wired Network Connection

You can attach your TV to your LAN using cable in three ways:

- You can attach your TV to your LAN by connecting the LAN port on the back of your TV to an external modem using a LAN cable. See the diagram below.

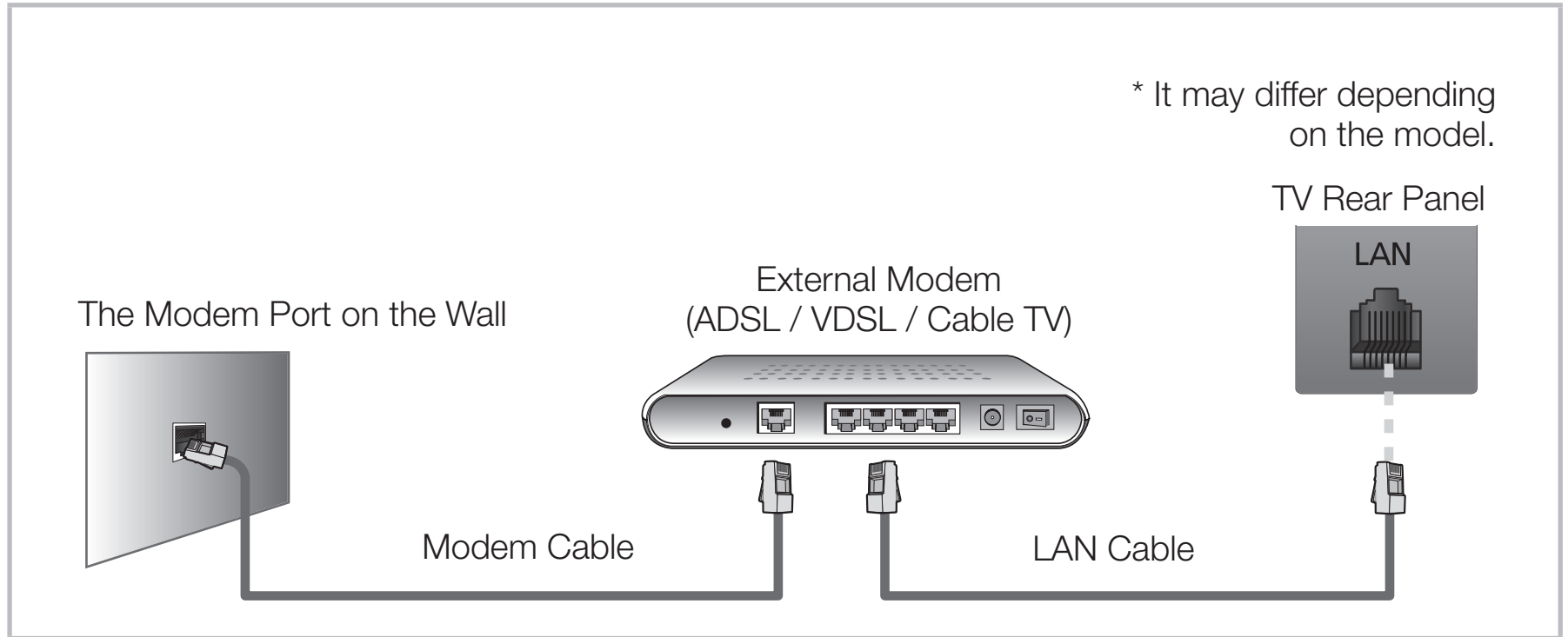

- You can attach your TV to your LAN by connecting the LAN port on the back of your TV to a IP Sharer which is connected to an external modem. Use LAN cable for the connection. See the diagram below.

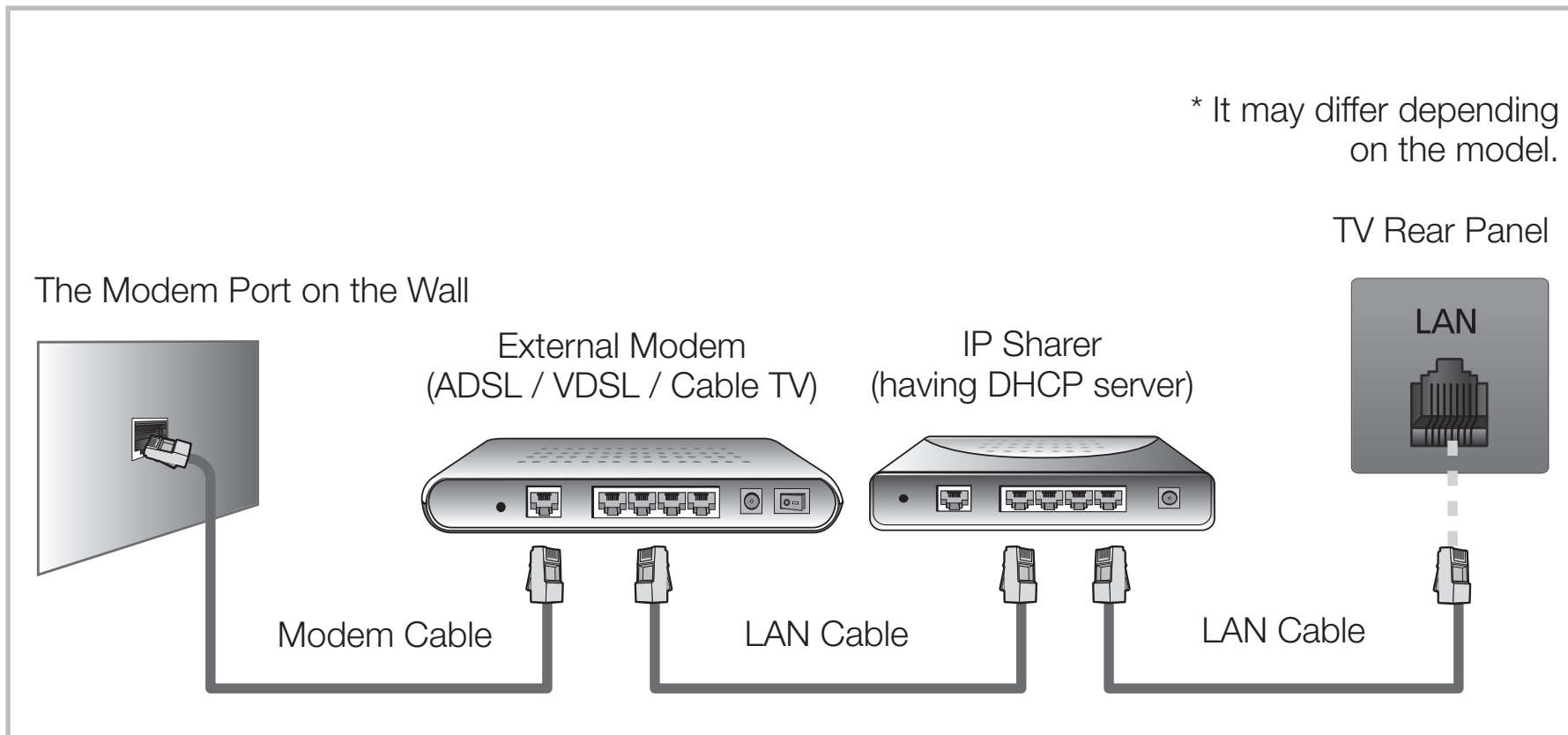

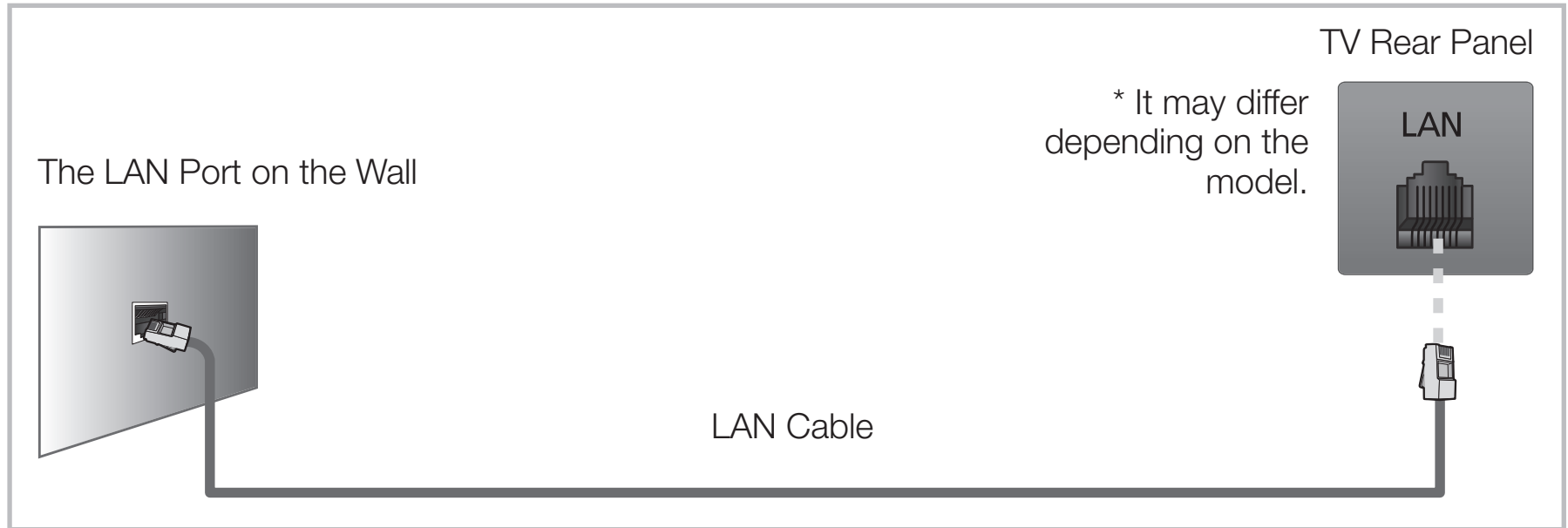

- Depending on how your network is configured, you may be able to attach your TV to your LAN by connecting the LAN port on the back of your TV directly to a network wall outlet using a LAN cable. See the diagram below. Note that the wall outlet is attached to a modem or router elsewhere in your house.



- If your network requires a Dynamic IP address, you should use an ADSL modem or router that supports Dynamic Host Configuration Protocol (DHCP).

Modems and routers that support DHCP automatically provide the IP address, subnet mask, gateway, and DNS values your TV needs to access the Internet so you do not have to enter them manually. Most home networks use a Dynamic IP address. Some networks require a Static IP address. If your network requires a Static IP address, you must enter the IP address, subnet mask, gateway, and DNS values manually on your TV's Cable Setup Screen when you set up the network connection. To get the IP address, subnet mask, gateway, and DNS values, contact your Internet Service Provider (ISP). If you have a Windows computer, you can also get these values through your computer.

-  You can use ADSL modems that support DHCP if your network requires a Static IP address. ADSL modems that support DHCP also let you use Static IP addresses.
-  It is not supported when the network speed is below or equal to 10Mbps.

■ Wireless Network Connection

To connect your TV to your network wireless, you need a wireless router or modem and a Samsung Wireless LAN Adapter (WIS12ABGNX, WIS09ABGNX), which you connect to your TV's back or side panel USB port. See the illustration below.

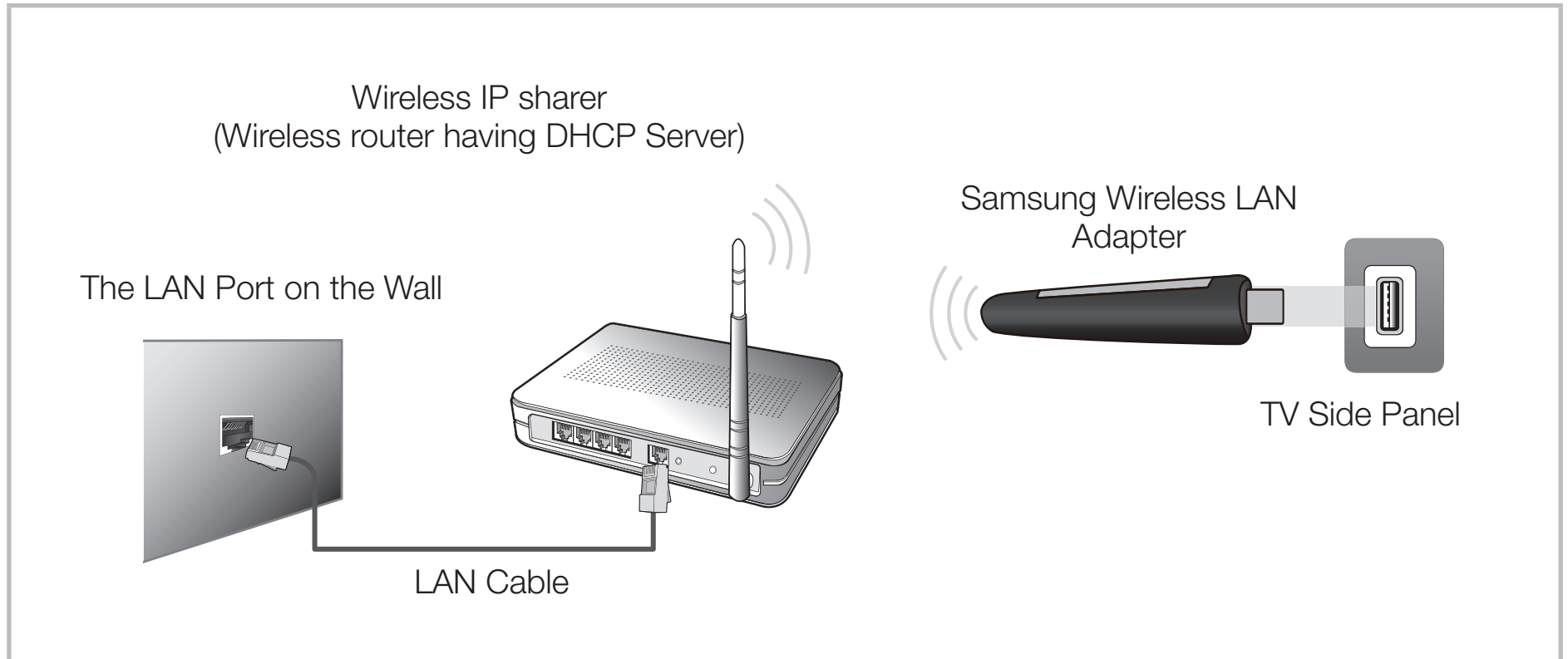

Samsung's Wireless LAN adapter is sold separately and is offered by select retailers and Ecommerce sites. Samsung's Wireless LAN adapter supports the IEEE 802.11 a/b/g and n communication protocols. Samsung recommends using IEEE 802.11n. When you play video over a network connection, the video may not be played smoothly.



NOTE

- You must use the “Samsung Wireless LAN Adapter” (WIS12ABGNX, WIS09ABGNX) to use a wireless network.
- Samsung Wireless LAN Adapter and the USB extension Cable are sold separately and are offered by select retailers and Ecommerce sites.

- To use a wireless network, your TV must be connected to a wireless IP sharer (either a router or a modem). If the wireless IP sharer supports DHCP, your TV can use a DHCP or static IP address to connect to the wireless network.
- Select a channel for the wireless IP sharer that is not currently being used. If the channel set for the wireless IP sharer is currently being used by another device nearby, this will result in interference and communication failure.
- If you apply a security system other than the systems listed below, it will not work with the TV.

- If HIGH PURE THROUGHPUT (Greenfield) 802.11n mode is selected and the Encryption type is set to WEP or TKIP for your wireless router, Samsung TVs will not support a connection in compliance with new Wi-Fi certification specifications.
- If your wireless router supports WPS (Wi-Fi Protected Setup), you can connect to the network via PBC (Push Button Configuration) or PIN (Personal Identification Number). WPS will automatically configure the SSID and WPA key in either mode.
- If your router, modem, or device is not certified, it may not connect to the TV via the “Samsung Wireless LAN Adapter”.
- Ensure the TV is turned off before you connect the Samsung Wireless LAN Adapter.

- Connection Methods: You can setup the wireless network connection like below.
 - Auto Setup (Using the Auto Network Search function)
 - Manual Setup
 - **WPS(PBC)**
 - **Wi-Fi Direct**
- The Samsung Wireless LAN Adapter may not be recognized when using a connection via a USB hub or via a USB extension cable other than the cable supplied.

Notice

The picture may appear corrupted or have static for some channels when the TV is connected to the Samsung Wireless LAN Adapter. In such a case, establish a connection using one of the following methods or connect the Samsung Wireless LAN Adapter using a USB cable in a place that is not affected by radio interference.

Method 1

Connect using the USB right angle adapter. To connect the Samsung Wireless LAN Adapter using the USB right angle adapter, follow these steps:

1. Connect the USB right angle adapter to the Samsung Wireless LAN Adapter.
2. Connect the other end of the right angle adapter to the USB port.



* The position of port may differ depending on the model.

Method 2

Connect via an extension cable

To reconnect the Samsung Wireless LAN Adapter using the extension cable, follow these steps:

1. Connect the extension cable to the USB port.
2. Connect the extension cable and Samsung Wireless LAN Adapter.
3. Attach the Samsung Wireless LAN Adapter to the back of the TV near the top, using double-sided adhesive tape.

 The Samsung Wireless LAN Adapter should be installed in an interference-free area in order to avoid interference between the adapter and tuner.

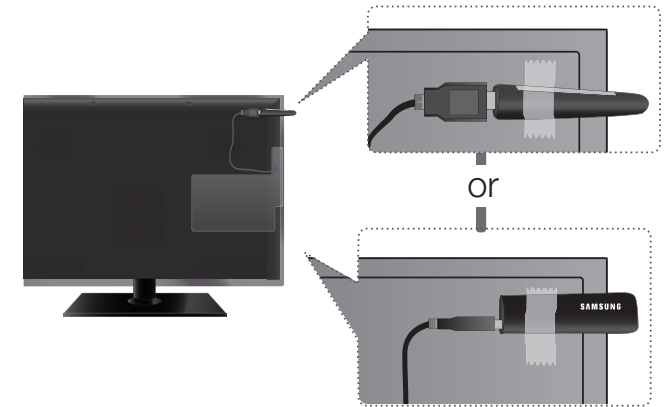

* The position of port may differ depending on the model.

■ Network Settings

 **MENU**  → **Network** → **Network Settings** → **ENTER** 

You can set the wired or wireless network connection.

 For detailed settings for wired network, refer to the "Setting the Wired Network", and for detailed settings for wireless network, refer to the "Setting the Wireless Network" in this manual.

■ Network Status

 MENU  → Network → Network Status → ENTER 

You can check the current network and Internet status.

❑ Setting the Wired Network

for LED 5 series 32" and above, PDP 490 series

📖 For LED TVs, network function is not supported depending on the country.

■ Wired Network Setup (Auto)

📖 When connecting the LAN Cable, the screen pop-up appears directly to set wired network.

Use the Automatic Network Setup when connecting your TV to a network that supports DHCP. To set up your TV's cable network connection automatically, follow these steps:

How to set up automatically

1. Go to **Network Settings** screen.
2. Select **Start**.
3. The network connection screen appears, and network setting is done.

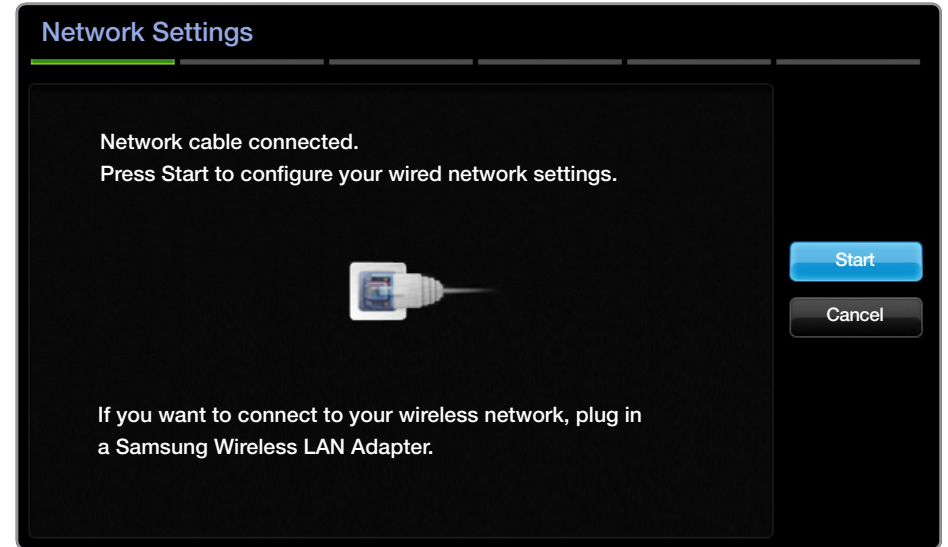

- ☞ If it fails to set automatically, check the connection of LAN port.
- ☞ If you cannot find network connection values or if you want to set connection manually, set it to Manual. Refer to following “How to set up manually”.

■ **Wired Network Setup (Manual)**

Use the Manual Network Setup when connecting your TV to a network that requires a Static IP address.

Getting the Network Connection Values

To get the Network connection values on most Windows computers, follow these steps:

1. Right click the Network icon on the bottom right of the screen.
2. In the pop-up menu that appears, click Status.
3. On the dialogue that appears, click the Support tab.
4. On the Support Tab, click the Details button. The Network connection values are displayed.

How to set up manually

To set up your TV's cable network connection manually, follow these steps:

1. Follow Steps 1 through 2 in the “How to set up automatically” procedure.
2. Select the **IP Settings** on network connection screen.
3. Set **IP Mode** to **Manual**.
4. Press the ▼ button to go to the first entry field.

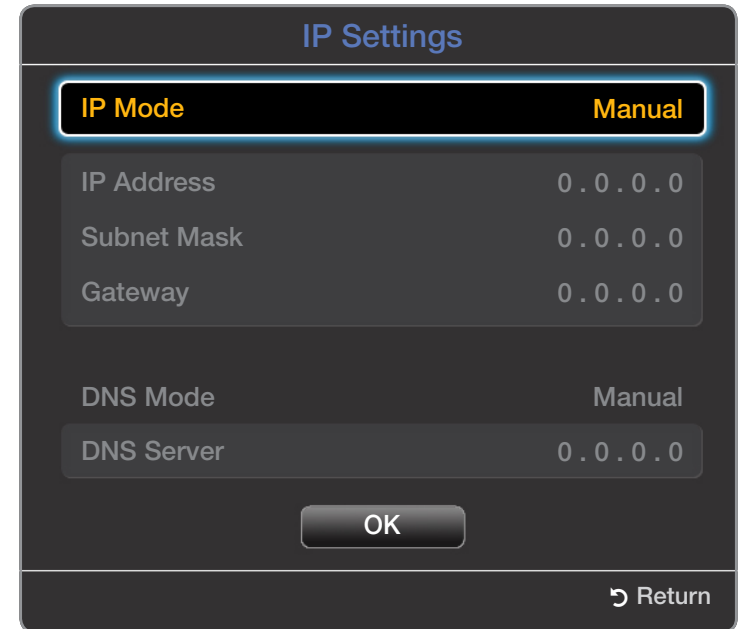

5. Enter the **IP Address**, **Subnet Mask**, **Gateway**, and **DNS Server** values. Use the number buttons to enter numbers and the arrow buttons to move from one entry field to another.
6. When done, select the **OK**.
7. The network connection screen appears, and network setting is done.

The check list for wired network connection failure

When wired network connection failed, try to apply the following information to each issue.

Issues	Solutions and Explanations
No network cable found.	<ul style="list-style-type: none">• Check that your network cable is plugged in.• If it is connected, make sure that the router is turned on; if it is on, try turning it off and on again.
IP auto setting failed.	<p>Try the following to set your IP address automatically or set your IP address manually by selecting IP Settings.</p> <ul style="list-style-type: none">• Ensure DHCP server is enabled on router and unplug and re-plug-in the router.• Contact your Internet Service Provider for more information.

Issues	Solutions and Explanations
Unable to connect to the network.	<ul style="list-style-type: none">• Check if your IP address is set correctly in IP Settings.• Contact your Internet Service Provider for more information.
Connected to your local network, but cannot connect to the Internet.	<ul style="list-style-type: none">• Check your Internet LAN cable is connected correctly to LAN port of router.• Check the DNS settings in IP Settings.• If the problem persists, contact your Internet Service Provider to access the Internet.
Network setup complete, but cannot connect to the Internet.	<ul style="list-style-type: none">• Confirm that your router is connected to the Internet.• If the problem persists, contact your Internet Service Provider to access the Internet.

❑ Setting the Wireless Network

for LED 5 series 32" and above, PDP 490 series

📖 For LED TVs, network function is not supported depending on the country.

■ Wireless Network Setup (Auto)



Most wireless networks have an optional security system that requires devices that access the network to transmit an encrypted security code called an Access or Security Key. The Security Key is based on a Pass Phrase, typically a word or a series of letters and numbers of a specified length you were asked to enter when you set up wireless security for your wireless network. If you use this method of setting up the network connection, and have a Security Key for your wireless network, you will have to enter the Pass Phrase during the setup process.





📖 When connecting Samsung Wireless LAN Adapter, the screen pop-up appears directly to set wireless network.

How to set up automatically

1. Go to **Network Settings** screen.
2. Select **Start**.
3. The Network function searches for available wireless networks. When done, it displays a list of the available networks.



4. In the list of networks, press the ▲ or ▼ button to select a network, and then press **ENTER**  button.
 -  If the wireless router is set to Hidden (Invisible), you have to select **Add Network** and enter the correct network name and Security key to establish the connection.

5. If the Security screen pop-up appears, go to step 6. If you select the wireless router which does not have wireless security, go to step 7.
6. To set wireless security for the router, enter the Security key(Security or PIN).
 -  When you enter the Security key (Security or PIN), use ▲/▼/◀/▶ buttons to select number/characters. Press **ENTER**  to enter the characters.
 -  You should be able to find the Pass Phrase on one of the set up screens you used to set up your router or modem.
7. The network connection screen appears, and network setting is done.
 -  If it fails to set Security key (Security or PIN), select **Retry** or **IP Settings**.
 -  If you want to set connection manually, select the **IP Settings**. Refer to following “How to set up manually”.

■ **Wireless Network Setup (Manual)**

Use the Manual Network Setup when connecting your TV to a network that requires a Static IP address.

Getting the Network Connection Values

To get the Network connection values on most Windows computers, follow these steps:

1. Right click the Network icon on the bottom right of the screen.
2. In the pop-up menu that appears, click Status.
3. On the dialogue that appears, click the Support tab.
4. On the Support Tab, click the Details button. The Network connection values are displayed.

How to set up manually

To set up your TV's cable network connection manually, follow these steps:

1. Follow Steps 1 through 7 in the “How to set up automatically” procedure.
2. Select the **IP Settings** on network connection screen.
3. Set **IP Mode** to **Manual**.
4. Press the ▼ button to go to the first entry field.
5. Enter the **IP Address**, **Subnet Mask**, **Gateway**, and **DNS Server** values. Use the number buttons to enter numbers and the arrow buttons to move from one entry field to another.
6. When done, select the **OK**.
7. The network connection screen appears, and network setting is done.

■ **Wireless Network Setup (WPS(PBC))**

If your router has a WPS(PBC) button, follow these steps:

1. Go to **Network Settings** screen.
2. Select **Start**.
3. The Network function searches for available wireless networks. When done, it displays a list of the available networks.
4. Select the **WPS(PBC)**.
5. Press the WPS(PBC) button on your router within 2 minutes. Your TV automatically acquires all the network setting values it needs and connects to your network.
6. The network connection screen appears, and network setting is done.

The check list for wireless network connection failure

When wireless network connection failed, try to apply the following information to each issue.

Issues	Solutions and Explanations
Wireless network connection failed.	<ul style="list-style-type: none">• No wireless router selected. Go to Network Settings to select your router.• Samsung Wireless LAN adapter is required to use a wireless network.• Make sure the TV is connected to a wireless IP sharer (Router).
IP auto setting failed.	<ul style="list-style-type: none">• Try the following to set your IP address automatically or set your IP address manually by selecting IP Settings.• Ensure DHCP server is enabled on router and unplug and re-plug-in the router.• Check if you need to enter a security key to use the router.• Contact your Internet Service Provider for more information.

Issues	Solutions and Explanations
Unable to connect to wireless router.	<ul style="list-style-type: none"> • Check that the router is turned on, and if it is on, try turning it off and on again. • Check if you need to enter a security key to use the router.
Unable to connect to the network.	<ul style="list-style-type: none"> • Check if your IP address is set correctly in IP Settings. • Check if you need to enter a security key to use the router. • Contact your Internet Service Provider for more information.
Connected to your local network, but cannot connect to the Internet.	<ul style="list-style-type: none"> • Check your Internet LAN cable is connected correctly to LAN port of router. • Check the DNS settings in IP Settings. • If the problem persists, contact your Internet Service Provider to access the Internet.
Network setup complete, but cannot connect to the Internet.	<ul style="list-style-type: none"> • Confirm that your router is connected to the Internet. • If the problem persists, contact your Internet Service Provider to access the Internet.

If Your TV Fails to Connect to the Internet

Your TV may not be able to connect to the Internet because your ISP has permanently registered the MAC address (a unique identifying number) of your PC or modem, which it then authenticates each time you connect to the Internet as a way of preventing unauthorized access. As your TV has a different MAC address, your ISP can not authenticate its MAC address, and your TV can not connect.

To resolve this problem, ask your ISP about the procedures required to connect devices other than a PC (such as your TV) to the Internet.

If your Internet service provider requires an ID or password to connect to the Internet, your TV may not be able to connect to the Internet. If this is the case, you must enter your ID or password when connecting to the Internet.

The internet connection may fail because of a firewall problem. If this is the case, contact your Internet service provider.

If you cannot connect to the Internet even after you have followed the procedures of your Internet service provider, please contact Samsung Electronics.

❑ Managing the Network Connected Devices

for PDP 490 series

■ Wi-Fi Direct

 **MENU**  → **Network** → **Wi-Fi Direct** → **ENTER** 



Set to connect the TV to wireless mobile devices. Using this function, you can connect wireless mobile devices with your TV directly without a wireless router.

 You can use this function when connecting the Samsung Wireless LAN Adapter.

 It only supports **AllShare Play** function.

 It may not be supported depending on the mobile device.

How to connect the device to your TV using Wi-Fi Direct function

1. Go to **Wi-Fi Direct** screen. The TV starts to search devices.
 2. Turn on the Wi-Fi Direct function on your device. Select the desired device, and then press the **ENTER**  button.
 - **PBC**: Press the WPS(PBC) button on your device within 2 minutes. Your TV automatically acquires all the network setting values it needs and connects to your network.
 - **PIN**: Input the displayed PIN on your device.
-  If you want to disconnect the device, select the connected device, and press the **ENTER**  button to select **Disconnect**.

■ AllShare Settings

 **MENU**  → **Network** → **AllShare Settings** → **ENTER** 

Set whether to allow a network connected device like a smartphone or tablet to share content or control TV using an application downloaded on your mobile device. For details on set up options, refer to the "Using the DLNA Functions".

■ Device Name

 **MENU**  → **Network** → **Device Name** → **ENTER** 

Change the TV's name by keying in a name manually.

 A keyboard appears on the screen and you can key in a name for your TV manually using your remote control. For example, if you want to change the name to Samsung TV, press each character using the ▲/▼/◀/▶ buttons, and then select **Done**.

❑ Executing initial setup

■ Setup

 **MENU**  → **System** → **Setup** → **ENTER** 

Configure the channels and the time when setting up the TV for the first time or when resetting the unit.

 For the detailed information about setting **Setup**, refer to “Initial Setup” in User Manual.

□ Setting the Time

■ Time

 **MENU**  → **System** → **Time** → **ENTER** 

The current time will appear every time you press the **INFO** button.

- **Clock**: Setting the clock is for using various timer features of the TV.

 If you disconnect the power cord, you have to set the clock again.

Clock Mode: Set up the current time manually or automatically.

- **Auto**: Set the current time automatically using the time from a digital channel.

 The aerial must be connected in order to set the time automatically.

– **Manual**: Set the current time manually.

 Depending on the broadcast station and signal, the auto time set up may not be correct. In this case, set the time manually.

Clock Set: Set the **Date** and **Time**.

 Available only when **Clock Mode** is set to **Manual**.

 You can set the **Date** and **Time** directly by pressing the number buttons on the remote control.

Time Zone (depending on the country): Select your time zone.

 This function is only available when the **Clock Mode** is set to **Auto**.

 When selecting **Manual** in **Time Zone**, **GMT** and **DST** will be activated.

❏ Using the Sleep Timer

 MENU  → **System** → **Time** → **Sleep Timer** → ENTER 

- **Sleep Timer** : Automatically shuts off the TV after a preset period of time. (30, 60, 90, 120, 150 and 180 minutes).

 To cancel **Sleep Timer**, select **Off**.

❑ Setting the On / Off Timer

 MENU  → System → Time → On Timer <or> Off Timer → ENTER 

- **On Timer 1 / On Timer 2 / On Timer 3:** Three different on timer settings can be made. You must set the clock first.
 - **Setup:** Select **Off, Once, Everyday, Mon~Fri, Mon~Sat, Sat~Sun** or **Manual** to set at your convenience. If you select **Manual**, you can set up the day you want to activate the timer.
 -  The ✓ mark indicates the day you've selected.
 - **Time:** Set the hour and minute.
 - **Volume:** Set the desired volume level.

- **Source**: Select **TV** or **USB** content to be played when the TV is turned on automatically. (**USB** can be selected only when a USB device is connected to the TV)
- **Aerial** (when the **Source** is set to **TV**): Select **ATV** or **DTV**.
- **Channel** (when the **Source** is set to **TV**): Select the desired channel.
- **Music / Photo** (when the **Source** is set to **USB**): Select a folder in the USB device containing music or photo files to be played when the TV is turned on automatically.

 NOTE

- If there is no music file on the USB device or the folder containing a music file is not selected, the timer function does not operate correctly.

- When there is only one photo file in the USB device, the slide show will not play.
- If a folder name is too long, the folder cannot be selected.
- Each USB you use is assigned its own folder. When using more than one of the same type of USB, make sure the folders assigned to each USB have different names.
- It is recommended that you use a USB memory stick and a multi card reader when using **On Timer**.
- The **On Timer** function may not work with USB devices with a built-in battery, MP3 players, or PMPs made by some manufacturers because these devices take a long time to be recognized.

- **Off Timer 1 / Off Timer 2 / Off Timer 3:** Three different off timer settings can be made. You must set the clock first.

Setup: Select **Off, Once, Everyday, Mon~Fri, Mon~Sat, Sat~Sun** or **Manual** to set at your convenience. If you select **Manual**, you can set up the day you want to activate the timer.

 The ✓ mark indicates the day you've selected.

Time: Set the hour and minute.

❏ Locking Programme

■ Security



 MENU  → System → Security → ENTER 

 The PIN input screen appears before the setup screen.

 Enter your 4-digit PIN. Change the PIN using the **Change PIN** option.

- **Channel Lock (Off / On):** Lock channels in Channel menu to prevent unauthorized users, such as children, from watching unsuitable programme.

 Available only when the **Source** is set to **TV**.

- **Programme Rating Lock** (depending on the country): Prevent unauthorized users, such as children, from watching unsuitable programme with a user-defined 4-digit PIN code. If the selected channel is locked, the “” symbol will be displayed.
-  The items of **Programme Rating Lock** differs depending on the country.
- **Change PIN**: Change your password required to set up the TV.

❑ Picture In Picture (PIP)

■ PIP

 MENU  → System → PIP → ENTER 

You can watch the TV tuner and one external video source simultaneously. **PIP** (Picture-in-Picture) does not function in the same mode.







NOTE

- For PIP sound, refer to the **Sound Select** instructions.
- If you turn the TV off while watching in **PIP** mode, the PIP window will disappear.
- You may notice that the picture in the PIP window becomes slightly unnatural when you use the main screen to view a game or karaoke.

- PIP settings

LCD 420 does not support AV, Component mode

Main picture	Sub picture
Component, HDMI	TV

- **PIP (Off / On)**: Activate or deactivate the PIP function.
- **Channel**: Select the channel for the sub-screen.
- **Size** ( / ): Select a size for the sub-picture.
- **Position** ( /  /  / ): Select a position for the sub-picture.
- **Sound Select (Main / Sub)**: You can choose the desired sound (**Main / Sub**) in **PIP** mode.

□ Economical Solutions

■ Eco Solution

☞ MENU☐☐☐ → System → Eco Solution → ENTER ☞

- **Energy Saving (Off / Low / Medium / High / Picture Off)** **TOOLS☞**: This adjusts the brightness of the TV in order to reduce power consumption. If you select **Picture Off**, the screen is turned off, but the sound remains on. Press any button except volume button to turn on the screen.

- **Eco Sensor (Off / On)** for LED 5 series 32" and above, PDP TV: To enhance your power savings; the picture settings will automatically adapt to the light in the room.

 If you adjust the **Backlight** for LED, LCD TV / **Cell Light** for PDP TV, the **Eco Sensor** will be set to **Off**.



Min. Backlight for LED, LCD TV / **Min Cell Light** for PDP TV: When **Eco Sensor** is **On**, the minimum screen brightness can be adjusted manually.



 If **Eco Sensor** is **On**, the display brightness may change (become slightly darker or brighter) depending on the surrounding light intensity.

- **No Signal Power Off (Off / 15 min / 30 min / 60 min):** To avoid unnecessary energy consumption, set how long you want the TV to remain on if it's not receiving a signal.
 Disabled when the PC is in power saving mode.
- **Auto Power Off (Off / On):** The TV will be automatically turned off when no user operation is received for 4 hours.



❑ Other Features

■ Language



 MENU  → System → Language → ENTER 

- **Menu Language:** Set the menu language.
- **Teletext Language** (depending on the country): Set a desired language for teletext.
 -  English is the default in cases where the selected language is unavailable in the broadcast.
- **Preferred Language (Primary Audio / Secondary Audio / Primary Subtitle / Secondary Subtitle / Primary Teletext / Secondary Teletext):** Select a language, which will be the default language when a channel is selected.
 -  **Primary Teletext** and **Secondary Teletext** may not be supported in some locations.

■ Subtitle



 MENU  → **System** → **Subtitle** → ENTER 

Use this menu to set the **Subtitle** mode.

- **Subtitle (Off / On)**: Switches subtitles on or off.
- **Subtitle Mode (Normal / Hearing Impaired)**: Sets the subtitle mode.
- **Subtitle Language**: Sets the subtitle language.
 -  If the programme you are watching does not support the **Hearing Impaired** function, **Normal** automatically activates even if the **Hearing Impaired** mode is selected.
 -  English is the default in cases where the selected language is unavailable in the broadcast.

■ Digital Text (Disable / Enable)

(UK only)

 **MENU**  → **System** → **Digital Text** → **ENTER** 

If the programme broadcasts with digital text, this feature is enabled.

MHEG (Multimedia and Hypermedia Information Coding Experts Group)

An International standard for data encoding systems used in multimedia and hypermedia. This is at a higher level than the MPEG system which includes data-linking hypermedia such as still images, character service, animation, graphic and video files as well as multimedia data. MHEG is user runtime interaction technology and is being applied to various fields including VOD (Video-On-Demand), ITV (Interactive TV), EC (Electronic Commerce), teleeducation, tele-conferencing, digital libraries and network games.

■ Auto Protection Time for LCD, LED TV

 MENU  → System → Auto Protection Time → ENTER 

- **Auto Protection Time (Off / 2 hours / 4 hours / 8 hours / 10 hours):** If the screen remains idle with a still image for a certain period of time defined by the user, the screen saver is activated to prevent the formation of ghost images on the screen.

Screen Burn Protection for PDP TV

 **MENU**  → **System** → **Screen Burn Protection** → **ENTER** 

To reduce the possibility of screen burn, this unit is equipped with screen burn prevention technology. The Time setting allows you to programme the time between movement of the picture in minutes.

- **Pixel Shift (Off / On)**: Using this function, you can minutely move pixels on the PDP in horizontal or vertical direction to minimize after image on the screen.

 Optimum condition for pixel shift

	Item	TV / HDMI
Horizontal	0~4	4
Vertical	0~4	4
Time (minute)	1~4 min	4 min

 The **Pixel Shift** value may differ depending on the monitor size (inches) and mode.

 This function is not available in the **Screen Fit** mode.



- **Auto Protection Time (Off / 10 min / 20 min / 40 min / 1 hour)**: If the screen remains idle with a still image for a certain period of time defined by the user, the screen saver is activated to prevent the formation of ghost images on the screen.
- **Scrolling**: This function removes after-images on the screen by moving all the pixels on the PDP according to a pattern. Use this function when there are remaining after images or symbols on the screen, especially when you displayed a still image on the screen for a long time.

 The after-image removal function has to be executed for a long time (approximately 1 hour) to effectively remove after-images on the screen. If the after-image is not removed after performing the function, repeat the function again.

 Press any key on the remote control to cancel this feature.

- **Side Grey (Light / Dark):** When you watch TV with the screen ratio set to 4:3, the screen is prevented from any damage by adjusting the white balance on both extreme left and right sides.

■ General

 MENU  → System → General → ENTER 

- **Game Mode (Off / On):** When connecting to a game console such as PlayStation™ or Xbox™, you can enjoy a more realistic gaming experience by selecting game mode.

NOTE

- Precautions and limitations for game mode
 - To disconnect the game console and connect another external device, set **Game Mode** to **Off** in the setup menu.
 - If you display the TV menu in **Game Mode**, the screen shakes slightly.

- **Game Mode** is not available in **TV** mode.
- After connecting the game console, set **Game Mode** to **On**. Unfortunately, you may notice reduced picture quality.
- If **Game Mode** is **On**:
 - **Picture Mode** is set to **Standard** and **Sound Mode** is set to **Movie**.
- **Panel Lock (Off / On)**: Lock or unlock all the keys on the panel.
- **Boot Logo (Off / On)**: Display Samsung logo when the TV is turned on.

■ DivX® Video On Demand

 **MENU**  **System**  **DivX® Video On Demand**  **ENTER** 

Shows the registration code authorized for the TV. If you connect to the DivX web site and register with 10-digit registration code, you can download the VOD activation file.

Once you play it using **Videos**, the registration is completed.

 For more information on DivX® VOD, visit <http://vod.divx.com>.



■ Common Interface

 MENU  → System → Common Interface → ENTER 

- **CI Menu:** This enables the user to select from the CAM-provided menu. Select the CI Menu based on the menu PC Card.
- **Application Info:** View information on the CAM inserted into the CI slot and on the “CI or CI+ CARD” which is inserted into the CAM. You can install the CAM anytime whether the TV is on or off.
 1. Purchase a CI CAM module at your nearest dealer or by phone.
 2. Firmly insert the “CI or CI+ CARD” into the CAM in the direction of the arrow.
 3. Insert the CAM with the “CI or CI+ CARD” into the common interface slot, in the direction of the arrow so that it aligns parallel with the slot.
 4. Check if you can see a picture on a scrambled signal channel.

□ Support Menu

■ e-Manual

 **MENU**  → **Support** → **e-Manual** → **ENTER** 

You can read the introduction and instructions about the TV features stored in your TV.

 For the detailed information about e-Manual Screen, refer to “How to use the e-Manual” in User Manual.

■ Self Diagnosis

 **MENU**  → **Support** → **Self Diagnosis** → **ENTER** 

 **Self Diagnosis** might take few seconds, this is part of the normal operation of the TV.

- **Picture Test (Yes / No)**: Use to check for picture problems.
- **Sound Test (Yes / No)**: Use the built-in melody sound to check for sound problems.

 If you hear no sound from the TV's speakers, before performing the sound test, make sure **Speaker Select** is set to **TV Speaker** in the **Sound** menu. **for LED, PDP TV**

 The melody will be heard during the test even if **Speaker Select** is set to **External Speaker** or the sound is muted by pressing the **MUTE** button. **for LED, PDP TV**

- **Signal Information:** (digital channels only) HDTV channel's reception quality is either perfect or the channels are unavailable. Adjust your aerial to increase signal strength.
- **Reset:** Reset all settings to the factory defaults except network settings.
 - ☞ The PIN input screen appears before the setup screen.
 - ☞ Enter your 4-digit PIN. Change the PIN using the **Change PIN** option.
- **Troubleshooting:** If the TV seems to have a problem, refer to this description.
 - ☞ If none of these troubleshooting tips apply, contact the Samsung customer service centre.

■ Software Upgrade

 MENU  → Support → Software Upgrade → ENTER 

Software Upgrade can be performed by downloading the latest firmware from “www.samsung.com” to a USB memory device.

Current Version-the software already installed in the TV.

Installing the Latest Version

- **By USB:** Insert a USB drive containing the firmware upgrade file, downloaded from “www.samsung.com” into the TV. Please be careful not to disconnect the power or remove the USB drive until upgrades are complete. The TV will be turned off and on automatically after completing the firmware upgrade. When software is upgraded, video and audio settings you have made will return to their default settings. We advise you to write down your settings so that you can easily reset them after the upgrade.

- **By Online** **for PDP 490 series**: Upgrade the software using the Internet.
 - ☞ First, configure your network. For detailed procedures on using the Network Setup, refer to the “**Network Settings**” instructions.
 - ☞ If the internet connection doesn’t operate properly, the connection may be broken. Please retry downloading. If the problem persists, download by USB and upgrade.

- **By Channel:** Upgrade the software using the broadcasting signal.
 - ☞ If the function is selected during the software transmission period, software will be automatically searched and downloaded.
 - ☞ The time required to download the software is determined by the signal status.
- **Alternative Software:** Replace the current software with the alternative.
- **Standby Mode Upgrade (Off / 1 hour later / 2 hours later / 00:00 / 02:00 / 12:00 / 14:00):** A manual upgrade will be automatically performed at selected time. Since the power of the unit is turned on internally, the screen may be turned on slightly for the product. This phenomenon may continue for more than 1 hour until the software upgrade is complete.

■ Contact Samsung

 **MENU**  → **Support** → **Contact Samsung** → **ENTER** 

View this information when your TV does not work properly or when you want to upgrade the software. You can find information regarding our call centres, and how to download products and software.

■ Contents Home

 MENU  → Support → Contents Home → ENTER 

You can enjoy useful and various contents.



Using the 3D function

for PDP 490 series

3D

 MENU  → Picture → 3D → ENTER 

This exciting new feature enables you to view 3D content. To fully enjoy this feature, you must purchase a pair of Samsung 3D Active Glasses to view 3D video. Samsung 3D Active Glasses are sold separately. For more detailed purchasing information, contact the retailer where you purchased this TV.

 "Full HD 3D Glasses™" Logo indicates compatibility between display products and 3D Glasses which are compliant with the "Full HD 3D Glasses™" format, and does not indicate picture quality of display products.

Viewing TV using the 3D function

IMPORTANT HEALTH AND SAFETY INFORMATION FOR 3D PICTURES.





Read and understand the following safety information before using the TV's **3D** function.

WARNING

- Some viewers may experience discomfort while viewing 3D TV such as dizziness, nausea and headaches. If you experience any such symptom, stop viewing 3D TV, remove 3D Active Glasses and rest.
- Watching 3D images for an extended period of time may cause eye strain. If you feel eye strain, stop viewing 3D TV, remove your 3D Active Glasses and rest.

- A responsible adult should frequently check on children who are using the 3D function. If there are any reports of tired eyes, headaches, dizziness, or nausea, have the child stop viewing 3D TV and rest.
- Do not use the 3D Active Glasses for other purposes (such as general eyeglasses, sunglasses, protective goggles, etc.)
- Do not use the 3D function or 3D Active Glasses while walking or moving around. Using the 3D function or 3D Active Glasses while moving around may result in injuries due to running into objects, tripping, and/or falling.

- **3D Mode:** Select the 3D input format.
 - ☞ If you want to feel the 3D effect fully, please wear the 3D Active Glasses first, and then select 3D Mode from the list below that provides the best 3D viewing experience.
 - ☞ When watching 3D images, turn on 3D Active Glasses.

3D Mode		Operation
 Off	Off	Turns the 3D function off.
 2D → 3D	2D → 3D	Changes a 2D image to 3D.
	Side by Side	Displays two images next to each other.
	Top & Bottom	Displays one image above another.



Some file format may not be supported the "2D → 3D".



When you watch 3D images under flickering lighting such as a fluorescent lamp (50Hz ~ 60Hz) or a 3 wavelength lamp, you may notice some screen flickering. If this occurs, dim or turn off the light.

- **3D Perspective (-5 ~ +5)**: Adjust overall 3D perspective of on-screen image.
- **Depth (1~10)**: Adjust overall depth.
- **L/R Change (L/R Image / R/L Image)**: Swap the left and right pictures.



Support resolution (16:9 only)

- HDMI

Source	Resolution	Frequency (Hz)
	1280 x 720p	50 / 59.94 / 60 Hz
	1920 x 1080i	50 / 59.94 / 60 Hz
	1920 x 1080p	23.98 / 24 / 25 / 29.97 / 30 / 50 / 59.94 / 60 Hz
Frame Packing	1280 x 720p	50 / 59.94 / 60 Hz
	1920 x 1080i	50 / 59.94 / 60 Hz
	1920 x 1080p	23.98 / 24 / 25 / 29.97 / 30 Hz

- Components & DTV

Source	Resolution	Frequency (Hz)
Components	1280 x 720p	50 / 59.94 / 60 Hz
	1920 x 1080i	50 / 59.94 / 60 Hz
	1920 x 1080p	23.98 / 24 / 25 / 29.97 / 30 / 50 / 59.94 / 60 Hz
DTV	1280 x 720p	50 / 59.94 / 60 Hz
	1920 x 1080i	50 / 59.94 / 60 Hz
	1920 x 1080p	25 Hz

- Videos / Photos (In **AllShare Play**)

Refer to "Supported Subtitle and AllShare Play file formats" in the Other Information section.

How to watch the 3D image



- Method 1







Some 3D modes may not be available depending on the format of the image source.



To watch in 3D, wear 3D Active Glasses and press the power button on the glasses.

1. Press the **MENU** button, use the ▲ or ▼ button to select **Picture**, and then press the **ENTER**  button.
2. Use the ▲ or ▼ button to select **3D**, and then press the **ENTER**  button.

3. Use the ▲ or ▼ button to select **3D Mode**, and then press the **ENTER**  button.
 4. Using the ◀ or ▶ buttons, select the **3D Mode** of the image you want to view.
- Method 2
 1. Press the  button. And then you can view the **3D** image.
 2. If you want to change 3D options (such as **3D Perspective**), press the **MENU** button, and then select **Picture**.
 3. Go to Step 3 in the “Method 1”, and follow the directions from that point on.
 -  To exit the **3D** mode, press the  button again.

Before using 3D function...



NOTE

- **3D Mode** is set to **Off** automatically when you access **AllShare Play** or **e-Manual** functions.
- **3D Mode** is set to memorised configuration value automatically, when changing the input source.
- Some **Picture** functions are disabled in **3D** mode.
- **PIP** is not supported in **3D** mode.
- 3D Active Glasses from Samsung's previous product (IR type) or other manufacturers not be supported.
- When the TV is initially powered on, may take some time until the 3D display is optimized.

- The 3D Active Glasses may not work properly if there is any other 3D product or electronic devices turned on near the glasses or TV. If there is a problem, keep other electronic devices as far away as possible from the 3D Active Glasses.
- Be sure to stay within the viewing angle and optimum TV viewing distance when watching 3D pictures.
- Otherwise, you may not be able to enjoy proper 3D effects.
- The ideal viewing distance should be three times or more the height of the screen. We recommend sitting with viewer's eyes on a level with the screen.

❑ Using the Media Contents

Enjoy photos, music and movie files saved on a USB Mass Storage Class (MSC) device.

1. Press the **CONTENT** button to select **Media Play / AllShare Play** Only for PDP 490 series.
2. Press **▲/▼** button to select desired menu (**Videos, Photos, Music**), then press the **ENTER**  button.
3. Press **▲/▼** button to select desired device, then press the **ENTER**  button again.

❑ Connecting a USB Device

1. Turn on your TV.
2. Connect a USB device containing photo, music and movie files to the USB port on the side of the TV.
3. When USB is connected to the TV, popup window appears. You can select the **Videos**, **Photos** or **Music** directly.

 It might not work properly with unlicensed multimedia files.

 Need-to-Know List before using Media Contents

- MTP (Media Transfer Protocol) is not supported.
- The file system supports FAT16, FAT32 and NTFS.
- Certain types of USB Digital camera and audio devices may not be compatible with this TV.



- Media Contents only supports USB Mass Storage Class (MSC) devices. MSC is a Mass Storage Class Bulk-Only Transport device. Examples of MSC are Thumb drives, Flash Card Readers (USB HUB are not supported). Devices should be connected directly to the TV's USB port.
- Before connecting your device to the TV, please back up your files to prevent them from damage or loss of data. SAMSUNG is not responsible for any data file damage or data loss.
- The HDD (Hard Disk Drive) connected to USB is not supported.
- Do not disconnect the USB device while it is loading.
- The higher the resolution of the image, the longer it takes to display on the screen.
- The maximum supported JPEG resolution is 15360 x 8640 pixels.

- For unsupported or corrupted files, the “Not Supported File Format” message is displayed.
- MP3 files with DRM that have been downloaded from a non-free site cannot be played. Digital Rights Management (DRM) is a technology that supports the creation, distribution and management of the content in an integrated and comprehensive way, including the protection of the rights and interests of the content providers, the prevention of the illegal copying of contents, as well as managing billings and settlements.
- A USB device that requires high power (more than 500mA or 5V) may not be supported.
- If the TV has been no input during time set in **Auto Protection Time**, the Screensaver will run.
- The power-saving mode of some external hard disk drives may be released automatically when connected to the TV.

- If a USB extension cable is used, the USB device may not be recognized or the files on the device may not be read.
- If a USB device connected to the TV is not recognized, the list of files on the device is corrupted or a file in the list is not played, connect the USB device to the PC, format the device and check the connection.
- If a file deleted from the PC is still found when Media Contents is run, use the “Empty the Recycle Bin” function on the PC to permanently delete the file.
- Media Contents only supports sequential jpeg format.
- The scene search and thumbnail functions are not supported in the **Videos**.
- If the number of files and folders saved on a USB storage device is approximately over 4000, the files and folders may not appear and some folders may not be opened.

Disconnecting a USB Device

- Method 1: Using the **SOURCE** button.
 1. Press the **SOURCE** button.
 2. Select a desired USB device, and then press the **TOOLS** button. The **Tools** menu appears.
 3. Select **Safely Remove USB Device**, and then wait until the selected USB device is disconnected. You can remove a USB device from the TV.

- Method 2: Using the **Media Play / AllShare Play** Only for PDP 490 series home screen.
 1. Go to **Media Play / AllShare Play** Only for PDP 490 series home screen.
 2. Select any category, and then press the **ENTER**  button.
 3. Select a desired USB device, and then press the **TOOLS** button. The **Tools** menu appears.
 4. Select **Safely Remove USB Device**, and then wait until the selected USB device is disconnected. You can remove a USB device from the TV.
-  To remove a USB device from the TV, we recommend use **Safely Remove USB Device** function.

❑ Connecting to the PC through network

for PDP 490 series

You can play pictures, music and videos saved on your PC through a network connection in the **AllShare Play** mode over your TV.



 If you want to use **AllShare Play** to play files saved on your PC over your TV, you should download “AllShare PC Software” and users manual from “www.samsung.com”.

1. For more information on how to configure your network, refer to ‘Network Connection’.

- You are recommended to locate both TV and PC in same subnet. The first 3 parts of the IP address of the TV and PC should be the same and only the last part (the host address) should be changed. (e.g. IP Address: 123.456.789.**)



2. Using a LAN cable, connect between the external modem and the PC onto which the AllShare PC Software programme will be installed.
 - You can connect the TV to the PC directly without connecting it through a Sharer (Router).

 Functions that are not supported when connecting to a PC through a network:

- The **Background Music On** and **Background Music Setting** functions.
- The  (REW) or  (FF) button while a movie is playing.

 The DivX DRM, Multi-audio, embedded caption does not supported.

 AllShare PC Software should be permitted by the firewall programme on your PC.

- ✎ When you use **AllShare Play** mode through a network connection, according to functions of the provided server:
 - The sorting method may vary.
 - The  (REW),  (FF) or  (Pause) buttons may not work depending on the content information.
- ✎ If you experience any file stuttering issue while playing a video over a wireless network, we recommend using a wired network.

❑ Screen Display

Move to the desired file using the ◀/▶/▲/▼ buttons and then press the **ENTER** ◀ or ▶ (Play) button. The screen may differ depending on the way to enter the screen.

* The displayed image may differ depending on the model.

Information:

You can ascertain the selected device name, contents mode, folder/file name, page.

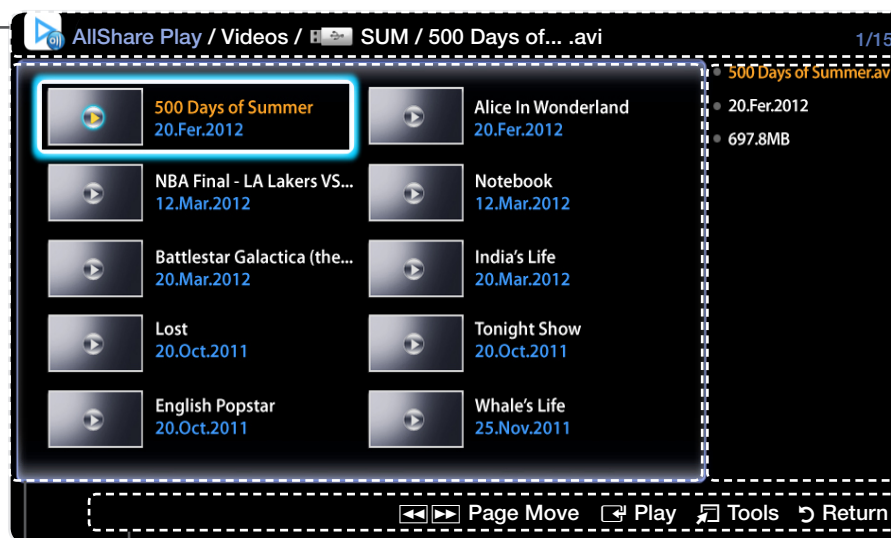

Information:

You can ascertain the name, size and created date of the selected file.

File List Section:





You can confirm the files and groups that are sorted by category.

Operation Buttons:

- ▶ **Play**: Plays the selected file.
- ⚙️ **Tools**: Displays the option menu.
- ↶ **Return**: Move to the previous step.
- ◀▶/B C **Page Move**: Move to up or down page.

■ Videos

Playing Video

1. Press the ◀/▶/▲/▼ button to select the desired video in the file list.
 2. Press the **ENTER**  button or  (Play) button.
 - The selected file name is displayed on the top with its playing time.
 - If video time information is unknown, play time and progress bar are not displayed.
 - During video playback, you can search using ◀ and ▶ button.
 - You can use () (REW) and () (FF) buttons during playback.
-  In this mode, you can enjoy movie clips contained on a Game, but you cannot play the Game itself.

- Supported Subtitle Formats

- External

Name	File extension
MPEG-4 timed text	.ttxt
SAMI	.smi
SubRip	.srt
SubViewer	.sub
Micro DVD	.sub or .txt
SubStation Alpha	.ssa
Advanced SubStation Alpha	.ass
Powerdivx	.psb

- Internal

Name	Container	Format
Xsub	AVI	Picture Format
SubStation Alpha	MKV	Text Format
Advanced SubStation Alpha	MKV	Text Format
SubRip	MKV	Text Format
MPEG-4 Timed text	MP4	Text Format

- Supported Video Formats

File Extension	Container	Video Codec	Resolution	Frame rate (fps)	Bit rate (Mbps)	Audio Codec
*.avi	AVI MKV ASF MP4 3GP VRO VOB PS TS	DivX 3.11/4.x/5.x/6.1	1920 x 1080	6~30	30	AC3 LPCM ADMPCM (IMA, MS) AAC HE-AAC WMA DD+ MPEG (MP3) DTS Core
*.mkv		MPEG4 SP/ASP				
*.asf		H.264 BP/MP/HP				
*.wmv			640 x 480		8	
*.mp4						
*.3gp			1920 x 1080		30	
*.vro						
*.mpg						
*.mpeg						
*.ts						
*.tp						
*.trp						
*.m2ts						
*.mts						
*.divx		MPEG1				

Other Restrictions









- Video content will not play, or not play correctly, if there is an error in the content or the container.
- Sound or video may not work if the contents have a standard bit rate/frame rate above the compatible Frame/sec listed in the table.
- If the Index Table is in error, the Seek (Jump) function is not supported.
- When playing the video through network, it may not work depending on the network status. When you play video over a network connection, the video may not be played smoothly. **for PDP 490 series**
- Some USB/digital camera devices may not be compatible with the player.
- The menu can be displayed late if the video is over 10Mbps(bit rate).

Video decoder	Audio decoder
<ul style="list-style-type: none">● Supports up to H.264, Level 4.1● H.264 FMO / ASO / RS, VC1 SP / MP / AP L4 and AVCHD are not supported.● GMC is not supported.	<ul style="list-style-type: none">● WMA supports up to 10 Pro 5.1 channel and M2 profile. (LBR mode of M0 is not supported)● WMA lossless audio is not supported.



■ Photos

Viewing a Photo (or Slide Show)







1. Press the ◀/▶/▲/▼ button to select the desired photo in the file list.
2. Press the **ENTER**  button.
 -  During the slide show, all files in the file list will be displayed in order.
 -  When you press the  (Play) button in the file list, slide show will be started immediately.
 -  During the slide show, you can adjust the slide show speed using  (REW) or  (FF) button.
 -  You can move to other file using ◀ or ▶ button.
-  Music files can be automatically played during the slide show if the **Background Music On** is set.

- Supported Photo Formats

File Extension	Type	Resolution
*.jpg	JPEG	15360 X 8640
*.bmp	BMP	1920 X 1080
*.mpo	MPO	15360 X 8640

■ Music

Playing Music

1. Press the ◀/▶/▲/▼ button to select the desired Music in the file list.
 2. Press the **ENTER**  button or  (Play) button.
 - You can use  (REW) and  (FF) buttons during playback.
-  Only displays the files with supported music file extension. Other file extensions are not displayed, even if they are saved on the same USB device.
-  If the sound is abnormal when playing music files, adjust the **Equaliser** in the **Sound** menu. (An over-modulated music file may cause a sound problem.)

Using the playback menu



- Press the ◀/▶ button to select the desired menu.
 - **Play / Pause:** You can start or stop a music. Alternatively, the ▶ or || button on the remote.
 - **Repeat Mode (Off / One Song / All):** You can play music files repeatedly.
 - **Shuffle Mode (Off / On):** You can play the music randomly.
 - **Sound Mode (Standard / Music / Movie / Clear Voice / Amplify):** You can adjust the sound setting.

- Supported Music Formats

File Extension	Type	Codec	Remark
*.mp3	MPEG	MPEG1 Audio Layer 3	
*.m4a *.mpa *.aac *.3ga	MPEG4	AAC	
*.flac	FLAC	FLAC	<ul style="list-style-type: none">Seek is not supported. Supports up to 2ch.
*.ogg	OGG	Vorbis	<ul style="list-style-type: none">Supports up to 2ch.
*.wma	WMA	WMA	<ul style="list-style-type: none">WMA supports up to 10 Pro 5.1 channel and M2 profile. (LBR mode of M0 is not supported)

❑ Media Contents - Additional Functions

Playing the selected Videos/Music/Photos files

1. Press the **TOOLS** button at each main screen and select **Play selection**.
2. Select the desired files.
 -  The check box appears to the left of the selected files.
3. Press the ► button to select **Play**.
 -  You can select or deselect all files pressing the **Select All / Deselect All**.

Videos/Music/Photos Play Option menu

During playing a file, press the **TOOLS** button.

Category	Operation	Videos	Photos	Music
Title Search	You can move the other file directly.	✓		
Time Search	You can search the video using ◀ and ▶ button at one minute interval or entering the number directly.  It may not be supported depending on the input source.	✓		
Repeat Mode	You can play movie files repeatedly.	✓		
Picture Size	You can adjust the picture size to your preference.	✓		
Picture Mode	You can adjust the picture setting.	✓	✓	
Sound Mode	You can adjust the sound setting.	✓	✓	

Category	Operation	Videos	Photos	Music
Audio Language	You can change the audio language if the video has more than one language.	✓		
Subtitle	You can set subtitles on/off.	✓		
Subtitle Settings	You can play the video with subtitles. This function only works if the subtitles are the same file name as the video.	✓		
Start Slide Show / Stop Slide Show	You can start or stop a slide show.		✓	
Slide Show Speed	You can select the slide show speed during the slide show.		✓	
Background Music On / Background Music Off	You can set on/off background music when watching a slide show.		✓	



Category	Operation	Videos	Photos	Music
Background Music Setting	You can select background music when watching a slide show.		✓	
Zoom	You can zoom into images in full screen mode.		✓	
Rotate	You can rotate images in full screen mode.		✓	
Edit playlist	You can edit the play list when playing the desired music.			✓
Play selection	Select and play multiple files.			✓
Information	You can see detailed information about the played file.	✓	✓	✓

❑ Using the DLNA Functions

for PDP 490 series

You can play media contents including videos, photos and music saved on your mobile phones or the other devices (such as your PC) by controlling them on the TV via the network.

- ✎ First, configure your network. For detailed procedures on using the Network Setup, refer to the “**Network Settings**” instructions.
- ✎ For more information, visit “www.samsung.com” or contact the Samsung call centre. Mobile devices may need additional software installation. For details, refer to each device’s user’s guide.
- ✎ If your Samsung TV connects to a non-Samsung DLNA server, a compatibility issue may occur during video playback.



- 
- By connecting your Samsung TV to a network via AllShare™, you can use Samsung's original functions as follows:
- Playback of various video formats (DivX, MP4, 3GPP, AVI, ASF, MKV, etc.)
 - Video thumbnail feature
 - Bookmark function (to resume video playback)
 - Auto-chaptering (scene navigation)
 - Digital content management
 - Compatibility with various subtitle formats (SRT, SMI, SUB, TXT, TTXT)
 - Search with file names
 - And many others
- 
- To use the original DLNA functions of Samsung fully, it is recommended that you use the AllShare™ software provided with your TV.

Playing the media contents saved on the devices

1. Connect the mobile phone or other devices which support **AllShare Play** function, and then play the media contents of each device. The popup screen appears on the bottom of your TV.
2. Select the **Allow** to accept the connected devices. The media contents of the devices can be playing on your TV.



 You can find the allowed devices on the **AllShare Settings**.

Using the **AllShare Play** function, play the media contents of the devices connected to DLNA function.

1. Press the **CONTENT** button to select **AllShare Play**.
2. Press **▲/▼** button to select desired menu (**Videos, Photos, Music**), then press the **ENTER**  button.
3. When the DLNA device is selected, press the **ENTER**  button again.
4. Press the **◀/▶/▲/▼** button to select the desired file.
5. Press the **ENTER**  button.



NOTE

- Contents may not be played on your TV depending on their resolution and format.
- The **ENTER**  and  buttons may not work depending on the type of media content.
- Using the mobile device, you can control the media playing. For details, refer to each mobile's user's guide.



Using the AllShare Settings function

 **MENU**  → **Network** → **AllShare Settings** → **ENTER** 

Shows a list of mobile phones or connected devices which have been set up with this TV for using the **AllShare Settings** function.

 The **AllShare Settings** function is available in all devices which support DLNA DMC.



- **Allow / Deny**: Allows/Blocks the devices.
- **Delete**: Deletes the devices from the list.







 This function only deletes the name of the devices from the list. If the deleted device is turned on or tries to connect to the TV, it may appear on the list again.



❑ Teletext Feature

The index page of the Teletext service gives you information on how to use the service. For Teletext information to be displayed correctly, channel reception must be stable. Otherwise, information may be missing or some pages may not be displayed.

You can change Teletext pages by pressing the numeric buttons on the remote control.

-  (mode): Selects the Teletext mode (LIST/FLOF). If pressed during LIST mode, switches the mode to List save mode. In List save mode, you can save a Teletext page into a list using the  (store) button.
-  (Teletext on/mix/off): Activates the Teletext mode for the current channel. Press the button twice to overlap the Teletext mode with the current broadcasting screen. Press it one more time to exit teletext.

-  (sub-page): Displays the available sub-page.
-  (store): Stores the Teletext pages.
-  (index): Displays the index (contents) page at any time while you are viewing Teletext.
-  (size): Displays the teletext on the upper half of the screen in double-size. To move the text to the lower half of the screen, press it again. For normal display, press it once again.
-  (hold): Holds the display at the current page, in the case that there are several secondary pages that follow automatically. To undo, press it again.
-  (page up): Displays the next Teletext page.
-  (page down): Displays the previous Teletext page.

-  (reveal): Displays the hidden text (answers to quiz games, for example). To display the normal screen, press it again.
-  (cancel): Shrinks the Teletext display to overlap with the current broadcast.
- Colour buttons (red, green, yellow, blue): If the FASTEXT system is used by the broadcasting company, the different topics on a Teletext page are colour-coded and can be selected by pressing the coloured buttons. Press the colour corresponding to the topic of your choice. A new colourcoded page is displayed. Items can be selected in the same way. To display the previous or next page, press the corresponding coloured button.

The Teletext pages are organized according to six categories:

Part	Contents
A	Selected page number.
B	Broadcasting channel identity.
C	Current page number or search indications.
D	Date and time.
E	Text.
F	Status information. FASTEXT information.

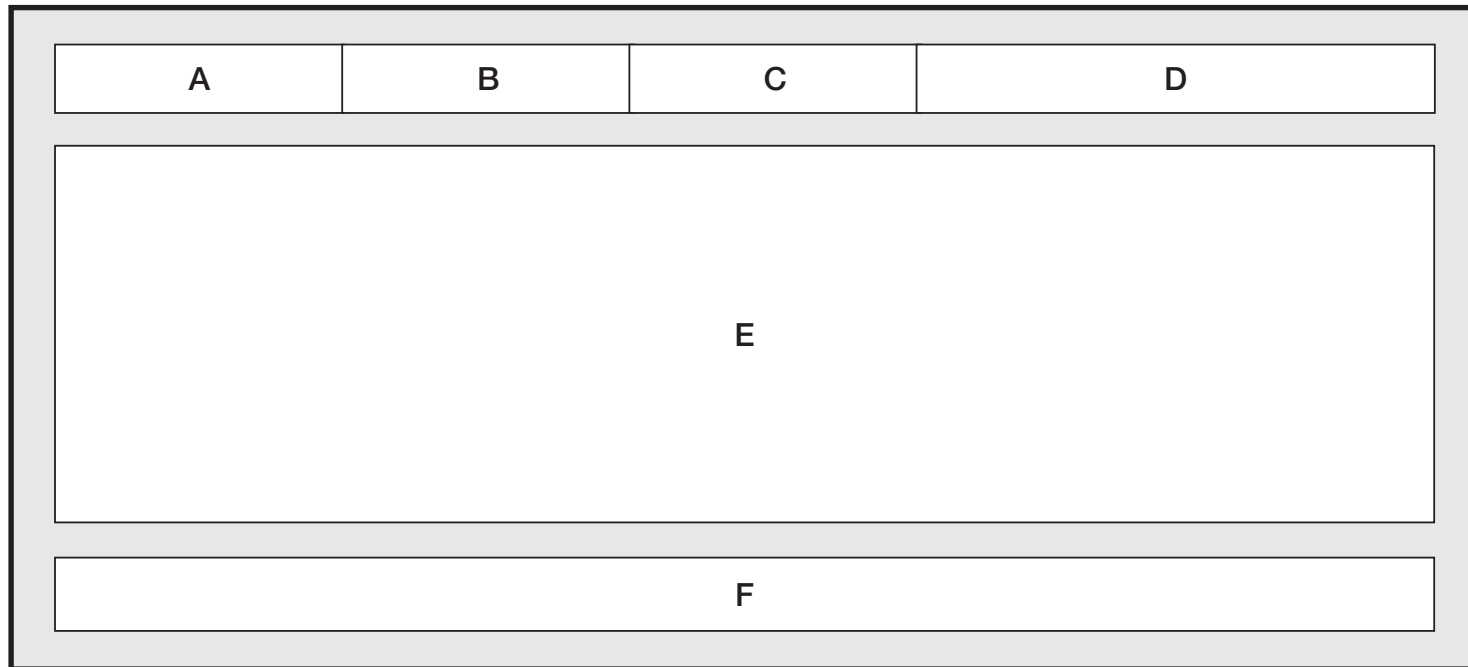

❑ Anti-theft Kensington Lock

The Kensington Lock is not supplied by Samsung. It is a device used to physically fix the system when using it in a public place. The appearance and locking method may differ from the illustration depending on the manufacturer. Refer to the manual provided with the Kensington Lock for additional information on proper use.



📖 Please find a “🔒” icon on the rear of the TV. A kensington slot is beside the “🔒” icon.

📖 The position and colour may differ depending on the model.

To lock the product, follow these steps:

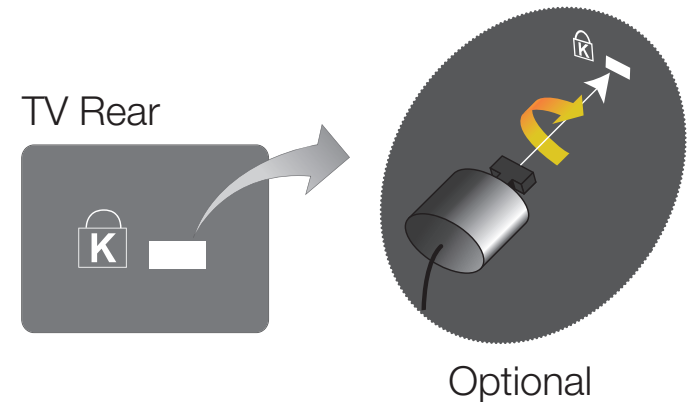
1. Wrap the Kensington lock cable around a large, stationary object such as desk or chair.



2. Slide the end of the cable with the lock attached through the looped end of the Kensington lock cable.
 3. Insert the locking device into the Kensington slot on the product.
 4. Lock the lock.
-  These are general instructions. For exact instructions, see the User manual supplied with the locking device.
-  The locking device has to be purchased separately.

❑ Connections Common Interface Slot

To watch paid channels, the “CI or CI+ CARD” must be inserted.

- If you do not insert the “CI or CI+ CARD”, some channels will display the message “Scrambled Signal”.
- The pairing information containing a telephone number, the “CI or CI+ CARD” ID, the Host ID and other information will be displayed in about 2~3 minutes. If an error message is displayed, please contact your service provider.
- When the configuration of channel information has finished, the message “Updating Completed” is displayed, indicating the channel list is updated.

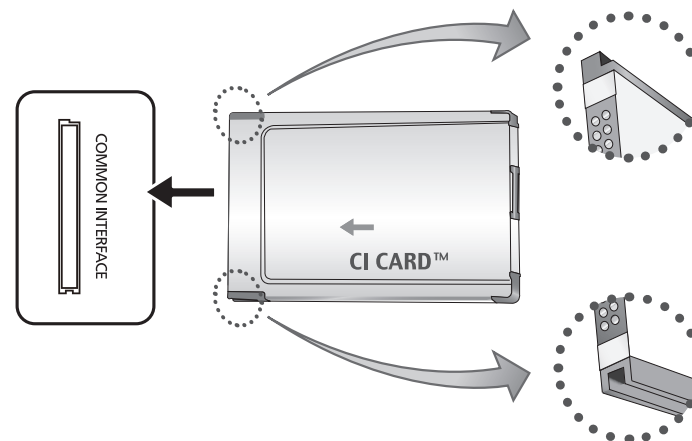

* The image may differ depending on the model.



NOTE

- You must obtain a “CI or CI+ CARD” from a local cable service provider.
- When removing the “CI or CI+ CARD”, carefully pull it out with your hands since dropping the “CI or CI+ CARD” may cause damage to it.
- Insert the “CI or CI+ CARD” in the direction marked on the card.
- The location of the COMMON INTERFACE slot may be different depending on the model.
- “CI or CI+ CARD” is not supported in some countries and regions; check with your authorized dealer.
- If you have any problems, please contact a service provider.
- Insert the “CI or CI+ CARD” that supports the current aerial settings. The screen will be distorted or will not be seen.

❑ Troubleshooting

If you have any questions about the TV, first refer to this list. If none of these troubleshooting tips apply, please visit “www.samsung.com”, then click on Support.

Issues	Solutions and Explanations
Picture Quality	First of all, please perform the Picture Test and confirm that your TV is properly displaying test image. (go to MENU - Support - Self Diagnosis - Picture Test) If the test image is properly displayed, the poor picture may be caused by the source or signal.

Issues	Solutions and Explanations
<p>The TV image does not look as good as it did in the store.</p>	<ul style="list-style-type: none">● If you have an analogue cable/set top box, upgrade to a digital set top box. Use HDMI or Component cables to deliver HD (high definition) picture quality. LCD 420 does not support AV, Component mode● Cable/Satellite subscribers: Try HD stations from the channel line up.● Aerial connection: Try HD stations after performing Auto tuning.● Many HD channels are up scaled from SD (Standard Definition) contents.● Adjust the Cable/Set top box video output resolution to 1080i or 720p.● Make sure you are watching the TV at the minimum recommended distance based on the size and definition of the signal.

Issues	Solutions and Explanations
The picture is distorted: macroblock error, small block, dots, pixelization	<ul style="list-style-type: none">● Compression of video contents may cause picture distortion especially in fast moving pictures such as sports and action movies.● Low signal level or bad quality can cause picture distortion. This is not a TV issue.● Mobile phones used close to the TV (cca up to 1m) may cause noise in picture on analogue and digital TV.
Colour is wrong or missing.	<ul style="list-style-type: none">● If you're using a component connection, make sure the component cables are connected to the correct jacks. Incorrect or loose connections may cause colour problems or a blank screen. LCD 420 does not support AV, Component mode

Issues	Solutions and Explanations
There is poor colour or brightness.	<ul style="list-style-type: none"> ● Adjust the Picture options in the TV menu. (go to Picture Mode / Colour / Brightness / Sharpness) ● Adjust Energy Saving option in the TV menu. (go to MENU - System - Eco Solution - Energy Saving) ● Try resetting the picture to view the default picture settings. (go to MENU - Picture - Reset Picture)
There is a dotted line on the edge of the screen.	<ul style="list-style-type: none"> ● If the picture size is set to Screen Fit, change it to 16:9. ● Change cable/satellite box resolution.
The picture is black and white.	<ul style="list-style-type: none"> ● If you are using an AV composite input, connect the video cable (yellow) to the Green jack of component input 1 on the TV. LCD 420 does not support AV, Component mode

Issues	Solutions and Explanations
When changing channels, the picture freezes or is distorted or delayed.	<ul style="list-style-type: none">● If connected with a cable box, please try to reset the cable box. Reconnect the AC cord and wait until the cable box reboots. It may take up to 20 minutes.● Set the output resolution of the cable box to 1080i or 720p.
Sound Quality	<p>First of all, please perform the Sound Test to confirm that your TV audio is properly operating. (go to MENU - Support - Self Diagnosis - Sound Test)</p> <p>If the audio is ok, the sound problem may caused by the source or signal.</p>
There is no sound or the sound is too low at maximum volume.	<ul style="list-style-type: none">● Please check the volume of the device (Cable/Sat Box, DVD, Blu-ray etc) connected to your TV.

Issues	Solutions and Explanations
<p>The picture is good but there is no sound.</p>	<ul style="list-style-type: none">● Set the Speaker Select option to TV Speaker in the sound menu. for LED, PDP TV● If you are using an external device, make sure the audio cables are connected to the correct audio input jacks on the TV.● If you are using an external device, check the device's audio output option (ex. you may need to change your cable box's audio option to HDMI when you have a HDMI connected to your TV).● If you are using a DVI to HDMI cable, a separate audio cable is required.● Reboot the connected device by reconnecting the device's power cable.● If your TV has a headphone jack, make sure there is nothing plugged into it.

Issues	Solutions and Explanations
The speakers are making an inappropriate noise.	<ul style="list-style-type: none">● Check the cable connections. Make sure a video cable is not connected to an audio input.● For aerial or cable connections, check the signal strength. Low signal level may cause sound distortion.
No Picture, No Video	
The TV will not turn on.	<ul style="list-style-type: none">● Make sure the AC power cord is securely plugged in to the wall outlet and the TV.● Make sure the wall outlet is working.● Try pressing the POWER button on the TV to make sure the problem is not the remote. If the TV turns on, refer to “The remote control does not work” below.

Issues	Solutions and Explanations
The TV turns off automatically.	<ul style="list-style-type: none">● Ensure the Sleep Timer is set to Off in the Time menu.● If your PC is connected to the TV, check your PC power settings.● Make sure the AC power cord is plugged in securely to the wall outlet and the TV.● When watching TV from an aerial or cable connection, the TV will turn off after 10 ~ 15 minutes if there is no signal.



Issues	Solutions and Explanations
There is no picture/ video.	<ul style="list-style-type: none">● Check cable connections (remove and reconnect all cables connected to the TV and external devices).● Set your external device's (Cable/Set top Box, DVD, Blu-ray etc) video outputs to match the connections to the TV input. For example, if an external device's output is HDMI, it should be connected to an HDMI input on the TV.● Make sure your connected devices are powered on.● Be sure to select the TV's correct source by pressing the SOURCE button on the remote control.● Reboot the connected device by reconnecting the device's power cable.

Issues	Solutions and Explanations
RF(Cable/Aerial) Connection	
The TV is not receiving all channels.	<ul style="list-style-type: none"> ● Make sure the Aerial cable is connected securely. ● Please try Setup (Initial setup) to add available channels to the channel list. Go to MENU - System - Setup (Initial setup) and wait for all available channels to be stored. ● Verify the Aerial is positioned correctly.
The picture is distorted: macro block error small block, dots, pixelization	<ul style="list-style-type: none"> ● Compression of video contents may cause picture distortion, especially on fast moving pictures such as sports and action movies. ● A low signal can cause picture distortion. This is not a TV issue.

Issues	Solutions and Explanations
Network Connection for PDP 490 series	
Software Upgrade over the network fails.	<ul style="list-style-type: none"> ● Try Network Settings in Network menu. ● If you have latest SW version, SW upgrade will not proceed.
Others	
The picture will not display in full screen.	<ul style="list-style-type: none"> ● HD channels will have black bars on either side of the screen when displaying up scaled SD (4:3) contents. ● Black bars on the top and bottom will appear during movies that have aspect ratios different from your TV. ● Adjust the picture size options on your external device or TV to full screen.

Issues	Solutions and Explanations
<p>Plasma TV is making humming noise.</p> <p>for PDP TV</p>	<ul style="list-style-type: none">● Plasma TVs typically make a soft humming sound. This is normal. It's caused by the electrical charges that are used to create the images on the screen.● If the humming sound is loud, you may have set the brightness on the TV too high. Try setting the brightness lower.● You can also have loud humming if the back of your Plasma TV is too close to a wall or other hard surface. Also try rerouting your connection cables.● Improper installation of wall mount can create excessive noise.
<p>Image Retention (Burn In) Issue.</p> <p>for PDP TV</p>	<ul style="list-style-type: none">● To minimize the possibility of screen burn, this unit is equipped with Pixel Shift screen burn reduction technology. Pixel Shift lets you set the picture so it moves slightly up and down (Vertical Line) and side to side (Horizontal Dot). The regular, slight movement of the picture reduces screen burn in.

Issues	Solutions and Explanations
The remote control does not work.	<ul style="list-style-type: none">● Replace the remote control batteries with the poles (+/-) in the right direction.● Clean the sensor's transmission window on the remote.● Try pointing the remote directly at the TV from 5~6 feet away.
The Cable/Set top box remote control doesn't turn the TV on or off, or adjust the volume.	<ul style="list-style-type: none">● Programme the Cable/Set top box remote control to operate the TV. Refer to the Cable/Set top box user manual for the SAMSUNG TV code.
A " Mode Not Supported " message appears.	<ul style="list-style-type: none">● Check the supported resolution of the TV, and adjust the external device's output resolution accordingly.

Issues	Solutions and Explanations
There is a plastic smell from the TV.	<ul style="list-style-type: none">● This smell is normal and will dissipate over time.
The TV Signal Information is unavailable in the Self Diagnosis Test menu.	<ul style="list-style-type: none">● This function is only available with digital channels from an Aerial / RF / Coax connection.
TV is tilted to the right or left side.	<ul style="list-style-type: none">● Remove the stand base from the TV and reassemble it.
There are difficulties assembling the stand base.	<ul style="list-style-type: none">● Make sure the TV is placed on a flat surface. If you can not remove the screws from the TV, please use a magnetized screw driver.

Issues	Solutions and Explanations
The Channel menu is grey out (unavailable).	<ul style="list-style-type: none"> ● The Channel menu is only available when the TV source is selected.
Your settings are lost after 30 minutes or every time the TV is turned off.	<ul style="list-style-type: none"> ● If the TV is in the Store Demo mode, it will reset audio and picture settings every 30 minutes. Change the settings from Store Demo mode to Home Use mode in the Setup (Initial setup) procedure. Press the SOURCE button to select TV mode, and go to MENU → System → Setup (Initial setup) → ENTER .
You have intermittent loss of audio or video.	<ul style="list-style-type: none"> ● Check the cable connections and reconnect them. ● Loss of audio or video can be caused by using overly rigid or thick cables. Make sure the cables are flexible enough for long term use. If mounting the TV to the wall, we recommend using cables with 90 degree connectors.

Issues	Solutions and Explanations
<p>You see small particles when you look closely at the edge of the frame of the TV.</p>	<ul style="list-style-type: none"> ● This is part of the product's design and is not a defect.
<p>The PIP menu is not available.</p>	<ul style="list-style-type: none"> ● PIP functionality is only available when you are using a HDMI or components source. LCD 420 does not support AV, Component mode
<p>You turned the TV off 45 minutes ago, and it turned on again.</p>	<ul style="list-style-type: none"> ● It is normal. The TV operates the OTA (Over The Aerial) function itself to upgrade firmware downloaded whilst your watching TV.
<p>The message "Scrambled Signal" or "Weak or No Signal" appears.</p>	<ul style="list-style-type: none"> ● If you are using a CAM CARD (CI/CI+), check that it is installed into the common interface slot. ● If there is still a problem, pull the CAM CARD out of the TV and insert it into the slot again.

Issues	Solutions and Explanations
There are recurrent picture/sound issues.	<ul style="list-style-type: none">● Check and change the signal/source.
A reaction may occur between the rubber cushion pads on the base stand and the top finish of some furniture.	<ul style="list-style-type: none">● To prevent this, use felt pads on any surface of the TV that comes in direct contact with furniture.
The message “ This file may not be playable properly. ” appears.	<ul style="list-style-type: none">● This may appear because of high bit rate of content. Content generally will play but could experience some playability issue.

❑ Licence



TheaterSound, SRS and  symbol are trademarks of SRS Labs, Inc.
TheaterSound technology is incorporated under license from SRS Labs, Inc.

SRS TheaterSound™ provides the most immersive surround sound experience from the TVs built-in speakers, while maintaining steady volume and delivering rich bass and clear dialog.



Manufactured under license from Dolby Laboratories. Dolby and the double-D symbol are trademarks of Dolby Laboratories.



Manufactured under license under U.S. Patent Nos: 5,956,674; 5,974,380; 6,487,535 & other U.S. and worldwide patents issued & pending. DTS, the Symbol, & DTS and the Symbol together are registered trademarks & DTS 2.0+Digital Out is a trademark of DTS, Inc. Product includes software. © DTS, Inc. All Rights Reserved.



Manufactured under license under U.S. Patent Nos: 5,956,674; 5,974,380; 6,487,535 & other U.S. and worldwide patents issued & pending. DTS, the Symbol & DTS and the Symbol together are registered trademarks & DTS 2.0 Channel is a trademark of DTS, Inc. Product includes software. © DTS, Inc. All Rights Reserved.

Only for LCD 420 series



The terms HDMI and HDMI High-Definition Multimedia Interface, and the HDMI Logo are trademarks or registered trademarks of HDMI Licensing LLC in the United States and other countries.



DivX Certified® to play DivX® video up to HD 1080p, including premium content.

ABOUT DIVX VIDEO: DivX® is a digital video format created by DivX, LLC, a subsidiary of Rovi Corporation. This is an official DivX Certified® device that plays DivX video. Visit divx.com for more information and software tools to convert your files into DivX videos.

ABOUT DIVX VIDEO-ON-DEMAND: This DivX Certified® device must be registered in order to play purchased DivX Video-on-Demand (VOD) movies. To obtain your registration code, locate the DivX VOD section in your device setup menu. Go to vod.divx.com for more information on how to complete your registration. Covered by one or more of the following U.S. patents : 7,295,673; 7,460,668; 7,515,710; 7,519,274

DivX®, DivX Certified® and associated logos are trademarks of Rovi Corporation or its subsidiaries and are used under license.

Open Source Licence Notice

In the case of using open source software, Open Source Licences are available on the product menu. Open Source Licence Notice is written only English.